

Introduction

The sigma delta conversion technique has been in existence for many years, but recent technological advances now make the devices practical and their use is becoming widespread. The converters have found homes in such applications as communications systems, consumer and professional audio, industrial weight scales, and precision measurement devices. The key feature of these converters is that they are the only low cost conversion method which provides both high dynamic range and flexibility in converting low bandwidth input signals. This application note is intended to give an engineer with little or no sigma delta background an overview of how a sigma delta converter works.

The following are brief definitions of terms that will be used in this application note:

Noise Shaping Filter or Integrator: The noise shaping filter or integrator of a sigma delta converter distributes the converter quantization error or noise such that it is very low in the band of interest.

Oversampling. Oversampling is simply the act of sampling the input signal at a frequency much greater than the Nyquist frequency (two times the input signal bandwidth). Oversampling decreases the quantization noise in the band of interest.

Digital Filter. An on-chip digital filter is used to attenuate signals and noise that are outside the band of interest.

Decimation: Decimation is the act of reducing the data rate down from the oversampling rate without losing information.

Discussion

Figure 1 shows a simple block diagram of a first order sigma delta Analog-to-Digital Converter (ADC). The input signal X comes into the modulator via a summing junction. It then passes through the integrator which feeds a comparator that acts as a one-bit quantizer. The comparator output is fed back to the input summing junction via a one-bit digital-to-analog converter (DAC), and it also passes through the digital filter and emerges at the output of the converter. The feedback loop forces the average of the signal W to be equal to the input signal X. A quick review of quantization noise theory and signal sampling theory will be useful before diving deeper into the sigma delta converter.

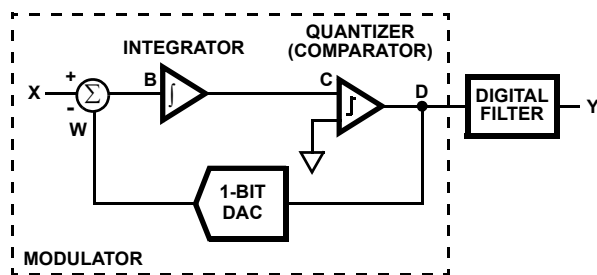

FIGURE 1. FIRST ORDER SIGMA DELTA ADC BLOCK DIAGRAM

Signal Sampling

The sampling theorem states that the sampling frequency of a signal must be at least twice the signal frequency in order to recover the sampled signal without distortion. When a signal is sampled its input spectrum is copied and mirrored at multiples of the sampling frequency f_s . Figure 2A shows the spectrum of a sampled signal when the sampling frequency f_s is less than twice the input signal frequency $2f_0$. The shaded area on the plot shows what is commonly referred to as aliasing which results when the sampling theorem is violated. Recovering a signal contaminated with aliasing results in a distorted output signal. Figure 2B shows the spectrum of an oversampled signal. The oversampling process puts the entire input bandwidth at less than $f_s/2$ and avoids the aliasing trap.^[1]

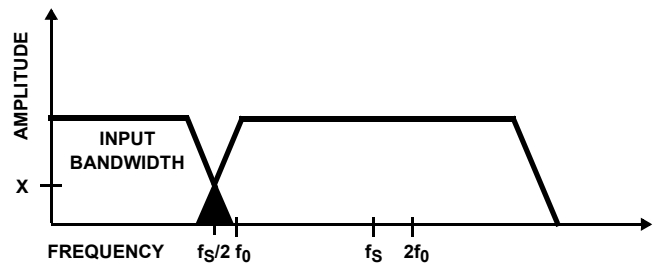

FIGURE 2A. UNDERSAMPLED SIGNAL SPECTRUM

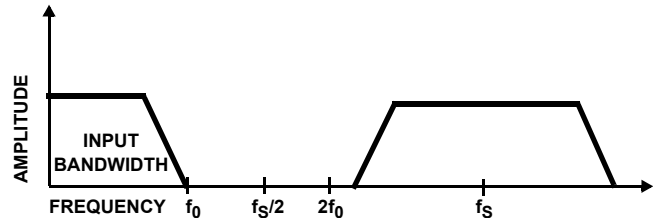

FIGURE 2B. OVERSAMPLED SIGNAL SPECTRUM

Quantization Noise

Quantization noise (or quantization error) is one limiting factor for the dynamic range of an ADC. This error is actually the "round-off" error that occurs when an analog signal is quantized. For example, Figure 3 shows the output codes and corresponding input voltages for a 2-bit A/D converter with a 3V full scale value. The figure shows that input values of 0V, 1V, 2V, and 3V correspond to digital output codes of 00, 01, 10, and 11 respectively. If an input of 1.75V is applied to this converter, the resulting output code would be 10 which corresponds to a 2V input. The 0.25V error (2V - 1.75V) that occurs during the quantization process is called the quantization error. Assuming the quantization error is random, which is normally true, the quantization error can be treated as random or white noise. Therefore, the quantization noise power and RMS quantization voltage for an A/D converter are given by the following equations:

$$e^2_{RMS} = \frac{1}{q} \int_{-q/2}^{q/2} e^2 de = \frac{q^2}{12} \quad (V^2) \quad (EQ. 1)$$

$$e_{RMS} = \frac{q}{\sqrt{12}} \quad (V) \quad (EQ. 2)$$

where q is the quantization interval or LSB size (see Figure 3).

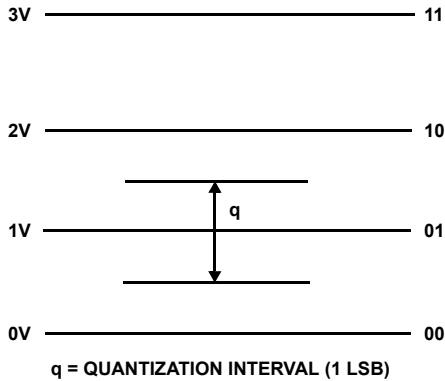

FIGURE 3. CODE EXAMPLE OF A 2-BIT A/D CONVERTER

As an example, the RMS quantization noise for a 12-bit ADC with a 2.5V full scale value is 176µV.

A quantized signal sampled at frequency f_S has all of its noise power folded into the frequency band of $0 \leq f \leq f_S/2$. Assuming once again that this noise is random, the spectral density of the noise is given by:

$$E(f) = e_{RMS} \left(\frac{2}{f_S}\right)^{\frac{1}{2}} \left(\frac{V}{\sqrt{Hz}}\right) \quad (EQ. 3)$$

Converting this to noise power by squaring it and integrating over the bandwidth of interest (f_0), we get the following result:

$$n_0^2 = e^2_{RMS} \left(\frac{2f_0}{f_S}\right) \quad (V^2) \quad (EQ. 4)$$

$$n_0 = e_{RMS} \left(\frac{2f_0}{f_S}\right)^{\frac{1}{2}} \quad (V) \quad (EQ. 5)$$

where n_0 is the in-band quantization noise, f_0 is the input signal bandwidth, and f_S is the sampling frequency. The quantity $f_S/2f_0$ is generally referred to as the Oversampling Ratio or OSR. It is important to note that Equation 5 above shows that oversampling reduces the in band quantization noise by the square root of the OSR.^[2]

Sigma Delta Modulator Quantization Noise

The results of the above sampling and noise theory can now be used to show how a sigma delta modulator shapes quantization noise. Figure 4 shows the sampled data equivalent block diagram of a first order sigma delta modulator. The difference equation for the output of the modulator is given by:

$$y_i = x_{i-1} + (e_i - e_{i-1}) \quad (EQ. 6)$$

where e is the quantization noise.

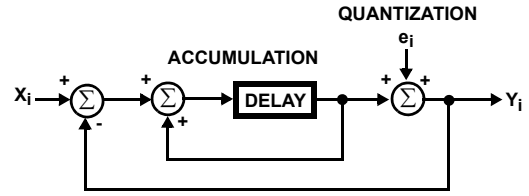

FIGURE 4. FIRST ORDER SIGMA DELTA MODULATOR SAMPLED DATA EQUIVALENT BLOCK DIAGRAM

Assuming the input signal is active enough to treat the error as white noise, the spectral density of the noise ($n_i = e_i - e_{i-1}$) can be expressed as

$$N(f) = E(f) \left| 1 - e^{-j\omega/f_S} \right| = 2 e_{RMS} \left(\frac{2}{f_S}\right)^{\frac{1}{2}} \sin\left(\frac{\omega}{2f_S}\right) \left(\frac{V}{\sqrt{Hz}}\right) \quad (EQ. 7)$$

The noise power in the bandwidth of interest is

$$n_0^2 = e^2_{RMS} \frac{\pi^2}{3} \left(\frac{2f_0}{f_S}\right)^3 \quad (V^2) \quad (EQ. 8)$$

or

$$n_0 = e_{RMS} \frac{\pi}{\sqrt{3}} \left(\frac{2f_0}{f_S}\right)^{\frac{3}{2}} \quad (V) \quad (EQ. 9)$$

This means that increasing f_S (which by default increases the OSR) by a factor of 2 will decrease the in band noise by 9dB. Taking this one step further shows that for the second order modulator shown in Figure 5 the noise is

$$n_0 = e_{RMS} \left(\frac{\pi^2}{\sqrt{5}}\right) \left(\frac{2f_0}{f_S}\right)^{\frac{5}{2}} \quad (V) \quad (EQ. 10)$$

and that increasing f_S by a factor of 2 decreases the in band noise by 15dB. In fact, the generalized formula for the noise of an Mth order modulator is

$$n_0 = e_{RMS} \left(\frac{\pi^M}{\sqrt{2M+1}}\right) \left(\frac{2f_0}{f_S}\right)^{M+\frac{1}{2}} \quad (V) \quad (EQ. 11)$$

and doubling the sampling frequency will decrease the in-band quantization noise by $3(2M+1)$ dB.^[3]

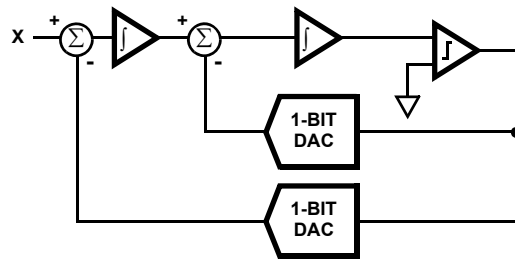

FIGURE 5. SECOND ORDER SIGMA DELTA MODULATOR

Figure 6 depicts the relationship between quantization noise, OSR, and modulator order by showing the signal to noise ratio (SNR) vs the OSR for a first, second, and third order modula-

tor. The graph illustrates that as the OSR increases, the noise decreases (SNR increases) and that as the order of the modulator increases, the noise decreases.

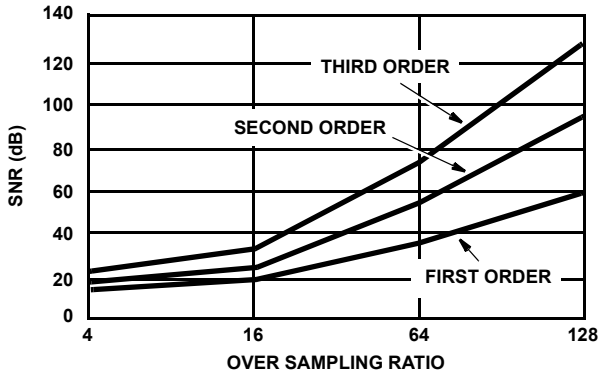

FIGURE 6. SNR vs OVERSAMPLING RATIO FOR SIGMA DELTA MODULATORS

The noise shaping attributes of the sigma delta modulator can be shown graphically as in Figure 7. Figure 7A shows the quantization noise spectrum of a typical Nyquist type converter and the theoretical SNR of such a converter. Figure 7B shows the effects of oversampling. $f_s/2$ is much greater than $2f_0$ and the quantization noise is spread over a wider spectrum. The total quantization noise is still the same but the quantization noise in the bandwidth of interest is greatly reduced. Figure 7C illustrates the noise shaping of the oversampled sigma delta modulator. Again the total quantization noise of the converter is the same as in Figure 7A, but the in-band quantization noise is greatly reduced.

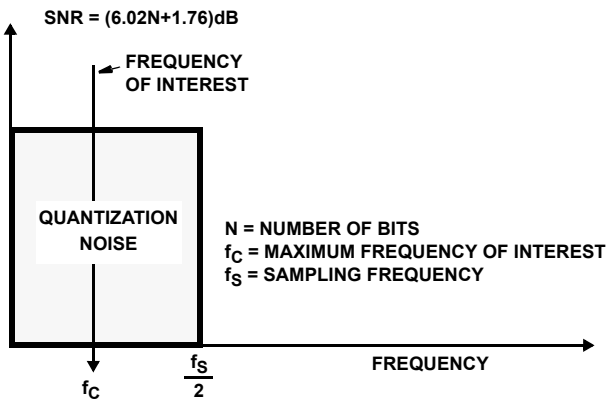

FIGURE 7A. NYQUIST CONVERTER QUANTIZATION NOISE SPECTRUM

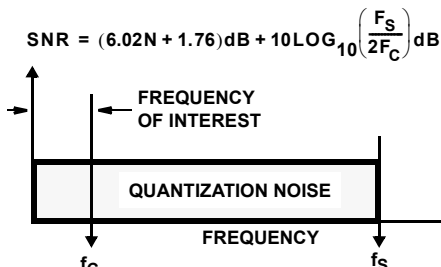

FIGURE 7B. OVERSAMPLED CONVERTER QUANTIZATION NOISE SPECTRUM

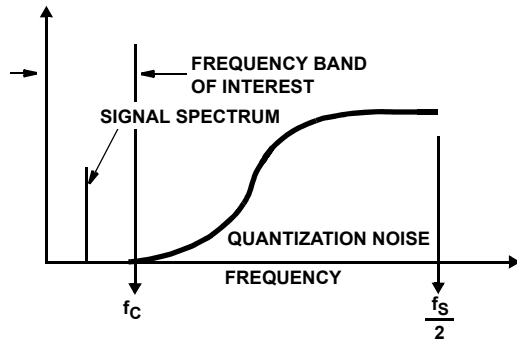

FIGURE 7C. OVERSAMPLED 1ST ORDER SIGMA DELTA QUANTIZATION NOISE SPECTRUM

Another way to examine the characteristics of the sigma delta modulator is to model it in the frequency domain. Figure 8 shows a linearized model of a sigma delta modulator. The integrator has been replaced with a filter whose transfer function is $H(s) = 1/s$ and the quantizer is modelled as a noise source whose noise contribution is $N(s)$. Letting $N(s) = 0$ for the moment, and solving for $Y(s)/X(s)$ results in the following:

$$Y(s) = [X(s) - Y(s)] \left[\frac{1}{s} \right] \tag{EQ. 12}$$

$$\frac{Y(s)}{X(s)} = \frac{1/s}{1 + 1/s} = \frac{1}{s + 1} \tag{EQ. 13}$$

By letting the signal $X(s) = 0$ and solving for $Y(s)/N(s)$ the following results are obtained:

$$Y(s) = -Y(s) \left[\frac{1}{s} \right] + N(s) \tag{EQ. 14}$$

$$\frac{Y(s)}{N(s)} = \frac{1}{1 + 1/s} = \frac{s}{s + 1} \tag{EQ. 15}$$

Examining Equations 13 and 15 above shows that indeed the modulator acts as a low pass filter for the input signal and a high pass filter for noise.

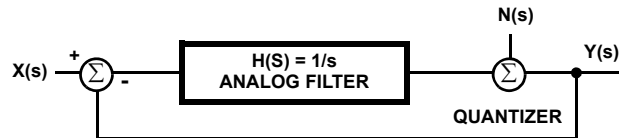

FIGURE 8. LINEARIZED MODEL OF 1ST ORDER SIGMA DELTA MODULATOR

Perhaps the best way to see the noise shaping characteristics of a sigma delta modulator is to look at the output spectrum of an actual modulator. Figure 9 shows the block diagram for the modulator portion of the Intersil HI7190 sigma delta ADC. This modulator is a fully differential sampled data (switched capacitor) second order modulator where only one DAC is used to feed back the modulator output signal to the two summing junctions. A spectral plot of the HI7190 output is shown in Figure 10. The figure shows the classic noise shaping characteristics of a sigma delta modulator that have been discussed thus far.

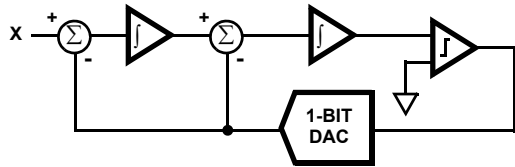

FIGURE 9. HI7190 2ND ORDER SIGMA DELTA MODULATOR

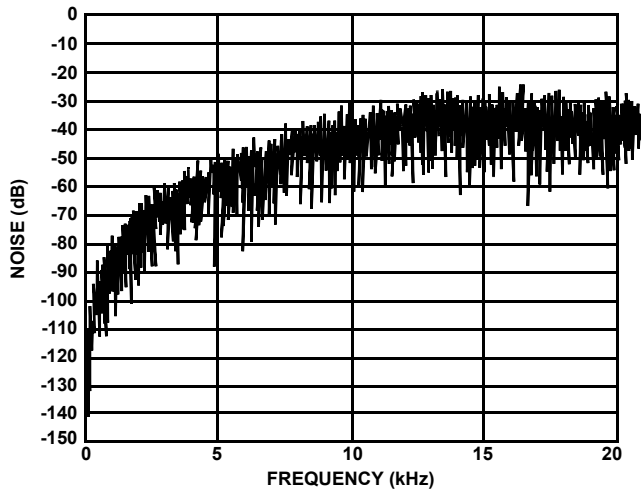

FIGURE 10. HI7190 SPECTRAL PLOT

Referring back to the block diagram of Figure 1, it is seen that after the input signal passes through the modulator it is fed into the digital filter. The function of the digital filter is to provide a sharp cutoff at the bandwidth of interest which essentially removes out of band quantization noise and signals. Figure 11 shows that the digital filter eliminates the quantization noise that the modulator pushed out to the higher frequencies.

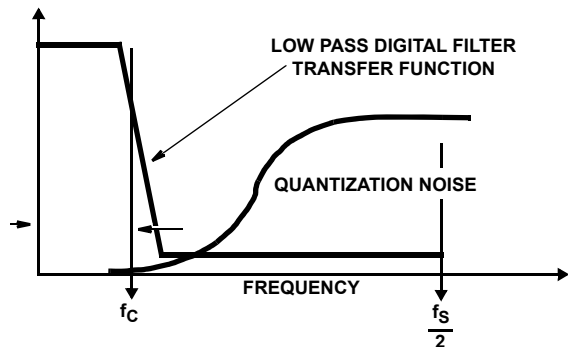

FIGURE 11A. BEFORE FILTERING

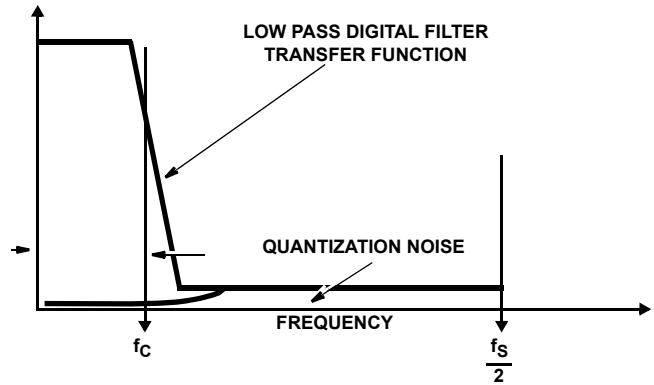

FIGURE 11B. AFTER FILTERING

FIGURE 11. IN-BAND QUANTIZATION NOISE BEFORE AND AFTER DIGITAL FILTERING

Sigma Delta Conversion Example

Before leaving the discussion of sigma delta modulators it would be useful to show a quick conversion example. Referring to Table 1 the table headings X, B, C, D, and W correspond to points in the signal path of the block diagram of Figure 1. For this example the input X is a DC input of 3/8. The resultant signal at each point in the signal path for each signal sample is shown in Table 1. Note that a repetitive pattern develops every sixteen samples and that the average of the signal W over samples 1 to 16 is 3/8 thus showing that the feedback loop forces the average of the feedback signal W to be equal to the input X.

TABLE 1. CONVERSION EXAMPLE

SAMPLE (n)	X (INPUT)	B (A-W _{n-1})	C (B+C _{n-1})	D (0 or 1)	W (-1 or +1)
0	3/8	0	0	0	0
1	3/8	3/8	3/8	1	+1
2	3/8	-5/8	-2/8	0	-1
3	3/8	11/8	9/8	1	+1
4	3/8	-5/8	4/8	1	+1
5	3/8	-5/8	-1/8	0	-1
6	3/8	11/8	10/8	1	+1
7	3/8	-5/8	5/8	1	+1
8	3/8	-5/8	0/8	0	-1
9	3/8	11/8	11/8	1	+1
10	3/8	-5/8	6/8	1	+1
11	3/8	-5/8	1/8	1	+1
12	3/8	-5/8	-4/8	0	-1
13	3/8	11/8	7/8	1	+1
14	3/8	-5/8	2/8	1	+1
15	3/8	-5/8	-3/8	0	-1
16	3/8	11/8	8/8	1	+1
17	3/8	-5/8	3/8	1	+1
18	3/8	-5/8	-2/8	0	-1

Introduction to Z-Transforms

Z transforms are often mentioned when digital filters are discussed and they can be intimidating to those not familiar with them. However, a few pictures and equations showing the relationships between the Laplace and z transforms along with a z transform example should help to reduce the intimidation factor.

The following equations provide a simple (and not rigorous) method for observing the relationships of the Laplace and z transforms:

$$F(s) = \int_0^{\infty} e^{-st} f(t) dt \tag{EQ. 16A}$$

$$F(z) = \sum_{n=0}^{\infty} f(nt) z^{-n} \tag{EQ. 16B}$$

$$s = j\omega \tag{EQ. 17A}$$

$$z = e^{j\omega t} \tag{EQ. 17B}$$

$$F(j\omega) = \int_0^{\infty} e^{-j\omega t} f(t) dt \tag{EQ. 18A}$$

$$F(z) = \sum_{n=0}^{\infty} f(nt) e^{-j\omega nt} \tag{EQ. 18B}$$

Equations 16A and 16B show the definitions of the two transforms. For the Laplace transform s is defined to be $j\omega$ while for the z transform z is defined as $e^{j\omega t}$. Substituting these values into 16A and 17A respectively result in Equations 18A and 18B. These last two equations show that the two transforms are actually very similar with the difference being the Laplace transform is a continuous summation of a continuous signal and the z transform is a discrete summation of a sampled signal.

Figure 12 graphically defines the relationships between the s and z planes. It is important to note the following:

1. The left half of the s plane maps within the unit circle of the z plane.
2. The distance f_s along the real frequency axis of the s plane wraps once around the unit circle in the z plane.
3. Any pole outside of the unit circle in the z plane means the system is unstable.
4. First order poles on the unit circle of the z plane imply marginally stable terms but multiple order poles on the unit circle imply an unstable system.
5. Poles inside the unit circle of the z plane represent stable terms.
6. Zeros can appear anywhere in the z plane without affecting system stability.

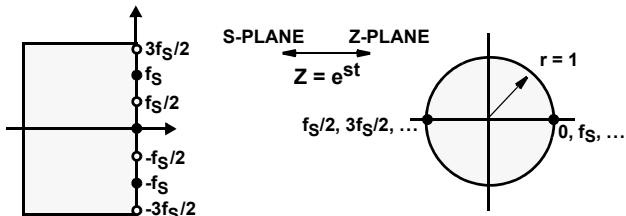

FIGURE 12. S PLANE AND Z PLANE MAPPING

It is also important to note that a z^{-1} term in the z domain translates to a unit time delay in the time domain.^[4]

Figure 13 shows an arbitrary block diagram for a z transform example. From the figure it is seen that

$$8x - 3Yz^{-1} + 2Yz^{-2} = Y. \tag{EQ. 19}$$

Solving for Y/X, the transfer function of the example is

$$\frac{Y}{X} = \frac{8z^2}{z^2 + 3z - 2}. \tag{EQ. 20}$$

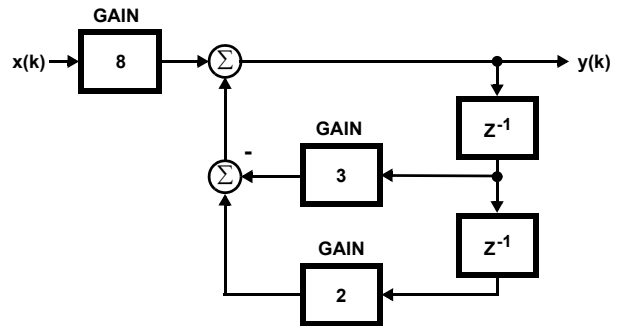

FIGURE 13. ARBITRARY Z-TRANSFORM EXAMPLE

This system has a second order zero at $z = 0$ and two poles; one at $z = 0.562$, and one at $z = -3.562$.

The above brief introduction to the z transform leads to a quick discussion of digital filters.

Digital Filters

There are two types of digital filters:

- Finite Impulse Response (FIR) filter, also known as a non-recursive filter, represented by

$$y(n) = \sum_{k=0}^M a_k x(n-k). \tag{EQ. 21}$$

- Infinite Impulse Response (IIR) filter, also known as a recursive filter, whose response is given by

$$y(n) = \sum_{k=0}^M a_k x(n-k) + \sum_{k=0}^N b_k y(n-k). \tag{EQ. 22}$$

Note that the difference between these two types of filters is for the FIR the output $y(n)$ is dependent only on past and present values of the input. However, the output $y(n)$ for the IIR filter is dependent on past and present values of both the input and the output.

Figure 14 shows a block diagram example and derived transfer functions of a FIR filter and an IIR filter. The advantages and disadvantages of these filters are given in table 1. The filter most commonly used for the back end of a sigma delta converter is the FIR because of its stability, ease of implementation, linear phase response, and the fact that decimation can be incorporated into the filter itself.

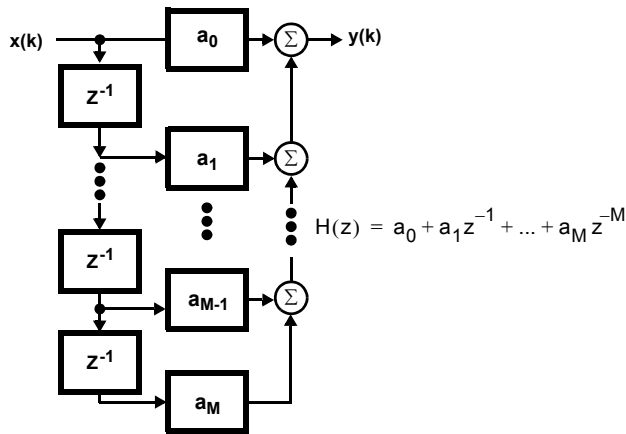

FIGURE 14A. FIR FILTER BLOCK DIAGRAM

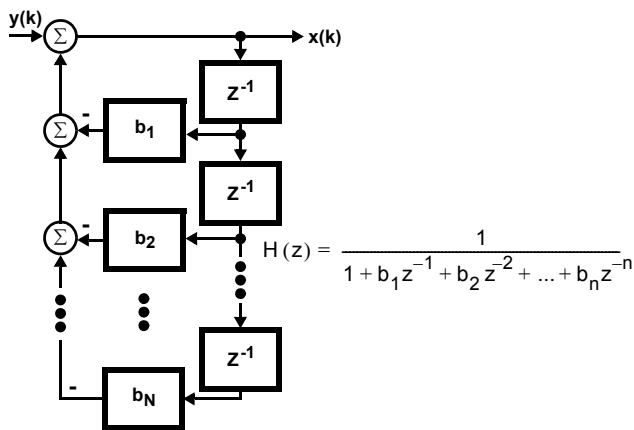

FIGURE 14B. IIR FILTER BLOCK DIAGRAM

TABLE 2. FIR vs IIR FILTERS

FIR FILTERS	IIR FILTERS
Easy to Design	More Difficult to Design
Always Stable	May be Unstable
Linear Phase Response	Nonlinear Phase Response
Easy to Incorporate Decimation	Can not Incorporate Decimation
Less Efficient	More Efficient

Decimation

The process of decimation is used in a sigma delta converter to eliminate redundant data at the output. The sampling theorem tells us that the sample rate only needs to be 2 times the input signal bandwidth in order to reliably reconstruct the input signal without distortion. However, the input signal was grossly over-sampled by the sigma delta modulator in order to reduce the quantization noise. Therefore, there is redundant data that can be eliminated without introducing distortion to the conversion result. The decimation process is shown in both the frequency and time domains in Figure 15. Both Figures 15A and 15B show that the decimation process simply reduces the output sample rate while retaining the necessary information.

As an example, the HI7190 uses a FIR comb filter with a sinc³ transfer function. The decimation rate is programmable from 10 to 2000 and notch frequencies range from 10Hz to 2kHz. This filter has shown >120dB of 50Hz and 60Hz rejection.

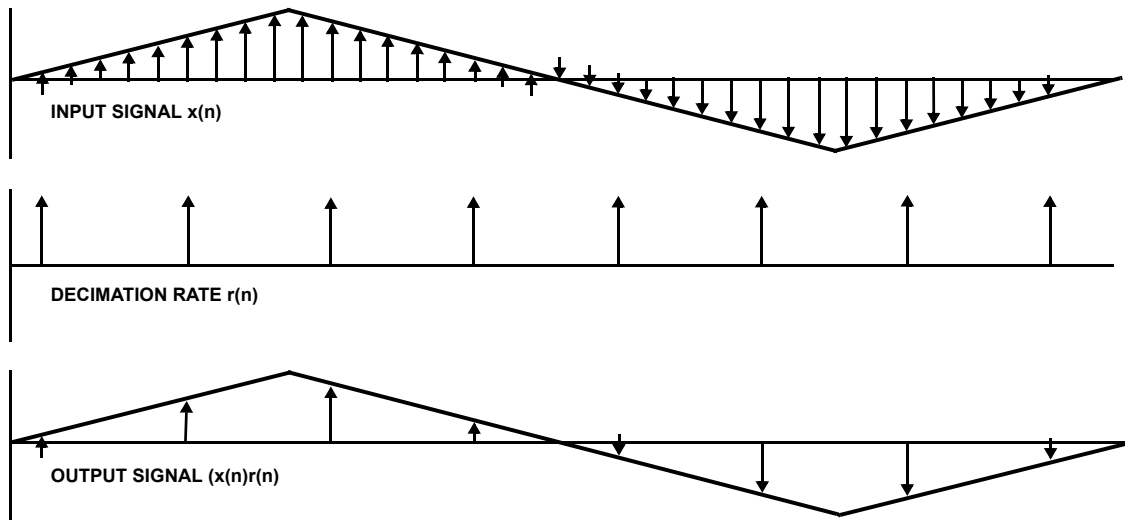

FIGURE 15A. DECIMATION IN THE TIME DOMAIN

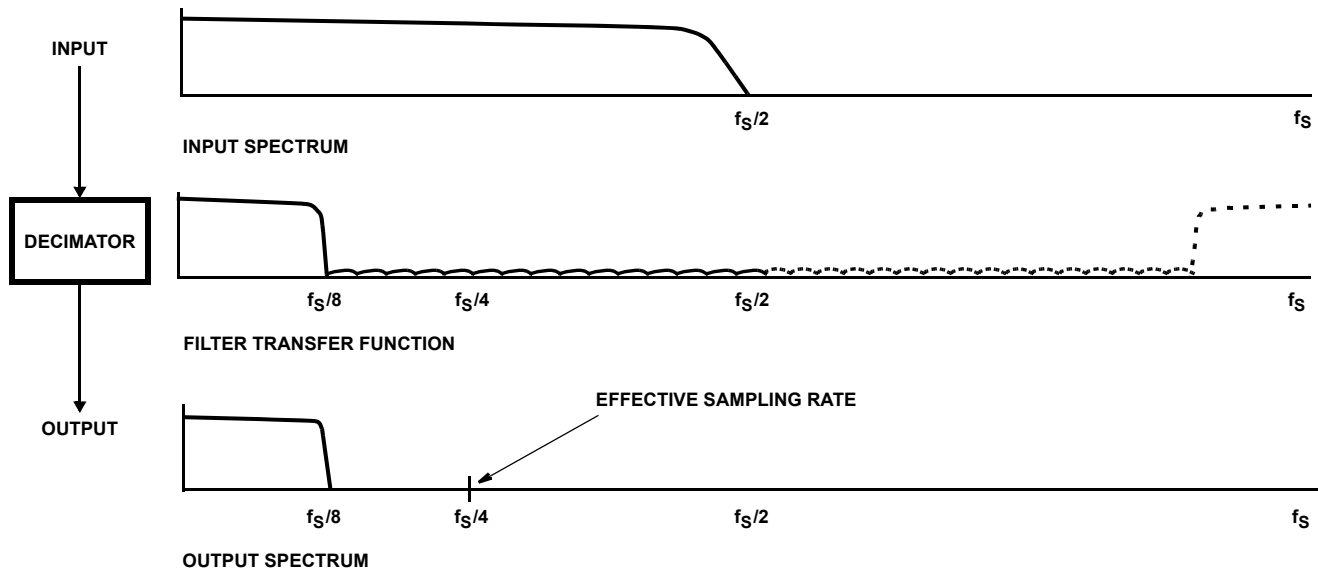

FIGURE 15B. DECIMATION BY 4 IN THE FREQUENCY DOMAIN

Summary

In summary this application note has been a very brief introduction to the world of sigma delta conversion. The sampling theorem and quantization noise theory were reviewed and it was shown that a sigma delta converter grossly oversamples the input signal and shapes the noise spectrum such that the modulator appears to be a high pass filter for the noise and a low pass filter for the input signal. The relationships between the Laplace and z transforms were discussed and the two transforms were found to be very similar. The two types of digital filters were introduced and their properties as they apply to sigma delta conversion were analyzed. Finally, the concept of decimation (or data rate reduction) was introduced along with the fact that decimation can easily be incorporated into an FIR filter structure.

References

- [1] Alexander D. Poularikas, Samuel Seely, "Signals and Systems," Massachusetts, PWS, 1985. p. 373-374.
- [2] James C. Candy, Gabor C. Temes. "Oversampling Methods for A/D D/A Conversion, Oversampling Delta-Sigma Converters," New Jersey, IEEE Press, 1992., p. 2-3.
- [3] Candy and Temes, p. 3-7.
- [4] Poularikas and Seely, p. 480.

Notice

1. Descriptions of circuits, software and other related information in this document are provided only to illustrate the operation of semiconductor products and application examples. You are fully responsible for the incorporation or any other use of the circuits, software, and information in the design of your product or system. Renesas Electronics disclaims any and all liability for any losses and damages incurred by you or third parties arising from the use of these circuits, software, or information.
2. Renesas Electronics hereby expressly disclaims any warranties against and liability for infringement or any other claims involving patents, copyrights, or other intellectual property rights of third parties, by or arising from the use of Renesas Electronics products or technical information described in this document, including but not limited to, the product data, drawings, charts, programs, algorithms, and application examples.
3. No license, express, implied or otherwise, is granted hereby under any patents, copyrights or other intellectual property rights of Renesas Electronics or others.
4. You shall not alter, modify, copy, or reverse engineer any Renesas Electronics product, whether in whole or in part. Renesas Electronics disclaims any and all liability for any losses or damages incurred by you or third parties arising from such alteration, modification, copying or reverse engineering.
5. Renesas Electronics products are classified according to the following two quality grades: "Standard" and "High Quality". The intended applications for each Renesas Electronics product depends on the product's quality grade, as indicated below.
"Standard": Computers; office equipment; communications equipment; test and measurement equipment; audio and visual equipment; home electronic appliances; machine tools; personal electronic equipment; industrial robots; etc.
"High Quality": Transportation equipment (automobiles, trains, ships, etc.); traffic control (traffic lights); large-scale communication equipment; key financial terminal systems; safety control equipment; etc.
Unless expressly designated as a high reliability product or a product for harsh environments in a Renesas Electronics data sheet or other Renesas Electronics document, Renesas Electronics products are not intended or authorized for use in products or systems that may pose a direct threat to human life or bodily injury (artificial life support devices or systems; surgical implantations; etc.), or may cause serious property damage (space system; undersea repeaters; nuclear power control systems; aircraft control systems; key plant systems; military equipment; etc.). Renesas Electronics disclaims any and all liability for any damages or losses incurred by you or any third parties arising from the use of any Renesas Electronics product that is inconsistent with any Renesas Electronics data sheet, user's manual or other Renesas Electronics document.
6. When using Renesas Electronics products, refer to the latest product information (data sheets, user's manuals, application notes, "General Notes for Handling and Using Semiconductor Devices" in the reliability handbook, etc.), and ensure that usage conditions are within the ranges specified by Renesas Electronics with respect to maximum ratings, operating power supply voltage range, heat dissipation characteristics, installation, etc. Renesas Electronics disclaims any and all liability for any malfunctions, failure or accident arising out of the use of Renesas Electronics products outside of such specified ranges.
7. Although Renesas Electronics endeavors to improve the quality and reliability of Renesas Electronics products, semiconductor products have specific characteristics, such as the occurrence of failure at a certain rate and malfunctions under certain use conditions. Unless designated as a high reliability product or a product for harsh environments in a Renesas Electronics data sheet or other Renesas Electronics document, Renesas Electronics products are not subject to radiation resistance design. You are responsible for implementing safety measures to guard against the possibility of bodily injury, injury or damage caused by fire, and/or danger to the public in the event of a failure or malfunction of Renesas Electronics products, such as safety design for hardware and software, including but not limited to redundancy, fire control and malfunction prevention, appropriate treatment for aging degradation or any other appropriate measures. Because the evaluation of microcomputer software alone is very difficult and impractical, you are responsible for evaluating the safety of the final products or systems manufactured by you.
8. Please contact a Renesas Electronics sales office for details as to environmental matters such as the environmental compatibility of each Renesas Electronics product. You are responsible for carefully and sufficiently investigating applicable laws and regulations that regulate the inclusion or use of controlled substances, including without limitation, the EU RoHS Directive, and using Renesas Electronics products in compliance with all these applicable laws and regulations. Renesas Electronics disclaims any and all liability for damages or losses occurring as a result of your noncompliance with applicable laws and regulations.
9. Renesas Electronics products and technologies shall not be used for or incorporated into any products or systems whose manufacture, use, or sale is prohibited under any applicable domestic or foreign laws or regulations. You shall comply with any applicable export control laws and regulations promulgated and administered by the governments of any countries asserting jurisdiction over the parties or transactions.
10. It is the responsibility of the buyer or distributor of Renesas Electronics products, or any other party who distributes, disposes of, or otherwise sells or transfers the product to a third party, to notify such third party in advance of the contents and conditions set forth in this document.
11. This document shall not be reprinted, reproduced or duplicated in any form, in whole or in part, without prior written consent of Renesas Electronics.
12. Please contact a Renesas Electronics sales office if you have any questions regarding the information contained in this document or Renesas Electronics products.
(Note 1) "Renesas Electronics" as used in this document means Renesas Electronics Corporation and also includes its directly or indirectly controlled subsidiaries.
(Note 2) "Renesas Electronics product(s)" means any product developed or manufactured by or for Renesas Electronics.

(Rev.4.0-1 November 2017)



SALES OFFICES

Renesas Electronics Corporation

<http://www.renesas.com>

Refer to "<http://www.renesas.com/>" for the latest and detailed information.

Renesas Electronics America Inc.
1001 Murphy Ranch Road, Milpitas, CA 95035, U.S.A.
Tel: +1-408-432-8888, Fax: +1-408-434-5351

Renesas Electronics Canada Limited
9251 Yonge Street, Suite 8309 Richmond Hill, Ontario Canada L4C 9T3
Tel: +1-905-237-2004

Renesas Electronics Europe Limited
Dukes Meadow, Millboard Road, Bourne End, Buckinghamshire, SL8 5FH, U.K
Tel: +44-1628-651-700, Fax: +44-1628-651-804

Renesas Electronics Europe GmbH
Arcadiastrasse 10, 40472 Düsseldorf, Germany
Tel: +49-211-6503-0, Fax: +49-211-6503-1327

Renesas Electronics (China) Co., Ltd.
Room 1709 Quantum Plaza, No.27 ZhichunLu, Haidian District, Beijing, 100191 P. R. China
Tel: +86-10-8235-1155, Fax: +86-10-8235-7679

Renesas Electronics (Shanghai) Co., Ltd.
Unit 301, Tower A, Central Towers, 555 Langao Road, Putuo District, Shanghai, 200333 P. R. China
Tel: +86-21-2226-0888, Fax: +86-21-2226-0999

Renesas Electronics Hong Kong Limited
Unit 1601-1611, 16/F., Tower 2, Grand Century Place, 193 Prince Edward Road West, Mongkok, Kowloon, Hong Kong
Tel: +852-2265-6688, Fax: +852-2886-9022

Renesas Electronics Taiwan Co., Ltd.
13F, No. 363, Fu Shing North Road, Taipei 10543, Taiwan
Tel: +886-2-8175-9600, Fax: +886-2-8175-9670

Renesas Electronics Singapore Pte. Ltd.
80 Bendemeer Road, Unit #06-02 Hyflux Innovation Centre, Singapore 339949
Tel: +65-6213-0200, Fax: +65-6213-0300

Renesas Electronics Malaysia Sdn.Bhd.
Unit 1207, Block B, Menara Amcorp, Amcorp Trade Centre, No. 18, Jln Persiaran Barat, 46050 Petaling Jaya, Selangor Darul Ehsan, Malaysia
Tel: +60-3-7955-9390, Fax: +60-3-7955-9510

Renesas Electronics India Pvt. Ltd.
No.777C, 100 Feet Road, HAL 2nd Stage, Indiranagar, Bangalore 560 038, India
Tel: +91-80-67208700, Fax: +91-80-67208777

Renesas Electronics Korea Co., Ltd.
17F, KAMCO Yangjae Tower, 262, Gangnam-daero, Gangnam-gu, Seoul, 06265 Korea
Tel: +82-2-558-3737, Fax: +82-2-558-5338