

# Application Note

## Power Solutions for Xilinx Artix-7 and Zynq-7000

AN-PM-106

### Abstract

*This application note provides information on powering the Xilinx Artix-7 and Zynq-7000 family of devices.*

---

---

**Power Solutions for Xilinx Artix-7 and Zynq-7000**

---

**Contents**

<b>Abstract</b> .....	<b>1</b>
<b>Contents</b> .....	<b>2</b>
<b>Figures</b> .....	<b>3</b>
<b>Tables</b> .....	<b>3</b>
<b>1 Terms and Definitions</b> .....	<b>4</b>
<b>2 References</b> .....	<b>4</b>
<b>3 Introduction</b> .....	<b>5</b>
<b>4 The Artix-7</b> .....	<b>6</b>
4.1 The Dialog DA9062.....	7
4.1.1 The DA9062 Regulators .....	8
4.1.2 The DA9062 PCB Footprint .....	8
4.2 DA9063 and DA9063L Devices .....	9
4.2.1 DA9063 Regulators .....	10
4.3 Dialog Sub-PMIC Options .....	11
4.4 Example Artix-7 Power Mapping.....	12
4.4.1 Lower Power Artix-7 Designs .....	12
4.4.2 Medium Power Artix-7 Mapping .....	12
4.4.3 High Power Artix-7 Mapping.....	13
<b>5 The Xilinx Zynq-7000 SoC Family</b> .....	<b>14</b>
<b>6 Working with the DA9062</b> .....	<b>16</b>
6.1 The DA9062 Evaluation Kit.....	16
6.2 DA9062 Bench Measurements .....	18
6.2.1 Power-On Sequence .....	18
6.2.2 Buck Efficiency .....	19
6.2.3 Static Load Regulation.....	20
6.2.4 Buck Transient Load Regulation .....	22
6.2.5 Reference Measurements .....	27
<b>7 Conclusions</b> .....	<b>29</b>
<b>Revision History</b> .....	<b>30</b>

## Power Solutions for Xilinx Artix-7 and Zynq-7000

### Figures

Figure 1: Artix-7 Power Rail Requirements .....	6
Figure 2: DA9062 Block Diagram .....	7
Figure 3: DA9062 Solution Footprint .....	8
Figure 4: DA9063 Block Diagram .....	9
Figure 5: Xilinx Zynq-7000 Power Supply Consolidation .....	14
Figure 6: The DA9062 Evaluation Board .....	16
Figure 7: The DA9062 SmartCanvas GUI .....	17
Figure 8: The SmartCanvas Drag and Drop Sequence Tool .....	17
Figure 9: Possible Artix-7 Power-On Sequence .....	18
Figure 10: Buck1 Efficiency with $V_{OUT} = 0.95\text{ V}$ and $V_{IN} = 5\text{ V}$ and $3.6\text{ V}$ .....	19
Figure 11: Buck2 Efficiency with $V_{OUT} = 1.35\text{ V}$ and $V_{IN} = 5\text{ V}$ and $3.6\text{ V}$ .....	19
Figure 12: Buck3 Efficiency with $V_{OUT} = 1.8\text{ V}$ and $V_{IN} = 5\text{ V}$ and $3.6\text{ V}$ .....	20
Figure 13: Buck1 Static Load Regulation .....	20
Figure 14: Buck2 Static Load Regulation .....	21
Figure 15: Buck3 Static Load Regulation .....	21
Figure 16: LDO2 Static Load Regulation .....	22
Figure 17: Buck1 Transient Response, 680 mA Step .....	23
Figure 18: Buck1 Transient Response, 1 A Step .....	23
Figure 19: Buck2 Transient Response, $V_{OUT} = 1.35\text{ V}$ , 1 A Step .....	24
Figure 20: Buck2 Transient Response, $V_{OUT} = 1.5\text{ V}$ , 1 A Step .....	24
Figure 21: Buck3 Transient Response, $V_{OUT} = 2.5\text{ V}$ , 1 A Step .....	25
Figure 22: Buck3 Transient Response, $V_{OUT} = 2.5\text{ V}$ , 1.25 A Step .....	25
Figure 23: Buck3 Transient Response, $V_{OUT} = 3.3\text{ V}$ , 1 A Step .....	26
Figure 24: Buck3 Transient Response, $V_{OUT} = 3.3\text{ V}$ , 1.25 A Step .....	26
Figure 25: $V_{REF}$ Over Temperature .....	27
Figure 26: $I_{REF}$ Over Temperature .....	27
Figure 27: VDDCORE Over Temperature .....	28

### Tables

Table 1: Artix-7 Power Rail Requirements .....	6
Table 2: DA9062 Regulator Summary .....	8
Table 3: DA9063 Regulator Summary .....	10
Table 4: Dialog Sub-PMIC Options .....	11
Table 5: DA9062 Mapping .....	12
Table 6: DA9063L Mapping .....	12
Table 7: DA9063L + DA9211 Mapping .....	13
Table 8: Zynq-7000 Additional Rail Requirements .....	14
Table 9: Zynq 7000 Consolidated Supply Rails .....	15
Table 10 Example Z-7020 Mapping .....	15
Table 11: VCCINT Transient Load Results .....	23
Table 12: Buck2 Transient Load Results .....	24
Table 13: Buck3 Transient Load Results .....	25

---

**Power Solutions for Xilinx Artix-7 and Zynq-7000****1 Terms and Definitions**

GUI	Graphical User Interface
PMIC	Power Management Integrated Circuit
DA906x	Dialog DA9061, DA9062, DA9063, and DA9063L
DVC	Dynamic Voltage Control
DVS	Dynamic Voltage Scaling, Analogous to DVC
MPSoC	Multiprocessor System-on-Chip
OTP	One-Time Programmable (Memory)
RTC	Real-Time Clock
SoC	System-on-Chip
PL	Programmable Logic
PS	Processor System

**2 References**

- [1] Xilinx Power Estimator (XPE), <http://www.xilinx.com/products/technology/power/xpe.html> (Accessed 21-May-2018)
- [2] Philofsky, B., Seven Steps to an Accurate Worst-Case Power Analysis Using Xilinx Power Estimator (XPE), WP353, v1.0, Xilinx Inc., 2008.
- [3] DA9061, Datasheet, Dialog Semiconductor, [Dialog Website Link](#)
- [4] DA9062, Datasheet, Dialog Semiconductor, [Dialog Website Link](#)
- [5] DA9063, Datasheet, Dialog Semiconductor, [Dialog Website Link](#)
- [6] DA9063L, Datasheet, Dialog Semiconductor, [Dialog Website Link](#)
- [7] AN-PM-080, In-Circuit Programming of DA9061/2/3, Dialog Semiconductor, 2016, [Dialog Website Link](#)
- [8] UM-PM-008, SmartCanvas™ DA9061/2 User Manual, Dialog Semiconductor, [Dialog Website Link](#)
- [9] UG583, [UltraScale Architecture PCB Design User Guide \(ver1.10\)](#)
- [10] Artix-7 FPGAs Data Sheet: DC and AC Switching Characteristics, Xilinx, [Link](#)
- [11] DA9062 Performance Board Schematic, Dialog Semiconductor, [Dialog Website Link](#)

### 3 Introduction

The Xilinx Artix-7 family of FPGA devices provide the highest performance-per-watt fabric, transceiver line rates, DSP processing, and AMS integration in a cost-optimized FPGA. The Xilinx Zynq-7000 family of devices further extend this flexibility to include an Arm based processor sub-system alongside the programmable logic. To fully realize the performance of a Artix -7 or Zynq-7000 device requires an optimized power management solution. Dialog offers a range of power management solutions that will provide flexibility to match the requirements of most FPGA designs while maximizing performance and integration, and minimizing the PCB footprint.

Power Solutions for Xilinx Artix-7 and Zynq-7000

4 The Artix-7

The following sections introduce the basic power rail requirements of the Artix-7 devices along with the capabilities of the Dialog DA9062 and DA9063L PMICs, and show why they can be the perfect partner to an Artix-7.

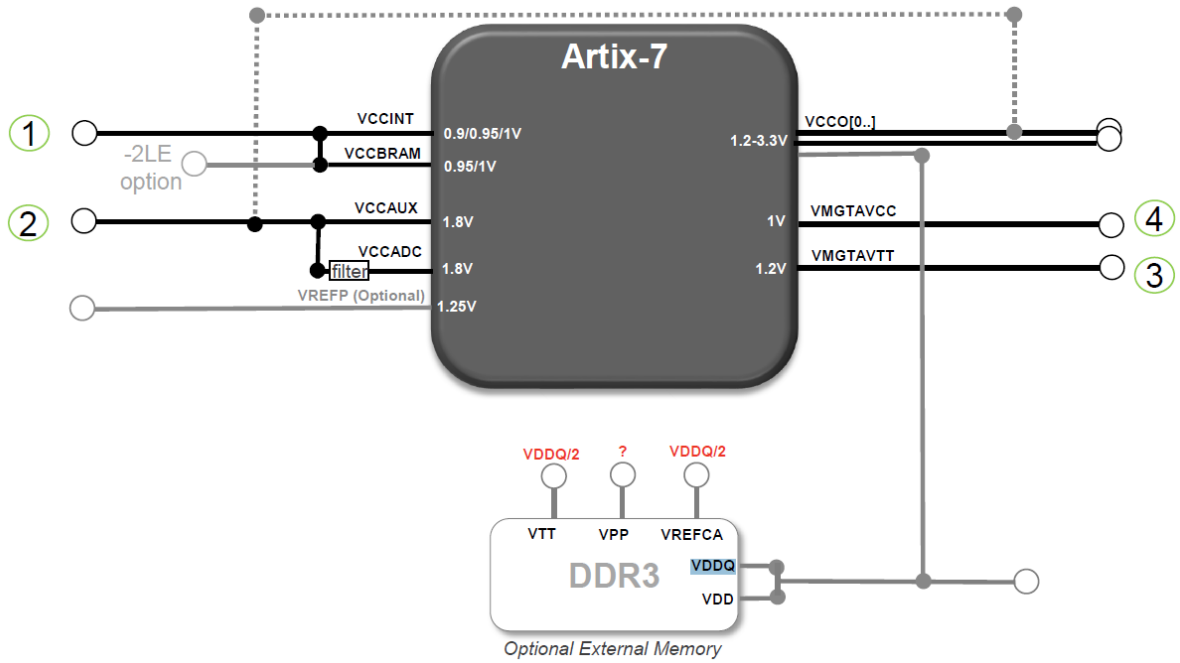

Figure 1: Artix-7 Power Rail Requirements

Table 1: Artix-7 Power Rail Requirements

Rail	Voltage	Load (A)
VCCINT	0.95 or 1 V $\pm 5$ %, 0.9 V $\pm 3$ % (-2LE)	0.3 to 6
VCCBRAM	0.95 or 1 V $\pm 5$ %	0.1
VCCAUX and VCCADC	1.8 V $\pm 5$ %	0.15 to 0.35
VMGTAVCC	1.2 V $\pm 3$ %	0.15 to 1
VMGTAVTT	1 V $\pm 2.5$ %	0.05 to 0.4
VCC_IO	1.8 or 2.5 or 3.3 V $\pm 5$ %	0.2 to 2.5
VCC_DDR	1.5 or 1.35 V $\pm 5$ %	2
DDR_VTT	VCC_DDR/2	
DDR_VREF		

Power Solutions for Xilinx Artix-7 and Zynq-7000

4.1 The Dialog DA9062

DA9062 flexible power management IC integrates four bucks and four LDOs capable of supplying individual rails of up to 2.5 A. This device ideally matches the requirements of the smaller members of the Artix-7 family of devices.

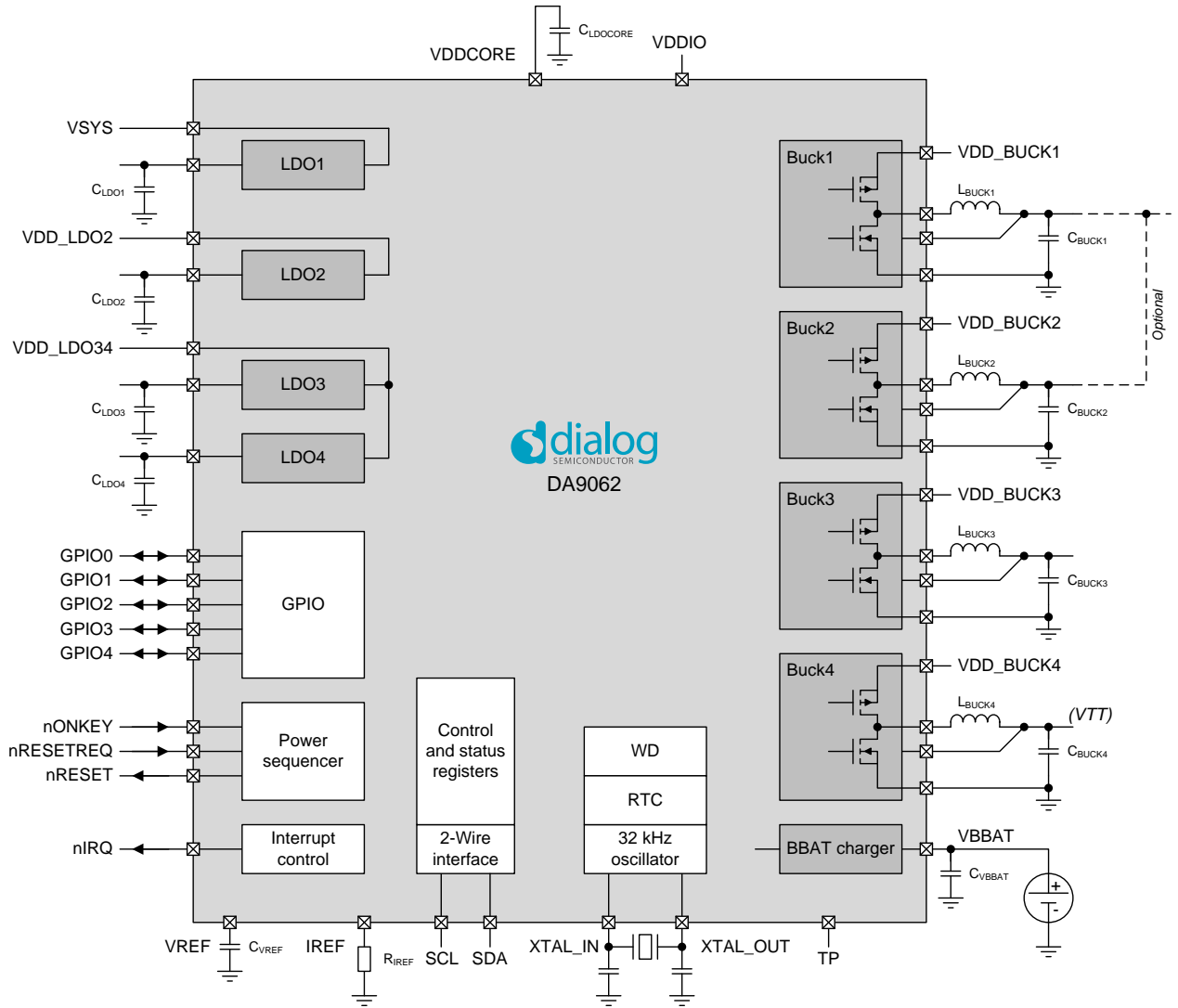

Figure 2: DA9062 Block Diagram

## Power Solutions for Xilinx Artix-7 and Zynq-7000

### 4.1.1 The DA9062 Regulators

Table 2: DA9062 Regulator Summary

Regulator	Supplied Voltage (V)	Supplied Max. Current (A)	External Component	Notes
Buck1	0.3 to 1.57	2.5	1.0 $\mu$ H/2 x 47 $\mu$ F	3 MHz, DVS with variable slew rate, 10 mV steps
Buck2	0.3 to 1.57	2.5	1.0 $\mu$ H/2 x 47 $\mu$ F	3 MHz, DVS with variable slew rate, 10 mV steps, can be combined with Buck1 as a 5 A dual-phase buck
Buck3	0.8 to 3.34	2.0	1.0 $\mu$ H/2 x 22 $\mu$ F or 2 x 47 $\mu$ F	3 MHz, DVS with variable slew rate, 20 mV steps
Buck4	0.53 to 1.8	1.5	1.0 $\mu$ H/2 x 22 $\mu$ F or 2 x 47 $\mu$ F	3 MHz, DVS with variable slew rate, 10 mV steps, can be used as a DDR VTT supply
LDO1	0.9 to 3.6	0.1	1.0 $\mu$ F	Programmable in 50 mV steps, can be configured as an Always-on supply
LDO2	0.9 to 3.6	0.3	2.2 $\mu$ F	Programmable in 50 mV steps
LDO3	0.9 to 3.6	0.3	2.2 $\mu$ F	Programmable in 50 mV steps
LDO4	0.9 to 3.6	0.3	2.2 $\mu$ F	Programmable in 50 mV steps

### 4.1.2 The DA9062 PCB Footprint

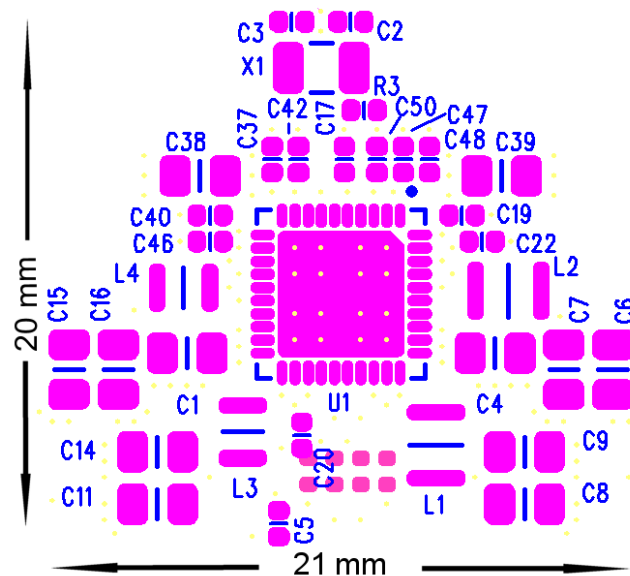

Figure 3: DA9062 Solution Footprint

The high level of integration along with the 3 MHz switching frequency results in a compact footprint. Figure 3 is an example footprint including all of the required passive components. The total area is less than 420 mm<sup>2</sup>. This is achieved with all of the components on the top side of the PCB and without the use of over-aggressive placement. This area could be further reduced by placing some of the capacitors on the reverse of the PCB and by more aggressive spacing rules. As shown, there is significant unused space in the calculated area, possibly up to 25 %, see the DA9062 Performance board data pack for more details [11].



Power Solutions for Xilinx Artix-7 and Zynq-7000

4.2 DA9063 and DA9063L Devices

DA9063 flexible PMIC integrates 6 bucks and 11 LDOs capable of supplying individual rails of up to 2.5 A. The DA9063 also includes an RTC. This device ideally matches many of the requirements the of the larger members of the Artix-7 family of devices.

The DA9063L is the lite version of the DA9063 which has a slightly reduce feature set. The DA9063L integrates 6 bucks and 5 LDOs.

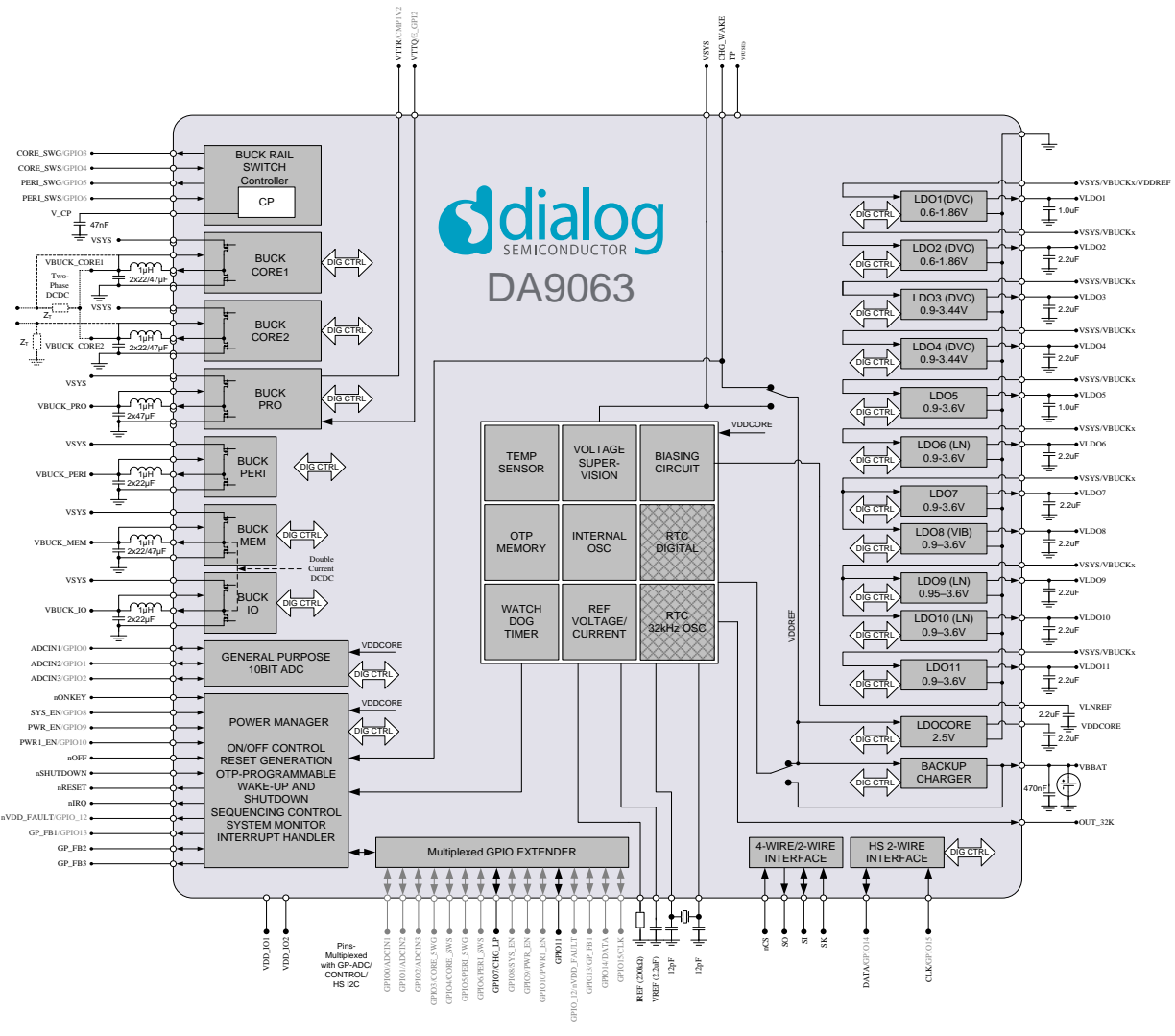

Figure 4: DA9063 Block Diagram

## Power Solutions for Xilinx Artix-7 and Zynq-7000

### 4.2.1 DA9063 Regulators

**Table 3: DA9063 Regulator Summary**

Regulator	Supplied Pins	Supplied Voltage (V)	Supplied Max Current (mA)	External Component	Notes
BUCKCORE1	VBUCKCORE1	0.3 to 1.57	1250/2500 (full-current mode)	1.0 $\mu$ H/ 44 $\mu$ F/ 88 $\mu$ F	DVC 10 mV steps < 0.7 V PFM mode only 5 A dual-phase buck when combined with BUCKCORE2
BUCKCORE2	VBUCKCORE2	0.3 to 1.57	1250/2500 (full-current mode)	1.0 $\mu$ H/ 44 $\mu$ F/ 88 $\mu$ F	DVC 10 mV steps < 0.7 V PFM mode only 5 A dual-phase buck when combined with BUCKCORE1
BUCKPRO	VBUCKPRO	0.53 to 1.80	1250/2500 (full-current mode)	1.0 $\mu$ H/ 44 $\mu$ F/ 88 $\mu$ F	DVC 10 mV steps and VTT regulator mode < 0.7 V PFM mode only
BUCKMEM	VBUCKMEM	0.8 to 3.34	1500	1.0 $\mu$ H/ 44 $\mu$ F	DVC 20 mV steps 3 A (merge mode with BUCKIO)
BUCKIO	VBUCKIO	0.8 to 3.34	1500	1.0 $\mu$ H/ 44 $\mu$ F	DVC 20 mV steps 3 A (merge mode with BUCKMEM)
BUCKPERI	VBUCKPERI	0.8 to 3.34	1500	1.0 $\mu$ H/ 44 $\mu$ F	DVC 20 mV steps
LDO1	VLDO1	0.6 to 1.86	100	1.0 $\mu$ F	DVC 20 mV steps Optional voltage tracking of BUCKCORE or BUCKPRO
LDO2	VLDO2	0.6 to 1.86	200	2.2 $\mu$ F	DVC 20 mV steps
LDO3	VLDO3	0.9 to 3.44	200	2.2 $\mu$ F	Bypass mode DVC 20 mV steps
LDO4	VLDO4	0.9 to 3.44	200	2.2 $\mu$ F	Bypass mode DVC 20 mV steps
LDO5	VLDO5	0.9 to 3.6	100	1.0 $\mu$ F	50 mV steps
LDO6	VLDO6	0.9 to 3.6	200	2.2 $\mu$ F	50 mV steps, Low noise
LDO7	VLDO7	0.9 to 3.6	200	2.2 $\mu$ F	Bypass mode 50 mV steps Common supply with LDO8
LDO8	VLDO8	0.9 to 3.6	200	2.2 $\mu$ F	Bypass and switching

## Power Solutions for Xilinx Artix-7 and Zynq-7000

Regulator	Supplied Pins	Supplied Voltage (V)	Supplied Max Current (mA)	External Component	Notes
					vibration motor driver mode 50 mV steps Common supply with LDO7
LDO9	VLDO9	0.95 to 3.6	200	2.2 $\mu$ F	Low noise 50 mV steps OTP trimmed Common supply with LDO10
LDO10	VLDO10	0.9 to 3.6	300	2.2 $\mu$ F	Low noise LDO 50 mV steps Common supply with LDO9
LDO11	VLDO11	0.9 to 3.6	300	2.2 $\mu$ F	Bypass mode 50 mV steps
BACKUP	VBBAT	1.1 to 3.1	6	470 nF	100 mV/200 mV steps Configurable charge current between 100 $\mu$ A and 6000 $\mu$ A Reverse current protection (RCP)
LDOCORE	Internal PMIC supply	2.5 $\pm$ 2 % accuracy	4	2.2 $\mu$ F	Internal LDO

### 4.3 Dialog Sub-PMIC Options

For individual high current rails that cannot be met by the integrated regulators of one of the system PMICs, Dialog has the DA921x family of Sub-PMICs. These can be enabled from the sequencer in the system PMIC see [Table 4](#) for the currently available devices.

**Table 4: Dialog Sub-PMIC Options**

Device	Current (A)	Phase
DA9210	12	4
DA9211	12	4
DA9212	6 + 6	2, 2
DA9213	20	4
DA9214	15 + 5	3, 1
DA9215	10 + 10	2, 2

## Power Solutions for Xilinx Artix-7 and Zynq-7000

### 4.4 Example Artix-7 Power Mapping

Comparing the Artix-7 power rail requirements from [Table 1](#) with the DA9062 available regulators in [Table 2](#), it is clear that the DA9062 is a good match for designs using the smaller members of the Artix-7 family. For the larger devices requiring VCCINT up to 5.5 A we can use a DA9063L. For the largest devices and for designs where extra margin is required we can pair up either a DA9063L or a DA9062 along with a Dialog sub-PMIC such as the DA9212 to meet the higher current requirements.

Sections [4.4.1](#), [4.4.2](#) and [4.4.3](#) provide example mapping for each of the above three scenarios.

#### 4.4.1 Lower Power Artix-7 Designs

See [Table 5](#) for mapping the Artix-7 on to the DA9062 rails.

**Table 5: DA9062 Mapping**

	Artix-7			DA9062	
		Voltage	Load (A)	Rail	Max (A)
1	VCCINT	0.9/0.95/1	0.3 to 6	Buck1	2.5
2	VCCBRAM	0.95/1	0.1	LDO1	0.1
3	VCCAUX	1.8	0.15 to 0.35	LDO2	0.3
3	VCCADC	1.8			
	VREFP	1.25			
4	VCCIO	1.2-3.3	0.2 to 2.5	Buck3	2
5	VMGTAVCC	1	0.15 to 1	LDO3	0.3
6	VMGTAVTT	1.2	0.05 to 0.4	LDO4	0.3
7	VDDQ	1.35 or 1.5	2	Buck2	2.5
8	VREFCA		0.01	VTTREF	0.01
9	VTT		1	Buck4	

#### 4.4.2 Medium Power Artix-7 Mapping

**Table 6: DA9063L Mapping**

	Artix-7			DA9063L	
		Voltage	Load(A)	Rail	Max.(A)
1	VCCINT	0.9/0.95/1	0.3 to 6	VCORE1 and 2	5+
2	VCCBRAM	0.95/1	0.1	LDO9	0.1
3	VCCAUX	1.8	0.15 to 0.35	LDO11	0.3
3	VCCADC	1.8			
	VREFP	1.25			
4	VCCIO	1.2 - 3.3	0.2 to 2.5	PERI	1.5
5	VMGTAVCC	1	0.15 to 1	IO	1.5
6	VMGTAVTT	1.2	0.05 to 0.4	LDO7 and 8	0.4
7	VDDQ	1.35 or 1.5	2	MEM	1.5
8	VREFCA		0.01	VTTREF	0.01
9	VTT		1	VPRO	

## Power Solutions for Xilinx Artix-7 and Zynq-7000

### 4.4.3 High Power Artix-7 Mapping

**Table 7: DA9063L + DA9211 Mapping**

	Artix-7			DA9063L and DA9211	
		Voltage	Load (A)	Rail	Max (A)
1	VCCINT	0.9/0.95/1	0.3 to 6	DA9211	12
2	VCCBRAM	0.95/1	0.1	LDO7	0.1
3	VCCAUX	1.8	0.15 to 0.35	LDO11	0.3
3	VCCADC	1.8			
	VREFP	1.25			
4	VCCIO	1.2 to 3.3	0.2 to 2.5	MEM and IO	3
5	VMGTAVCC	1	0.15 to 1	PERI	1.5
6	VMGTAVTT	1.2	0.05 to 0.4	VCORE1	1.5
7	VDDQ	1.35 or 1.5	2	VCORE2	2.5
8	VREFCA		0.01	VTTREF	0.01
9	VTT		1	VPRO	

## Power Solutions for Xilinx Artix-7 and Zynq-7000

### 5 The Xilinx Zynq-7000 SoC Family

The Zynq-7000 family combines the power of an FPGA with the programmability of an ARM Cortex™-A9 processor.

The Smaller devices in the Zynq-7000 family, up to the Z-7020, integrate the equivalent of an Artix-7 device alongside either a single or dual core ARM processor system. As a result, the power requirements are similar between the Artix-7 and the Z-7000. It is recommended that designers refer to the Xilinx XPE,[1] to estimate the actual current requirements for any given design.

The Zynq-7000 design will have very similar current requirements to the similar sized Artix-7 device, with the addition of the current required for the processor system.

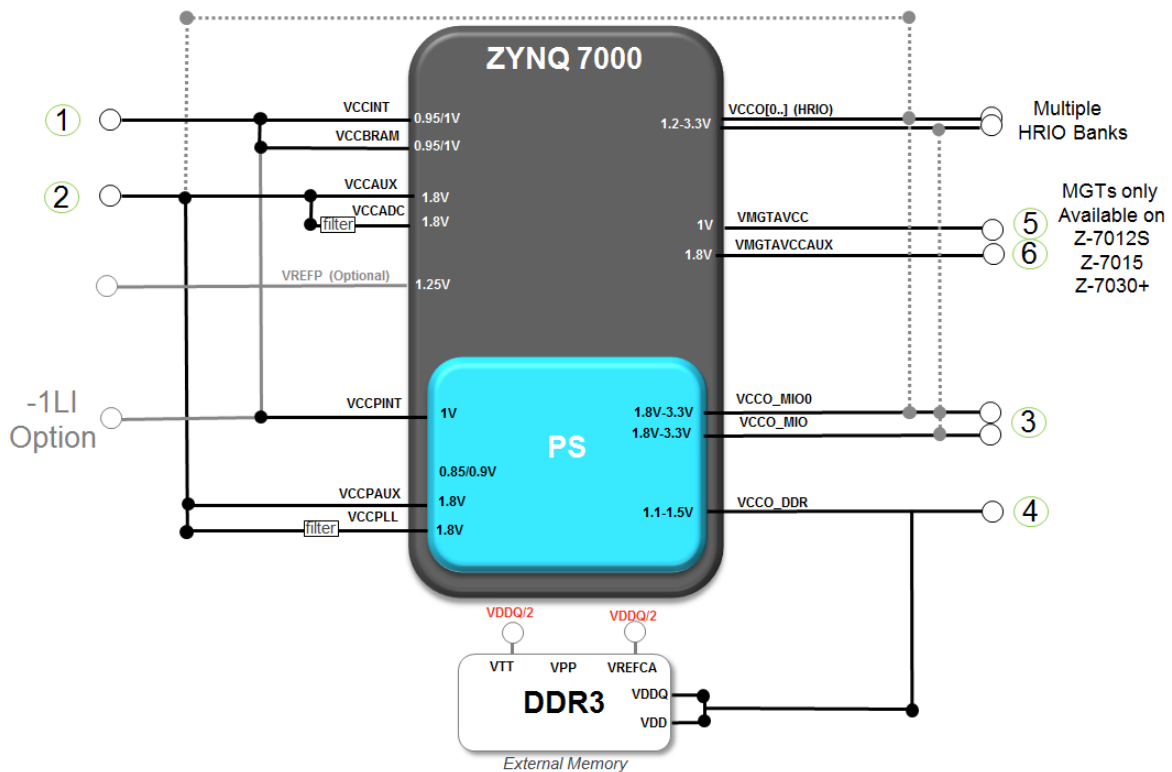

**Figure 5: Xilinx Zynq-7000 Power Supply Consolidation**

As shown in [Figure 5](#), the addition of the processor sub-system requires four additional rails, VCCPINT, VCCPAUX and VCCPLL, VCCO\_MIO, and VCCO\_DDR in addition to the rails used by the programmable logic in the Artix-7 device. These rails can be consolidated with existing rails, see [Table 8](#) for example requirements for these additional rails.

**Table 8: Zynq-7000 Additional Rail Requirements**

Rail	Voltage	Load
VCCPINT (Single Core)	1 V $\pm$ 5 %	0.7 A
VCCPINT (Dual Core)		1 A
VCCPAUX and VCCPLL	1.8 V $\pm$ 5 %	0.1 A
VCCO_MIO	1.8/2.5/3.3 V $\pm$ 5 %	USER
VCCO_DDR	1.5/1.35 V $\pm$ 5 %	USER

## Power Solutions for Xilinx Artix-7 and Zynq-7000

Table 9 provides a list of the supply rails for a Zynq-7000 device including those required for the PS and PL domains.

**Table 9: Zynq 7000 Consolidated Supply Rails**

	Rail	Voltage
	VIN	12 V
1	VCCINT	0.95/1 V $\pm 5\%$ , 0.9 V $\pm 3\%$ (-2LE)
	VCCBRAM	
	VCCPINT	1 V $\pm 5\%$
2	VCCAUX	1.8 V $\pm 5\%$
	VCCADC	
	VCCPAUX	
	VCCPLL	
3	VCCO_MIO0	1.8/2.5/3.3 V $\pm 5\%$
	VCCO_MIO	
	VCCO	
4	VCCO_DDR	1.5/1.35 V $\pm 5\%$
5	VMGTAVCC	
6	VMGTAVCCAUX	
7	DDR_VTT	VCCO_DDR/2
8	DDR_VREF	VCCO_DDR/2

Table 10 provides an example Mapping for a Xilinx Zynq Z-7020. In the example the Zynq-7020 is mapped on to DA9062, which is able to supply all of the core rails and has two spare LDO that can be utilized elsewhere in the design.

**Table 10 Example Z-7020 Mapping**

	Rail	Voltage	Load	Comment	DA9062	
1	VCCPINT, VCCINT, VCCBRAM	1 V $\pm 5\%$	2 A		Buck1	2.5 A
2	VCCPAUX, VCCPLL, VCCAUX, VCCADC	1 V $\pm 5\%$	0.5 A		LDO2 and 3	0.3 A x2
4	VCCO_DDR	1.5/1.35 V $\pm 5\%$	2 A	DDR3 or DDR3L	Buck2	2.5 A
7	DDR_VTT	VCC_DDR/2		USER defined	Buck4	1.5 A
8	DDR_VREF	VCC_DDR/2			GPIO1	0.01 A
3	VCCO_MIO, VCCO	1.8/2.5/3.3 V $\pm 5\%$	1.5 A		Buck3	2 A

## Power Solutions for Xilinx Artix-7 and Zynq-7000

## 6 Working with the DA9062

## 6.1 The DA9062 Evaluation Kit

The DA9062 Evaluation kit includes a flexible evaluation board to allow access to all of the key features of the part. The evaluation kit also includes the Dialog SmartCanvas™ GUI which simplifies the control and configuration of the DA9062.

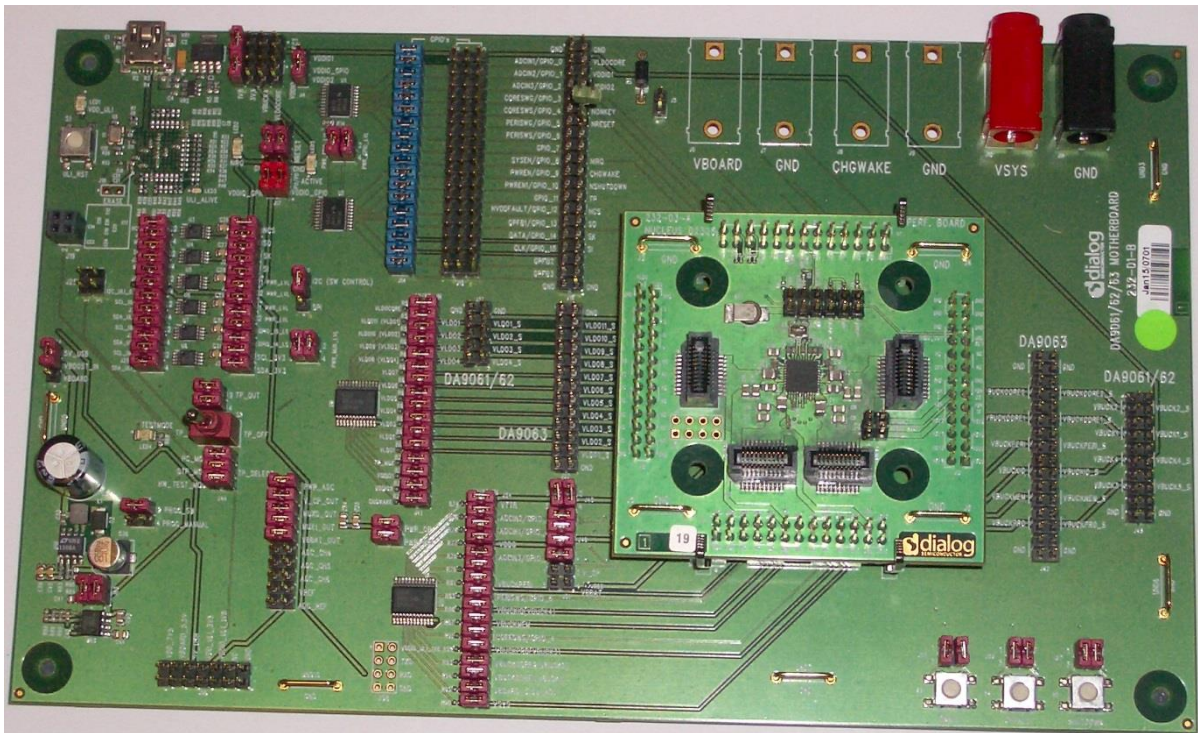

Figure 6: The DA9062 Evaluation Board



Power Solutions for Xilinx Artix-7 and Zynq-7000

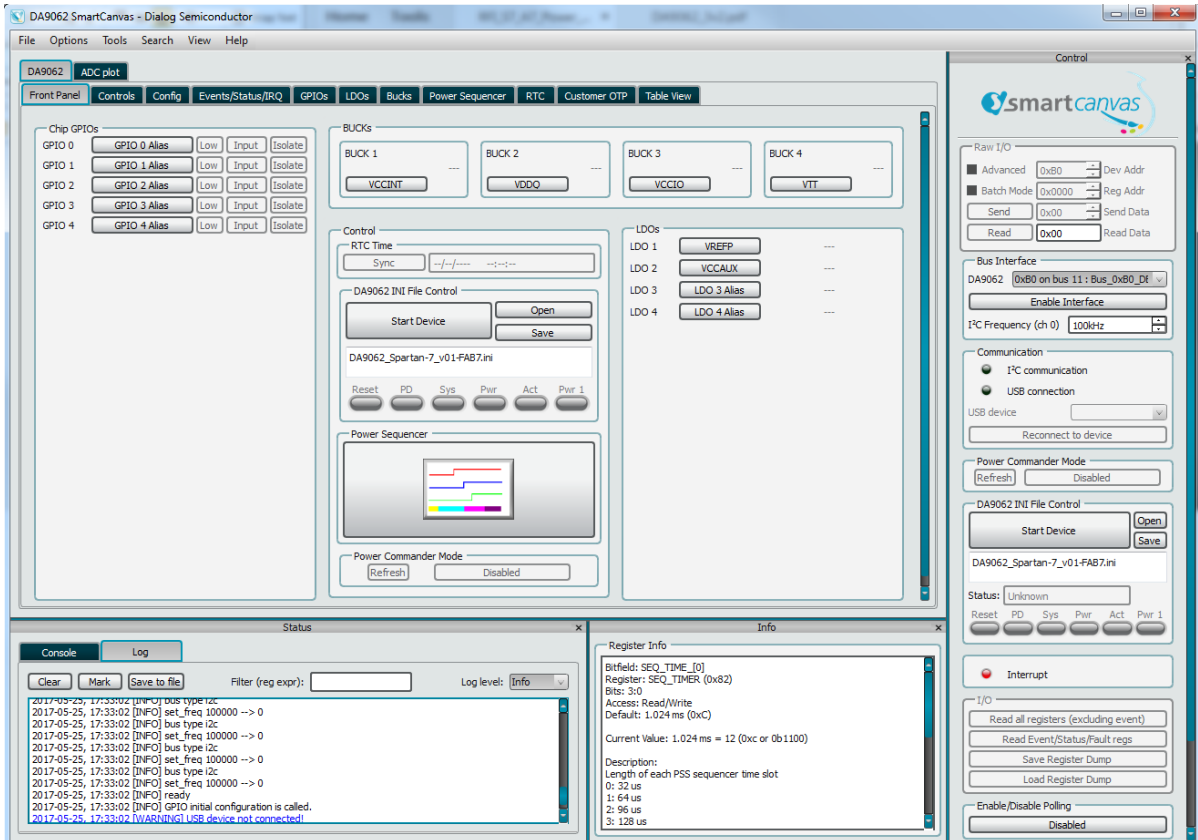

Figure 7: The DA9062 SmartCanvas GUI

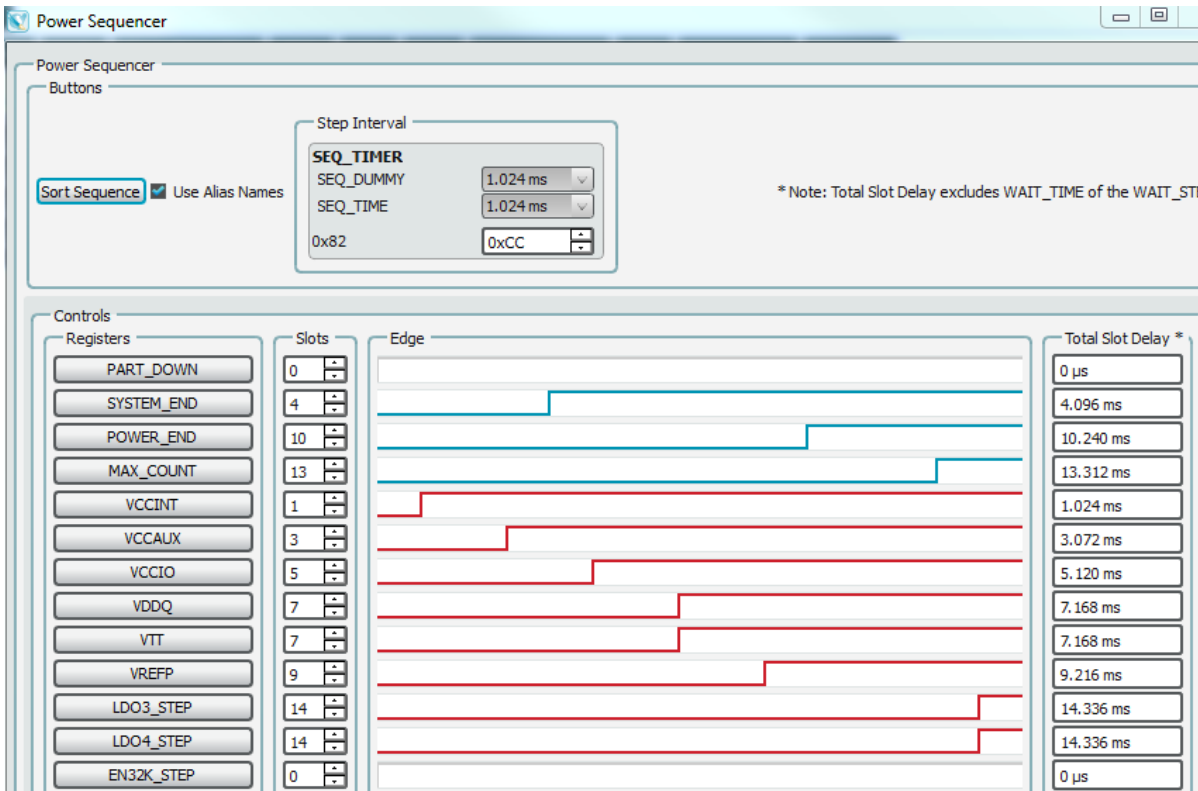

Figure 8: The SmartCanvas Drag and Drop Sequence Tool

## Power Solutions for Xilinx Artix-7 and Zynq-7000

### 6.2 DA9062 Bench Measurements

This section provides some basic performance measurements made using the DA9062 Evaluation kit.

The following measurements are included:

- power-on sequence
- buck efficiency
- static load regulation.
- buck transient load regulation
- reference measurements

#### 6.2.1 Power-On Sequence

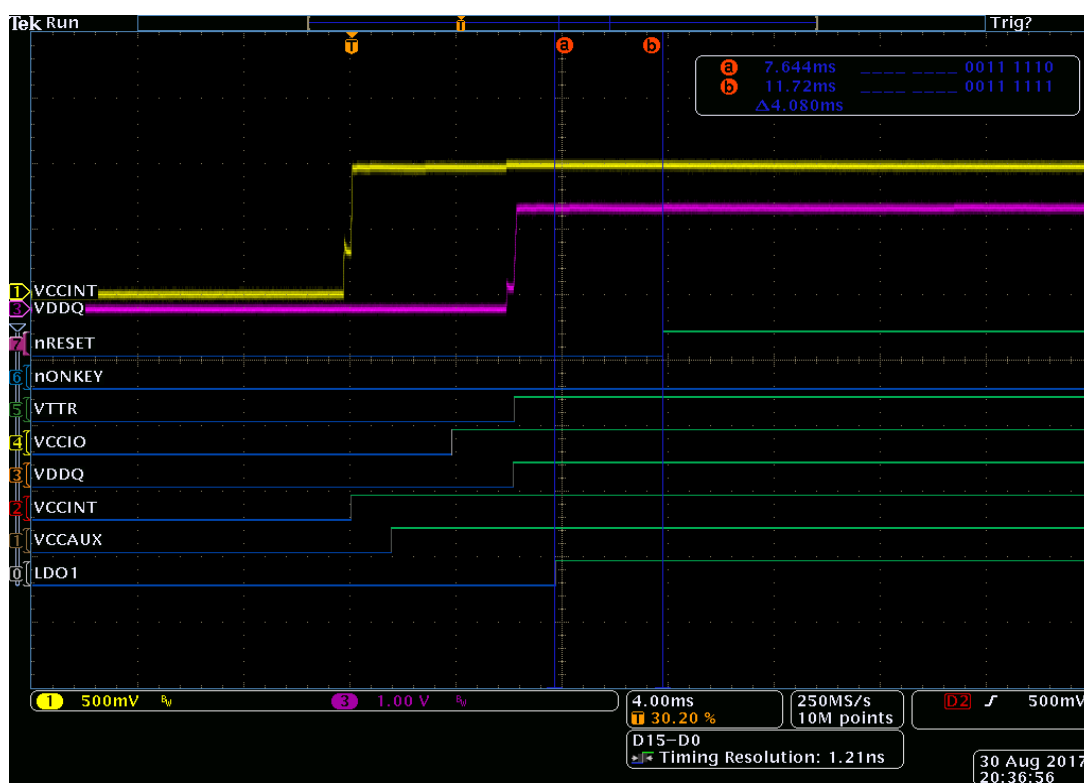

Figure 9: Possible Artix-7 Power-On Sequence

6.2.2 Buck Efficiency

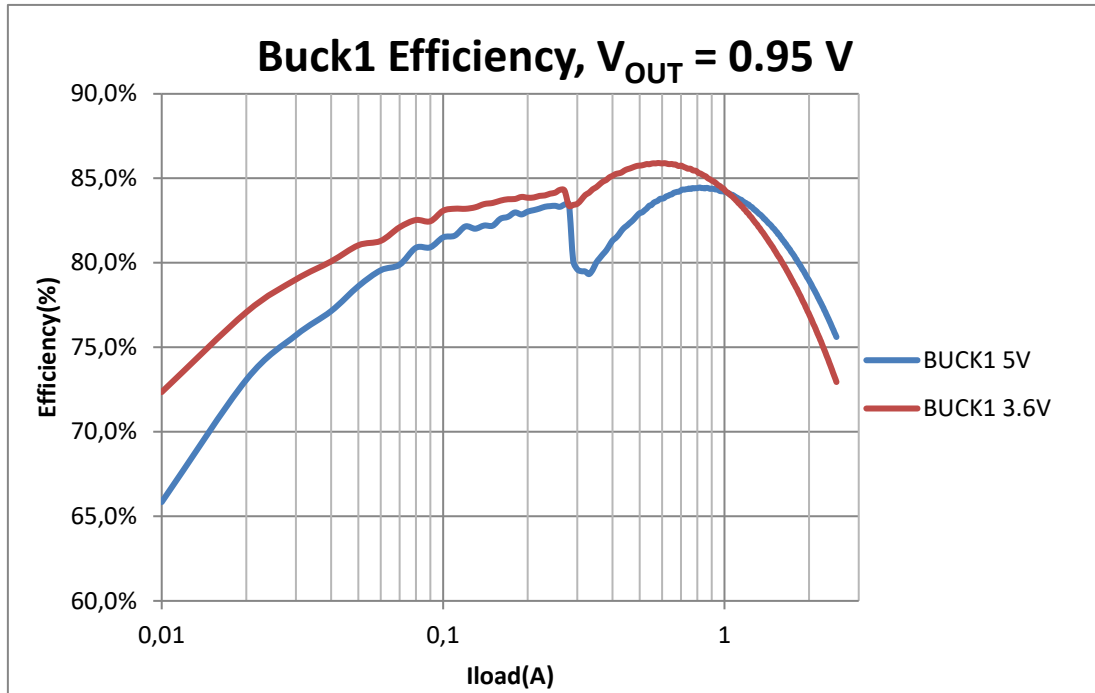

Figure 10: Buck1 Efficiency with V<sub>OUT</sub> = 0.95 V and V<sub>IN</sub> = 5 V and 3.6 V

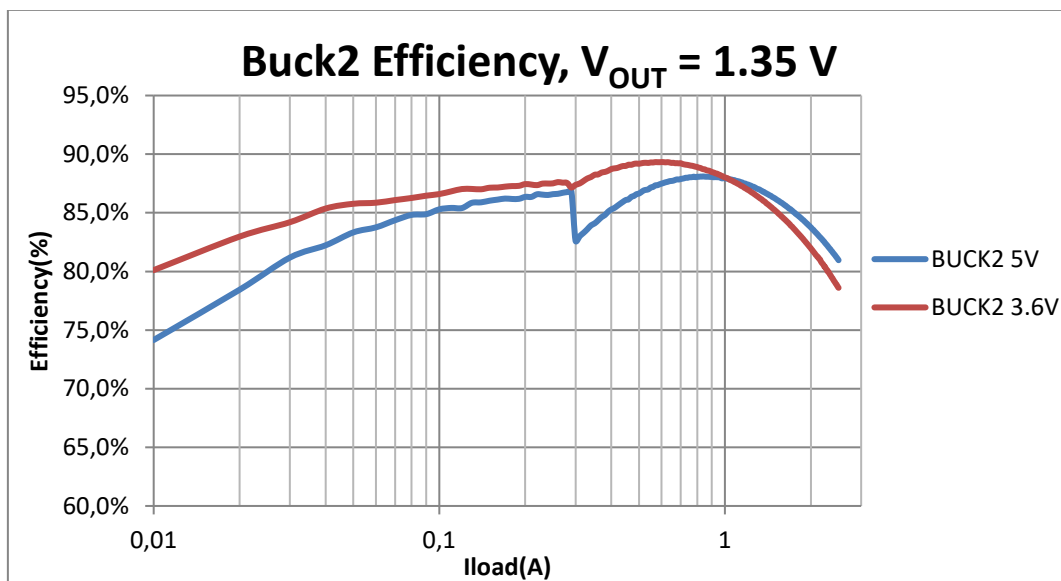

Figure 11: Buck2 Efficiency with V<sub>OUT</sub> = 1.35 V and V<sub>IN</sub> = 5 V and 3.6 V

Power Solutions for Xilinx Artix-7 and Zynq-7000

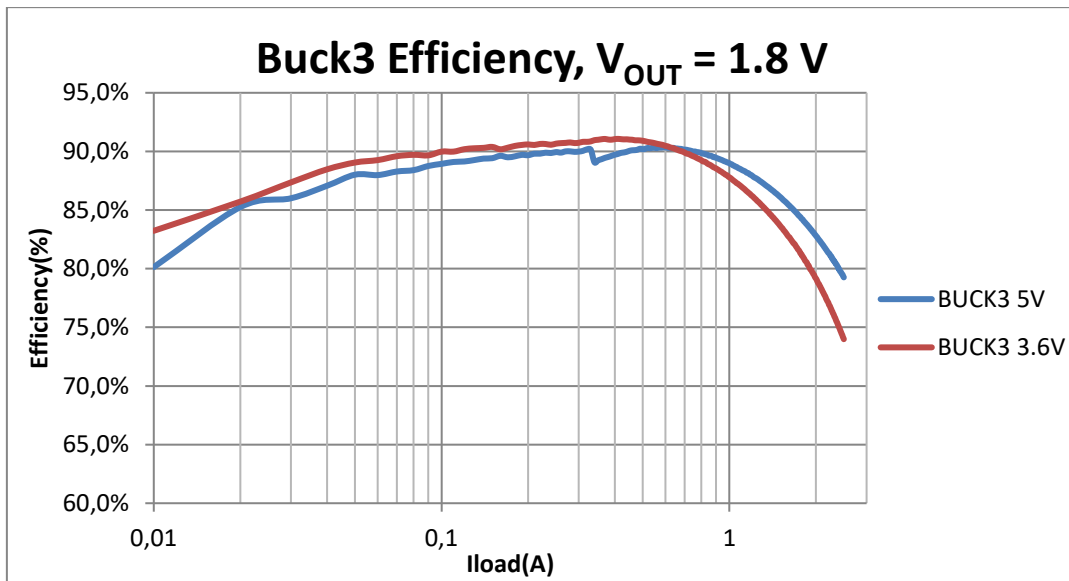

Figure 12: Buck3 Efficiency with  $V_{OUT} = 1.8 V$  and  $V_{IN} = 5 V$  and  $3.6 V$

6.2.3 Static Load Regulation

The following static load regulation plots show the variation on the output voltage over a sweep of the load. The buck regulators were running in Auto mode. The change in slope at approximately 300 mA is where the buck transitions from PFM to PWM.

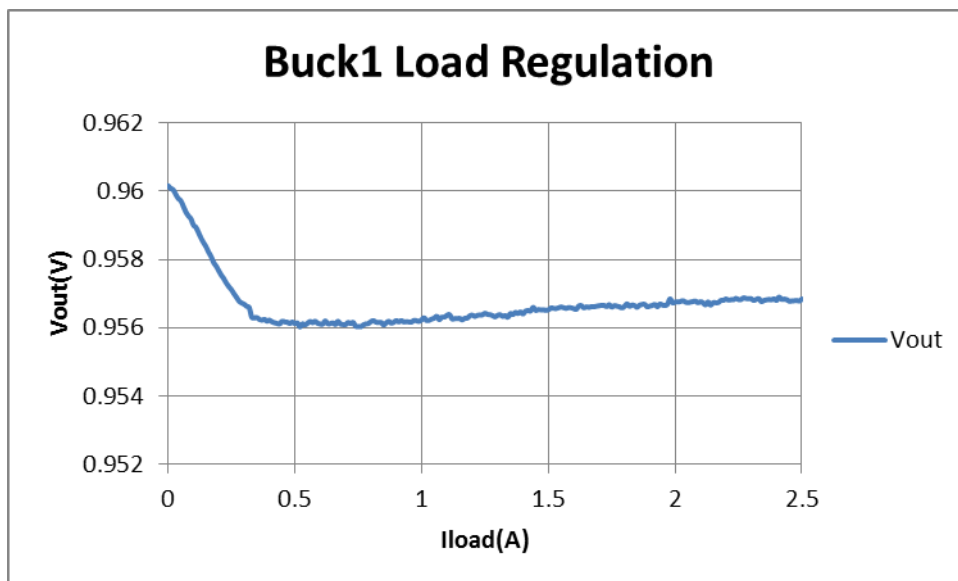

Figure 13: Buck1 Static Load Regulation

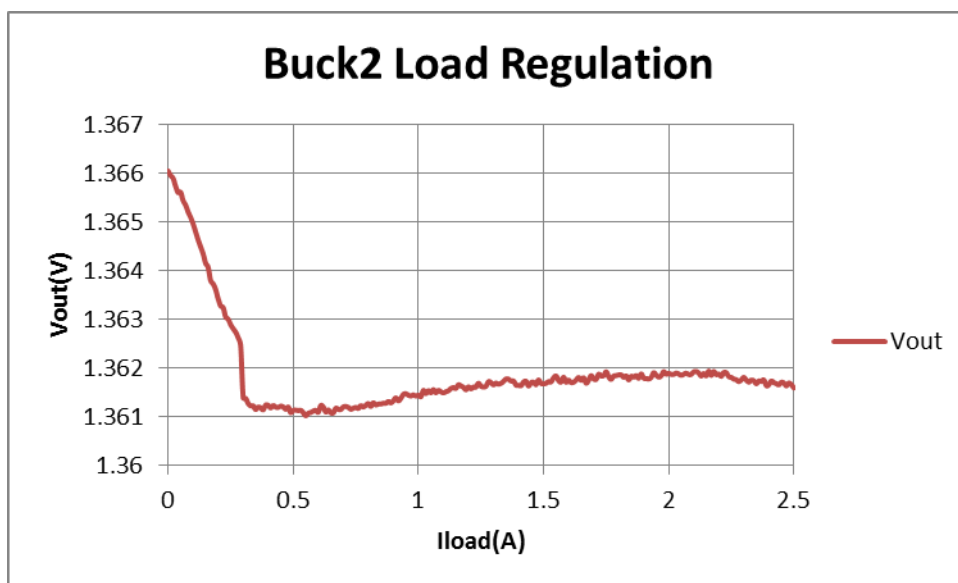

Figure 14: Buck2 Static Load Regulation

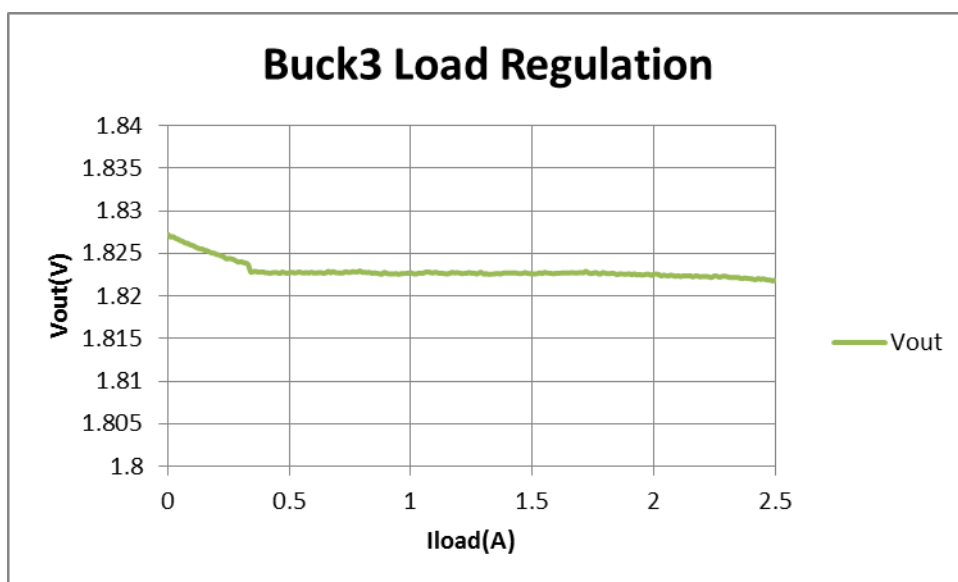

Figure 15: Buck3 Static Load Regulation

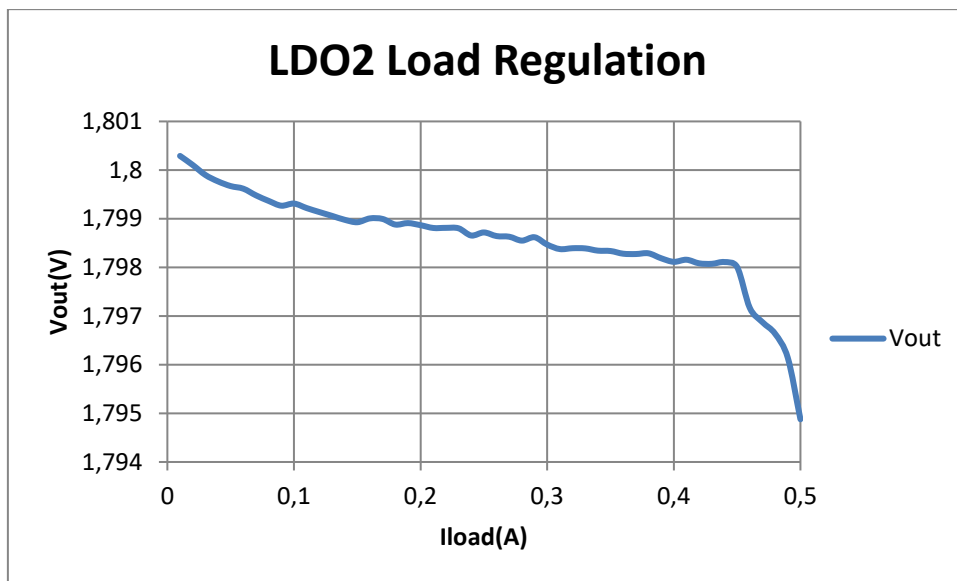

Figure 16: LDO2 Static Load Regulation

#### 6.2.4 Buck Transient Load Regulation

For the transient measurements in this section, the oscilloscope is configured as follows:

- Channel1 (Yellow) shows the regulator output.  
The output was AC coupled, the buck was set to 0.95 V. The Min and Max measurements show the maximum excursion during the transient event.
- Channel 2 (Blue) shows the transient load being applied.  
The Low and High measurements were configured to show the levels of the current pulse waveform. The pulse duration was set to 10  $\mu$ s.
- Channel 3 (Magenta), where shown, displays the DC coupled output voltage.
- The a and b horizontal cursors show the Xilinx specification limits for the specific voltage rail.

In [Table 11](#), [Table 12](#), and [Table 13](#), the results are given for the transient as a percentage of the maximum load for the regulator. For example, 625 mA is 25 % of 2.5 A. The  $\pm 3$  % specification is then calculated in mV for comparison against the measured result.

Power Solutions for Xilinx Artix-7 and Zynq-7000

Table 11: VCCINT Transient Load Results

VCCINT (V)	Transient Load			Specification Limit (mV)		Measured (mV)	
	Low (mA)	High (mA)	%	-3 %	3 %	Min	Max
0.95	310	990	25 %	-28.5	28.5	-14	13.2
0.95	310	1310	40 %	-28.5	28.5	-20.8	18.4

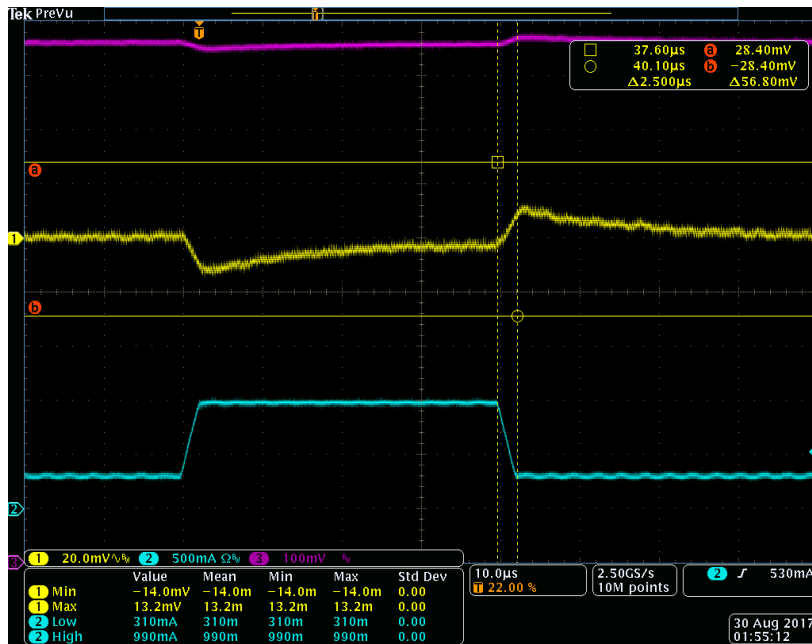

Figure 17: Buck1 Transient Response, 680 mA Step

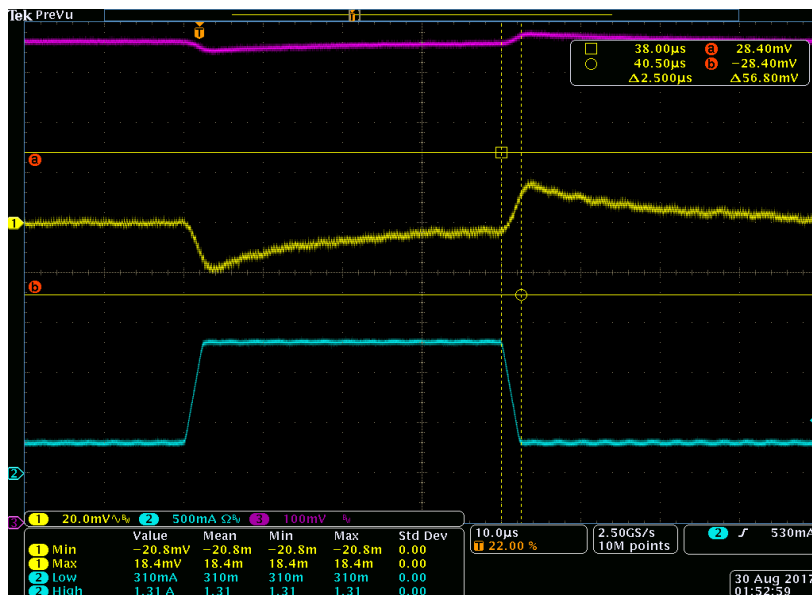

Figure 18: Buck1 Transient Response, 1 A Step

Power Solutions for Xilinx Artix-7 and Zynq-7000

Table 12: Buck2 Transient Load Results

Buck2	Transient Load			Specification Limit (mV)		Measured (mV)	
	Low (mA)	High (mA)	%	-3 %	3 %	Min	Max
1.35	310	1310	40 %	-40.5	40.5	21.2	20.4
1.5	310	1310	40 %	-45	45	-20.4	21.2

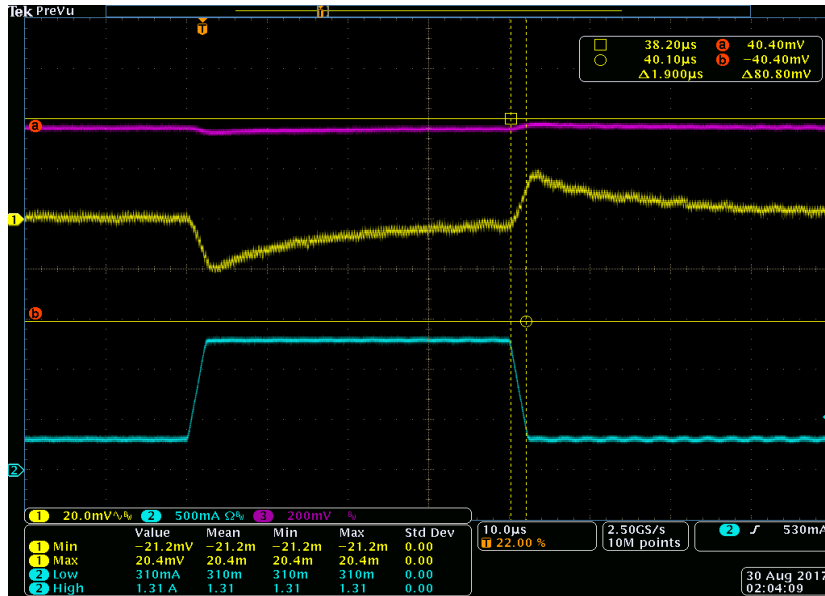

Figure 19: Buck2 Transient Response,  $V_{OUT} = 1.35\text{ V}$ , 1 A Step

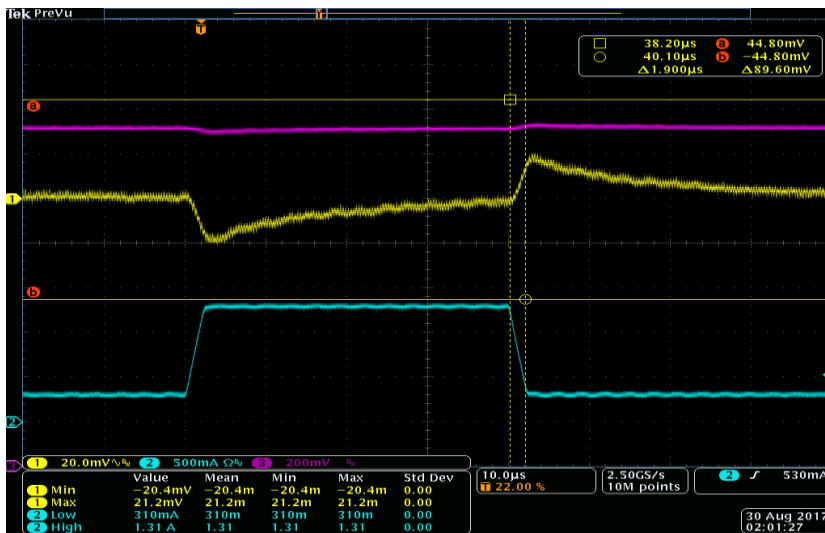

Figure 20: Buck2 Transient Response,  $V_{OUT} = 1.5\text{ V}$ , 1 A Step



Power Solutions for Xilinx Artix-7 and Zynq-7000

Table 13: Buck3 Transient Load Results

Buck3	Transient Load			Specification Limit (mV)		Measured (mV)	
	Low (mA)	High (mA)	%	-3 %	3 %	Min	Max
2.5	310	1310	40 %	-75	75	-41	35
2.5	310	1570	50 %	-75	75	-55	49
3.3	310	1310	40 %	-99	99	-45	37
3.3	310	1570	50 %	-99	99	-55	51

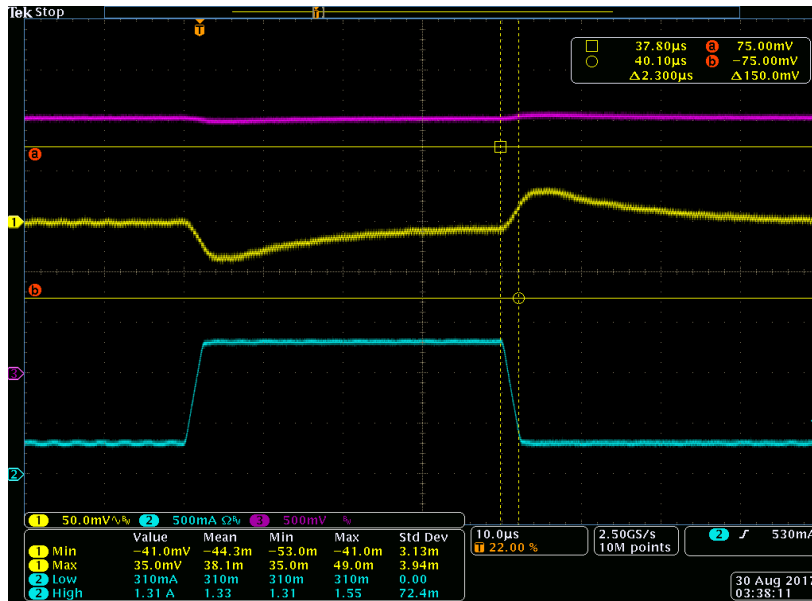

Figure 21: Buck3 Transient Response,  $V_{OUT} = 2.5\text{ V}$ , 1 A Step

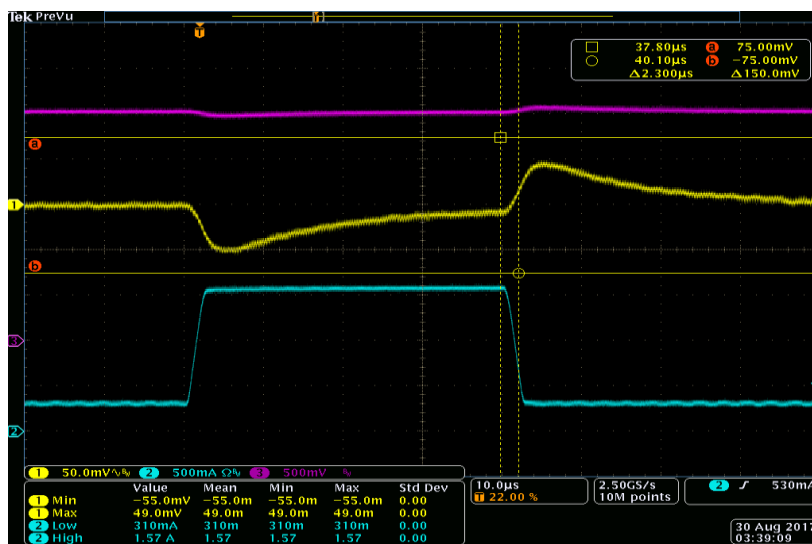

Figure 22: Buck3 Transient Response,  $V_{OUT} = 2.5\text{ V}$ , 1.25 A Step

Power Solutions for Xilinx Artix-7 and Zynq-7000

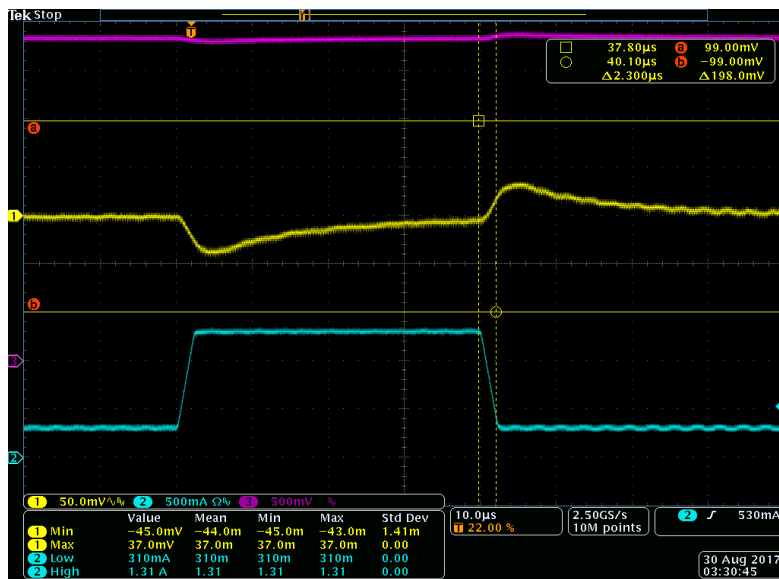

Figure 23: Buck3 Transient Response,  $V_{OUT} = 3.3\text{ V}$ , 1 A Step

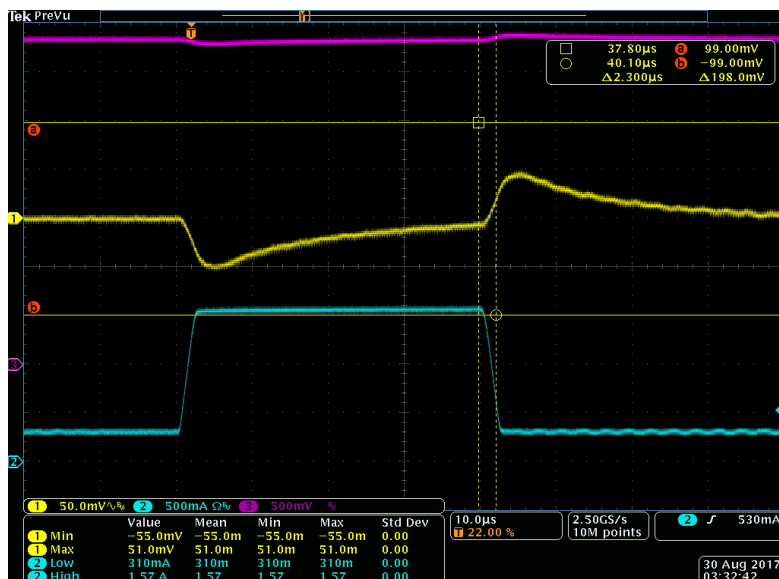

Figure 24: Buck3 Transient Response,  $V_{OUT} = 3.3\text{ V}$ , 1.25 A Step

Power Solutions for Xilinx Artix-7 and Zynq-7000

6.2.5 Reference Measurements

The operating performance of the PMIC is affected by the performance of the voltage and current references. This section shows the performance of the voltage and current references over temperature.

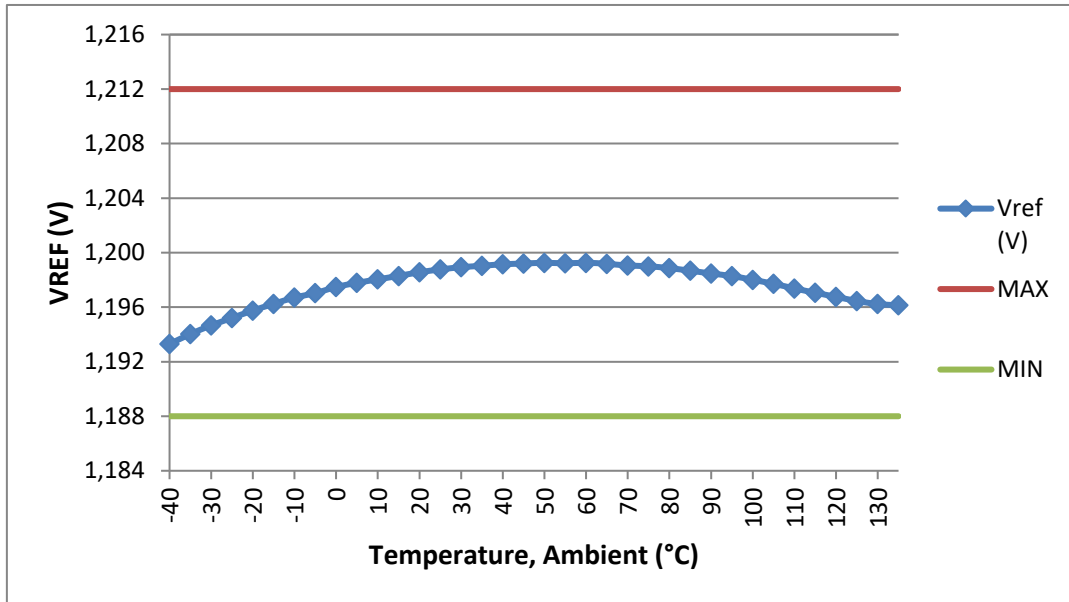

Figure 25: V<sub>REF</sub> Over Temperature

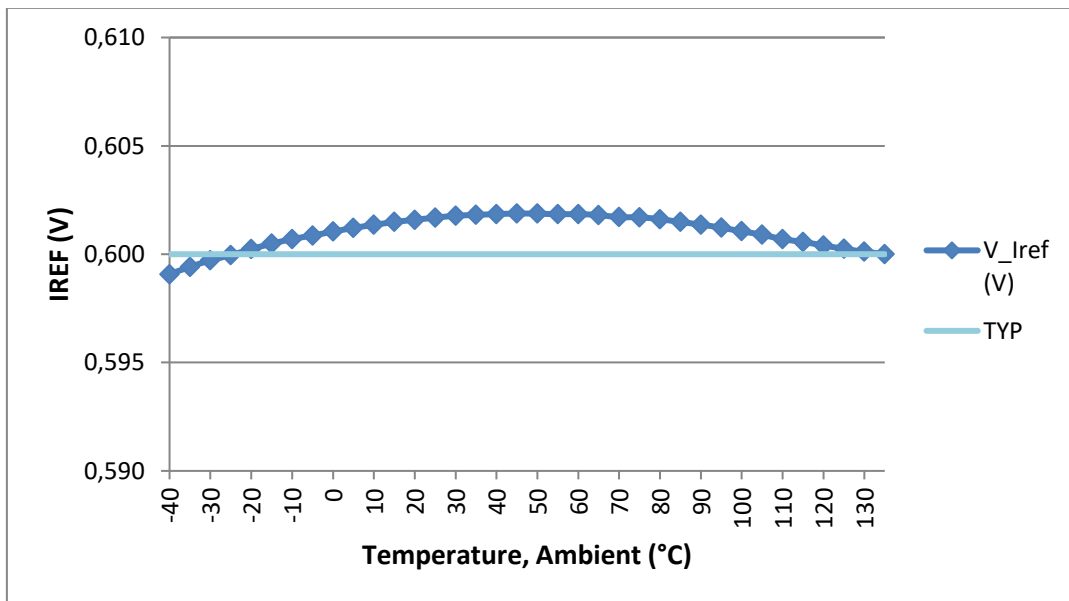

Figure 26: I<sub>REF</sub> Over Temperature

Power Solutions for Xilinx Artix-7 and Zynq-7000

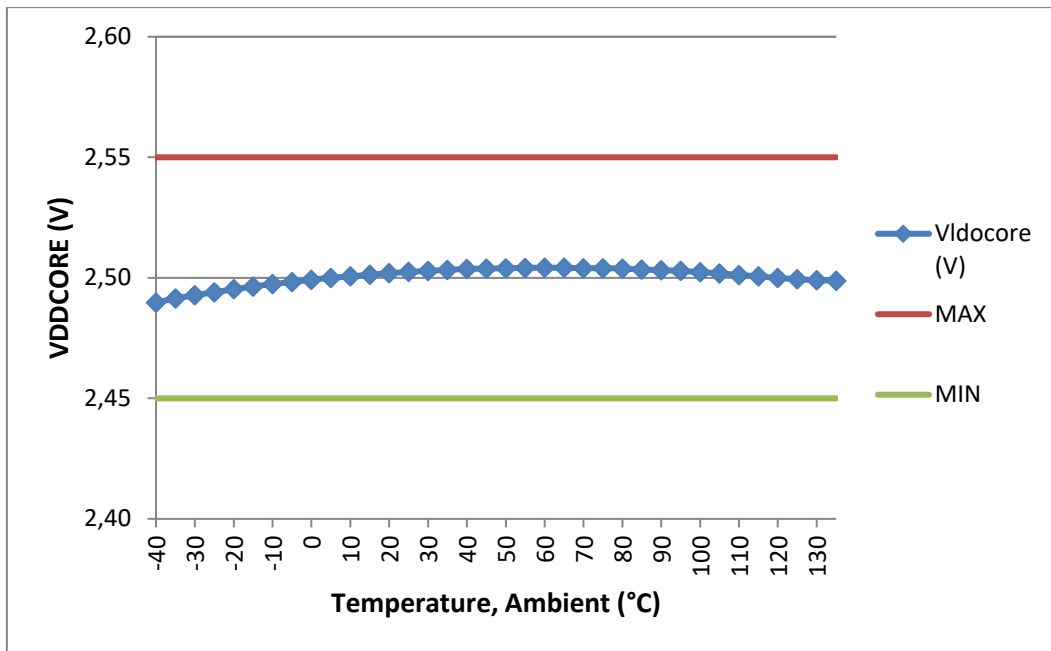

Figure 27: VDDCORE Over Temperature

## 7 Conclusions

The Dialog range of system PMICs can support the whole Artix-7 family of devices from Xilinx. From the DA9062 which is ideal for the smaller members of the Artix-7 family, to a combination of the DA9063L and a DA9211 sub-PMIC which, when combined, can service the requirements of the largest member of the Artix-7 family. This flexibility can also be extended to support the Zynq -7000 family of devices. The Dialog system PMICs, through the use of OTP, provides the ability to customize the power solution to optimally meet the needs of the most complex system.

### Revision History

Revision	Date	Description
1.0	08-May-2018	Initial version.
1.1	24-Feb-2022	File was rebranded with new logo, copyright and disclaimer

---

## Power Solutions for Xilinx Artix-7 and Zynq-7000

### Status Definitions

Status	Definition
DRAFT	The content of this document is under review and subject to formal approval, which may result in modifications or additions.
APPROVED or unmarked	The content of this document has been approved for publication.

### RoHS Compliance

Dialog Semiconductor's suppliers certify that its products are in compliance with the requirements of Directive 2011/65/EU of the European Parliament on the restriction of the use of certain hazardous substances in electrical and electronic equipment. RoHS certificates from our suppliers are available on request.

## IMPORTANT NOTICE AND DISCLAIMER

RENESAS ELECTRONICS CORPORATION AND ITS SUBSIDIARIES (“RENESAS”) PROVIDES TECHNICAL SPECIFICATIONS AND RELIABILITY DATA (INCLUDING DATASHEETS), DESIGN RESOURCES (INCLUDING REFERENCE DESIGNS), APPLICATION OR OTHER DESIGN ADVICE, WEB TOOLS, SAFETY INFORMATION, AND OTHER RESOURCES “AS IS” AND WITH ALL FAULTS, AND DISCLAIMS ALL WARRANTIES, EXPRESS OR IMPLIED, INCLUDING, WITHOUT LIMITATION, ANY IMPLIED WARRANTIES OF MERCHANTABILITY, FITNESS FOR A PARTICULAR PURPOSE, OR NON-INFRINGEMENT OF THIRD-PARTY INTELLECTUAL PROPERTY RIGHTS.

These resources are intended for developers who are designing with Renesas products. You are solely responsible for (1) selecting the appropriate products for your application, (2) designing, validating, and testing your application, and (3) ensuring your application meets applicable standards, and any other safety, security, or other requirements. These resources are subject to change without notice. Renesas grants you permission to use these resources only to develop an application that uses Renesas products. Other reproduction or use of these resources is strictly prohibited. No license is granted to any other Renesas intellectual property or to any third-party intellectual property. Renesas disclaims responsibility for, and you will fully indemnify Renesas and its representatives against, any claims, damages, costs, losses, or liabilities arising from your use of these resources. Renesas' products are provided only subject to Renesas' Terms and Conditions of Sale or other applicable terms agreed to in writing. No use of any Renesas resources expands or otherwise alters any applicable warranties or warranty disclaimers for these products.

(Disclaimer Rev.1.01 Jan 2024)

### Corporate Headquarters

TOYOSU FORESIA, 3-2-24 Toyosu,  
Koto-ku, Tokyo 135-0061, Japan  
[www.renesas.com](http://www.renesas.com)

### Trademarks

Renesas and the Renesas logo are trademarks of Renesas Electronics Corporation. All trademarks and registered trademarks are the property of their respective owners.

### Contact Information

For further information on a product, technology, the most up-to-date version of a document, or your nearest sales office, please visit [www.renesas.com/contact-us/](http://www.renesas.com/contact-us/).