

INDUSTRIAL AUTOMATION

Enabling the Industry 4.0 infrastructure

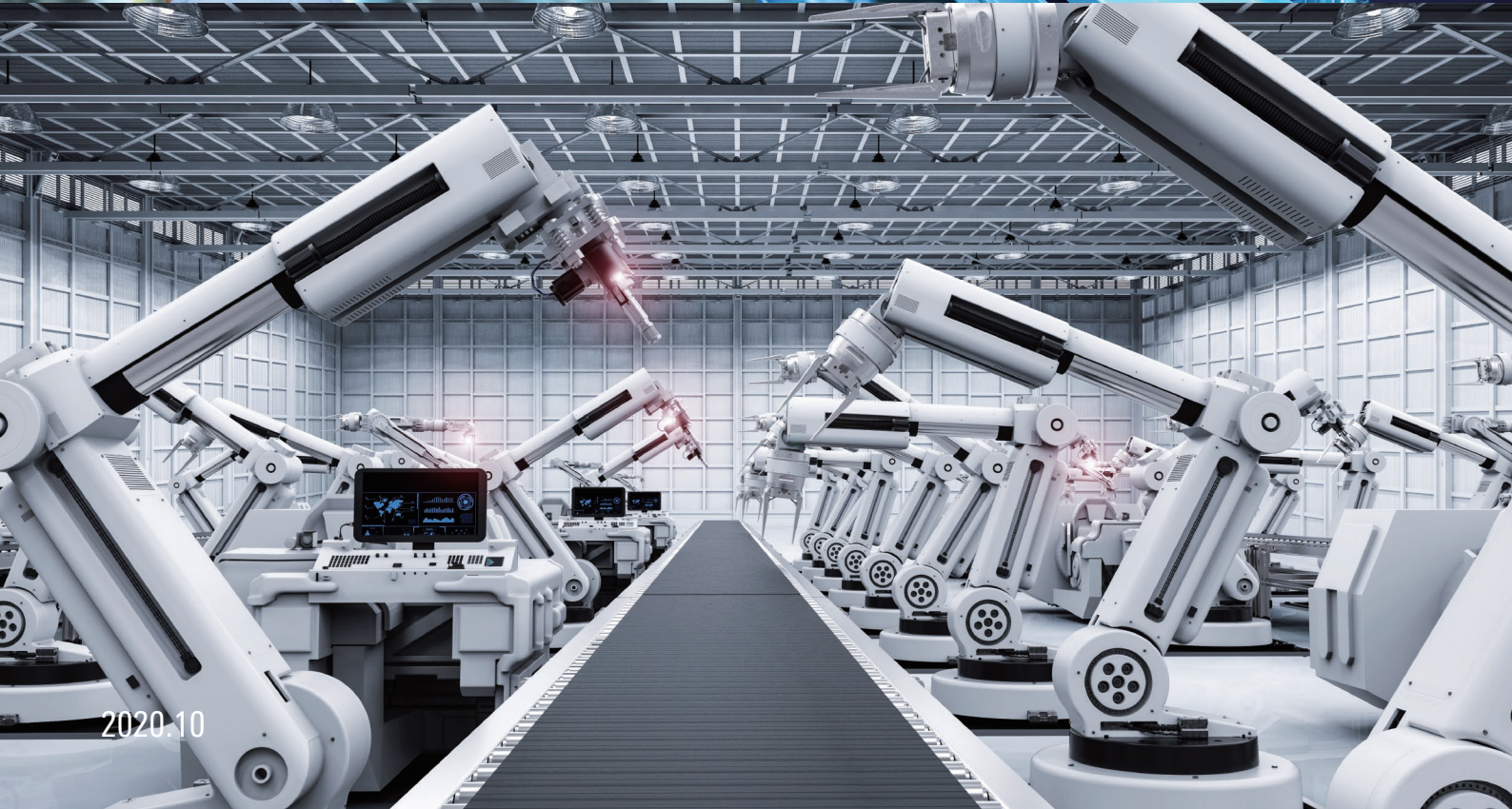

Industrial Automation

Be it for drives, control, sensor, and communication applications, Renesas accelerates application development with dedicated industrial automation solutions. Furthermore providing functional safety and security technology from Renesas pave the path to Industry 4.0 and Industrial Internet of Things applications.

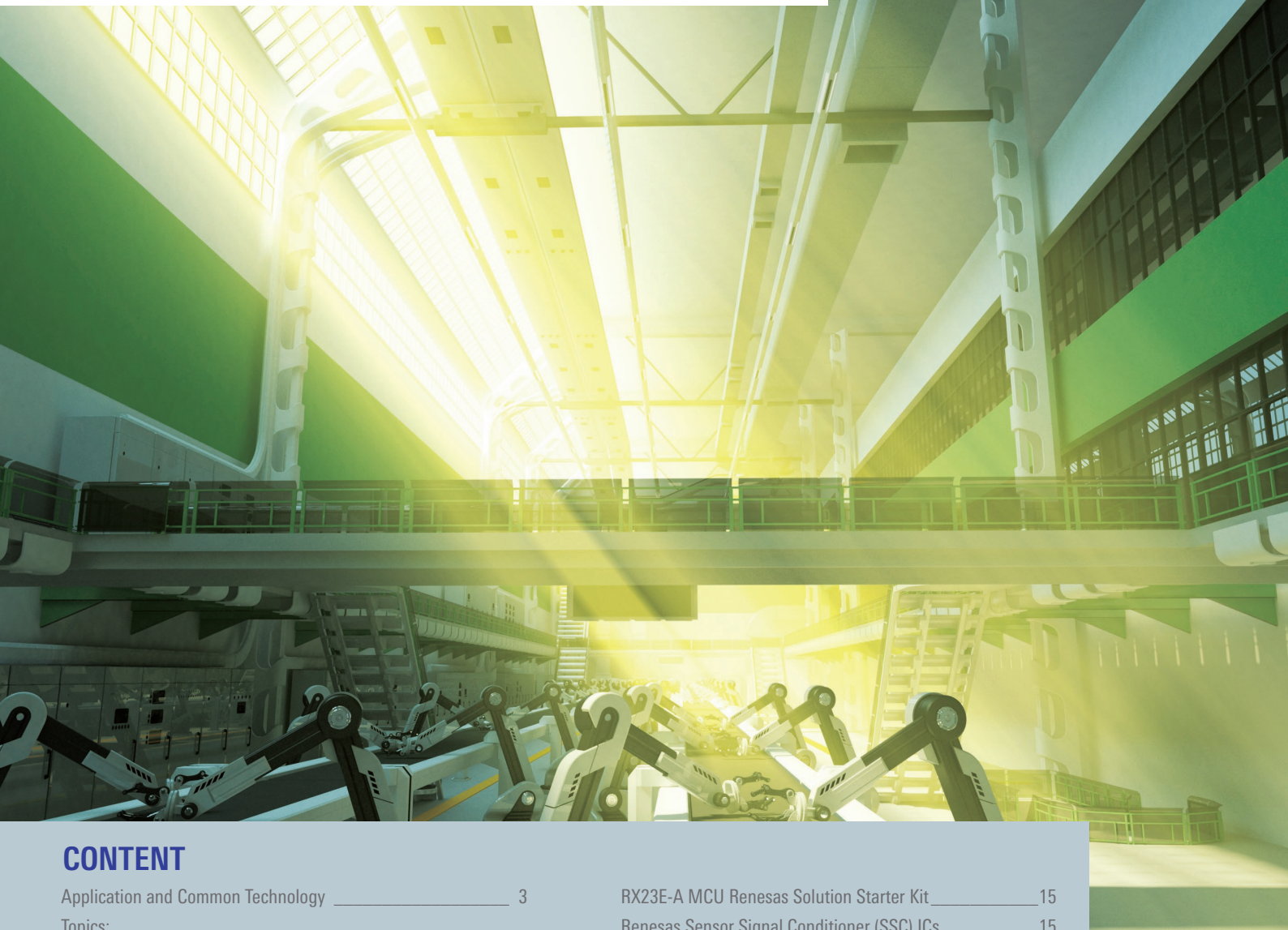

CONTENT

Application and Common Technology _____ 3

Topics;

RZ/N Series: Multi-protocol industrial ethernet controller _ 4

R-IN32M3 Module: Industrial ethernet module _____ 5

ASI4U-V5: ASi-5 Transceiver ASSP _____ 6

R-IN32M4-CL3: Industrial ethernet controller for CC-Link IE TSN _ 7

Functional Safety Solutions for Industrial Applications ____ 8

Security Solution _____ 10

Resolver Motor Control Solutions Featuring Superlative

Cost and Performance Characteristics _____ 12

RX72M, RX72N, RX66N Expands Equipment Control and

Networking Portfolio with 32-Bit MCUs _____ 14

RX23E-A MCU Renesas Solution Starter Kit _____ 15

Renesas Sensor Signal Conditioner (SSC) ICs _____ 15

Renesas Recommend per Application;

Industrial Network Solution _____ 16

Motion and Drives (AC Servo System) _____ 18

Motion and Drives (General Purpose Inverter System) ____ 22

Control (Programmable Logic Controller) _____ 26

Control (Remote IO System) _____ 30

Sensor Interface _____ 36

MCU and SoC Development Tools _____ 38

Application and Common Technology Compatible

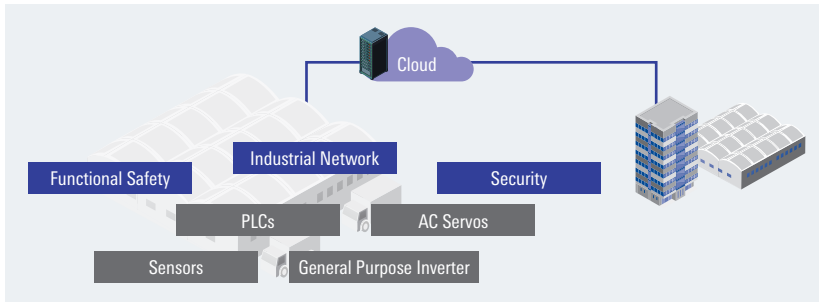

Renesas offers optimized solution for each application such as Motor Control, Controllers, and Sensors. Also offers solutions for common technology such as Industrial Network, Functional Safety, and Security.

Embedded Processing Devices

8/16bit MCU		32bit MCU		32/64bit MPU	ASSP
Renesas Core		Arm® Core			
<p>Low Power</p> <p>Features: Ultra-low energy Low pin count lineup available</p>	<p>Power Efficiency</p> <p>Features: Superior power efficiency High-capacity flash memories Broad lineup</p>	<p>Arm® Ecosystem</p> <p>Features: High efficiency Advanced security Flexible Software Package</p>	<p>Renesas Synergy™</p> <p>Qualified Platform</p> <p>Features: Qualified software and tools</p>	<p>High Performance</p> <p>Features: Multi-core up to 8 cores Linux or RTOS available High-capacity on-chip RAM DRP*1 image processing acceleration DRP-AI DNN acceleration Note: 1. DRP: Dynamically Reconfigurable Processor</p>	<p>Industry</p> <p>Features: Accelerator for Industrial ethernet Multiprotocol</p>

A full selection of analog and power devices is also available. Contact Renesas for details.

What are Winning Combinations?

Winning combinations are comprehensive solutions that combine complementary Renesas products from our portfolio, such as analog + power + embedded processing devices. These winning combinations bring together products that work together optimally, enabling customers to speed up the design process and bring their finished products to market more quickly. With the focus on the industrial, infrastructure, and automotive fields, Renesas is working to provide an optimal portfolio of products to customers and partners worldwide.



Visit the website below to see examples of a variety of solutions for industrial equipment.

<https://www.renesas.com/us/en/solutions/idt.html>

Application	Title	ID
Network	Real-Time Industrial Ethernet Switch with RZ/N1D	EU012
	Real-Time Industrial Ethernet Switch (Low Cost) with RZ/N1S	EU013
	4-20mA Current Loop System for Industrial Control	US110
	4-20mA Current Loop Transmitter	US199
	CC-Link IE TSN Solution	JP135
	Modbus ASCII/RTU Slave Board	JP124
PLC	Over-The-Air Update Module for PLC Applications	CN194
Robot	Robotics Solution with RZ/A2M	JP104
Motor	AC Servo Motor Control with Industrial Network Connections	CN032
	High-Voltage Motor Drive	US016
	48V Position Control	US043
	High-End Electric Fan with BLDC control	CN085
Sensor	IO-Link Enabled Sensor System	US020
	Multi-Sensor Module for Industrial Ethernet	EU025
	Multi-Sensor Platform for Asi-5	EU036
	Time of Flight (ToF) Sensor Module	JP084
	Precision Industrial Temperature Control	US085
	Isolated Multi-channel Sensing Solution	JP141
	Industrial Sensor Network Solution	JP136
Industrial Sensing with IO-Link Interface	US026	

Contributing to the Realization of a Smart Society with Solutions for Industrial Network Equipment

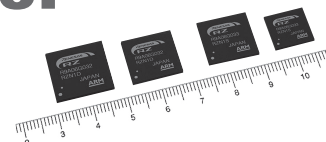

RZ/N Series: Multi-protocol industrial Ethernet controller

A one-chip solution that enables implementation of a main field network and highly reliable control network at the same time.

1. Provides optimized microcontrollers for a variety of industrial network applications

The three CPU types lineup and integrated 5-port gigabit Ethernet switch make it possible to provide the optimal microcontrollers for a wide range of industrial network applications.

- Lineup of three CPU types for excellent hardware scalability: Dual-core Cortex®-A7 (500MHz × 2), single-core Cortex®-A7 (500MHz), and R-IN engine only (125MHz).
- 5-port gigabit Ethernet switch and two independent MAC units support applications such as PLC devices and Ethernet switches. Integration of peripheral components helps reduce BOM cost.

2. Integrated R-IN engine (accelerator) supporting main industrial Ethernet protocols

The R-IN engine accelerator supports a wide range of protocols and enables high-speed processing.

It reduces the load on the main CPU (Arm® Cortex®-A7) and contributes to highly efficient application control.

Protocol stacks

EtherCAT®, EtherNet/IP®, ETHERNET Powerlink®, PROFINET®, Sercos®, CANopen®, Modbus, TCP/IP

3. Redundant network configuration reduces network downtime to zero

Advanced redundant network configuration support helps eliminate network downtime.

- Redundant network connections: Parallel Redundancy Protocol (PRP)
- Looped network connections: HSR (High-availability Seamless Redundancy), DLR (Device Level Ring), RSTP (Rapid Spanning Trees)

RZ/N Series Product Lineup

	RZ/N1D	RZ/N1S	RZ/N1L
CPU	Dual core Cortex®-A7 (500MHz) Cortex®-M3 (R-IN Engine)	Single core Cortex®-A7 (500MHz) Cortex®-M3 (R-IN Engine)	Cortex®-M3 (R-IN Engine)
Internal Memory	2MB (ECC)	6MB (ECC)	6MB (ECC)
DDR I/F	○	×	×
LCD Controller	○	○	×
Ethernet Port	Max 5 port	Max 5 port	3 port
Redundancy	HSR, PRP, DLR	PRP, DLR	DLR
Package	400BGA / 324BGA 17mm/15mm	324BGA / 196BGA 15mm/12mm	196BGA 12mm

RZ/N Series Target Application



PLC industrial controllers

Industrial switches

Sensor hubs

Gateways

Communication modules

Remote I/O

Industrial Ethernet Module

R-IN32M3 Module

The new Industrial Ethernet Module (R-IN32M3 Module) is a certified hardware and software solution that allows an engineer to speed-up the development of a product and bring it fast to the market. Based on Renesas technology and quality standards, the module includes certified software of leading Industrial Ethernet protocols PROFINET® and EtherNet/IP™. Other industrial protocols such as EtherCAT® are in preparation and will be available soon. In addition, the module includes a high-speed SPI interface to communicate with the application controller. With Software Abstraction Layer, the device application can easily be connected to the module protocol software. This allows developers to easily implement various industrial Ethernet protocols and focus on developing their application software.



Key Features

- 2-port RJ45 connector with the support of the following Industrial Ethernet protocols:
 - PROFINET RT conformance class B
 - EtherNet/IP
 - EtherCAT (middle 2020)
- High speed SPI interface to connect the application CPU/MCU
- Firmware update as well as application CPU/MCU possible
- Comprehensive tool support and examples in source code
- Dimension: 50 × 34 × 12mm
- Power supply: 3.3 ±0.15 VDC
- Operation temperature: -40 to 70 degC
- Order: RY9012A0000GZ00#001(30pcs, tray), #002(1pc, box)

Easy Setup for Faster Time to Market

Connect your Application with the Intelligent RJ45 to Industrial Ethernet fieldbus system

The Industrial Ethernet Protocol for the fieldbus communication runs inside the Renesas R-IN32M3 Module. With the corresponding API of the protocol library (Abstraction Layer) the communication is exported to the application MCU via the SPI interface. The application MCU has full control of the Industrial Ethernet protocol without investing in the CPU power to run the protocol. This relieves the application MCU from the often-crucial CPU load to run the real-time communication protocol. Renesas provides sample application and drivers for the application MCU in source code. This helps the saves development time and cost and enables a fast time to market. Via the Ethernet interface the module allows a software update of its own firmware as well as the application MCU.

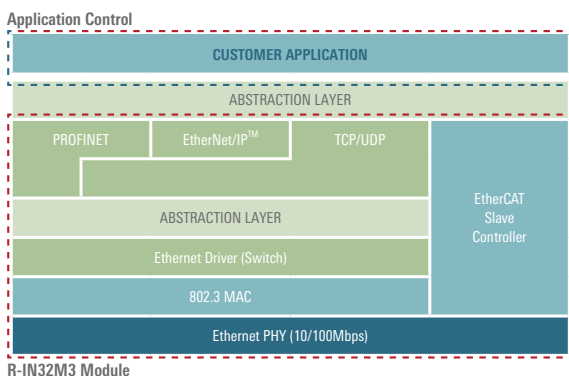

Figure: Software Structure

Development Environment

Ready to evaluate and develop

Solution set

- [Kit.] R-IN32M3 Module + Adapter Board
- [soft] Synergy SK-S7G2 sample application*
- [FW] R-IN32M3 Module FW
- [tool] Management Tool
- [doc] Quick Start Guide
- [doc] Design Guide



Note: Need Synergy SK-S7G2 Starter Kit.

Target Application

The Industrial Ethernet Module solution comes in a size of a dual port RJ45 connector and is targeted to support various network topologies and industrial network slave applications like sensors and transmitters, gateways, operator terminals and remote I/O solutions.

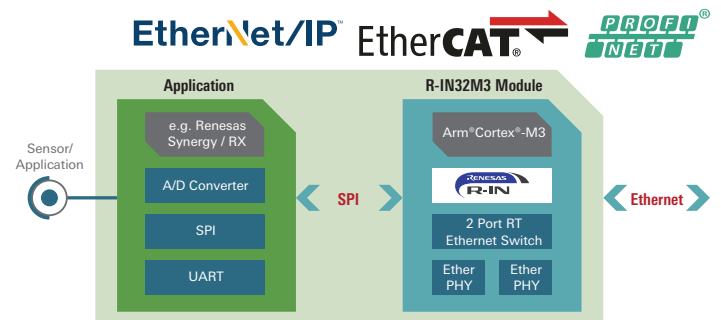

Figure: Easy Connection Between Application

ASI4U-V5: Fully Compliant ASi-5 Transceiver ASSP

The ASI4U-V5 is the industry's first silicon solution to fulfill the ASi-5 (Actuator-Sensor-Interface version 5) standard for industrial network equipment that enables comprehensive Industry 4.0 applications. The ASI4U-V5 ASSP comes with a completely verified and field-proven firmware that fully implements ASi-5. Hence, integration of ASi-5 into any application is very easy, as the complexity of the fieldbus is hidden by the chip and the firmware.

Key Features

- Fully compliant to the AS-i version 5 standard
- Fully compatible to the AS-i version 3 standard
- The solution consists of the ASSP and a self contained ASi-5 firmware
- 64-pin QFN package
- Support for simple slave applications (digital-I/O connection)
- Support for complex slave applications (SPI/IF to the application)
- Operating temperature -40°C to +85°C
- Supply voltages: 5V and 3.3V
- Package dimensions:
9 × 9 mm, 0.5 mm pitch
- Part Number:
R9J06G039UGNP

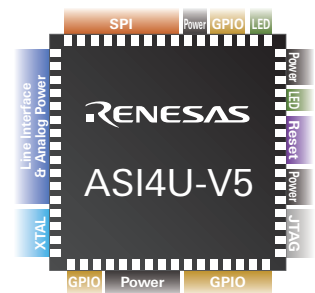

ASi-5 Key Technology Advantages

Faster and more efficient for Industry 4.0 applications

- ASi-5 supports 1.2ms cycle time with a jitter of less than 10ns vs 5ms of ASi-3
- ASi-5 allows for 96 devices being attached to the same cable vs 62 in ASi-3
- ASi-5 can run up to 200m cable vs 100m in ASi-3
- ASi-5 supports diagnostics and event handling needed for industry 4.0 applications

Robustness

- ASi-5 is the most robust field bus due to its 3D redundancy concept, which ensures that all data reaches the destination in time without any errors. Robustness is a key asset in industrial communication.

Ease of integration

- ASI4U-V5 is an ASi-5 silicon solution, which consists of the ASi-5 ASSP and a fully self-contained firmware image that handles all ASi-5 specific items. Hence, it is the easiest fieldbus integration option.
- ASI4U-V5 is fully backwards compatible to ASi-3
- ASI4U-V5 supports all bus topologies (line, star, tree)
- ASI4U-V5 supports and easy integration with IO-Link

Application Examples

Supports simple slave and complex slave applications

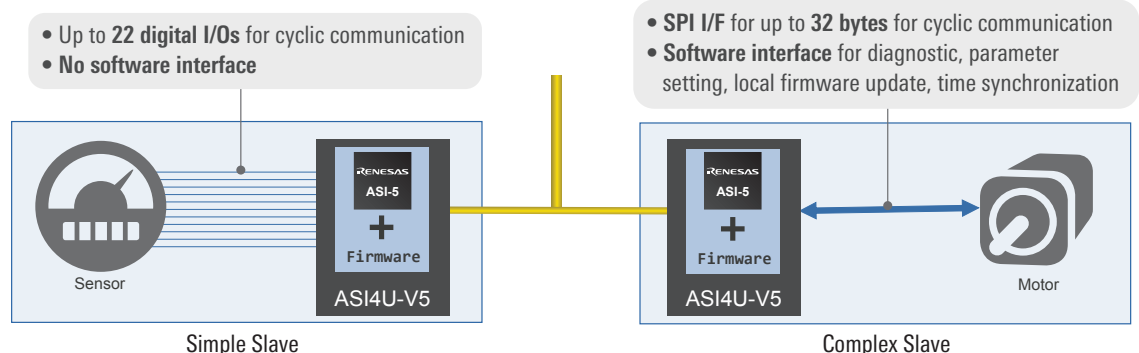

R-IN32M4-CL3: Industrial Ethernet Controller with CC-Link IE TSN Support

The R-IN32M4-CL3 is a communication SoC with hardware support for CC-Link IE TSN. In addition to R-IN engine technology it implements a gigabit Ethernet compatible PHY, making it a one-chip solution for the latest in TSN communication.

Key Features

- Time synchronization accuracy between devices of $\pm 1 \mu\text{s}$ or less (CC-Link IE TSN Class B support)
- 2-port gigabit Ethernet compatible PHY, CPU, and RAM (1.3MB) on an one-chip
- R-IN engine for same multi-protocol support as preceding product
- Compact package and on-chip PHY regulator for reduced mounting area
- Low power consumption (35% less than R-IN32M3-CL2)

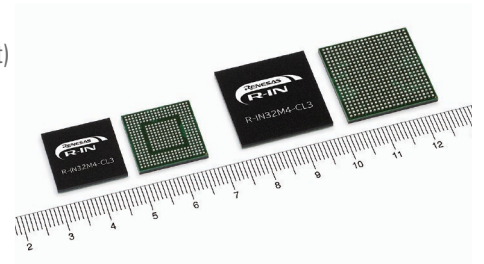

Product Specifications

- CPU Cortex-M4 (100MHz)
- RAM 1.3MB ECC support
- Power supply voltage $3.3\text{V} \pm 5\%$, $1.15\text{V} \pm 5\%$
- I/O 106 channels (max.)
- 2 Ethernet ports (integrated 10/100/1000 PHY)
- Numerous peripheral functions
 - 32-bit external MCU interface
 - UART
 - I²C
 - CSI
 - Timer
- Operating temperature range
 - T_j = -40 to +125°C
 - T_a = -40 to +85°C

R-IN32M4-CL3 Block Diagram

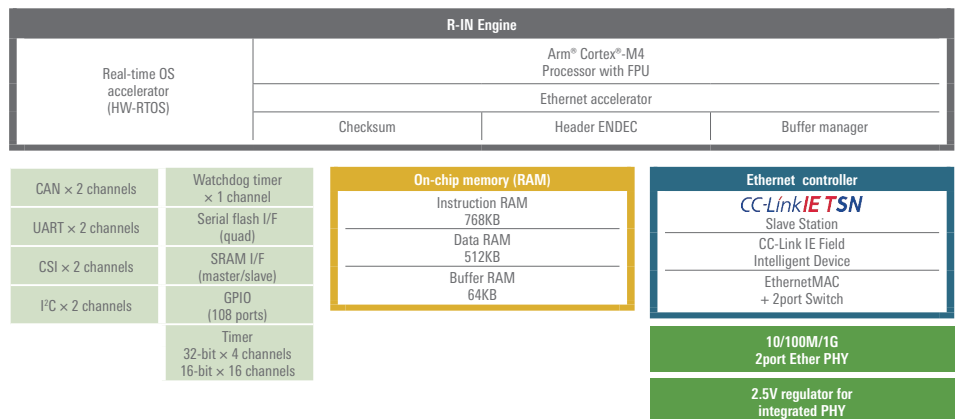

Development Environment

Verify your CC-Link IE TSN communication application within an hour of launching the development environment!

Solution set

- Startup manual
- Evaluation board mounted with R-IN32M4-CL3
- Sample software*
 - CC-Link IE TSN
 - CC-Link IE Field
 - Peripheral drivers
- Settings file for master station
- User's manuals

Note: Supplied as IAR Embedded Workbench® for ARM projects.

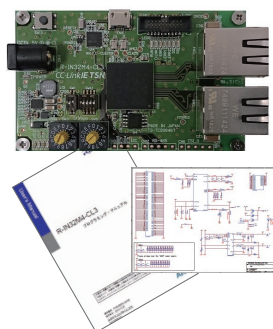

Advantages of CC-link IE TSN

Time synchronization and time sharing among devices makes possible ultrahigh-speed, highly accurate motor control. It is also possible to seamlessly connect information technology (IT) networks and operational technology (OT) networks so they can interoperate with each other, enabling flexible support for multiproduct variable-quantity production in which models and manufacturing volumes can be changed in real time for higher plant productivity overall.

IEC16508 Certified Functional Safety Solutions for Industrial Applications

The crucial importance of functional safety is rising in the industrial field, aiming to maintain safety when malfunctions occur in order to prevent breakdowns and accidents during planned operation, adverse impacts from operator injuries, and associated economic losses. Today, not only the EU's Machinery Directive but also the industrial safety and health laws in many countries require industrial machinery meets functional safety standards. As the scope of standards for functional safety expands in many industrial fields, Renesas provides IEC61508 certified functional safety software, development tools, verified reference board and documents to support our customers reduce the development task and time. Renesas been the 1st MCU supplier to complete the verification of the core self-test and been expanding safety solutions which is certified and compliant to IEC61508 by TÜV Rheinland.



TUV Certified Solution

Safety system development is very complexed process. Therefore it is very important to build up an application piece by piece considering functional safety standards in both hard and software modules. Ideally the parts should come with certification. While every application is different per usage for safety components, hard as well as software, Renesas provides less extensive workload for safety system developers.



Renesas Solutions vs Certification Process

Renesas solutions covers certification process and will shortens customer's actual development TAT. Renesas certified SW will do the functionals safety diagnosis on MCU which means customer can focus more on application development.

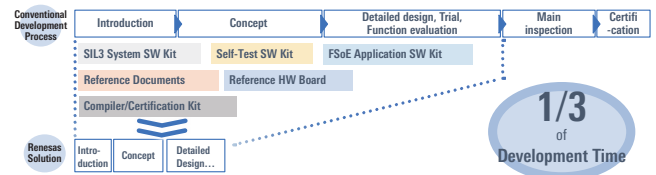

Target Application

- Industrial Motor Drives
- Safety Controllers
- Programmable Logic Controllers
- Safety Sensors

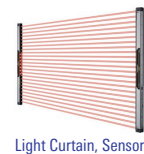

Usage Example : Safe Motor Control

Application and Safety Functionality separated
 Two channel concept (1oo2 architecture)
 Cross Monitoring
 Standard Compliant

- IEC 61508 SIL3
- ISO 13849 Ple Cat4
- IEC 62061 SILCL3

 Safety functions according to IEC61800-5-2 (e.g. STO, SLS, etc.)

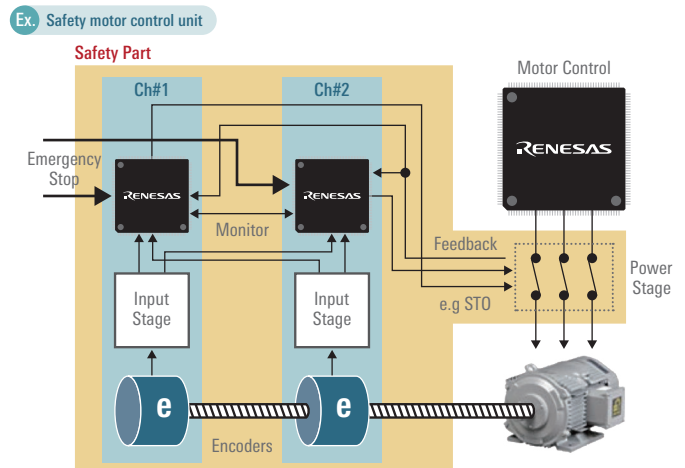

Renesas Functional Safety Solution List

- Self-test SW Kit***;
Free package of MCU Self-diagnostics SW for diagnosing CPU, ROM, and RAM in MCU.
- SIL3 System SW Kit***;
Package of Functional Safety Platform SW for cross-monitoring dual MCU and controlling user's application behavior. Evaluation version available.
- Safety Network Protocol***;
SIL3 certified and FSoE.
- Reference Document***;
Guidebook for safety system design following IEC61508 standard. Safety-related documents covering diagnostic, control methods, required CPU performance, system architecture reference, etc. This document is apart from MCU.
- Reference Hardware Board**;
Evaluation board verified by certification body. Packed with functional safety know-how e.g. designed incl diagnosis and monitoring circuit required by functional safety standard. Can immediately start prototype and SW development. Renesas Safety SWs can also be evaluated.
- Safety certified compilers***;
Renesas original certified compiler and certification kit. Certified IAR compiler also available from IAR.

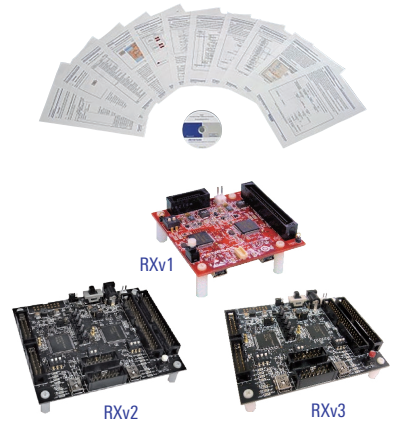
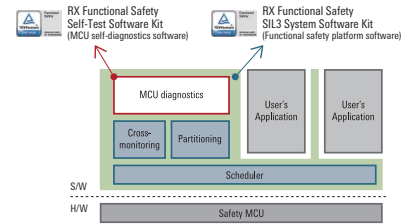

Renesas Functional Safety Overview & Supporting Family

Based upon market requirement, Renesas have completed the supporting menu on RX Family from RXv1 core family also up to RXv3 core family today. This year Renesas have extended the supporting cores to RXv3 and released safety network protocol : FSoE (Functional Safety over EtherCAT). Also our first generation of RA Family started its solution support, and to be extended.

	RX Family			RA Family
	RXv1*	RXv2*	RXv3*	RA4M1, RA6M1 RA6M2, RA6M3
SIL3 System Software Kit		✓	✓ NEW	
Self-Test Software Kit	✓	✓	✓ NEW	✓ NEW
FSoE Application Software Kit		✓ NEW	✓ NEW	
Reference Documents			✓	
Reference Hardware Board	✓	✓	✓ NEW	
Safety Compilers & Certification Kit	✓	✓	✓	✓ NEW

Note: RXv1 : RX631, RX63N, RX111, RX113, RX130
 RXv2 : RX71M, RX651, RX65N, RX64M, RX24U, RX230, RX231, RX24T, RX23T, RX23E-A, RX23V
 RXv3 : RX72M, RX72N, RX72T, RX66T, RX66N

New Solution of 2020

RXv3 Line-up Extension

- Self-test SW Kit*
- SIL3 System SW Kit*
- Safety Network Protocol*
- Reference HW Board
- Safety certified compilers*

Above kits will be supporting RXv3 core family from this year.

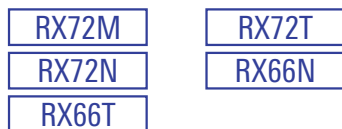

Note: License agreement required beforehand. Please contact your local Sales office for further information

Safety Network Protocol

- FSoE*

Software kit of SIL3 certified stack included network communication i/f between safety and non-safety input. The stack runs on SIL3 System SW and Self-test SW which will do all the diagnosis task of safety monitoring of MCU

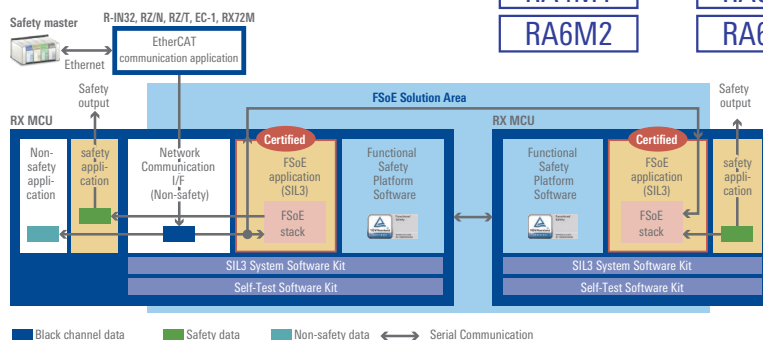

RA Family

- Self-test SW Kit*

For customers who want Arm®, Renesas released IEC61508 certified basic self-test SW.

Supporting from RA4M1, RA6M1, RA6M2, RA6M3, and to be extended.

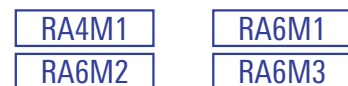

Renesas Security Solution Contribute to Realize Safe and Secure Industrial Automation

Industry 4.0 is gaining its speed. By ensured security into machines to machines network in the factory will maximize the value of connected factory. Renesas chip security technology and solution will be the root of trust of your product, contributing robust and securing the system.

Confidentiality

Visualization of the data is one of value brought by connected factory — The exchanged data between machines must be properly protected from eavesdropping.

Integrity

Availability of the factory machines are rely on the integrity of the program and data stored in silicon — must be protected from unauthorized tampering.

Authenticity/Availability

Is your installed machine or parts is the genuine? For connected factory management will require an authentication between machines to machine, main unit and replacement parts.

Products	Functions
RZ/T1	<ul style="list-style-type: none">• JTAG connection lock / JTAG connection certification• Secure Boot
RZ/A2M	<ul style="list-style-type: none">• JTAG connection lock, JTAG connection certification• External ROM program tamper checking• Decryption of encrypted external ROM programs and deployment to external memory• External ROM dead copy detection
RZ/G Series	<ul style="list-style-type: none">• Secure Kernel Boot• Encrypted communication• Basic encryption library
RZ/N1D, RZ/N1S	<ul style="list-style-type: none">• Secure Boot• JTAG lock
RX231, RX651/N, RX66T, RX72T, RX72M, RX72N, RX66N	<ul style="list-style-type: none">• Trusted Secure IP• Secure Boot• Encrypted communication• Secure update

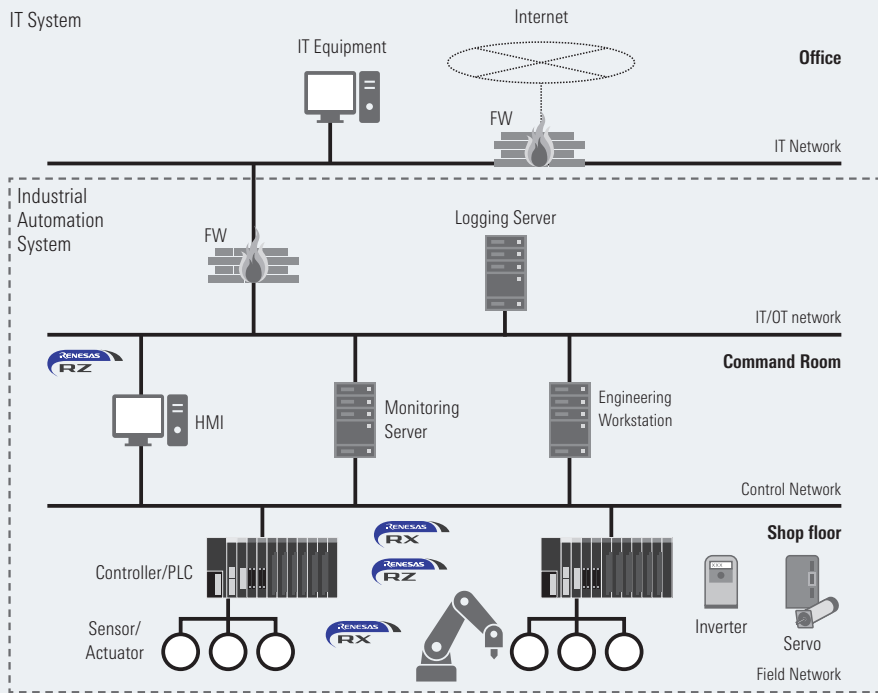

Our device solution contributes to secure the IA products

HMI <ul style="list-style-type: none"> • RZ/A • RZ/G 	Controller/PLC <ul style="list-style-type: none"> • RZ/N1D • RZ/G 	Sensor/Actuator <ul style="list-style-type: none"> • RZ/N1S • RX231, RX651/65N 	Servo/Inverter <ul style="list-style-type: none"> • RZ/T1 • RX66T, RX72T
---	--	---	---

Security Solutions

In recent years, the creation of new added value for the Internet of Things (IoT) has been gaining attention. On the other hand, since IoT devices connect to the Internet, they are exposed to risks such as eavesdropping, tampering, and viruses, and such harmful incidents are also seeing an increase in number. Consequently, the demand for security features is increasing for devices that previously didn't need them.

Robust Security with Trusted Secure IP

RX security solutions implement Root of Trust for IoT devices using encryption by key data that is protected by a strong Trusted Secure IP and an authentication program using a memory-protection function. By implementing security functions using an RX microcontroller (MCU), you can easily and strongly protect IoT devices against threats.

The RX65N and RX231 with Trusted Secure IP are CAVP certified under the FIPS 140-2 standard of the National Institute of Standards and Technology (NIST) of the United States, so the encryption algorithm employed can be used with confidence.

Threats	Security	
Eavesdropping	Encrypted communication	Secure updating: Authentication for program updating detects and prevents tampering
Tampering	Secure updating	
Virus	Secure boot	Secure boot: Authentication for program execution detects and prevents tampering

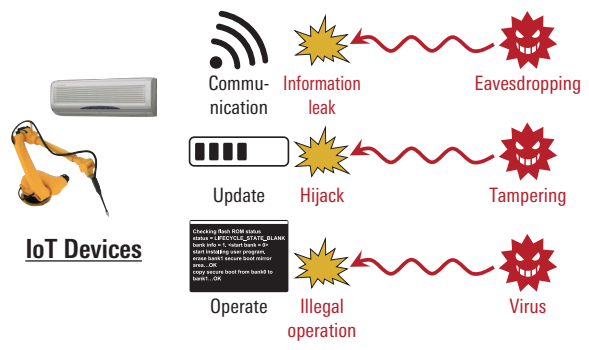

Security Hardware Implementing Root of Trust

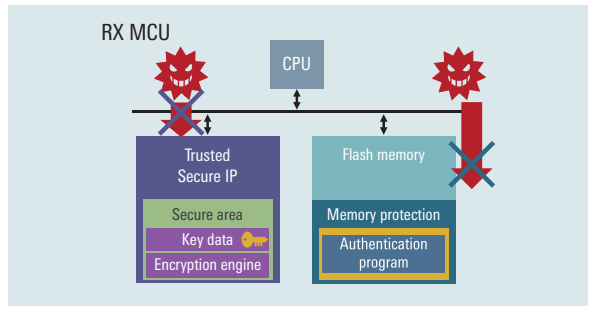

System Configuration and Our Recommendation

Overall

Applications such as industrial small robot are required motors with higher precision motor control, miniaturized form factors, and improved resistance to environmental influences. Customer can achieve high-precision motion even in harsh environments such as factory, while reducing costs and further miniaturizing industrial equipment by using smaller motors.

System Block Diagram (Industrial Small Robot)

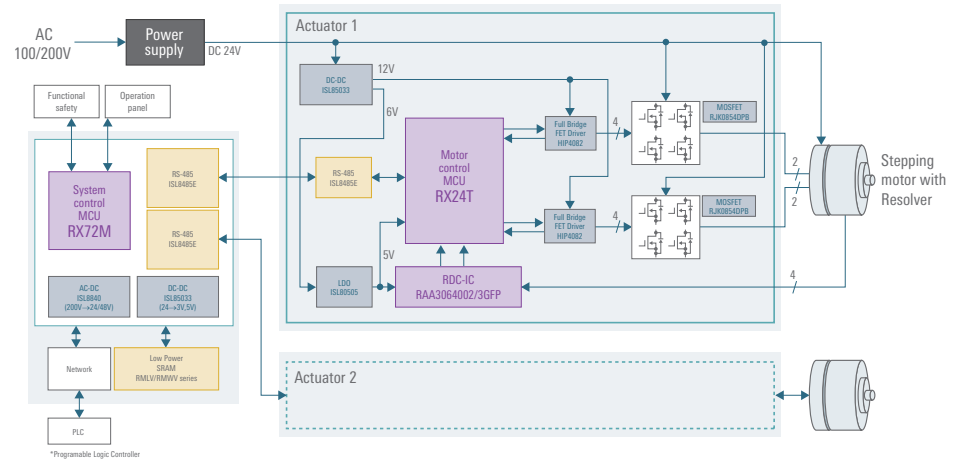

Recommended Products

Microcomputers

Category	Products	Operating Frequency (MHz)	Operating Voltage (V)	On-Chip Memory (Max.)	Features, etc.
System/Motor Control MCU	RX72M	240	2.7 to 3.6	4MB Flash 1MB RAM 32KB DataFlash	<ul style="list-style-type: none"> High-performance Rxv3 core and large memory capacity for high-precision motor control Arithmetic unit for trigonometric functions and collective register bank save function On-chip EtherCAT slave controller
	RX72T	200	2.7 to 5.5	1MB Flash 128KB RAM 32KB DataFlash	<ul style="list-style-type: none"> High performance Rxv3 core with various motor control function Large memory helps the complicated software development Enable the secure data/communication with the built-in hardware encrypt engine
	RX66T	160	2.7 to 5.5	1MB Flash 128KB RAM 32KB DataFlash	<ul style="list-style-type: none"> Arithmetic unit for trigonometric functions to speed up operations such as coordinate conversion, position control, and phase calculation (RX72T) High-resolution PWM enabling PWM waveform adjustment down to 195ps (RX66T)
	RX24T	80	2.7 to 5.5	512KB Flash 32KB RAM 8KB DataFlash	<ul style="list-style-type: none"> Support for wide range of power supply voltages, all functions necessary for motor control on a single compact chip
	RX23T	40	2.7 to 5.5	128KB Flash 12KB RAM	<ul style="list-style-type: none"> Suited for single inverter control with a built-in FPU (floating-point processing unit) that enables it to easily program complex inverter control algorithms

Analog & Power Devices

Category	Products	Main Specification	Features, etc.
RDC-IC	RAA3064002GFP (85 degree) RAA3064003GFP (105 degree)	Single-phase induced/Two phase output Rectangle waveform 5/10/20kHz, 2.5Vp-p	Simplify design in kit with RX24T Winding error correction function Electromagnetic noise reduction filter
Full Bridge FET Driver	HIP4082	80V, 1.25A Peak Driver	Independently Drives 4 N-Channel FET in Half Bridge or Full Bridge Configurations User-Programmable Dead Time (0.1 to 4.5us)
MOSFET	RJK0854DPB	Nch Single Power MOSFET 80V 25A 13mohm LFPAK	Low on-resistance, high-speed switching, and high-robustness
AC/DC	ISL8840	1A MOSFET gate driver 90µA start-up current, 125µA maximum 35ns propagation delay current sense to output	30V operation, low operating current, 90µA start-up current, adjustable operating frequency to 2MHz, and high peak current drive capability with 20ns rise and fall times.
DC/DC	ISL85033	Wide VIN Dual Standard Buck Regulator With 3A/3A Continuous Output Current	Wide input voltage range from 4.5V to 28V Adjustable output voltage with continuous output current up to 3A Adjustable switching frequency from 300kHz to 2MHz
LDO	ISL80505	High performance 500mA LDO	±1.8% VOUT accuracy guaranteed over line, load Very low 45mV dropout voltage at VOUT = 2.5V Stable with a 4.7µF output ceramic capacitor
SRAM	RMLV series RMWV series	RMLV series: Standby: 0.4µA (typ.), Access time 45ns (max.) RMWV series: Standby: 1.0µA (typ.), Access time 55ns (max.)	Industry-leading Low standby current, suitable for battery-backup memory High reliability: Extremely low soft-error rate, less than 0.1 FIT / Mbit
RS-485 driver	ISL8485E	ESD Protected to ±15kV, 5V, Low Power, High Speed Rate Limited, RS-485/RS-422 Transceivers	Data rates up to 10Mbps which features higher slew rates. Extended industrial temperature options (+125°C) Operate from a single +5V supply (10% tolerance)

RX72M, RX72N, RX66N Expands Equipment Control and Networking Portfolio with 32-Bit MCUs



Outstanding real-time performance and one-chip solutions

Overview

Launched new product, RX72N, RX66N, built around Rxv3 core. RX72N features a maximum operating frequency of 240 MHz and two Ethernet channels, and the RX66N features a maximum operating frequency of 120 MHz and one Ethernet channel. In addition to existing RX72M with EtherCAT® support, expands our MCU products portfolio by combining equipment control and networking just one chip.

RX72N Group Block Diagram

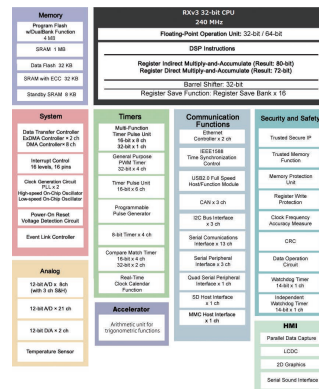

RX66N Group Block Diagram

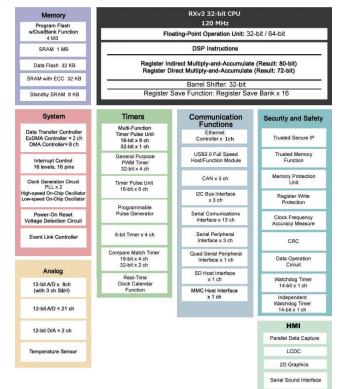

Key Features

RX72M, RX72N, RX66N

- Outstanding Real-Time performance: Industry's fastest flash memory operating that RX72M and RX72N need only one wait cycle and No wait occurs for RX66N when a cache miss occurs.
- Multiple Functions and Small Footprint: Industry's largest memory and General-purpose input/output contribute to shrink caches and reduce development time by integrating many functions into a single chip.
- Robust Security: Perfect application from various treats by Trusted Secure IP (TSIP), TSIP outputs key generation related unique ID, this avoids to use in other devices, even if the key generation is stolen.
- Advanced HMI without external RAM: LCD controller, 2D drawing engine, serial sound I/F, and 1MB SRAM realize lower barrier to adaption of HMI function.

RX72M

- Built-in EtherCAT slave controller: Adopted Beckhoff Automation's "EtherCAT Slave Controller IP Core", and advanced timers support three-phase complementary PWM outputs and encoder inputs, realize high-precision motor control through EtherCAT communication.
- Multi-Protocol support: Certified by major protocols of EtherCAT, Profinet RT and Ethernet/IP, Sample program of major protocols realize to reduce development time and cost.

New RX Portfolio

	NEW Industrial network protocol support	NEW Flagship product offering highest performance	NEW No-wait state real-time performance
Group	RX72M	RX72N	RX66N
CPU	240MHz Rxv3 core Double-precision FPU Register bank save function	240MHz Rxv3 core Double-precision FPU Register bank save function	120MHz Rxv3 core Double-precision FPU Register bank save function
Memory	4MB flash memory (120MHz read access) 1 MB SRAM	4MB flash memory (120MHz read access) 1 MB SRAM	4MB flash memory (120MHz read access) 1 MB SRAM
Network	2ch Ethernet 2ch EtherCAT + NW protocols	2ch Ethernet	1ch Ethernet

System Configuration

Multi-pin package:

Release restrictions on functionality selection due to tight program capacity and insufficient pins, and support to reduce number of components, small footprint, and development time.

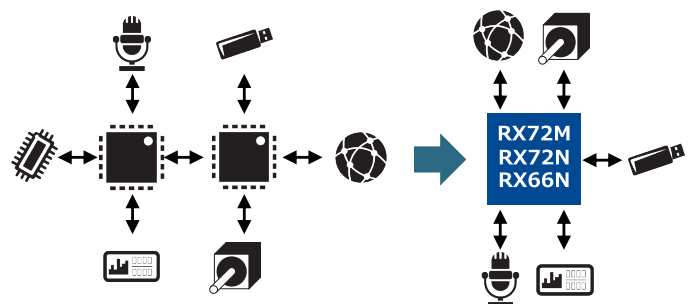

Renesas Solution Starter Kit for High-Precision Sensing evaluation of RX23E-A MCU



Kit Overview

The RX23E-A Renesas Solution Starter Kit (RSSK) includes an RX23E-A mounted evaluation board with sensor measurement peripheral circuits. By using it with software downloadable from the website, users can start evaluating analog features right after unboxing. The kit helps users shorten development period and improve time-to-market.

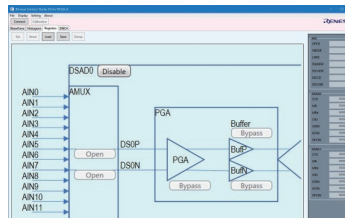

Parameter Settings on GUI

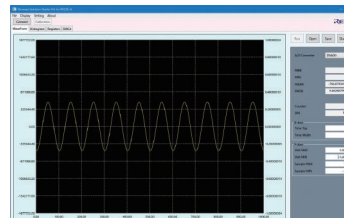

A/D Conversion Display on GUI

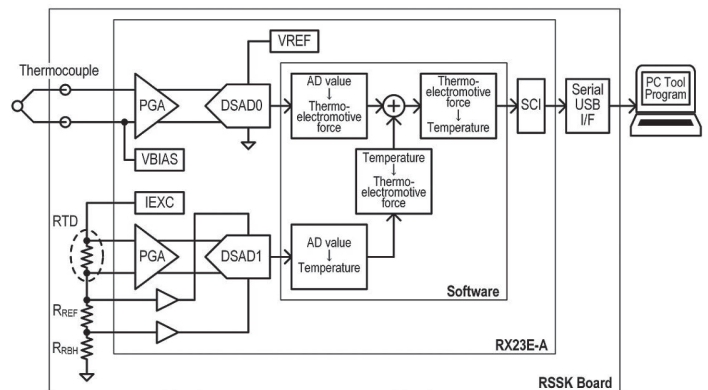

Block Diagram of Thermocouple Evaluation

Sensor Signal Conditioning ICs for Industrial Sensing Applications

Product Family Overview

Renesas Sensor Signal Conditioner (SSC) ICs facilitate design and production of sensor interfaces by providing programmable, highly accurate, wide gain and quantization functions combined with powerful, proven high-order digital correction and linearization algorithms, which are embedded in the device.

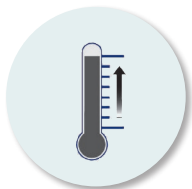

SENSOR SIGNAL

- Physical measure
 - Pressure
 - Torque
 - Temperature
 - Force
 - Weight/load

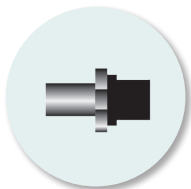

SIGNAL CONDITIONING

- Signal transducing
- Signal amplification
- Signal conditioning (compensation of offset, non-linearity and temperature dependency)

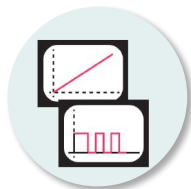

CONDITIONED OUTPUT

- Linear analog ratiometric voltage, current loop
- Digital PWM, I²C, SPI and OWI output

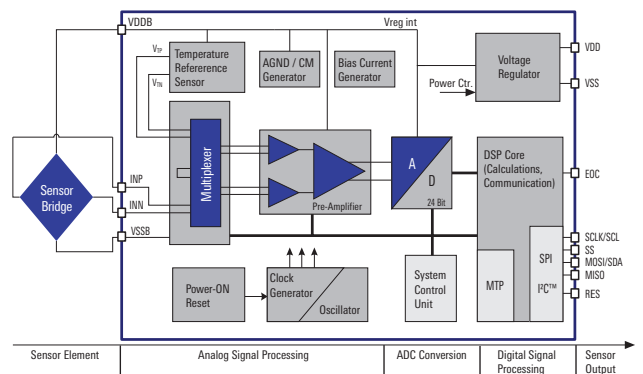

Typical SSC Block Diagram

See Product Portfolio on page 37.

Renesas Industrial Network Solution Contribute to Realize Smart Society

There are various protocols for industrial network and there are made the best use of various features. However, coexist of various protocols is the challenge for realizing smart society that require interoperability. Renesas has various product/solution and overcomes challenges with customer.

Various products to solve any industrial protocols

Renesas can provide one protocol communication IC and multi protocols communication IC.

One protocol communication IC give benefits as small footprint and low cost for customer.

Multi protocol communication IC give benefits as unique environment for customer.

Usable for any layers/use cases in industrial

Renesas industrial ethernet IC can realize standard ethernet products by customer.

Further, Renesas industrial ethernet IC supports redundancy network (HSR, PRP, DSR, MRP and so on). Furthermore, Renesas industrial ethernet IC can use expanded communication IC for MCU/MPU. So, Renesas IC can solve/use any layer communication.

Contribute to realize the interoperability for smart society

Some multi protocols communication IC can realize simultaneous operation for two industrial protocols. So, customer can develop the gateway between industrial ethernet protocols.

Industrial Network

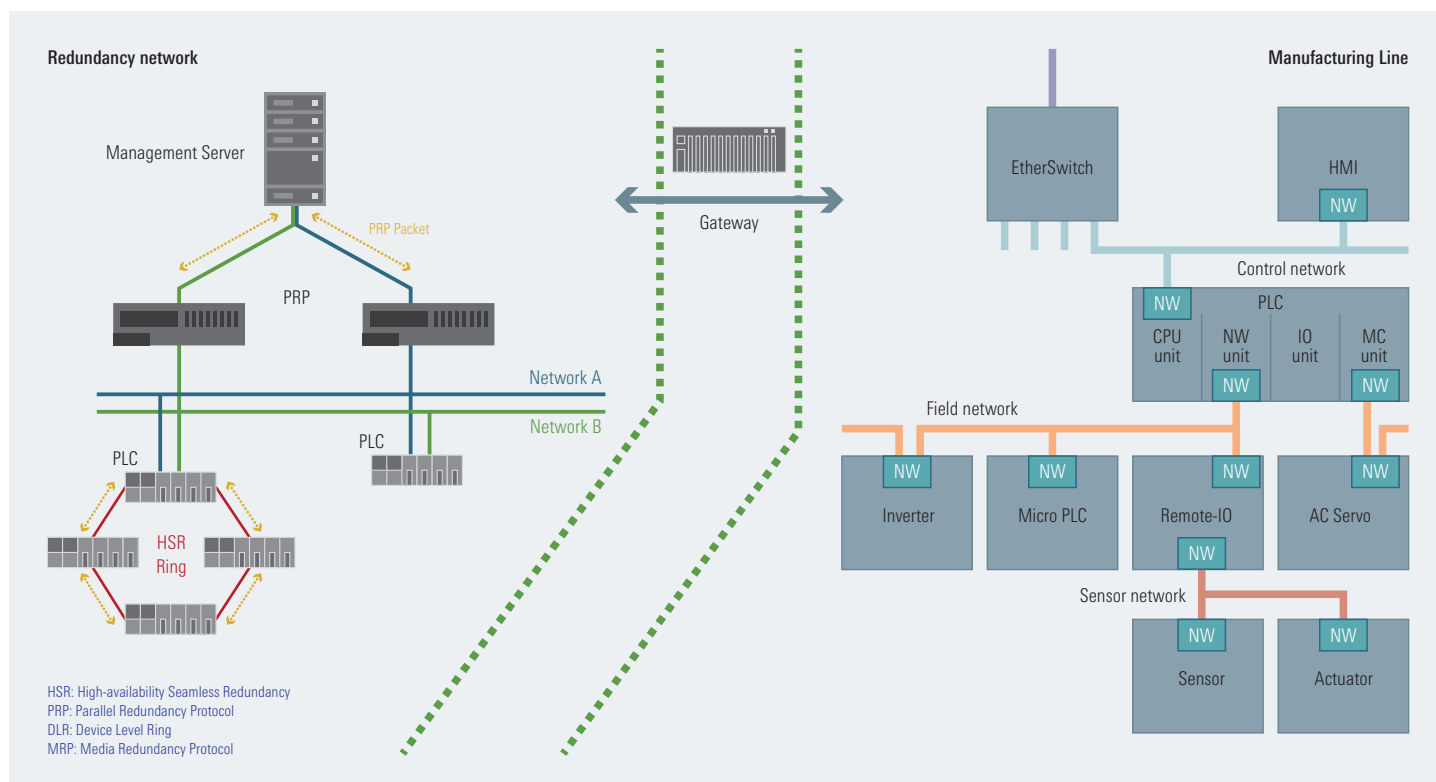

Recommended Devices for Industrial Networks

For Master

Fieldbus		RX72M	RZ/N1D	RZ/N1S	RZ/N1L	RZ/T1	ASI4U-V5
Industrial Ethernet	OPC UA	—	✓	—	—	—	—
	PROFINET	—	✓	—	—	—	—
	EtherCAT	—	✓	—	—	✓	—
	EtherNet/IP	—	✓	—	—	—	—
	POWERLINK	—	—	—	—	—	—
	ModbusTCP	✓	✓	—	—	—	—
	Sercos III	—	—	—	—	—	—
	CC-Link IE TSN	—	—	—	—	—	—
CC-Link IE Field	—	—	—	—	—	—	
Fieldbus	IO-Link	—	✓*	✓*	—	—	—
	PROFIBUS	✓	—	—	—	—	—
	CANopen	✓	✓	—	—	—	—
	DeviceNet	—	—	—	—	—	—
	Modbus RTU/ASCII	✓	✓	—	—	—	—
	CC-Link	—	—	—	—	—	—
	ASI-5	—	—	—	—	—	✓

For Slave

Fieldbus		RX72M	RZ/N1D	RZ/N1S	RZ/N1L	RZ/T1	R-IN32(CL3)	R-IN32(CL)	R-IN32(EC)	EC-1	TPS-1	ASI4U-V5	RL78
Industrial Ethernet	OPC UA	✓	✓	✓	✓	✓	✓*	✓	✓	—	—	—	—
	PROFINET	✓ RT	✓ RT	✓ RT	✓ RT	✓ RT	✓ RT	✓ RT	✓ RT	—	✓ RT, IRT	—	—
	EtherCAT	✓	✓	✓	✓	✓	—	—	✓	✓	—	—	—
	EtherNet/IP	✓	✓	✓	✓	✓	✓	✓	✓	—	—	—	—
	POWERLINK	—	✓	✓	✓	—	—	—	—	—	—	—	—
	ModbusTCP	✓	✓	✓	✓	✓	✓	✓	✓	—	—	—	—
	Sercos III	—	✓	✓	✓	—	—	—	—	—	—	—	—
	CC-Link IE TSN A: ClassA B: ClassB	✓ A	✓* A	✓* A	✓* A	✓* A	✓ A, B	✓ A	✓ A	—	—	—	—
CC-Link IE F: Field FB: Field Basic	✓* FB	✓* FB	✓* FB	✓* FB	✓* FB	✓ F ✓* FB	✓ F ✓* FB	—	—	—	—	—	
Fieldbus	IO-Link	—	—	—	—	—	—	—	—	—	—	—	✓
	PROFIBUS	✓	—	—	—	✓*	—	—	—	—	—	—	—
	CANopen	✓	—	—	—	✓*	—	—	—	—	—	—	—
	DeviceNet	✓	—	—	—	✓*	—	—	✓	—	—	—	—
	Modbus RTU/ASCII	✓	✓	✓	✓	✓	✓	✓	✓	—	—	—	✓
	CC-Link	—	—	—	—	—	—	✓	✓	—	—	—	—
ASI-5	—	—	—	—	—	—	—	—	—	—	—	✓	

Note: Under consideration. Contact a sales person for details.

AC Servo System Configuration and Our Recommendation

Overview

- The AC servo system used in machine tools, industrial robots, and variety of other manufacturing machinery precisely controls the rotor position, rotation direction, rotation speed, and torque of servo motors. Features such as fast calculation, the ability to generate and output multiple waveforms, and feedback control are necessary to achieve fast response to changes in load, improved stopping accuracy, and minimal vibration. Also requires communication functions (industrial network support) for advanced motion control instructions, remote operation, and synchronous processing.
- To meet these needs, Renesas offers an extensive product lineup. The RZ/T1 is a microprocessor that is ideal for AC servo control applications, combining fast real-time processing performance with extensive peripheral functions such as multifunction motor control timer, A/D converter, encoder interface, and R-IN Engine. Also with the RX Family, which comprises a wide range of product series, and an array of analog and power devices.

System Block Diagram

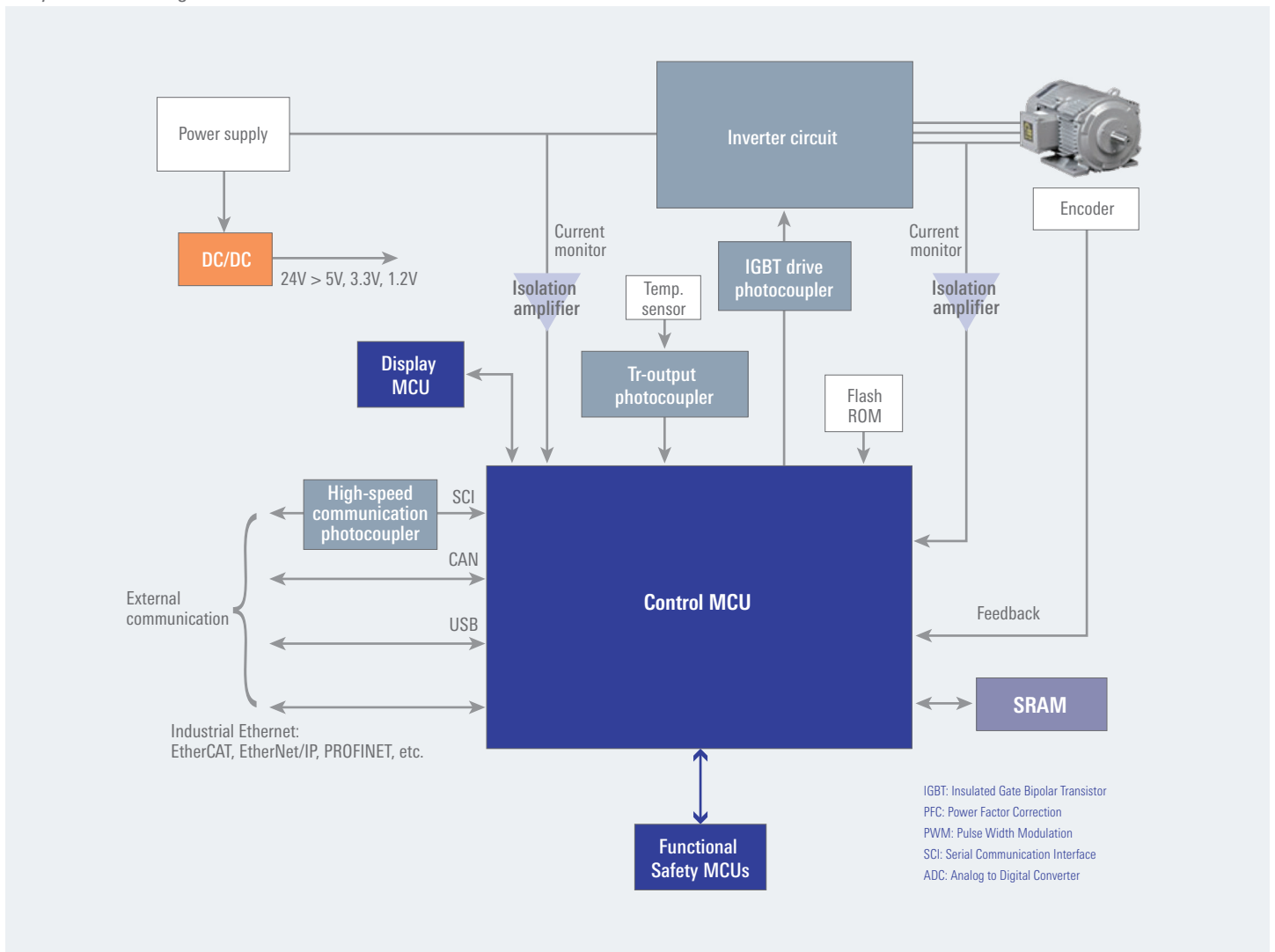

Recommended Products

Microcontrollers and Microprocessors

Block	Recommended Products	Operating Frequency (MHz)	Operating Voltage (V)	On-Chip Memory (Max.)	Features, etc.
Control MCU	RZ/T1	600/450/300	3.3 (I/O) 1.2 (Core)	Tightly-coupled memory 512KB + 32KB Extended RAM: 1MB	<ul style="list-style-type: none"> Tightly-coupled memory for fast real-time control R-IN Engine for fast, power-efficient communication Encoder interface to accommodate external FPGA functions
	RX72M NEW	240	2.7 to 3.6	4MB Flash 1MB RAM 32KB DataFlash	<ul style="list-style-type: none"> High-performance RXv3 core and large memory capacity for high-precision motor control Arithmetic unit for trigonometric functions and collective register bank save function On-chip EtherCAT slave controller
	RX72N NEW	240	2.7 to 3.6	4MB Flash 1MB RAM 32KB DataFlash	<ul style="list-style-type: none"> High-performance RXv3 core and large memory capacity for high-precision motor control Arithmetic unit for trigonometric functions and collective register bank save function 2ch Ethernet
	RX72T NEW	200	2.7 to 5.5	1MB Flash 128KB RAM 32KB DataFlash	<ul style="list-style-type: none"> High performance RXv3 core with various motor control function Large memory helps the complicated software development Enable the secure data/communication with the built-in hardware encrypt engine
	RX66T	160	2.7 to 5.5	1MB Flash 128KB RAM 32KB DataFlash	<ul style="list-style-type: none"> Arithmetic unit for trigonometric functions to speed up operations such as coordinate conversion, position control, and phase calculation (RX72T) High-resolution PWM enabling PWM waveform adjustment down to 195ps (RX66T)
	RA6T1 NEW	120	2.7 to 3.6	512KB Flash 64KB RAM 8KB Data Flash	<ul style="list-style-type: none"> Arm®Cortex®-M4 Core and offer various motor control function. Flexible Software Package (FSP) including motor control specific control software enable easy application design and quick time to the market.
Display MCU	RX651 RX65N	120	3.3	1MB Flash 256KB RAM	<ul style="list-style-type: none"> To provide high performance and low power consumption. To enhance Connectivity and Encryption functions, it is possible to be delivered in various needs.
	RX113	32	3.3	512KB Flash 64KB RAM 8KB Data Flash	<ul style="list-style-type: none"> Ability to implement a variety of user interfaces using capacitive touch sensing and segment LCD controller
	RA6M3 NEW	120	3.3	2MB Flash 640KB RAM	<ul style="list-style-type: none"> Arm® Cortex®-M4 core and offers a TFT controller with 2D accelerator and JPEG decoder. Flexible Software Package (FSP), built on FreeRTOS and is expandable to use other RTOSes and middleware.
	RA6M4 NEW	200	3.3	1MB Flash 256KB RAM	<ul style="list-style-type: none"> Arm® Cortex®-M33 with Capacitive touch sensing unit. Flexible Software Package (FSP), built on FreeRTOS and is expandable to use other RTOSes and middleware.

Memory

Block	Memory Density	Recommended Products	Access Time (Max.)	Standby Current (Typ.)	Features, etc.
SRAM	4-Mbit	RMLV0408E Series RMLV0414E Series RMLV0416E Series	45ns	0.4µA	Competitive differentiation: <ul style="list-style-type: none"> Industry-leading Low standby current, suitable for battery-backup memory High reliability: Extremely low soft-error rate, ~ less than 0.1 FIT / Mbit
	8-Mbit	RMLV0808B Series RMLV0816B Series	45ns	0.45µA	
	16-Mbit	RMLV1616A Series	55ns	0.5µA	
	32-Mbit	RMLV3216A Series	55ns	0.6µA	
	32-Mbit	RMWV3216A Series (2-chip MCP)	55ns	1.0µA	
	64-Mbit	RMWV6416A Series (2-chip MCP)	55ns	1.2µA	

Analog and Power Devices

Block	Category	Recommended Products	Main Specifications	Features, etc.
Power supply	DC/DC	RAA230152	Input voltage range: 7 to 28V Output voltage: 5.0V Max. output current: 3A	<ul style="list-style-type: none"> Auto PFM (low-load, low power operation) mode
		RAA230153	Input voltage range: 7 to 28V Output voltage: 0.8 to 6V Max. output current: 3A	
		RAA230231	Input voltage range: 4.5 to 16V Output voltage: CH1 3.3V, CH2 0.8 to 6V Max. output current: 3A	<ul style="list-style-type: none"> Auto PFM (low-load, low power operation) mode Dual channel DC/DC
		RAA212422	Dual synchronous rectification DC/DC regulator <ul style="list-style-type: none"> CH1: Vin = 3 to 40V, 1.1A output CH2: Vin = 2.7 to 5.5V, 1.5A 	<ul style="list-style-type: none"> Low-load mode Compact package: 3mm × 6mm TDFN
Current monitor	Isolation amplifier	PS8352A PS9352A	1% precision, analog output, SDIP package 1% precision, digital output, SDIP package	<ul style="list-style-type: none"> Support for high temperature operation up to 110°C
Inverter circuit	IGBT/PM drive photocoupler	PS9402/PS9031 PS9009/PS9905	IGBT protection circuit/2.5A output small package IPM drive/690V insulation	<ul style="list-style-type: none"> Ability to select from wide range of functions to match IGBTs used
Isolation	High-speed communication photocoupler Tr-output photocoupler	PS9001	10Mbps, compact, high voltage tolerance	<ul style="list-style-type: none"> Compact and high voltage tolerance
		PS8902/PS9924	690V insulation	
		PS2381	Compact, high temperature tolerance	

Four Features of the RZ/T Series

High-Performance, High-Speed Real-Time Control

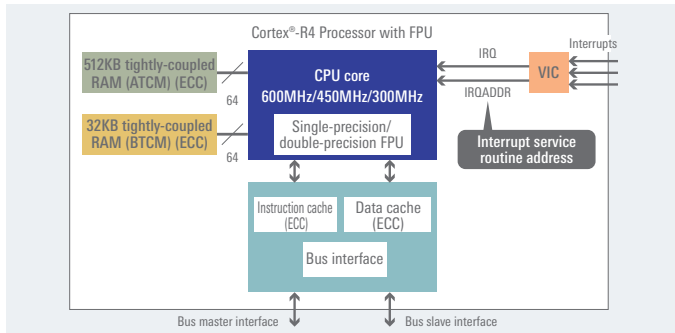

- High-speed RAM connected directly to the CPU for fast processing and deterministic real-time responsiveness without the cache
- ECC for enhanced reliability
- Vectored interrupt controller (VIC) to ensure interrupt responsiveness suitable for embedded control applications

Integrated Peripheral Functions

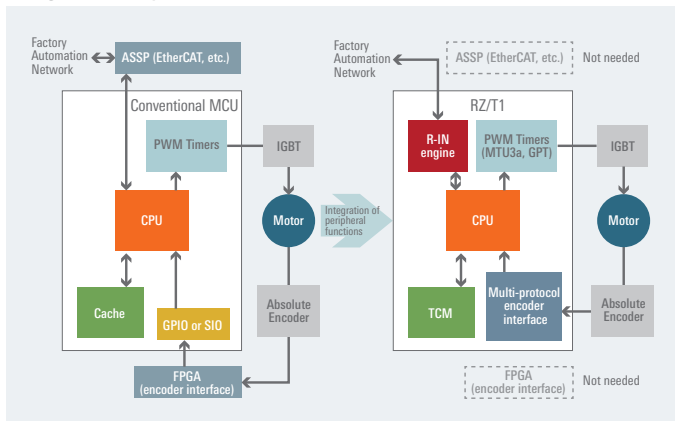

- The integrated encoder interface (option) handles the functions previously performed by external FPGA or ASIC devices.
- This one-chip AC servo solution reduces the component count and reduces the component count and board area.

Supports Encoder Protocol	
Nikon A-format™	
BiSS-C	
EnDat2.2	
Tamagawa	
HIPERFACE DSL	

* Visit the website for configuration data for each encoder interface is available.
<https://www.renesas.com/ja-jp/products/microcontrollers-microprocessors/rz/rzt/rzt1.html#sampleCodes>

On-Chip R-IN Engine

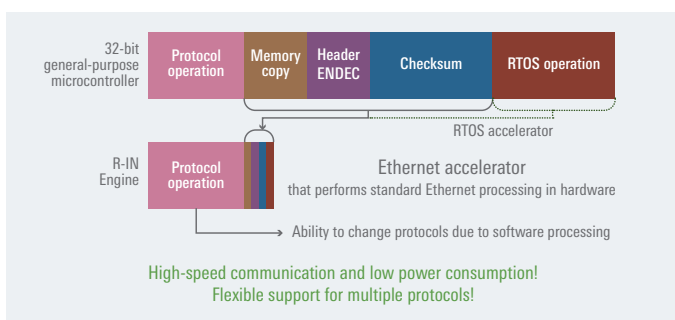

- The R-IN Engine accelerator for Industrial Ethernet communication performs standard Ethernet processing in hardware.
- Network processing four times as fast as comparable conventional products.

Supports Industry Ethernet Communication	Provides Solution, Supports Partners
EtherCAT 	Released Example program (https://www.renesas.com/ja-jp/products/microcontrollers-microprocessors/rz/rzt/rzt1.html#sampleCodes) acontis technologies Japan (EtherCAT Master) (http://www.acontis.com/int/jp/index.php) JSL Technology (EtherCAT Slave) (http://jst.co.jp/) Sherpa Inc. (EtherCAT Slave) (https://www.Sherpa-tech.net/) M2M craft Co., Ltd. (EtherCAT Slave) (http://www.m2mcraft.co.jp/)
PROFINET 	Sherpa Inc. (https://www.sherpa-tech.net/) M2M craft Co., Ltd. (http://www.m2mcraft.co.jp/) TMG Technologie und Engineering GmbH (https://www.tmgte.de/) port GmbH (http://www.port.de/) Molex LLC (https://www.molex.com/molex/home)
EtherNet/IP 	Sherpa Inc. (https://www.sherpa-tech.net/) M2M craft Co., Ltd. (http://www.m2mcraft.co.jp/) TMG Technologie und Engineering GmbH (https://www.tmgte.de/) port GmbH (http://www.port.de/) Molex LLC (https://www.molex.com/molex/home)
Modbus 	Released Example program (https://www.renesas.com/ja-jp/products/microcontrollers-microprocessors/rz/rzt/rzt1.html#sampleCodes)

RZ/T1 (Support Multi Protocol)

High performance CPU (Arm® Cortex®-R4 Processor with FPU)

- Operating frequency: 450MHz/600MHz
- High-performance, high-speed real-time control
- Single-precision/double-precision floating-point unit

On-chip memory

- Tightly Coupled Memory: 512KB (w/ ECC) + 32KB (w/ ECC)
- R-IN engine instruction memory: 512KB (w/ ECC) + data memory: 512KB (w/ECC)

Features

- Industrial Ethernet communication accelerator with multi-protocol support (R-IN engine)
- EtherCAT slave controller
- PWM timers: MTU3a, GPT
- Encoder interface (Nikon A-format™/BiSS-C/EnDat2.2/HIPERFACE DSL®/Tamagawa) (option)
Note: 2ch encoder support depends on the combination of the selected protocol
- High Speed USB
- Secure boot (option)
- Safety functions
 - ECC memory
 - CRC (32-bit)
 - Independent WDT: Operating on dedicated on-chip oscillator
- ΔΣ interface
- 100Mbps EtherMAC (with Ethernet switch)
- Ethernet accelerator
- Power supply voltage: 1.2V, 3.3V

Package

- FBGA 320pin (17mm × 17mm, 0.8mm pitch)

Photocouplers (Isolation Amplifiers, IGBT/IPM Drive Photocouplers, High Speed Photocouplers)

Renesas photocouplers are based on technology that provides three benefits: high reliability even at high temperatures, high noise tolerance, and high voltage tolerance in spite of small package size. The lineup of photocoupler products is available to meet the requirements of each specific application. Isolation amplifiers, IGBT/IPM drive photocoupler, and high-speed communication photocouplers can be used in combination to effectively isolate key portions of AC servo system.

- The isolation amplifier lineup includes products offering analog or digital output at 1% precision and a compact package (SDIP).
- The lineup of IGBT/IPM drive photocoupler includes products designed to accommodate 2.5A output.
 - Products with integrated Desat or active mirror clamp functionality to prevent IGBT destruction
 - Products with high voltage tolerance and a compact LS05 package
 - 14.5mm creepage products capable of accommodating 690V European industrial voltage

RZ/T1 Motion Control Solution Kit

<Features>

- Package includes all parts needed for motor control evaluation.
- Supports safe design and can be used for reference.
- Includes multifunction utility tool.
- Servo control software is available.

RZ/T1 (Support Multi Protocol) Block Diagram



Power ICs (DC/DC)

Feature 1. Bundled with microcontrollers to simplify the power supply design process.

Renesas offers kit products comprising microcontrollers and power ICs to simplify the task of designing a power supply and shorten TAT.

Feature 2. Ideal for systems incorporating RZ, R-IN, and SoC devices requiring multiple power supplies.

The ability to deliver multiple power supplies from a single power IC reduces the board size and component count.

Renesas solution boards help simplify the task of designing complex power supplies and shorten TAT.

Feature 3. Web-based simulation environment

This service calculates the circuit characteristics (power conversion efficiency, output ripple voltage, and discharge time) based on the operating conditions supplied by the customer and provide graphs that can be referenced when selecting circuit characteristics and components.



Illustration of kit

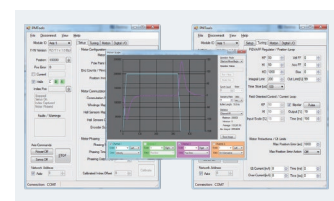

Tool screenshots

General Purpose Inverter System Configuration and Our Recommendation

Overview

- The general-purpose inverter is a variable-speed controller that precisely controls the shaft rotation speed, typically, an induction motor or synchronous motor. They are widely used in industrial machinery such as production line conveyors, cranes, elevators, fans, pumps, and compressors. As the need to save energy grows worldwide, there is widespread demand for an inverter control to boost energy efficiency. The performance and multifunctionality of inverters continue to improve. This is due to advances in simple controller functions, interfaces such as field networks of various types and USB, and display panels enhancing usability. At the same time, there is growing demand in emerging economies for inverters that are cheaper and more compact.
- In response to these varied requirements, Renesas offers a broad lineup of products that provide scalability. The RX Family provide an array of on-chip peripheral functions such as multifunction timers and A/D converters optimized for inverter control, Ethernet and USB interfaces, and serial interfaces. Also available with analog and power devices suitable for inverter applications.

System Block Diagram

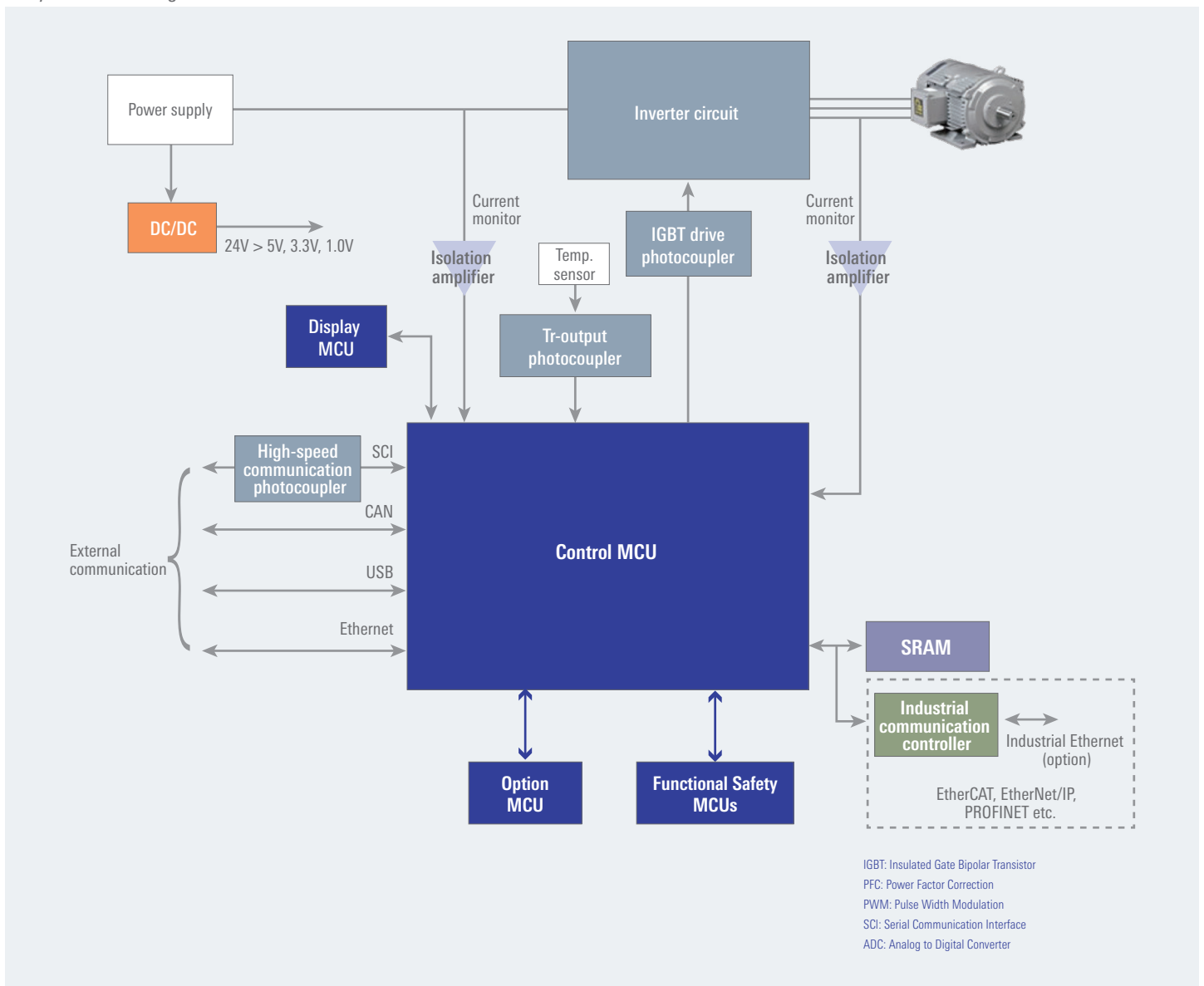

Recommended Products

Microcontrollers

Block	Recommended Products	Operating Frequency (MHz)	Operating Voltage (V)	On-Chip Memory (Max.)	Features, etc.
Control MCU	RX72M NEW	240	2.7 to 3.6	4MB Flash 1MB RAM 32KB DataFlash	<ul style="list-style-type: none"> High-performance RXv3 core and large memory capacity for high-precision motor control Arithmetic unit for trigonometric functions and collective register bank save function On-chip EtherCAT slave controller
	RX72N NEW	240	2.7 to 3.6	4MB Flash 1MB RAM 32KB DataFlash	<ul style="list-style-type: none"> High-performance RXv3 core and large memory capacity for high-precision motor control Arithmetic unit for trigonometric functions and collective register bank save function 2ch Ethernet
	RX72T NEW	200	2.7 to 5.5	1MB Flash 128KB RAM 32KB DataFlash	<ul style="list-style-type: none"> High performance RXv3 core with various motor control function Large memory helps the complicated software development Enable the secure data/communication with the built-in hardware encrypt engine
	RX66T	160	2.7 to 5.5	1MB Flash 128KB RAM 32KB DataFlash	<ul style="list-style-type: none"> Arithmetic unit for trigonometric functions to speed up operations such as coordinate conversion, position control, and phase calculation (RX72T) High-resolution PWM enabling PWM waveform adjustment down to 195ps (RX66T)
	RA6T1 NEW	120	2.7 to 3.6	512KB Flash 64KB RAM 8KB Data Flash	<ul style="list-style-type: none"> Arm®Cortex®-M4 Core and offer various motor control function. Flexible Software Package (FSP) including motor control specific control software enable easy application design and quick time to the market.
	RX24T RX24U	80	2.7 to 5.5	512KB Flash 32KB RAM 8KB DataFlash	<ul style="list-style-type: none"> Support for wide range of power supply voltages, all functions necessary for motor control on a single compact chip
Display/Option MCU	RX65N RX651	120	3.3	2MB Flash 640KB RAM	<ul style="list-style-type: none"> High performance and low power consumption. Enhanced connectivity and encryption feature to meet various needs.
	RX113	32	3.3	512KB Flash 64KB RAM 8KB DataFlash	<ul style="list-style-type: none"> Suitable for various user interfaces such as LCD, touch sensor, USB etc.
	RA6M3 NEW	120	3.3	2MB Flash 640KB RAM	<ul style="list-style-type: none"> Arm® Cortex®-M4 core and offers a TFT controller with 2D accelerator and JPEG decoder. Flexible Software Package (FSP), built on FreeRTOS—and is expandable to use other RTOSes and middleware.
	RA6M4 NEW	200	3.3	1MB Flash 256KB RAM	<ul style="list-style-type: none"> Arm® Cortex®-M33 with Capacitive touch sensing unit. Flexible Software Package (FSP), built on FreeRTOS and is expandable to use other RTOSes and middleware.

Industrial Communication Chip

Block	Category	Recommended Products	Features, etc.
Industrial communication controller	Multi protocol	R-IN32M3-CL/EC	<ul style="list-style-type: none"> Support CC-Link IE, EtherCAT, EtherNet/IP etc. with One chip.
		R-IN32M4-CL3	<ul style="list-style-type: none"> Support for multiple protocols, including CC-Link IE TSN, Ethernet/IP, and PROFINET Integrated 2-port gigabit Ethernet compatible PHY
		RZ/N1L	<ul style="list-style-type: none"> Easy slave implementation with R-IN engine and specific hardware
	Dedicated protocol	TPS-1	<ul style="list-style-type: none"> Best real time performance, fully meets PROFINET IRT standards.
		EC-1	<ul style="list-style-type: none"> Optimized for EtherCAT applications. Provide solutions with high reliability.

Memory

Block	Memory Density	Recommended Products	Access Time (Max.)	Standby Current (Typ.)	Features, etc.
SRAM	4-Mbit	RMLV0408E Series RMLV0414E Series RMLV0416E Series	45ns	0.4μA	Competitive differentiation: <ul style="list-style-type: none"> Industry-leading Low standby current, suitable for battery-backup memory High reliability: Extremely low soft-error rate, ~ less than 0.1 FIT / Mbit
	8-Mbit	RMLV0808B Series RMLV0816B Series	45ns	0.45μA	
	16-Mbit	RMLV1616A Series	55ns	0.5μA	
	32-Mbit	RMLV3216A Series	55ns	0.6μA	
	32-Mbit	RMWV3216A Series (2-chip MCP)	55ns	1.0μA	
	64-Mbit	RMWV6416A Series (2-chip MCP)	55ns	1.2μA	

Analog and Power Devices

Block	Category	Recommended Products	Main Specifications	Features, etc.
Power supply	DC/DC	RAA230152	Input voltage range: 7 to 28V, Output voltage: 5.0V Max. output current: 3A	<ul style="list-style-type: none"> Auto PFM (low-load, low power operation) mode
		RAA230153	Input voltage range: 7 to 28V, Output voltage: 0.8 to 6V Max. output current: 3A	
		RAA230231	Input voltage range: 4.5 to 16V Output voltage: CH1 3.3V, CH2 0.8 to 6V Max. output current: 3A	<ul style="list-style-type: none"> Auto PFM (low-load, low power operation) mode Dual channel DC/DC
		RAA212422	Dual synchronous rectification DC/DC regulator <ul style="list-style-type: none"> CH1: Vin = 3 to 40V, 1.1A output CH2: Vin = 2.7 to 5.5V, 1.5A 	<ul style="list-style-type: none"> Low-load mode Compact package: 3mm × 6mm TDFN
		ISL80019	Synchronous rectification regulator Vin = 2.7 to 5.5V, 1.5A	<ul style="list-style-type: none"> Low-load mode Compact package: 2mm × 2mm TDFN
Current monitor	Isolation amplifier	PS8352A PS9352A	1% precision, analog output, SDIP package 1% precision, digital output, SDIP package	<ul style="list-style-type: none"> Support for high temperature operation up to 110°C
Inverter circuit	IGBT/IPM drive photocoupler	PS9402/PS9031 PS9009/PS9905	IGBT protection circuit/2.5A output small package IPM drive/690V insulation	<ul style="list-style-type: none"> Ability to select from wide range of functions to match IGBTs used
Isolation	High-speed communication photocoupler Tr-output photocoupler	PS9001	10Mbps, compact, high voltage tolerance	<ul style="list-style-type: none"> Compact and high voltage tolerance
		PS8902/PS9924	690V insulation	
		PS2381	Compact, high temperature tolerance	

Our Recommended Solutions for General Purpose Inverters

Recommended MCUs for Motor Application

Motor Type	Control Method	Necessary Functions	Performance Required by Application and Recommended MCUs				
			Up to 32MHz	Up to 40MHz	Up to 120MHz	Over 120MHz	
			RX13T RL78/G1F	RX23T	RX66T/RX24T/RX24U RA6T1	RX72M/RX72T/RX66T RA6T1	
Brushless DC Motor	Vector control (120-degree continuity control)	PWM x6 Dead time generator POE A/D converter (PWM link)	Compact motors	Compact Robot Surveillance cameras General purpose inverters Printers / Multi-function printers	Washing machine (1 Motor) Refrigerator (1 Motor) Pump Compressor	Air conditioner (2 Motor) Washing machine (2 Motor)	General purpose inverters Machine tools Industrial Robot AC Servo
	Square wave control (120-degree continuity control)	PWM x6 A/D converter	Fan Drone	Refrigerator Fan Compact Robot	Refrigerator Pump Compressor		
Induction AC Motor	Vector control	PWM x6 Dead time generator POE A/D converter (PWM link)		Industrial Pump	General purpose inverters (Fan, Pump)		
	V/f control	PWM x6 Dead time generator POE A/D converter (PWM link)	Fan Refrigerator Washing machine Pump	Air conditioner Pump	General purpose inverters (Fan, Pump)		
Stepper Motor	Vector control	PWM control	Printers / Multi-function printers / Surveillance cameras / Compact motors		Industrial motors	Machine tools Compact industrial robots	
	Pulse output	Port control or PWM control	Printers / Multi-function printers / Surveillance cameras		Industrial motors		

Renesas Motor Control Evaluation Solution

Renesas provides various motor control solutions, including hardware supports such as motor control evaluation system, starter's kits, as well as software tools such as vector control and other control methods, waveform display, automatic parameter adjustments etc.

Renesas Motor Control Evaluation Kit (Renesas Solution Starter Kit)
Just connect a power supply to get started checking your motor drive application.

This kit consists of a motor and an inverter board.*

After purchase, you can download the software from the website and start evaluating immediately.

Motor Control Development Support Tool Renesas Motor Workbench

Analyzer function reduces the debugging workload. Tuner function enables simple vector control, even if you have no specialized knowledge.



Motor Control Evaluation System for RA Family -RA6T1 Group

Evaluation System for BLDC Motor *2

Evaluation System for Stepping Motor with Resolver

RZ/T1 Motion Control Solution Kit

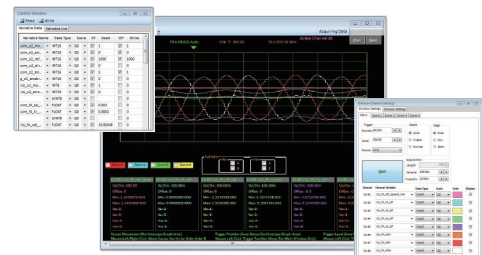

*1 Renesas Motor evaluation systems do not include the emulator or a power supply. These must be obtained.

*2 Evaluation System for BLDC Motor does not include a CPU card. Please purchase the desired CPU card before use.

Application Notes/Sample Code

Renesas provides ready to use sample codes and application notes for each type of motor control.

Control method	Target MCU	Status
120-degree conducting control with hall sensor	RX23T, RX24T	Available (by website)
Sensorless 120-degree conducting control	RX23T, RX24T, RL78/G1F	Available (by website)
Vector control with encoder	RX72T, RX66T, RX24T, RX24U, RX23T	Available (by website)
Sensorless vector control	RX72T, RX66T, RX24T, RX24U, RX23T, RX13T, RL78/G1F	Available (by website)
Induction AC motor sensorless vector control	RX66T, RX13T (*uses partner inverter board)	Available (by website)
Resolver vector control	RX72M, RX66T, RX24T, RX23T	Available (by website)

Recommended RX MCUs for General Purpose Inverters

RX72M Group

Built around the RXv3, the third-generation RX CPU core, these high-performance MCUs (1396 coremark score) provide functions needed for the main applications for industrial machinery and EtherCAT communication functionality on an one-chip.

RX72M Group Block Diagram



RX66T Group

The RXv3 core offers the best performance at the same range MCU with 5V support. And the built-in motor control peripherals (pseudo-differential input PGA, comparator, etc.) contributes to BOM reduction. Feature hardware implementation of system safety functions, greatly reducing the load imposed by software.

RX66T Group Block Diagram



RX72T Group

RX72T Group offers high performance required for motor control in robots and other equipment by max 200 MHz operating frequency CPU core and dedicated accelerators. Built-in security and safety features also offer new added value for inverter control applications.

RX72T Group Block Diagram

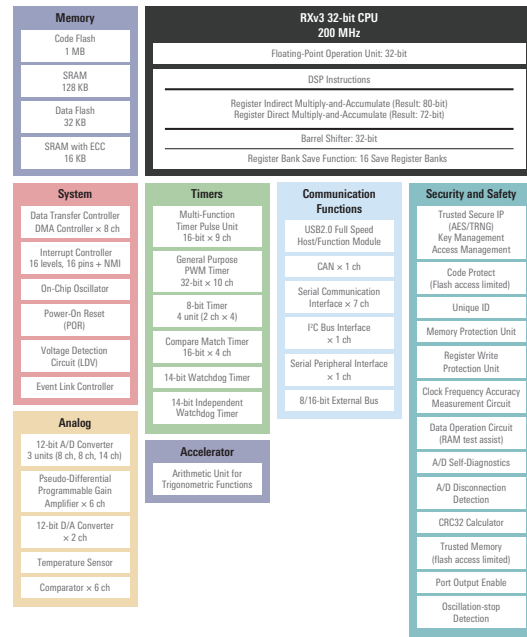

RX24T Group

RX24T MCU are designed to ensure the highest noise immunity and operate in a voltage range from 2.7V to 5.5V and added operating ambient temperature 105 degree product line up, providing the highest reliability for any equipment using inverter.

RX24T Group Block Diagram



PLC System Configuration and Our Recommendation

Overview

- Programmable logic controllers (PLCs) are used to control industrial machinery such as AC servos, general-purpose inverters, and sensors. They are widely used in factory automation systems for manufacturing and processing lines, machine tools, and industrial robots. To provide control capabilities tailored to each individual system, modular PLCs (CPU unit and various peripheral units) are used for large-scale and midsize systems, while block PLCs (CPU unit only) are used for small-scale systems.
- Peripheral units of module type PLC includes a variety of products to match the specific requirements from end users, while the proliferation of development resources has become an issue. To solve this problem, Renesas offers a peripheral unit platform based on the RX Family, which covers a broad performance range (32MHz to 240MHz) and a multitude of peripheral functions. This helps reduce the amount of development resources needed.
- For block type PLC, RX family provides a one chip solution with large capacity RAM, Ethernet, USB, SDCard I/O integrated, leading to both performance rise and BOM size reduction. RX700/RX600 series can provide an even larger selection of products, for our customers to expand their own series of products.
- Furthermore, if RX family haven't met the performance requirements, please consider as well our RZ/A and RZ/N series, both offer higher RAM capacity. By utilizing the extra large RAM, the memory access speed can be improved, which, in turn, leads to higher performance of the customer products.

System Block Diagram

Module type PLC: CPU unit + peripheral units

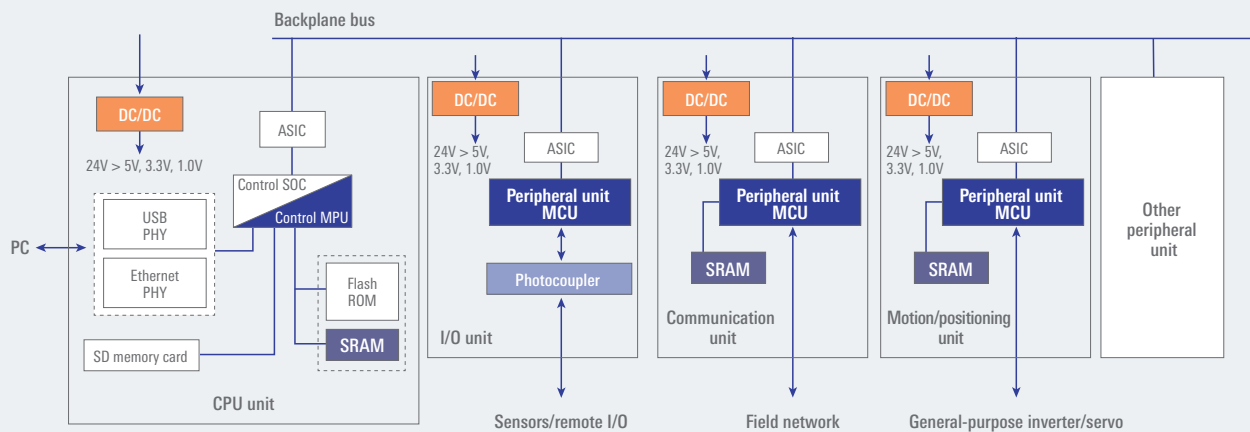

Block type PLC

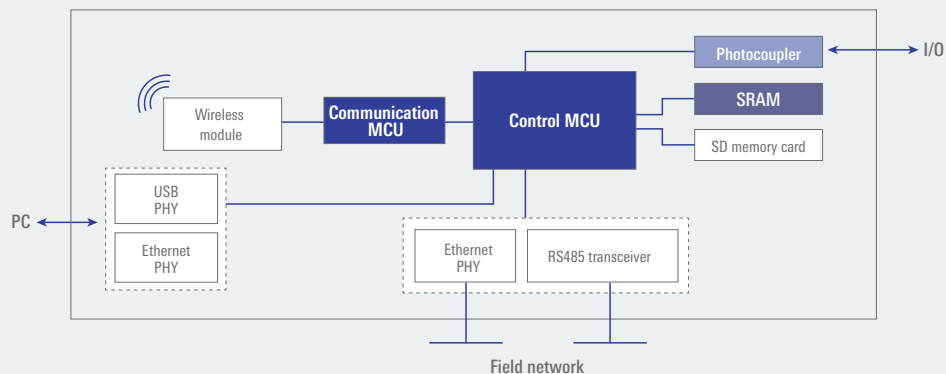

Recommended Products

Microcontrollers and Microprocessors

Block	Recommended Products	Maximum Operating Frequency	On-Chip Memory (Max.)	Features, etc.
MCU for peripheral units or Control MCU/Control MPU	RZ/A1	400MHz	2 to 10 MB RAM	Using the internal RAM, memory access is significantly faster and more stable compared to that of using external RAM. Furthermore, in case an one-chip solution is desired to handle both lag processes and network processes simultaneously, as well as provide support to multiple industrial network master protocols, our RX/N1D is the right product for you.
	RZ/A2M	528MHz	4MB RAM	
	RZN1S	500MHz	6MB RAM	
	RZN1D	500MHz Dual	2MB (+DDR-IF)	
	RX72M	NEW 240MHz	4MB Flash 1MB RAM 32KB DataFlash	<ul style="list-style-type: none"> High-performance RXv3 core and large memory capacity for high-precision motor control Arithmetic unit for trigonometric functions and collective register bank save function 2ch Ethernet
	RX72N	NEW 240MHz	4MB Flash 1MB RAM 32KB DataFlash	
	RX65N RX651	120MHz	2MB Flash 640KB RAM	
	RA6M3	NEW 120MHz	2MB Flash 640KB RAM	Peripheral unit microcontroller: Module type PLC <ul style="list-style-type: none"> Creating an RX-based platform for many types of peripheral units helps reduce the development resources (time and cost) required.
	RA6M4	NEW 200MHz	1MB Flash 256KB RAM	Control microcontroller: Block type PLC <ul style="list-style-type: none"> In addition to communication functions such as Ethernet and USB, the large memory capacity helps reduce the number of external components required.
	Peripheral unit MCU or Communication MCU	RX231	54MHz	512KB Flash 64KB RAM 8KB DataFlash
Peripheral unit MCU	RX111	32MHz	512KB Flash 64KB RAM 8KB DataFlash	<ul style="list-style-type: none"> Arm® core, security, and TrustZone (RA6M4). Flexible Software Package (FSP), built on FreeRTOS and is expandable to use other RTOSes and middleware.

Memory

Block	Memory Size	Recommended Products	Access Time (Max.)	Standby Current (Typ.)	Features, etc.
SRAM	4-Mbit	RMLV0408E Series RMLV0416E Series	45ns	0.4µA	<ul style="list-style-type: none"> Exclusive Renesas memory cell technology is more than 500 times as resistant to software errors as full CMOS memory cells, providing the extremely high reliability demanded in the industrial field.
	8-Mbit	RMLV0808B Series RMLV0816B Series			
	16-Mbit	RMLV1616A Series	55ns	0.5µA	
	32-Mbit	RMWV3216A Series		1.0µA	

Analog and Power Devices

Block	Category	Recommended Products	Main Specifications	Features, etc.
Power supply	DC/DC	RAA230152	Input voltage range: 7 to 28V Output voltage: 5.0V Max. output current: 3A	<ul style="list-style-type: none"> Auto PFM (low-load, low power operation) mode
		RAA230153	Input voltage range: 7 to 28V Output voltage: 0.8 to 6V Max. output current: 3A	
		RAA230231	Input voltage range: 4.5 to 16V Output voltage: CH1 3.3V, CH2 0.8 to 6V Max. output current: 3A	<ul style="list-style-type: none"> Auto PFM (low-load, low power operation) mode Dual channel DC/DC
		RAA212422	Dual synchronous rectification DC/DC regulator <ul style="list-style-type: none"> CH1: Vin = 3 to 40V, 1.1A output CH2: Vin = 2.7 to 5.5V, 1.5A 	<ul style="list-style-type: none"> Low-load mode Compact package: 3mm × 6mm TDFN
		ISL80019	Synchronous rectification regulator Vin = 2.7 to 5.5V, 1.5A	<ul style="list-style-type: none"> Low-load mode Compact package: 2mm × 2mm TDFN
Isolation	High-speed communication photocoupler Tr-output photocoupler	PS9001 PS9123, PS9124 PS284x-4	10Mbps, compact, high voltage tolerance Compact S05 package Common-lead package	<ul style="list-style-type: none"> Compact and high voltage tolerance, ideal for compact systems

Our Recommended Devices for PLCs

Peripheral Unit Platform Based on RX Family

1. Reducing development resources by adopting this platform

The module type of PLC consist with peripheral units such as IO Unit, Network Unit, and Positioning Units where MCU performance differs within each units. When choosing the microcontroller for each peripheral unit, selecting products with different CPU architectures, peripheral functions, or development environments can make it difficult to reuse existing software and increase the development resources (development time and cost). As a solution, Renesas offers a unified platform based on the RX Family microcontrollers, which cover a wide performance range from 32MHz to 240MHz. This RX-based platform allows "reuse of software assets" together with "unified development environment," in order to reduce development resources and bring added value to user applications.

Along with the reduction of required development resources, thanks to our RX platform, we are now preparing Firmware Integration Technology (FIT) to further support our customers to make up for the resource gap. FIT commonizes the configurations such as microcontroller initialization, file structure etc. of all sample codes for our RX family, making it easy to build the sample codes into the user application, since all the interfaces are also commonized, moving user applications among different RX-series microcontrollers is also stress-free, which in turn reduces the required development resources for our customers.

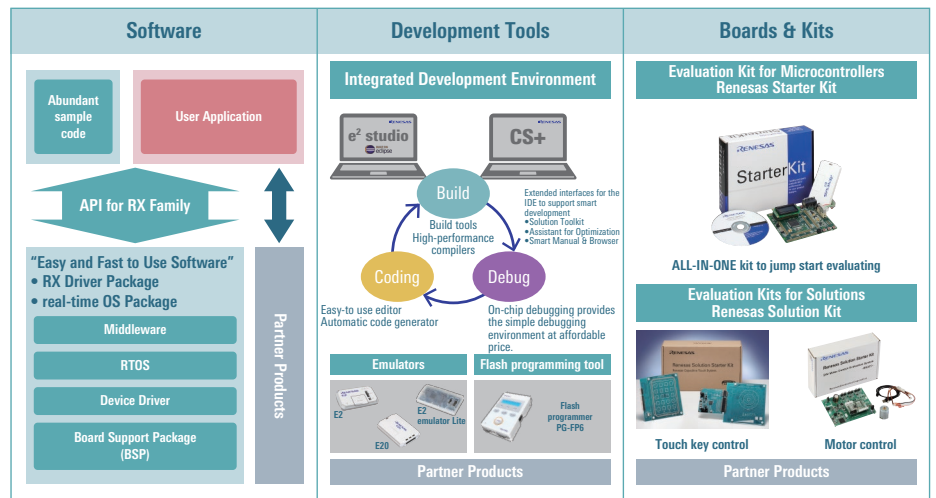

2. Adding New Products RX72M/72N: Reduce Development Work Labor when Expanding Product Series

The newly added RX72M/RX72N are successor of RX71M with enhanced performance and function as flagship of RX family, which makes design upgrade/migration quite easy.

In addition, we offer our customers great support such as FIT, specification-diff APN and Pin comparison documents.

High Performance

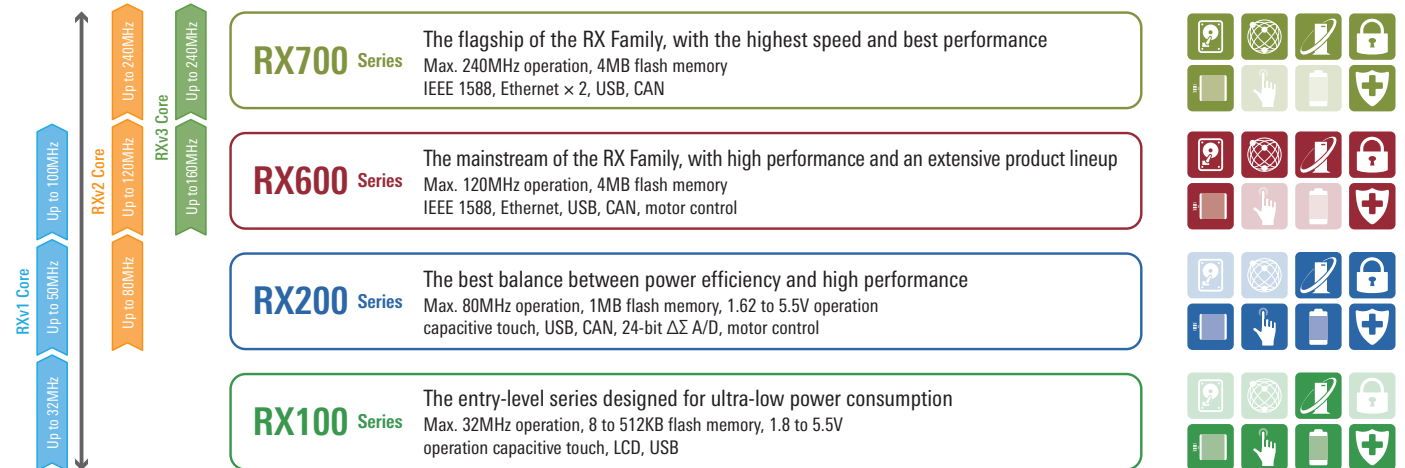

Low Power



■ A Proposal for Units Demanding Large RAM Capacity

By storing peripheral data in internal RAM instead of external RAM, the data access speed can be dramatically increased, which, in turn, improves the performance of the customer system.

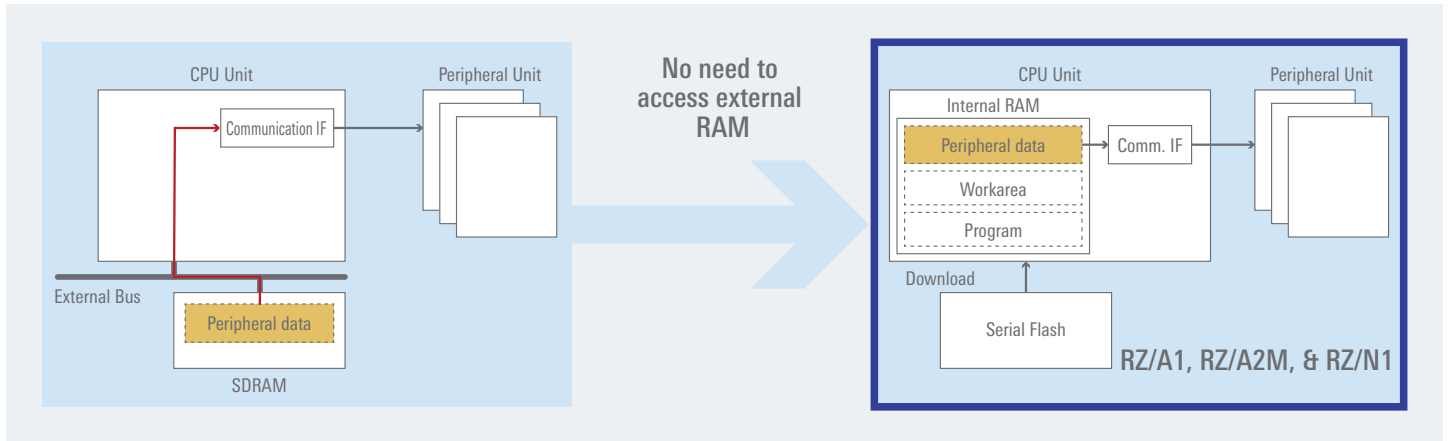

RZ/A1, RZ/A2M, and RZ/N1 are released with rich line-ups of internal RAM size, CPU performance etc., offering our customer the best chance of finding the optimized one for their own product series.

Series	CPU Core	CPU Freq. (MHz)	Internal RAM (MB)
RZ/A1	Cortex®-A9	400	2 to 10MB
RZ/A2M		528	4MB
RZ/N1S	Cortex®-A7	500	6MB
RZ/N1D	Cortex®-A7 Dual	500/500	2MB + (DDR IF)

■ Network Process and Ladder Process within the One-chip

RZ/N1D provides high CPU frequency, large sized memory I/F, USB, SDIOs, to interface with PLC. Also Renesas provides not only an IC but evaluation model SW PLC kit supporting PROFINET, EtherNet/IP, EtherCAT, etc. This will shrink your development timeline for immediate evaluation of industrial Ethernet master communication processing and ladder process.



General Feature

- U-boot
- Drivers
- C2C (Core to Core communication), etc.

Operating System

- Linux
- ThreadX

Evaluation version Protocol Stack Master

- Software PLC
- PROFINET
- EtherNet/IP
- EtherCAT, etc.

Slave

- PROFINET
- EtherNet/IP DLR
- EtherCAT, etc.

RZ/N1D Block Diagram

System 2 × 16ch DMAC JTAG w/disable function (Security Option) CGC	Package 400-pin LFBGA 17mm × 17mm/0.8mm pitch 324-pin LFBGA 15mm × 15mm/0.8mm pitch	Interfaces 8 × UART 2 × I ² C 2 × CAN 6 × SPI 2 × USB2.0 HS (Host/Func) Parallel Bus I/F (up to 32b bus)
Timers 6 × 16-bit GPT 2 × 32-bit GPT × 2 1 × WDT per CPU RTC	CPU Arm® Cortex®-A7 Core Processor @ 500MHz Arm® Cortex®-A7 Processor @ 500MHz MPU MMU Debug GIC MMU MPU FPU	Memory Interfaces Quad SPI with XiP NAND Flash I/F DDR2/DDR3 I/F 2 × SDIO/eMMC
Display LCD Controller	Memory L1 Cache I-Cache 16KB D-Cache 16KB L1 Cache I-Cache 16KB D-Cache 16KB L2 Cache 256KB SRAM 2MB (with ECC)	Analog 12-bit ADC @ 1MHz Up to 2unit × 8 channels
Security (option) Secure boot	R-IN Engine CPU Arm® Cortex®-M3 125MHz MPU Debug NVIC HW-RTOS Accelerator Ethernet Accelerator	
	Ethernet EtherCAT Slave Controller Sercos III Slave Controller 10/100/100 Ether Switch (4port + 1port) (IEEE1588, QoS, Aging, EEE, Snooping, DLR, TDMA, Storm protection cut-through, Jumbo frames) 2 × independent GMAC Hardware Redundancy (HSR) Controller	

*For full version protocol stack, please contact your nearest stack supplier

Remote IO System Configuration and Our Recommendation

Overview

- Remote I/O enables master devices such as PLCs to control the input and output of data from a remote location via network. The input and output signals can be either digital or analog.
- Customers are increasingly transitioning from older industrial protocols based on RS-485/RS-232 serial communication to Ethernet-based industrial protocols. The R-IN32 Series is a single-chip device that supports both types of industrial networks.

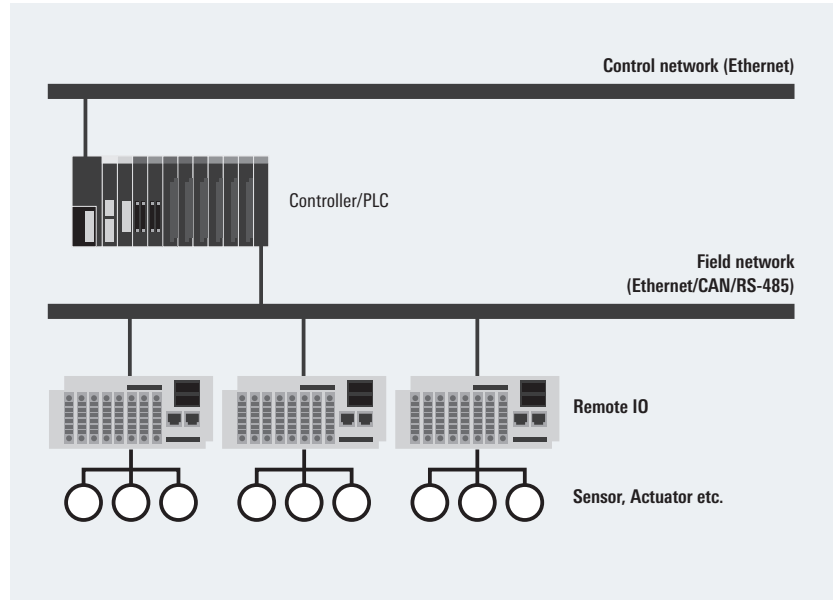

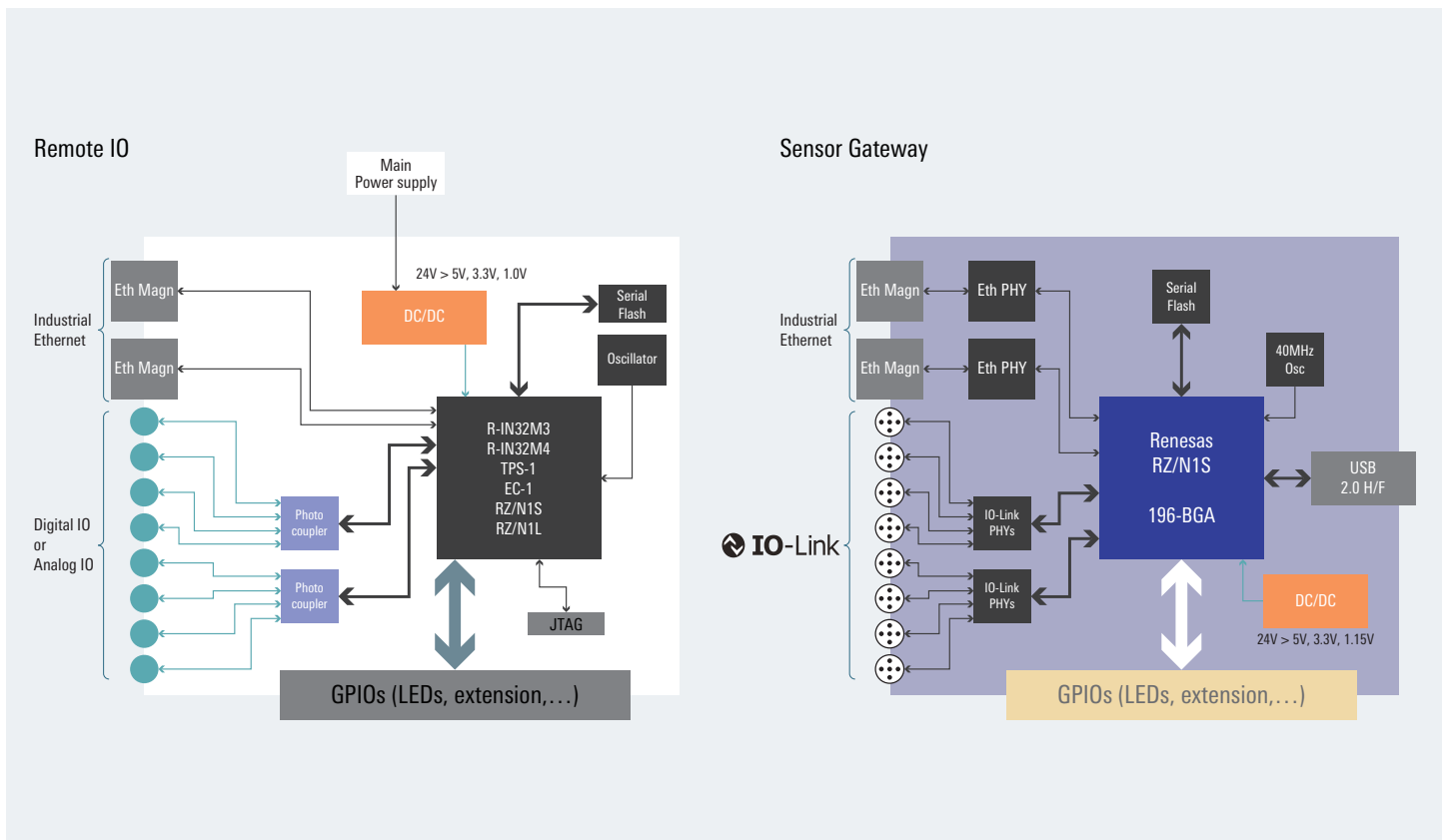

System Block Diagram



Recommended Products

Industrial Communication IC

Block	Category	Recommended Products	CPU	Operating Frequency (MHz)	Operating Voltage (V)	On-Chip RAM (Max.)	Features, etc.
Industrial Communication Controller	Factory Automation IC	R-IN32M3-EC	Cortex®-M3	100	3.3V (I/O) 1.0V (Core)	1.3MB (ECC)	<ul style="list-style-type: none"> Single-chip support for multiple industrial protocols, including EtherCAT. On-chip 100Mbps Ethernet PHY.
		R-IN32M3-CL	Cortex®-M3	100	3.3V (I/O) 1.0V (Core)	1.3MB (ECC)	<ul style="list-style-type: none"> Single-chip support for multiple industrial protocols, including CC-Link IE Field.
		R-IN32M4-CL3 	Cortex®-M4 processor with FPU	100	3.3V (I/O) 2.5V (PHY) 1.15V (Core)	1.3MB (ECC)	<ul style="list-style-type: none"> Support for multiple protocols, including CC-Link IE TSN, Ethernet/IP, and PROFINET Integrated 2-port gigabit Ethernet compatible PHY
		EC-1	Cortex®-R4 processor with FPU	150	3.3V (I/O) 1.2V (Core)	Tightly coupled memory 512KB + 32KB (ECC)	<ul style="list-style-type: none"> A communication chip with support for EtherCAT, combining architecture with excellent real-time performance and an integrated EtherCAT slave controller.
		TPS-1	—	—	3.3V (I/O) 1.0V (Core)	—	<ul style="list-style-type: none"> A device conforming to the PROFINET IRT standard, one of the industrial Ethernet communication standard involved in growing adoption of open networks, is available.
	RZ/N	RZ/N1S	Cortex®-A7	500	3.3V (I/O) 1.15V (Core)	6MB (ECC)	<ul style="list-style-type: none"> A device supports multiple protocols such as EtherCAT, EtherNet / IP, PROFINET, SERCOS, POWERLINK, IO Link Master.
			Cortex®-M3	125			
		RZ/N1L	Cortex®-M3	125	3.3V (I/O) 1.15V (Core)	6MB (ECC)	<ul style="list-style-type: none"> A device supports multiple protocols such as EtherCAT, EtherNet / IP, PROFINET, SERCOS, POWERLINK.
	RX700	RX72M 	RXv3	240	3.3V	1MB + 32KB (ECC)	<ul style="list-style-type: none"> High-performance RXv3 core and large memory capacity for high-precision motor control Arithmetic unit for trigonometric functions and collective register bank save function On-chip EtherCAT slave controller

Analog and Power Devices

Block	Category	Recommended Products	Main Specifications	Features, etc.
Power supply	DC/DC	RAA230152	Input voltage range: 7 to 28V Output voltage: 5.0V Max. output current: 3A	<ul style="list-style-type: none"> Auto PFM (low-load, low power operation) mode
		RAA230153	Input voltage range: 7 to 28V Output voltage: 0.8 to 6V Max. output current: 3A	
		RAA230231	Input voltage range: 4.5 to 16V Output voltage: CH1 3.3V, CH2 0.8 to 6V Max. output current: 3A	<ul style="list-style-type: none"> Auto PFM (low-load, low power operation) mode Dual channel DC/DC
		RAA212422	Dual synchronous rectification DC/DC regulator <ul style="list-style-type: none"> CH1: Vin = 3 to 40V, 1.1A output CH2: Vin = 2.7 to 5.5V, 1.5A 	<ul style="list-style-type: none"> Low-load mode Compact package: 3mm × 6mm TDFN
		ISL80019	Synchronous rectification regulator Vin = 2.7 to 5.5V, 1.5A	<ul style="list-style-type: none"> Low-load mode Compact package: 2mm × 2mm TDFN
Isolation	Tr-output photocoupler	PS2811-4	SSOP package LOW INPUT	<ul style="list-style-type: none"> Compact and high voltage tolerance, ideal for compact systems
		PS2801C-4	SSOP package	

Our Recommended Devices for Remote IO System

Industrial Communication IC

Today, Industrial Ethernet is expanding rapidly in factories, and machines and modules are required to support it. Features in this high demand includes support for multiple Industrial Ethernet protocols and excellent real-time responsiveness to improve factory productivity. The importance of these two aspects cannot be overemphasized. The R-IN32M Series from Renesas Electronics provides the above-mentioned functionality to help boost manufacturing productivity and reducing costs on the manufacturing line.

Advantages of the R-IN32M

1. Integrated real-time OS accelerator (HW-RTOS) and Ethernet accelerator

One of the most distinctive features of the R-IN32M3 is the high-speed operation with the basic function of the real-time OS in hardware to implement high-speed real-time response and high-precision communication control for industrial Ethernet communication. Because the hardware in the new R-IN32M3 Series covers heavy load operations for the CPU, the combination of the CPU and HW-RTOS result in ultra-high-speed real-time responsiveness five to ten times that of a conventional software real-time OS. In addition, the fluctuation caused by inconsistencies in the operation time with conventional CPU processing is reduced substantially from one-fifth to one-tenth of the previous level.

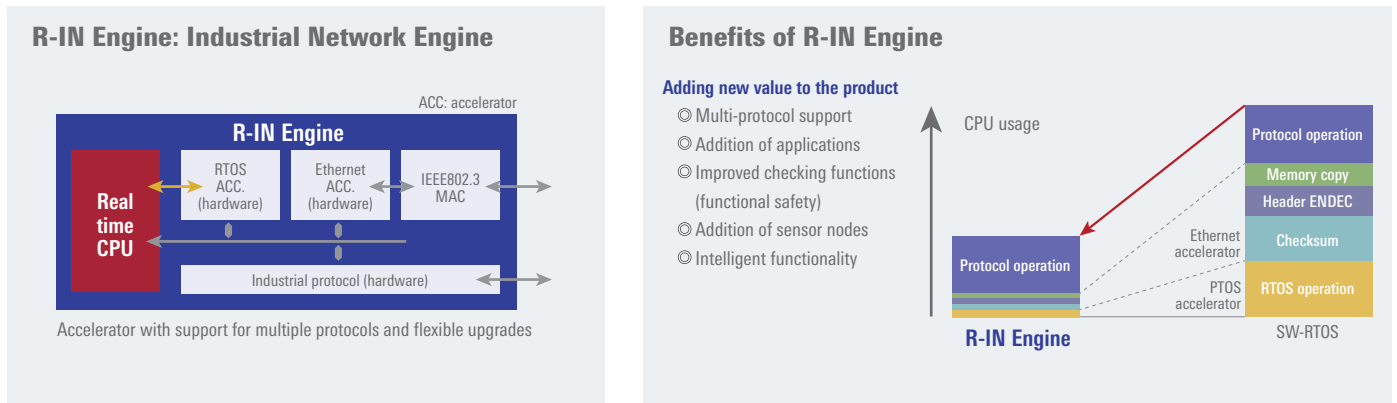

2. Multi-protocol support (EtherCAT, EtherNet/IP, PROFINET, etc.)

The R-IN32M3 Series supports various industrial Ethernet protocols, including CC-Link IE Field and EtherCAT, and conventional open network protocols.

Ethernet protocols:

EtherCAT*1, EtherNet/IP, PROFINET (RT), Modbus TCP, and CC-Link IE Field*2

Open network protocols:

CANopen, DeviceNet, Modbus RTU/ASCII, and CC-Link

Notes: 1. Supported by R-IN32M3-EC only.
2. Supported by R-IN32M3-CL only.

Supports Industry Ethernet Protocol	Recommended Products
CC-Link IE TSN Class B	R-IN32M4-CL3
CC-Link IE TSN Class A	R-IN32M4-CL3, RZ/N1, RZ/T1, R-IN32M3-EC/CL, RX72M
CC-Link IE Field	R-IN32M4-CL3, R-IN32M3-CL
EtherCAT	RZ/N1S, RZ/N1L, RZ/T1, EC-1, R-IN32M3-EC, RX72M
EtherNet/IP	RZ/N1S, RZ/N1L, RZ/T1, R-IN32M3, R-IN32M4-CL3, RX72M
Modbus/TCP	RZ/N1S, RZ/N1L, RZ/T1, R-IN32M3, R-IN32M4-CL3, RX72M
PROFINET RT	RZ/N1S, RZ/N1L, RZ/T1, R-IN32M3, R-IN32M4-CL3, RX72M
PROFINET IRT	TPS-1
ETHERNET POWERLINK	RZ/N1S, RZ/N1L
Sercos III	RZ/N1S, RZ/N1L
OPC-UA	RZ/N1S, RZ/N1L, RZ/T1, R-IN32M3, R-IN32M4-CL3, RX72M

Product list for R-IN engine

					
RZ/N1S	RZ/N1L	RZ/T1	R-IN32M3-EC	R-IN32M3-CL	R-IN32M4-CL3
Cortex®-A7 + Cortex®-M3 4p GbE Switch + 1 MAC EtherCAT Slave Controller Sercos	Cortex®-M3 4p GbE Switch + 1 MAC EtherCAT Slave Controller Sercos	Cortex®-R4 Processor with FPU + Cortex®-M3 2p Ether Switch + 1 MAC EtherCAT Slave Controller* (*Option)	Cortex®-M3 2p Ether Switch On chip PHY EtherCAT Slave Controller	Cortex®-M3 2p GbE Switch CC-Link IE Field Controller	Cortex®-M4 Processor with FPU 2p GbE Switch On chip GbE PHY CC-link IE TSN Controller CC-Link IE Field Controller

Industrial Ethernet Communication IC (R-IN32M4)

The R-IN32M4-CL3 is an Ethernet communication SoC that makes possible ultrahigh-speed, highly accurate motor control by maintaining time synchronization accuracy between devices of 1 millionth of a second or less to enable support for CC-Link IE TSN networks. This lets customers achieve ultrahigh-speed, highly accurate motor control in their application devices, speeding up TSN response in application devices requiring fast and responsive control, such as AC servos, actuators, and vision sensors, as well as remote I/O applications with heavy network usage.

R-IN32M4-CL3 Block Diagram

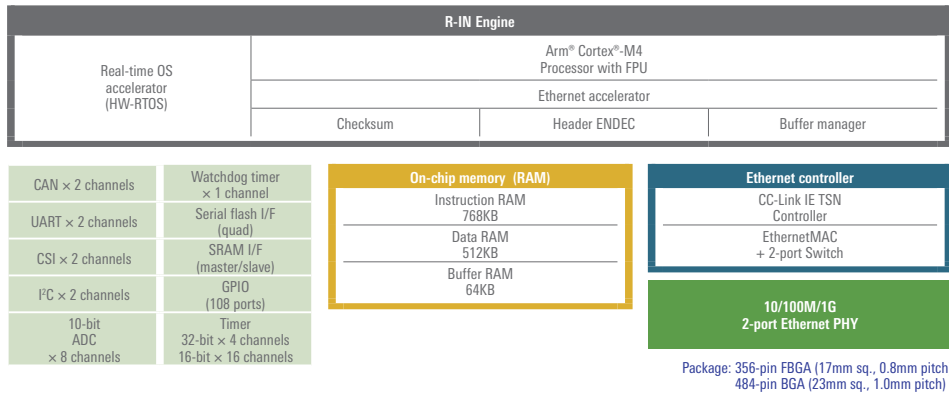

Fast real-time processing

- R-IN Engine
 - Arm® Cortex®-M4 processor with FPU (32-bit RISC CPU running at 100MHz)
 - Real-time OS accelerator
 - Ethernet accelerator

Support for Industrial Ethernet

- CC-Link IE TSN Controller
- On-chip 10/100/1,000Mb Ethernet PHY
- 1.3MB ECC memory (instruction RAM, data RAM, buffer RAM)

Many peripheral functions

- Serial flash memory interface for reduction in external ROM mounting area
- SRAM interface support (ability to connect external MPU)
- CAN × 2 channels, I²C × 2 channels
- Up to 106 general ports
- 10-bit SAR ADC (8 channels)

Industrial Ethernet Communication IC (R-IN32M3 Series)

The R-IN32M3-EC has an integrated 10/100 Ethernet PHY and requires no external PHY. This allows for a more compact module board. On the other hand, the R-IN32M3-CL implements the CC-Link IE protocol in hardware, is equipped with a 1Gbps Ethernet MAC, and (when paired with an external 1Gbps Ethernet PHY) supports 1Gbps Ethernet communication.

- | | |
|--|--|
| <ul style="list-style-type: none"> • R-IN32M3-EC: Supported protocols
EtherCAT, EtherNet/IP, PROFINET(RT), ModbusTCP, CC-Link, CANopen, DeviceNet, Modbus RTU/ASCII | <ul style="list-style-type: none"> • R-IN32M3-CL: Supported protocols
CC-Link IE Field, EtherNet/IP, PROFINET(RT), ModbusTCP, CC-Link, CANopen, DeviceNet, Modbus RTU/ASCII |
|--|--|

R-IN32M3-EC/R-IN32M3-CL Block Diagram

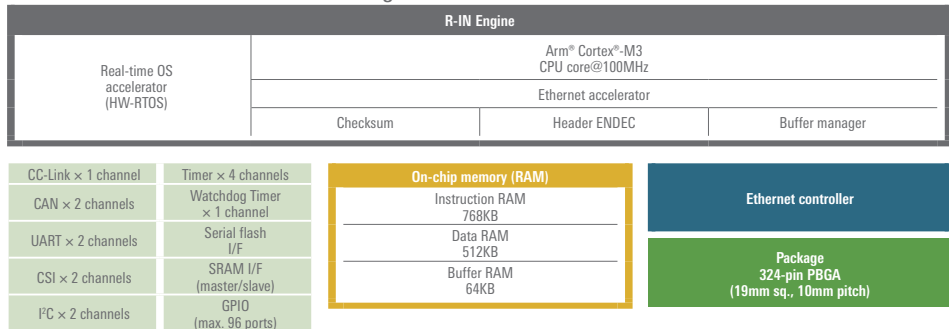

Fast real-time processing

- R-IN Engine
 - Arm® Cortex®-M3 (32-bit RISC CPU running at 100MHz)
 - Real-time OS accelerator
 - Ethernet accelerator

Support for Industrial Ethernet

- Multi-protocol support
 - Each product has a different custom controller.
EC version: On-chip EtherCAT controller
CL version: On-chip CC-Link IE controller
- On-chip 2-port Ethernet switch (IEEE 1588, DLR, cut-through hub function, etc.)
- 1.3MB ECC memory (instruction RAM, data RAM, buffer RAM)

Many peripheral functions

- Serial flash memory interface for reduction in external ROM mounting area
- SRAM interface support (ability to connect external MPU)
- CAN × 2 channels, I²C × 2 channels
- Up to 96 general ports

RZ/N1S Group

RZ/N1S housed Cortex®-A7 and a large size of built-in RAM in a small package. Since peripheral parts can be reduced, it can be used for small PLC, HMI, etc. In addition, since it has a proven R-IN engine as an accelerator for industrial Ethernet communication, it can be used for protocol gateway, sensor hub, etc.

System 2 × 16ch DMAC JTAG w/disable function (Security Option) CGC	Package 324-pin LFBGA 15mm × 15mm/0.8mm pitch 196-pin LFBGA 12mm × 12mm/0.8mm pitch	Interface 8 × UART 2 × I ² C 2 × CAN 6 × SPI 2 × USB 2.0 HS (Host/Func) Parallel Bus I/F (up to 32b bus)
Timer 6 × 16-bit GPT 6 × 32-bit GPT × 2 1 × WDT per CPU RTC	CPU Arm® Cortex®-A7 Core Processor 500MHz FPU MMU Debug GIC	Memory Interface Quad SPI with XiP NAND Flash I/F 2 × SDIO/eMMC
Display LCD Controller	Memory L1 Cache I-Cache 16 KB D-Cache 16 KB L2 Cache 128 KB SRAM 6 MB(with ECC)	Analog 12-bit ADC × 8 channels
Security (option) Secure boot	R-IN Engine CPU Arm®Cortex®-M3 125 MHz MPU Debug NVIC HW-RTOS Accelerator Ethernet Accelerator	Ethernet EtherCAT Controller Sercos III Controller Ether Switch (4port+1port) (QoS, Aging, EEE, Snooping, DLR, TDMA, Storm protection cut through, Jumbo frames) 2 × independent GMAC

RZ/N1L Group

RZ/N1L equipped with “R-IN engine” which is an accelerator for industrial Ethernet communication can be used for the communication parts of industrial network device where real-time responsibility is required. With integrated EtherCAT and Sercos III slave dedicated H/W, it is possible to handle a wide range of protocols.

System 2 × 16ch DMAC JTAG CGC	Package 196-pin LFBGA 12mm × 12mm/0.8mm pitch	Interface 8 × UART 2 × I ² C 2 × CAN 6 × SPI 2 × USB 2.0 HS (Host/Func) Parallel Bus I/F (Slave 8b bus)
Timer 6 × 16-bit GPT 6 × 32-bit GPT × 2 1 × WDT per CPU	Memory SRAM 6 MB (with ECC)	Memory Interface Quad SPI with XiP NAND Flash I/F 1 × SDIO/eMMC
	R-IN Engine CPU Arm® Cortex®-M3 125 MHz MPU Debug NVIC HW-RTOS Accelerator Ethernet Accelerator	Analog 12-bit ADC × 8 channels
	Ethernet EtherCAT Controller Sercos III Controller Ether Switch (4port + 1port) (QoS, Aging, EEE, Snooping, DLR, TDMA, Storm protection cut through, Jumbo frames) GMAC	

PROFINET Communication IC (TPS-1)

This is an industrial networking ASIC targeted at providing a complete hardware solution for PROFINET IO Device. It has integrated dual port PHY and PROFINET IRT switch with bridge delay of less than 3μs.

Package 196-pin BGA 15mm × 15mm/1.0mm pitch	Timers 1 × WDT
CPU CPU dedicated for PROFINET	Interfaces 2 Ethernet interface with PHYs (100Base-Tx/FX) 48 GPIO (*) 8/16-bit host I/F (*) SPI (*) 5 GPIO for internal signals I ² C for fiber optic diagnosis SPI for Flash (*:selectable)
Memory For cyclic exchange: 340Byte	
PROFINET IO core (Protocol Handling/IRT Switch/Time Sync)	

EtherCAT Communication IC (EC-1)

EC-1 is an efficient solution that is simple to implement, yet have the processing power to handle the I/O as well as the network interface.

Package 196-pin BGA 12mm × 12mm/0.8mm pitch	Timers 6 × 16-bit CMT 2 × 32-bit CMT2 1 × WDT 1 × iWDT
CPU Cortex®-R4 Processor with FPU 150MHz FPU MPU Debug VIC	Interfaces 5 × SCIF 1 × I ² C 1 × CAN 2 × RSPI USB HS (Host/Func) GPIO QSPI (Flash I/F) w/ Direct Access from CPU
Memory ATCM: 512KB with ECC BTCM: 32KB with ECC I Cache: 8KB w/ ECC D Cache: 8KB w/ ECC	
System 2 × 16ch DMAC	EtherCAT Slave Controller

CONNECT IT! ETHERNET RZ/N

CONNECT IT! ETHERNET RZ/N is the perfect solution kit for developers new to developing for the RZ/N1. In addition to an evaluation board, it includes a JTAG emulator and various sample software projects. Just set up the board according to the startup manual and you can evaluate projects employing Linux OS or the R-IN Engine, as well as master and slave communication using EtherCAT or other protocols. In addition to versions with three different CPU boards (RZ/N1D, RZ/N1S, and RZ/N1L), an expansion board is also available that enables you to evaluate a variety of peripheral functions. Choose the evaluation board that best matches your application. This solution kit lets you experience the performance and functionality of the RZ/N1.



Solution Kit Contents

- JTAG emulator
 - IAR I-jet Lite (20-pin flat ribbon/USB cable)
- 2 USB cables
- RZ/N Solution Kit DVD
 - User’s manual
 - OS (Linux, ThreadX[®] *, HW-RTOS)
 - Software PLC CODESYS
 - Protocol stacks
 - EtherCAT[®]
 - Modbus
 - PROFINET[®] *
 - EtherNet/IP[®] *
- Startup manuals
- Pin setting tool

* Evaluation version

EC-1 Remote I/O Solution

To enable as many customers as possible to undertake development quickly, easily, and with peace of mind, Renesas offers this solution combining hardware, software, integrated development environment, and other necessary elements. The board has eight input and eight output channels and is designed to operate at 24V to simulate an actual remote I/O product. Since the board and sample software have already passed EtherCAT certification testing, using the circuit diagrams of the board for reference can greatly reduce the workload involved in developing a commercial product.

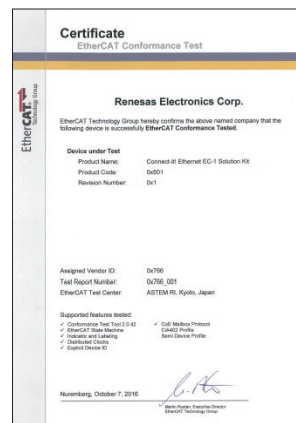
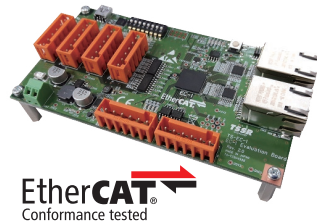

EC-1 Remote I/O Solution

- TS-EC-1 board*¹
- Sample software*²
- Application manual*²
- Circuit diagram*³

- Notes:
1. The TS-EC-1 board is available for purchase from Tessera Technology Inc.
 2. The EC-1 Series remote I/O program package is available for download on the Renesas website.
 3. Contact a Renesas representative for details.

RX72M Solution

This solution consists of RX72M-based evaluation board along with sample software for the OS, middleware and industrial network communication protocols.

Enables to cover 70% of the major industrial network communication protocols in the market, and It has been passed for conformance with the three major protocols (EtherCAT, PROFINET RT, EtherNet/IP)

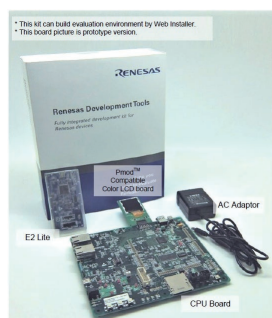

Renesas Starter Kit+ for RX72M

Renesas Starter Kit+ for RX72M

- EtherCAT, 2ch Ethernet port (MII)
- RS485, CAN transceiver (Support field network)
- 32-bit SDRAM
- Connectors for Δ - Σ modulator I/F

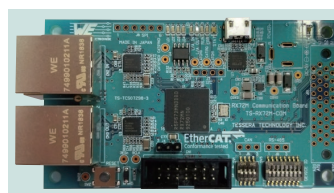

TS-RX72M-COM: TESSERA TECHNOLOGY INC.

Network solution board: TS-RX72M-COM*

- EtherCAT, 2ch Ethernet port (MII)
- RS485, CAN transceiver (Support field network)

Note: TS-RX72M-COM board is available for purchase from Tessera Technology Inc. or Internet purchase. Please contact a Renesas representative for details

Sensor Interface

Sensors are surely the fastest growing market among various factory sectors as the Industry is moving toward the adoption of Industrial Internet of Things.

Sensors, or so called Edge Applications, now play a vital role into Smart Factory visualization down to all sensor levels and big data gathering for analytics that improve manufacturing processes.

Functional Blocks

Functions of sensing systems can be classified with 3 functional blocks to take sensor signal accurately, to process the signal and to output the data. Requirements for each block vary widely over the applications from the simple function sensors such as small pressure sensors to PLC Analog modules that require the complicated and flexible signal processing.

Our solution using Sensor Signal Conditioners (SSC) and Microcontrollers with Sensor Interface analog functions to fit to wide range of market needs.

Factory Automation Sensors



Process Automation sensors



Functional Block Diagram

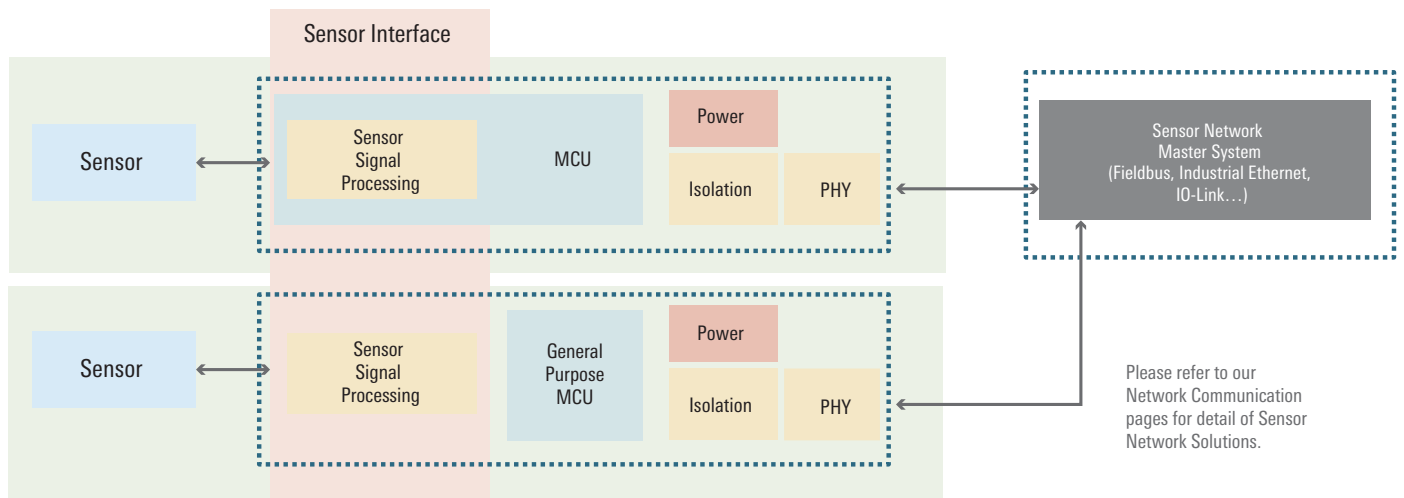

Recommended Products

Block	Recommended Products	Operating Frequency (MHz)	Operating Voltage (V)	On-Chip Memory (Max.)	Features, etc.
MCU for Sensor Controller (Featured Products)	RX23E-A NEW	32MHz	1.8 to 5.5	256KB Flash 32KB RAM 8KB Data Flash	Incorporates an analog frontend with low-noise and low-ripple characteristics enabling measurement with an accuracy better than 0.1% without calibration. Ideal for sensors, controllers, or test equipment requiring sensing using minute analog signals representing temperature, pressure, flow, weight, distortion, etc. The RXv2 CPU core excels in DSP and FPU calculations. Enables implementation of high-precision measurement, control, or communication using an one-chip.
	RA2A1 NEW	48MHz	1.6 to 5.5	256KB Flash 32KB RAM 8KB Data Flash	High-performance Arm® Cortex®-M23 core. Integrates numerous digital peripheral functions and analog functions such as 24-bit ΔΣ ADC and 16-bit SARADC that can be used to measure and process analog signals from sensors and also support human interface functionality such as USB and touch panels.
	RL78/I1E	32MHz	2.4 to 5.5	32KB Flash 4KB RAM 8KB Data Flash	Power-efficient RL78 MCU with 24-bit ΔΣ A/D converter ideal for high-precision measurement required by industrial devices, measurement of flow, pressure, weight, or distortion for applications in the environmental infrastructure field, or photometry for applications in the healthcare field; 12-bit D/A converter; and analog frontend with configurable amplifier. Compact (4mm × 4mm) package that enables design of space-efficient applications.

Functional Block	Part Number	Type	Voltage	Output	ADC	Package	Typical Application/Features
Sensor Signal Conditioner (Featured Products)	ZSC31014	Resistive	2.7 to 5.5 V	Digital	14 bit	SOIC, Wafer	Industrial/I ² C Sensors
	ZSC31050	Resistive	2.7 to 40 V	Analog/Digital	15 bit	SSOP, Wafer	Industrial/Current Loop
	ZSSC3026	Resistive	1.8 to 3.6 V	Digital	16 bit	Wafer	Consumer, White Goods
	ZSSC3224	Resistive	1.68 to 3.6 V	Digital	24 bit	QFPN, Wafer	Industrial/Consumer
	ZSSC3240 NEW	Resistive	2.7 to 48 V	Analog/Digital	24 bit	QFPN, Wafer	Industrial/Current Loop
	ZSSC3123	Capacitive	2.3 to 5.5 V	Digital, PDM	14 bit	TSSOP, Wafer	Industrial
	ZSSC3230 NEW	Capacitive	1.68 to 3.6 V	Digital, PDM	18 bit	PQFN, Wafer	Industrial/Consumer

Functional Block	Part Number	Type	Options	Typical Application/Features
PHY for Field Communication	ZIOL2401	IO-Link Line Driver	Dual Channel	The ZIOL2x01 is a line driver/level shifter IC that provides HV I/O channels with a wide range of configurable system features. It addresses the physical layer of sensor/actuator systems in factory automation applications and is specifically designed to support the communication standard IO-Link.
			Single Channel	
	ASI4U	AS-I 3 PHY	ASI V3 Compliant	The ASI4U is used as a part of a master or slave node and work as an interface to the physical bus. The device realize power supply, physical data transfer and communication protocol handling. All products are fully compliant with AS-Interface Complete Specification V3.0.
	SAP5	AS-I 3 PHY	ASI V3 Compliant	The SAP5 is a dedicated ASI V3.0 device supporting AS-I safety functions.
	ASI4U-V5 NEW	AS-I 5 PHY	ASI V5 Compliant	The ASI4U-V5 is the industry's first silicon solution to fulfill the AS-I 5 (Actuator-Sensor-Interface version 5) standard for industrial network equipment that enables comprehensive Industry 4.0 applications.
ISL32704E	RS485 Driver	RS-485/RS-422 Compliant	The ISL32704E is a galvanically isolated, differential bus transceiver designed for bidirectional data transmission and meeting the RS-485 and RS-422 standards for balanced communication.	

Sensor Interface Lineup

Sensor Interface lineup

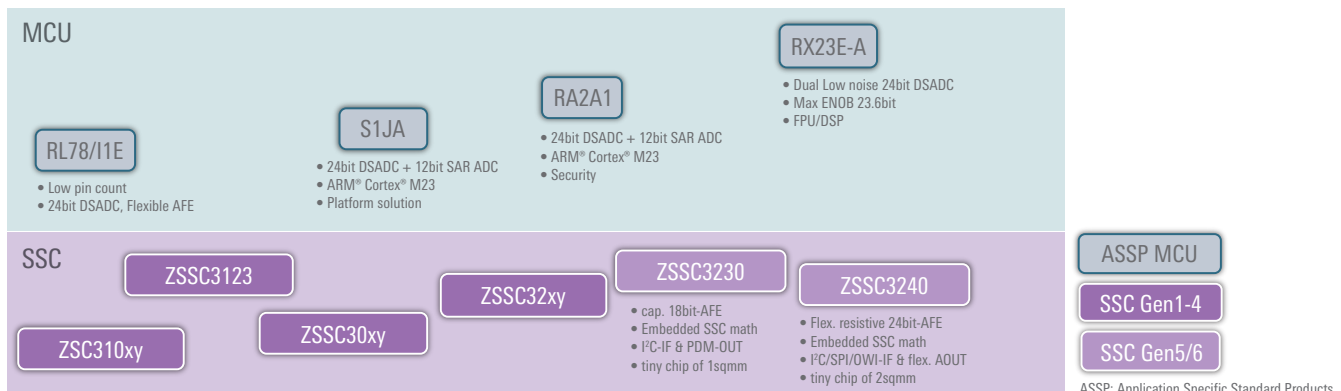

Microcontroller and SoC Development Tools

RX Family Development Tools

Renesas supports all stages of development phase in RX by supplying integrated development environments, real-time OSes, middleware, and programming tools that dramatically enhance the development process. Renesas integrated development environments will enable you to accomplish coding, building, and debugging tasks quick and easy, helping to reduce system development time.

In addition, a variety of software (middleware modules, peripheral function modules) introduced by a new concept called Firmware Integration Technology (FIT) is available for the RX Family. This software code can be incorporated into user applications and simplifies the process of migration among RX microcontrollers, thereby realizing microcontroller platform for general-purpose inverters needed in the development of a wide variety of products.

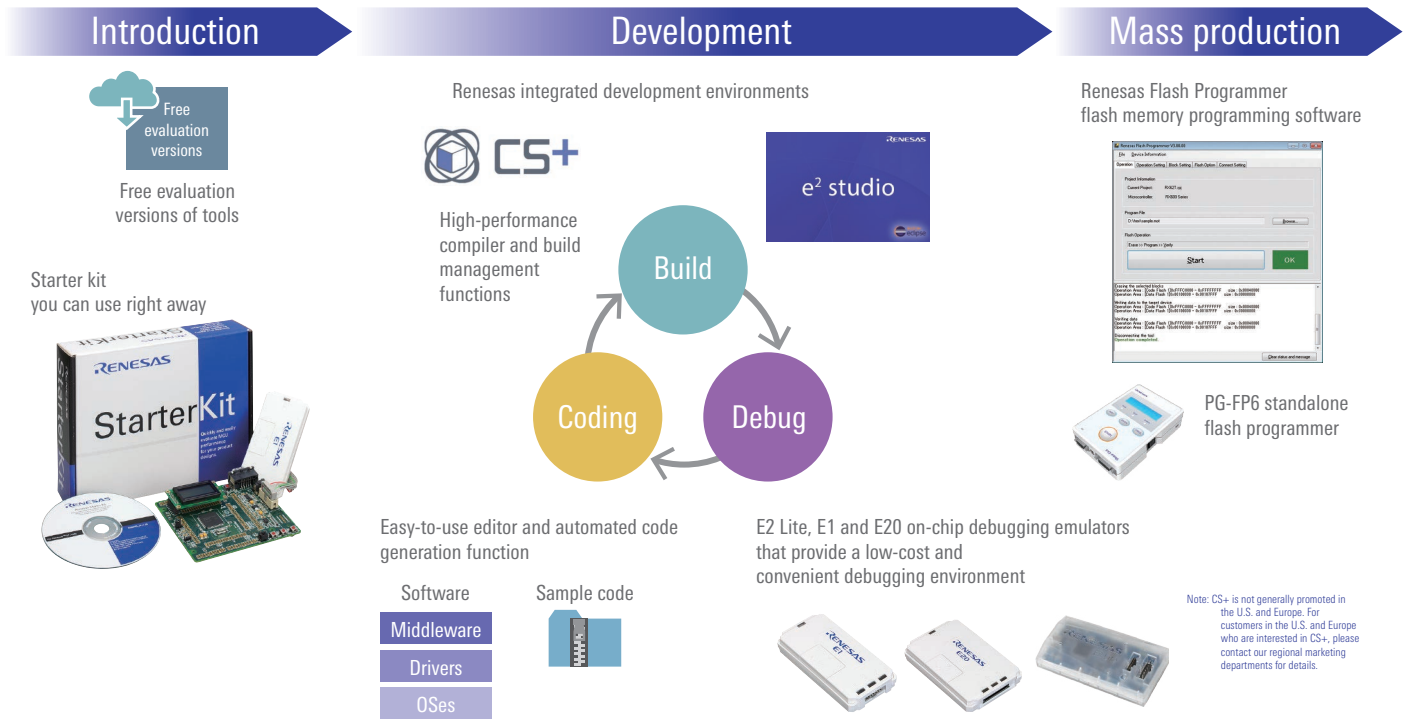

RA Family Development Environment

The Renesas RA Family is a new family of 16-bit microcontrollers based on the ARM® Cortex®-M core architecture. It leverages robust security and flexible software solutions to meet the expandability, power efficiency, and performance requirements of embedded system end products.

Integrated Development Environment (IDE)

- Renesas e² studio
- Keil MDK

Compiler

- GNU, Arm Compiler version 6

Emulator

- Segger J-Link
- Renesas E2 emulator, E2 Lite emulator

Flash Memory Programmer

- Renesas PG-FP6
- Third party solutions

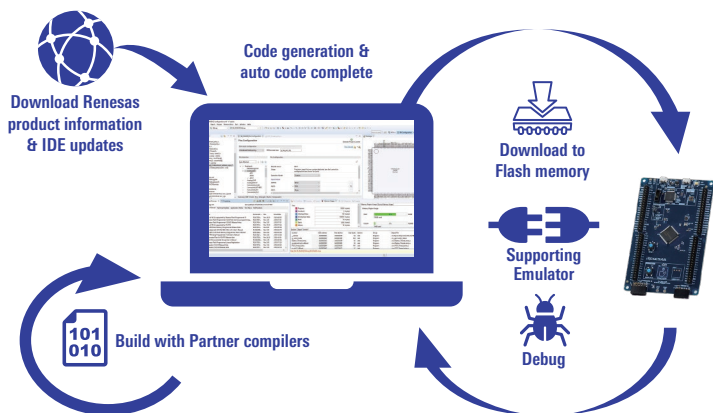











Evaluation Kit

- Full MCU evaluation including on-chip debugger
- Individual kits for several products of each Renesas RA Series are available



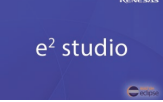







RZ/T, RZ/N Series Development Tools

RZ/T, RZ/N Series: Development Environments (Integrated Development Environments)

				
Support Series	RZ/T	RZ/T, RZ/N	RZ/T	RZ/T, RZ/N
Development environments	<ul style="list-style-type: none"> DS-5  	<ul style="list-style-type: none"> IAR Embedded Workbench® for Arm®  	<ul style="list-style-type: none"> eBinder  	<ul style="list-style-type: none"> e² studio³ 
Compilers	<ul style="list-style-type: none"> Arm CC¹ 	<ul style="list-style-type: none"> IAR C/C++ compiler² 	<ul style="list-style-type: none"> Arm CC¹ 	<ul style="list-style-type: none"> GNU tool⁴
ICEs	<ul style="list-style-type: none"> DSTREAM™ ULINKpro™ ULINKproD™ ULINK2™  	<ul style="list-style-type: none"> I-jet™/I-jet Trace™ for Arm® Cortex®-A/R/M JTAGjet-Trace  	<ul style="list-style-type: none"> PARTNER-Jet2 from Kyoto Microcomputer adviceLUNA II from DTS INSIGHT 	<ul style="list-style-type: none"> J-Link LITE J-Link series from Segger⁵ 

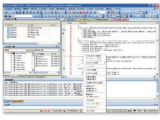
- Notes:
1. Arm CC is available in a free evaluation version that provides full functionality but is limited to 30 days of use. Contact a DS-5 sales agent for details.
 2. A free evaluation license is available provided the 30-day time-limited evaluation or the permanent 32KB size-limited evaluation. (www.iar.com/EWARM)
 3. Eclipse-based development environment from Renesas (<http://www.renesas.com/e2studio>)
 4. GNU TOOLS & SUPPORT Website (<https://gcc-renesas.com>)
 5. Renesas does not handle ICes from Segger. Contact a sales agent for details.

RZ/T, RZ/N Series Development Tools (Debuggers, ICes)

			
Debuggers	<ul style="list-style-type: none"> PARTNER-Jet2  	<ul style="list-style-type: none"> microVIEW-PLUS  	<ul style="list-style-type: none"> CSIDE version 7 
ICEs		<ul style="list-style-type: none"> adviceLUNA II  	<ul style="list-style-type: none"> PALMICE4  JTAG Model High-Volume Trace Model
Compatible compilers	<ul style="list-style-type: none"> exeGCC from Kyoto Microcomputer GNU tool¹ Arm CC² IAR C/C++ compiler,³ etc. 	<ul style="list-style-type: none"> Arm CC² GNU tool,¹ etc. 	<ul style="list-style-type: none"> Arm CC² IAR C/C++ compiler³ GNU tool,¹ etc.

- Notes:
1. GNU TOOLS & SUPPORT Website (<https://gcc-renesas.com>)
 2. Arm CC is available in a free evaluation version that provides full functionality but is limited to 30 days of use. Contact a DS-5 sales agent for details.
 3. A free evaluation license is available provided the 30-day time-limited evaluation or the permanent 32KB size-limited evaluation. (www.iar.com/EWARM)

e² studio: Integrated Development Environment Based on Eclipse (RZ/T Series)

e² studio is an integrated development environment based on the Eclipse open source integrated development environment and CDT plug-ins supporting development in C/C++. The version of e² studio that is compatible with the RZ/T series provides support for a code generation plug-in.

• C/C++ perspective: code generation plug-in

A code generation plug-in is available that enables the user to generate device driver programs for peripheral functions of Renesas microcontrollers (timers, UART, A/D converter, etc.) by entering settings in a graphical user interface. It is possible to specify the processing of multiplexed pins in a pin table and view a pin assignment diagram to confirm the settings.

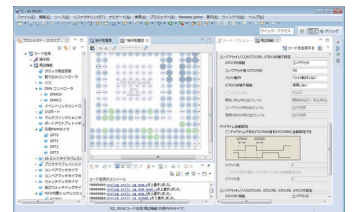

AP4: Code Generation Support Tool (RZ/T Series)

AP4 is a standalone tool that automatically generates peripheral function control programs (device driver programs) based on settings entered by the user. The build tool (compiler) is selectable. This makes it possible to generate peripheral function control program code to match a specific build tool and enables interoperation with integrated development environments. The version of AP4 that is compatible with the RZ/T series can generate compatible source code for IAR Embedded Workbench® for Arm® from IAR Systems, Development Studio (DS-5™) from Arm®, and e² studio (GNU Tools).

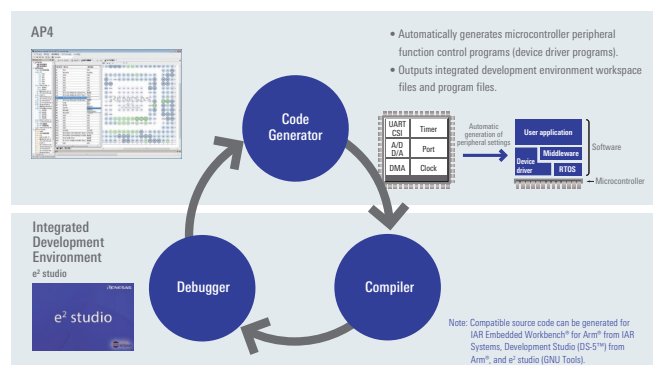
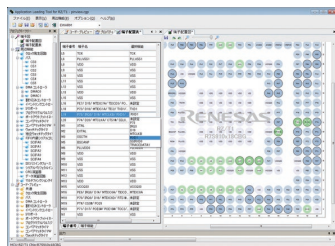

Notice

1. Descriptions of circuits, software and other related information in this document are provided only to illustrate the operation of semiconductor products and application examples. You are fully responsible for the incorporation or any other use of the circuits, software, and information in the design of your product or system. Renesas Electronics disclaims any and all liability for any losses and damages incurred by you or third parties arising from the use of these circuits, software, or information.
 2. Renesas Electronics hereby expressly disclaims any warranties against and liability for infringement or any other claims involving patents, copyrights, or other intellectual property rights of third parties, by or arising from the use of Renesas Electronics products or technical information described in this document, including but not limited to, the product data, drawings, charts, programs, algorithms, and application examples.
 3. No license, express, implied or otherwise, is granted hereby under any patents, copyrights or other intellectual property rights of Renesas Electronics or others.
 4. You shall not alter, modify, copy, or reverse engineer any Renesas Electronics product, whether in whole or in part. Renesas Electronics disclaims any and all liability for any losses or damages incurred by you or third parties arising from such alteration, modification, copying or reverse engineering.
 5. Renesas Electronics products are classified according to the following two quality grades: "Standard" and "High Quality". The intended applications for each Renesas Electronics product depends on the product's quality grade, as indicated below.
 - "Standard": Computers; office equipment; communications equipment; test and measurement equipment; audio and visual equipment; home electronic appliances; machine tools; personal electronic equipment; industrial robots; etc.
 - "High Quality": Transportation equipment (automobiles, trains, ships, etc.); traffic control (traffic lights); large-scale communication equipment; key financial terminal systems; safety control equipment; etc.
 Unless expressly designated as a high reliability product or a product for harsh environments in a Renesas Electronics data sheet or other Renesas Electronics document, Renesas Electronics products are not intended or authorized for use in products or systems that may pose a direct threat to human life or bodily injury (artificial life support devices or systems; surgical implantations; etc.), or may cause serious property damage (space system; undersea repeaters; nuclear power control systems; aircraft control systems; key plant systems; military equipment; etc.). Renesas Electronics disclaims any and all liability for any damages or losses incurred by you or any third parties arising from the use of any Renesas Electronics product that is inconsistent with any Renesas Electronics data sheet, user's manual or other Renesas Electronics document.
 6. When using Renesas Electronics products, refer to the latest product information (data sheets, user's manuals, application notes, "General Notes for Handling and Using Semiconductor Devices" in the reliability handbook, etc.), and ensure that usage conditions are within the ranges specified by Renesas Electronics with respect to maximum ratings, operating power supply voltage range, heat dissipation characteristics, installation, etc. Renesas Electronics disclaims any and all liability for any malfunctions, failure or accident arising out of the use of Renesas Electronics products outside of such specified ranges.
 7. Although Renesas Electronics endeavors to improve the quality and reliability of Renesas Electronics products, semiconductor products have specific characteristics, such as the occurrence of failure at a certain rate and malfunctions under certain use conditions. Unless designated as a high reliability product or a product for harsh environments in a Renesas Electronics data sheet or other Renesas Electronics document, Renesas Electronics products are not subject to radiation resistance design. You are responsible for implementing safety measures to guard against the possibility of bodily injury, injury or damage caused by fire, and/or danger to the public in the event of a failure or malfunction of Renesas Electronics products, such as safety design for hardware and software, including but not limited to redundancy, fire control and malfunction prevention, appropriate treatment for aging degradation or any other appropriate measures. Because the evaluation of microcomputer software alone is very difficult and impractical, you are responsible for evaluating the safety of the final products or systems manufactured by you.
 8. Please contact a Renesas Electronics sales office for details as to environmental matters such as the environmental compatibility of each Renesas Electronics product. You are responsible for carefully and sufficiently investigating applicable laws and regulations that regulate the inclusion or use of controlled substances, including without limitation, the EU RoHS Directive, and using Renesas Electronics products in compliance with all these applicable laws and regulations. Renesas Electronics disclaims any and all liability for damages or losses occurring as a result of your noncompliance with applicable laws and regulations.
 9. Renesas Electronics products and technologies shall not be used for or incorporated into any products or systems whose manufacture, use, or sale is prohibited under any applicable domestic or foreign laws or regulations. You shall comply with any applicable export control laws and regulations promulgated and administered by the governments of any countries asserting jurisdiction over the parties or transactions.
 10. It is the responsibility of the buyer or distributor of Renesas Electronics products, or any other party who distributes, disposes of, or otherwise sells or transfers the product to a third party, to notify such third party in advance of the contents and conditions set forth in this document.
 11. This document shall not be reprinted, reproduced or duplicated in any form, in whole or in part, without prior written consent of Renesas Electronics.
 12. Please contact a Renesas Electronics sales office if you have any questions regarding the information contained in this document or Renesas Electronics products.
- (Note 1) "Renesas Electronics" as used in this document means Renesas Electronics Corporation and also includes its directly or indirectly controlled subsidiaries.
 (Note 2) "Renesas Electronics product(s)" means any product developed or manufactured by or for Renesas Electronics.

(Rev.4.0-1 November 2017)

SALES OFFICES

Refer to "<http://www.renesas.com/>" for the latest and detailed information.

Renesas Electronics Corporation

TOYOSU FORESTIA, 3-2-24 Toyosu, Koto-ku, Tokyo 135-0061, Japan

Renesas Electronics America Inc. Milpitas Campus

1001 Murphy Ranch Road, Milpitas, CA 95035, U.S.A.
 Tel: +1-408-432-8888, Fax: +1-408-434-5351

Renesas Electronics America Inc. San Jose Campus

6024 Silver Creek Valley Road, San Jose, CA 95138, USA
 Tel: +1-408-284-8200, Fax: +1-408-284-2775

Renesas Electronics Canada Limited

9251 Yonge Street, Suite 8309 Richmond Hill, Ontario Canada L4C 9T3
 Tel: +1-905-237-2004

Renesas Electronics Europe GmbH

Arcadiastrasse 10, 40472 Düsseldorf, Germany
 Tel: +49-211-6503-0, Fax: +49-211-6503-1327

Renesas Electronics (China) Co., Ltd.

Room 101-F01, Floor 1, Building 7, Yard No. 7, 8th Street, Shangdi, Haidian District, Beijing 100085, China
 Tel: +86-10-8235-1155, Fax: +86-10-8235-7679

Renesas Electronics (Shanghai) Co., Ltd.

Unit 301, Tower A, Central Towers, 555 Langao Road, Putuo District, Shanghai 200333, China
 Tel: +86-21-2226-0888, Fax: +86-21-2226-0999

Renesas Electronics Hong Kong Limited

Unit 1601-1611, 16/F., Tower 2, Grand Century Place, 193 Prince Edward Road West, Mongkok, Kowloon, Hong Kong
 Tel: +852-2265-6888, Fax: +852 2886-9022

Renesas Electronics Taiwan Co., Ltd.

13F, No. 363, Fu Shing North Road, Taipei 10543, Taiwan
 Tel: +886-2-8175-9600, Fax: +886 2-8175-9670

Renesas Electronics Singapore Pte. Ltd.

80 Bendemeer Road, #06-02 Singapore 339949
 Tel: +65-6213-0200, Fax: +65-6213-0300

Renesas Electronics Malaysia Sdn.Bhd.

Unit No 3A-1 Level 3A Tower 8 UOA Business Park, No 1 Jalan Pengaturcara U1/51A, Seksyen U1, 40150 Shah Alam, Selangor, Malaysia
 Tel: +60-3-5022-1288, Fax: +60-3-5022-1290

Renesas Electronics India Pvt. Ltd.

No.777C, 100 Feet Road, HAL 2nd Stage, Indiranagar, Bangalore 560 038, India
 Tel: +91-80-67208700

Renesas Electronics Korea Co., Ltd.

17F, KAMCO Yangjae Tower, 262, Gangnam-daero, Gangnam-gu, Seoul, 06265 Korea
 Tel: +82-2-558-3737, Fax: +82-2-558-5338