

White Paper

Industrial HMI in a Package

Stefan Rank, Business Development Manager, MPU Solutions, Renesas Electronics Corp.

October 2018

Abstract

Driven by the smart phone user experience, Human-Machine-Interfaces (HMIs) are continuously taking over the control of more and more differentiated equipment in industrial, medical, access control, and home and building automation, as well as consumer segments. With increasing technical requirements in these markets, there is also a rise in complexity and cost of the solutions that can cater to new innovative equipment design. While easy-to-use MCUs clearly underperform in these new sophisticated implementations, high-end industrial MPUs bring the inherent complexity in hardware and software, with the latter leading to large follow-on costs. RZ/A embedded MPUs in combination with the new RZ/A Software Package provide the best of two worlds with MPU performance and MCU-cost. The RZ/A Software Package is a fully integrated software package, including real-time operating system, drivers, middleware, and sample applications, targeting the design of camera-GUI-display implementations. The RZ/A Software Package facilitates a significant acceleration in innovative HMI design, as no software integration is required and camera/display adjustments can be configured graphically and checked in real-time without recompiling.

Introduction

Renesas has been the worldwide leader in industrial and automotive MCUs for a long time. This is partly based on proprietary architectures, such as RL78 or RX, but also, and more recently, on ARM®-core-based architectures, with the big name here being Renesas Synergy™. Synergy has ARM Cortex® M-based S1, S3, S5, and S7 MCUs that can be used for HMI designs with ascending performance levels. One important point in this market is that MCUs facilitate the fastest time to market and ease of use. This is exactly where Synergy MCUs outperform the overall MCU market.

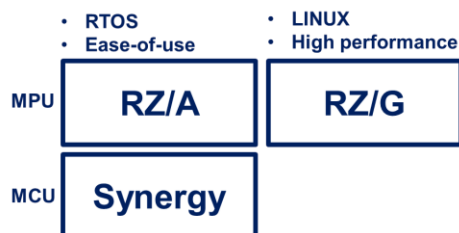

Figure 1 RZ/A embedded MPUs provide MPU performance and MCU ease of use

For high-end HMIs with the highest computational performance, advanced 3D rendering, and fastest video encoding and decoding, Renesas offers ARM Cortex A-based RZ/G MPUs to be used with the CIP™ Linux™ Platform. CIP stands for Civil Infrastructure Platform™ and targets all kinds of industrial equipment required for the advanced society. Once you upgrade to the high-end MPU space, ease of use is typically lost as architectures and software environments bear their inherent complexities. But with MCUs clearly showing performance limitations, designers aiming to upgrade to high-performance will inevitably face the complexity challenge. There is only one exception to this rule – Renesas RZ/A embedded MPUs. With a large on-chip SRAM, a Memory Management Unit, and a powerful Cortex A9 core, it is a highly differentiated device that still allows designers to keep their designs simple.

Furthermore, Renesas has now added the RZ/A Software Package that enables designers to immediately start HMI designs for advanced applications without the usually required upfront software integration task. This document will discuss the design environment around RZ/A embedded MPUs, including the new RZ/A Software Package from Renesas, and explain how they lead to innovative industrial HMIs more quickly, more easily, and with less cost.

HMI Equipment Overview

Modern Human Machine Interfaces take in data from the outside world, process and analyze the data, add data and interoperability, and then intuitively present the combination to the human user. Typically, what the user sees is the Graphical User Interface (GUI), even though an HMI can also be based on audible data instead of graphics. This means a GUI is an HMI, but an HMI isn't necessarily a GUI. Many implementations will also add text-to-speech or speech-to-text functionality. In this white paper, we focus on the camera-GUI-display chain, as this is the most widely used HMI implementation in the industrial market for RZ/A. Each component sees increasing performance requirements and needs to be supported by integrated software on the driver, middleware, and API levels.



Figure 2 Industrial HMI camera-GUI-display chain

General hardware requirements for industrial HMI implementation

Computational Architecture

An MPU to be used in an industrial HMI should have high computational performance provided by an advanced CPU core and an architecture that supports, as best as possible, the target use cases. Requirements include fast computation, fast image rendering by a GPU, and possibly video coding capabilities in hardware.

Camera inputs

The camera interface block is the hardware block that interfaces with different image sensor interfaces and provides a standard output that can be used for subsequent image processing. A typical camera interface would support, at a minimum, a parallel interface; although, today many camera interfaces support the MIPI CSI interface. Designers continuously move to higher resolution image sensors and low-power interfaces. While 1MP was a sufficient resolution a short while ago, designers now look at higher resolution multi-megapixel cameras, mainly driven by security cameras and artificial intelligence applications.

SRAM for buffer operation

The SRAM is the place that stores image information, which comes from the image sensor that is currently being built up or that is pushed to the display controller. In a typical graphical HMI, two buffer images would be stored; i.e., a front buffer and back buffer.

Video Display Controller

The video display controller is the main component of the video signal generator logic and is responsible for generating the timing of video signals such as the horizontal and vertical synchronization signals and the blanking interval signal.

General software requirements for HMI implementation

Software Package

A software package is an integrated suite of software with an Operating System (OS), such as an RTOS, that scales with end-product complexity and simplifies complex system-level services. A software package for HMI implementation should also integrate an application framework and pre-integrated middleware for communication, security, USB, GUI, and file system.

Software Tools

Designed to accelerate time to market through rapid code development, software tools facilitate file management, software, and MCU configuration, code generation, compilation, debugging, and intuitive graphic interface design.

Integrated Development Environment

An Integrated Development Environment (IDE) is a software application that provides comprehensive facilities to computer programmers for software development. An IDE normally consists of a source code editor, build automation tools, and a debugger. Most modern IDEs have intelligent code completion.

GUI framework for HMIs

The goal of a Graphical User Interface (GUI) framework is to accelerate and optimize GUI development for embedded applications. With a complete WYSIWYG screen design environment for drag-and-drop design of UI screens, the GUI framework automatically generates C code that is compatible with the GUI library and ready to be compiled and run on the MCUs. GUI applications can be executed on a desktop PC within the GUI development environment, allowing quick generation and testing of UI concepts. Once completed, designs are exported as target-ready C data structures and are ready to be compiled and linked.

GUI-tools for fast development

Smart configuration tools help designers make selections on register settings with the help of graphical tools and reach C code much faster. One example is the Smart Configurator, which helps to initialize the MPU.

Renesas RZ/A HMI solution

In the following section of this white paper, we will see how the new Renesas RZ/A Software Package simplifies and accelerates camera-GUI-display implementations for Human Machine Interfaces. For each of these main components; i.e., camera, GUI and display, the RZ/A Software Package has a pre-integrated software component that allows quick and easy design steps. For easy adjustment of the camera input, there is the “SDK for Camera sample application.” For generation of an intuitive GUI, the “TES Guiliani SDK” (Software Development Kit) provides all the necessary tools, and for quick configuration of the display controller, the quick and efficient “QE for Display” can be applied. With all these tools being pre-integrated, the RZ/A Software Package significantly reduces design complexity.

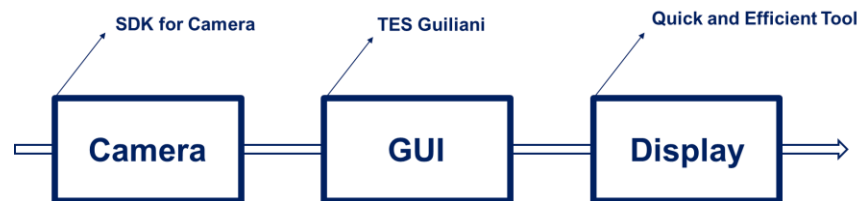

Figure 3 RZ/A Software Package removes design complexity

The RZ/A Software Package has five main components:

- RZ/A base software, including RTOS, drivers, and middleware, such as filesystem, TCP/IP stack, and USB stack
- “SDK for camera sample application” for quick camera adjustment
- Quick and efficient “QE for Display” and “QE for Camera” for graphical configuration with real-time feedback
- Several sample applications for quick application development
- Seamless integration with TES Guiliani GUI framework

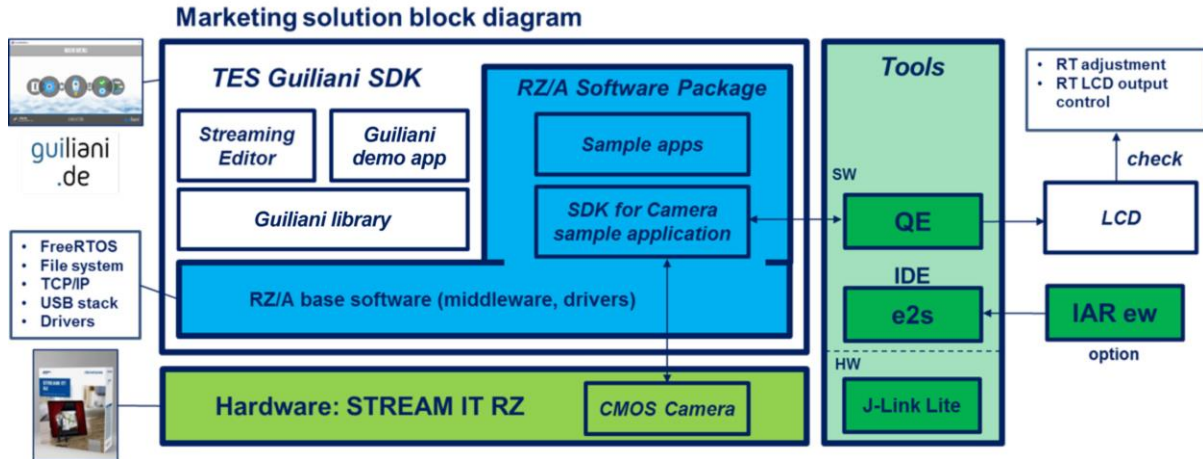

Figure 4 RZ/A Software Package components and tools

The RZ/A Software Package is currently only available for the STREAM IT! RZ hardware platform. The RZ/A Software Package is available for the Renesas e2 studio Integrated Development and IAR Embedded Workbench tools.

Hardware for RZ/A Software Package

STREAM IT! RZ solution kit

The STREAM IT! RZ solution kit (**YSTREAM-IT-RZ-V2**) is an out-of-the-box evaluation and development platform for streaming applications such as IP-based video and radio streams, as well as security applications such as video surveillance- and video/fingerprint-based access control. STREAM IT! RZ is also best suited for all kinds of web server-based applications in the home, energy and industrial automation segments. In order to enable a fast development ramp, Renesas provides several related application-specific quick start guides, complete with sample software and easy-to-follow set-up instructions.

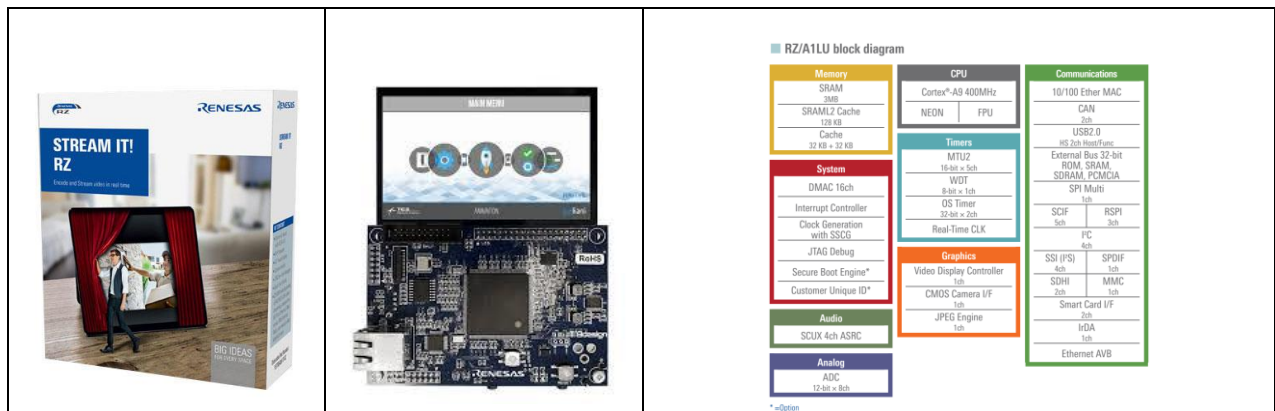

Figure 5 STREAM IT! RZ is populated with a 400MHz ARM Cortex-A9 based RZ/A1LU

The second generation of the very popular STREAM IT! RZ solution kit has been improved in four dimensions. First, STREAM IT! RZ features a much more feature-rich RZ/A embedded MPU (eMPU) called RZ/A1LU. Second, in addition to the camera module, the solution kit now comes with a touch-enabled 4.3 inch TFT-LCD (thin-film transistor liquid crystal display). Third, the related software offering, including many downloadable source code packages, has been vastly extended. And last, but not least, the eMPU main board has been enriched with additional functionality.

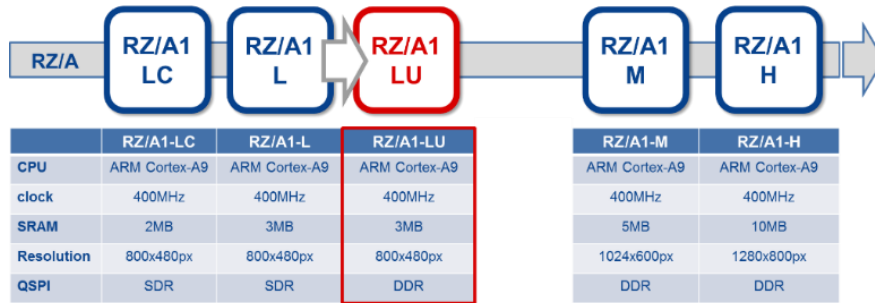

Figure 6 RZ/A1LU is part of a scalable RZ/A1 embedded MPU family

Within the RZ/A1 embedded MPU family, designers have the option to upgrade to the higher performance available on the RZ/A1M and RZ/A1H MPUs. The 10MB SRAM RZ/A1H can be evaluated on the Display it! – HMI RZ (YDISPLAY-IT-RZ).

RZ/A1 has the world’s largest embedded SRAM

The required GUI SRAM density is a function of frame count and resolution in combination with bits per pixel, which consider color depth and alpha.

Number of Images in Frame Buffer	RZ/A1L		RZ/A1M		RZ/A1H			
	4	0.6 MB	1.0 MB	4.7 MB	5.9 MB	7.3 MB	9.4 MB	
3	0.4 MB	0.7 MB	3.5 MB	4.4 MB	5.5 MB	7.0 MB	9.0 MB	
2	0.3 MB	0.5 MB	2.3 MB	2.9 MB	3.7 MB	4.7 MB	6.0 MB	7.8 MB
1	0.1 MB	0.2 MB	1.2 MB	1.5 MB	1.8 MB	2.3 MB	3.0 MB	3.9 MB
	QVGA 320x240 16bpp	WQVGA 480x272 16bpp	VGA 640x480 32bpp	WVGA 800x480 32bpp	SVGA 800x600 32bpp	WSVGA 1024x600 32bpp	XGA 1024x768 32bpp	WXGA 1280x800 32bpp

Figure 7 Required embedded SRAM as a function of frame count and color depth

Let’s say you want to execute a double-buffered HMI with WXGA resolution and 32-bits color depth. This means your memory requirement is 7.8MBs, and if you want to store this in embedded SRAM, that automatically elevates you to the RZ/A1H. You don’t have a second choice on the market to fulfill your need.

Capture Engine Unit (CEU) on RZ/A1 MPUs for image capture

The RZ/A Software Package supports video input by VDC5 or the Capture Engine Unit (CEU).

The CEU is a capture module that fetches image data externally and transfers it to the memory. The CEU is connected to the system bus via bus bridge modules and can perform the following functions:

- Image data fetch (captures an image output from an external module and writes YCbCr data to memory),
- Filter processing (performs scale-down and removal of high-frequency components),
- Format conversion (converts image data input in the YCbCr422 format into the YCbCr420 format).

RZ/A architecture with its 5x AXI bus and five SRAM pages efficiently removes data bottlenecks in HMI applications.

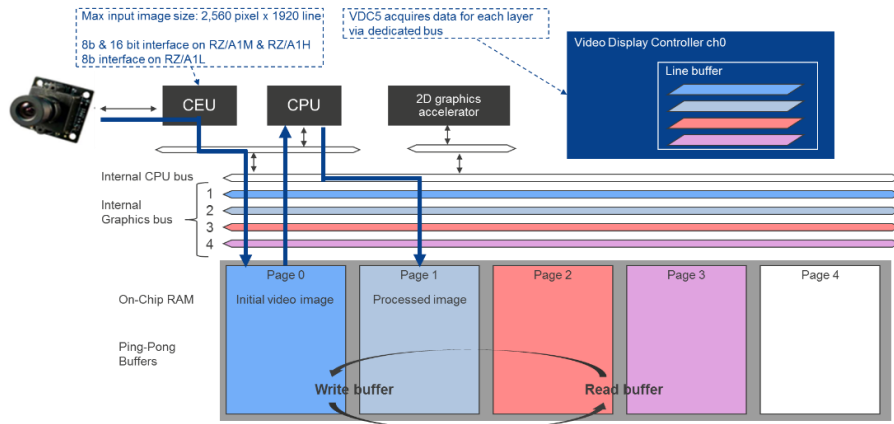

Figure 8 Image capture with CEU and data push to SRAM and VDC

Video Display Controller 5 (VDC5) on RZ/A1 MPUs

Members of the RZ/A1 embedded MPU family incorporate the very powerful VDC5 Video Display Controller. The RZ/A1LU embedded MPU, which is populated on the STREAM IT! RZ, has one VDC5 channel; the RZ/A1M and RZ/A1H have two VDC5 channels.

The VDC5 consists of the following six blocks:

1. Input controller: Input video image selection, sync signal adjustment, horizontal noise reduction, and brightness adjustment, gain adjustment, and YCbCr to GBR conversion using a color matrix
2. Scaler: Scale up, scale down, and rotation of input video images using the frame buffer, and repeated recording of the specified number of fields in the frame buffer
3. Image quality improver: Black stretch, LTI/sharpness, and YCbCr to GBR conversion using a color matrix
4. Image synthesizer: Synthesis of one plane of video image plus two graphics planes, or three graphics planes
5. Output controller: Brightness/contrast adjustment, gamma correction, dither processing, output format conversion, and control signal output for TFT-LCD panel
6. System controller: Interrupt control, panel clock control, and CLUT table select signal status flag output.

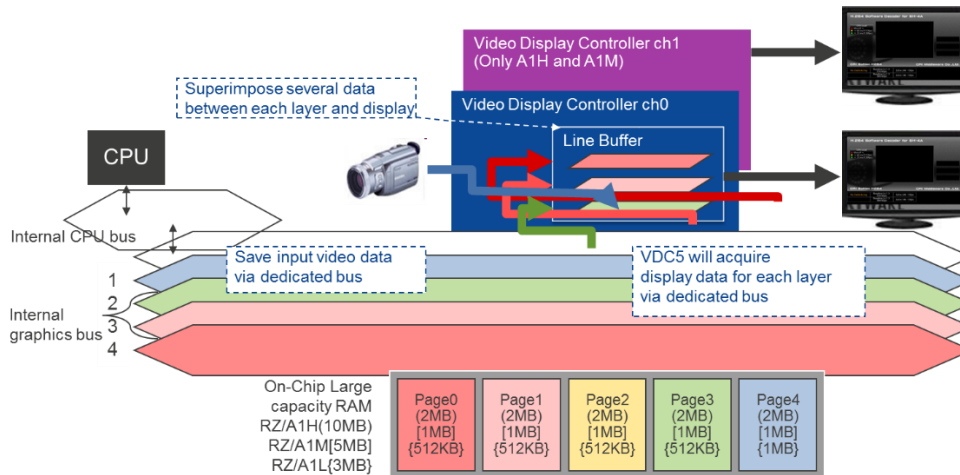

Figure 9 Video and image subsystem of RZ/A1 MPUs

Interestingly, VDC5, which is the RZ/A1's display controller, cannot only perform video display functions, but also video input functions, including image adjustment, image scaling and rotation, and more.

RZ/A Software Package: “SDK for Camera Sample Application” and “QE for Display”

“SDK for Camera Sample Application”, “QE for Display/Camera”, and VDC5 work in combination to accelerate camera and display optimization. The “SDK for Camera” is a sample application program for cameras that supports functionality to capture an image from the camera, adjust the image, and display the adjusted image. After image data is adjusted, the application software can obtain the data which can be subjected to image processing by software (such as recognition processing and JPEG compression).

QE for Display

“QE for Display” can be launched directly from e2 studio's IDE. The above mentioned image-adjustment options are available immediately after launch from the QE tool. The picture below shows the VDC5 block diagram and how the user can track the image data flow between camera input and display output. Also, the user can follow the positional relationship of various image correction procedures.

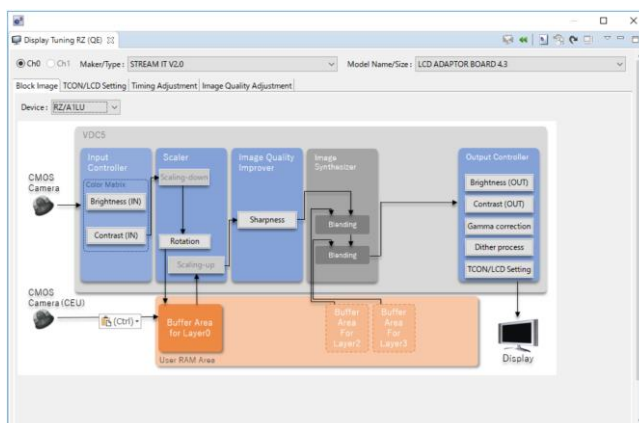

Figure 10 VDC5-based image adjustments with QE Tool

With “QE for Display”, image adjustments for brightness, contrast, rotation, gamma correction, and dither are literally only one mouse click away and viewable in real-time on the display without recompiling. Also, with “QE for Display”, output timing settings can be easily adjusted over the GUI-based configuration tool and stored in a header file.

Sample Applications

In addition to the RZ/A Software Package, Renesas offers a list of sample applications for RZ/A designers. With these sample applications, RZ/A designers possess the quickest start as they can select a ready project that is close to their target use case. Ready sample applications include the Guiliani demo, “SDK for Camera Sample Application”, and GUI, touch panel, web server, USB host, USB function, ADC, and sound samples.

TES Guiliani GUI framework

TES' Guiliani is a platform-independent HMI framework designed to meet today's user expectations for smartphone-like HMIs on highly cost-driven embedded systems. Guiliani allows the effective parallelization of required work types, such as artistic design, interaction design, and application-logic programming. Guiliani is delivered with a customizable and extendible set of modern widgets and features such as carousels, wheels, gauges, animations, transition effects, multi-language support, and skinning. Per default, applying modern graphics-processing features like sub-pixel accurate rendering, anti-aliasing, scaling, filtering, and blending in combination with smart redraw and caching mechanisms leads to an eye-catching and high-performance visual experience. The Guiliani Streaming Editor, “GSE”, a WYSIWYG PC editor and builder with integrated simulator, supports rapid HMI design and prototyping, resulting in fast development cycles.

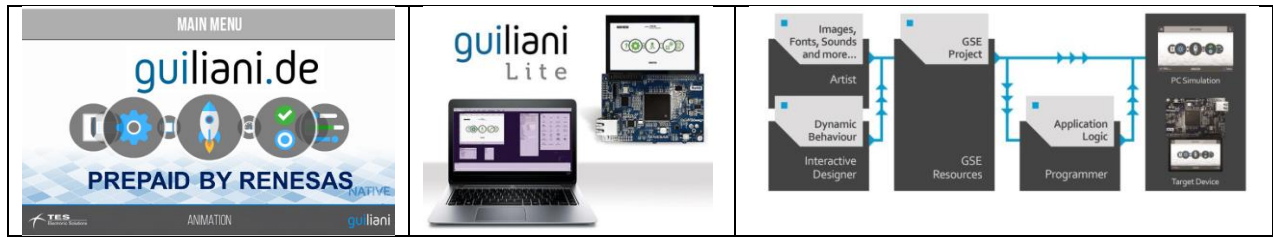

Figure 11 TES Guiliani GUI framework (available free of charge for RZ/A designers)

Based on its concept and architecture, powerful software rendering engine, and resource management capabilities, Guiliani is an ideal match with the Renesas RZ/A MPU family. With the V2.2 update, more specific BLIT operations have been included that are optimized for dedicated HMI use-cases.

Integrated Development Environment

e2 studio is an Eclipse-based development environment with a comprehensive set of tools and plug-in features such as intuitive configuration, error and format checking, and code generation to accelerate development.

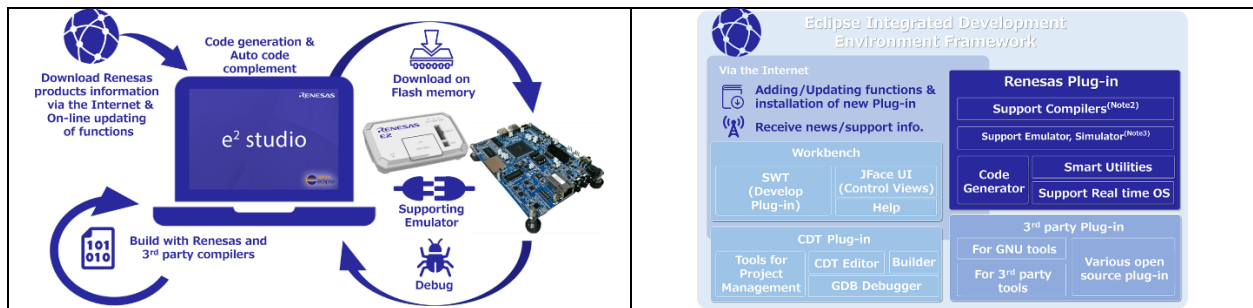

Figure 12 e2 studio Integrated Development Environment by Renesas

The second Integrated Development Environment that can be used with the RZ/A Software Package is the IAR Embedded Workbench, which includes an optimized compiler, code analysis tools such as C-STAT® and C-RUN®, and deep RTOS-aware debugging.

Conclusion

Speed up development with Renesas RZ/A HMI Design Tools

Working with the RZ/A Software Package, you literally jumpstart your industrial HMI development. First, you save time by working with the STREAM IT! RZ hardware development platform, which has all you need from a hardware perspective – a powerful MPU with 3MB of embedded SRAM, a 4.3inch touch TFT display, and a connected camera. The RZ/A Software Package is fully integrated and free of charge. It comes with several sample applications that allow a very quick ramp to innovation, and it is fully integrated with the highly differentiated TES Guiliani GUI framework. With the TES Guiliani-Lite PREPAID program, this package is also free of charge, even in production.

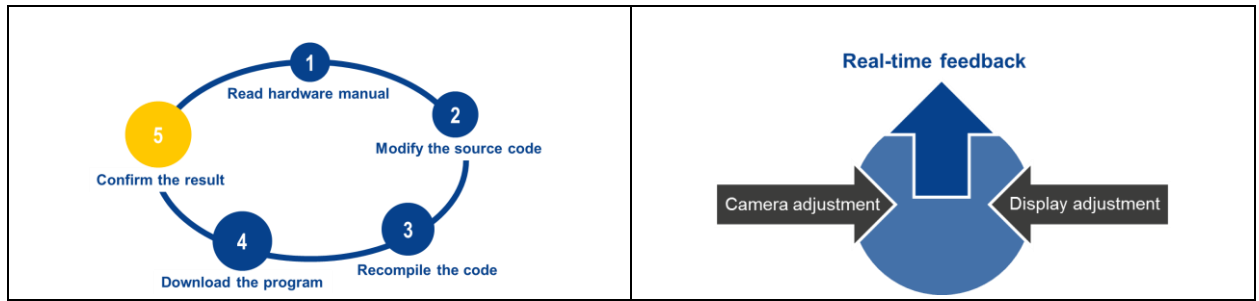

Figure 13/14 RZ/A Software Package speeds up development of HMIs (left: Conventional; right: RZ/A SW Package)

In a conventional development cycle, designers start by reading bulky hardware manuals, which may have thousands of pages. Hardware for HMI implementations tend to have a fair amount of complexity. As an example, the VDC5 video display controller has over 2,000 registers. Subsequently, the designer would adjust the source code, recompile the code, download the program, and confirm the result. And this entire cycle would take place many times until the target outcome is reached. With “Camera SDK Sample Application” and “QE for Display”, camera and display adjustments are configured graphically, and the result is monitored in real time without any source code changes or recompilations.

© 2018 Renesas Electronics America Inc. (REA). All rights reserved. All trademarks and trade names are those of their respective owners. REA believes the information herein was accurate when given but assumes no risk as to its quality or use. All information is provided as-is without warranties of any kind, whether express, implied, statutory, or arising from course of dealing, usage, or trade practice, including without limitation as to merchantability, fitness for a particular purpose, or non-infringement. REA shall not be liable for any direct, indirect, special, consequential, incidental, or other damages whatsoever, arising from use of or reliance on the information herein, even if advised of the possibility of such damages. REA reserves the right, without notice, to discontinue products or make changes to the design or specifications of its products or other information herein. All contents are protected by U.S. and international copyright laws. Except as specifically permitted herein, no portion of this material may be reproduced in any form, or by any means, without prior written permission from Renesas Electronics America Inc. Visitors or users are not permitted to modify, distribute, publish, transmit or create derivative works of any of this material for any public or commercial purposes.