

ISL29112

Low Power, <100 Lux Optimized, Analog Output Ambient Light Sensor

FN8836
Rev.1.00
May 8, 2017

The [ISL29112](#) is a low cost, light-to-voltage silicon optical sensor combining a photodiode array, a non-linear current amplifier, and a micropower op amp on a single monolithic IC. Similar to the human eye, the photodiode array has peak sensitivity at 550nm and spans the wavelength range 400nm to 600nm, rejecting UV and IR light. The input luminance range is from 0.01 lux to 100 lux.

The integrated non-linear current amplifier boosts and converts the photodiode signal into a square root output format, extending dynamic range while maintaining excellent sensitivity in dimly lit conditions. As such, the part is ideal for measuring incident daylight when mounted behind heavily smoked bezels used around displays or behind mirrors.

The device consumes minimum power. A dark current compensation circuit minimizes the effect of temperature dependent leakage currents in the absence of light, improving the light sensitivity at low lux levels. The output gain has been optimized to require a relatively low value external bias resistor that falls within recommended automotive EMI limits. The built-in 1µA op amp gives the ISL29112 an output voltage driving advantage for heavier loads that can drive an ADC directly.

The ISL29112 is housed in an ultra compact 2mmx2.1mm ODFN plastic surface mount package. Operation is rated from -40°C to +85°C.

Features

- Square root voltage output
- 0.01 lux to 100 lux range
- 1.8V to 3V supply range
- Close to human eye spectral response
- Fast response time
- Internal temperature compensation
- Good IR rejection
- Low supply current
- Operating temperature range -40°C to +85°C
- 6 Ld ODFN: 2mmx2.1mmx0.7mm
- Pb-free (RoHS compliant)

Applications

- Mobile devices: wearables, smart phone, PDA, GPS
- Computing devices: notebook PC, MacBook, tablets
- Consumer devices: LCD-TV, digital camera
- Industrial, home automation and medical light sensing

Related Literature

- For a full list of related documents, visit our website - [ISL29112](#) product page

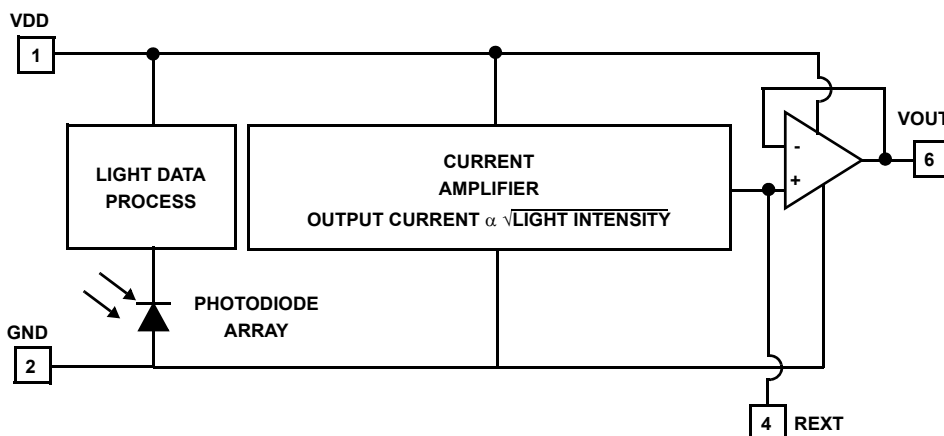
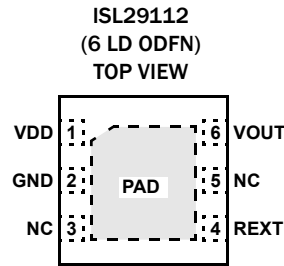

FIGURE 1. SIMPLIFIED BLOCK DIAGRAM

Pin Configuration



Pin Descriptions

PIN NUMBER	PIN NAME	PIN DESCRIPTION
1	VDD	Voltage Supply (1.8V to 3V).
2	GND	Ground
3, 5	NC	No connect
4	REXT	Connected to an external resistor to GND, setting the light-to-voltage scaling constant. A R_{EXT} value of 100k Ω is recommended.
6	VOUT	Voltage Output.
-	PAD	Thermal Pad. The thermal pad can be connected to GND or electrically isolated.

Ordering Information

PART NUMBER (Notes 1, 2, 3)	TAPE AND REEL (UNITS)	PACKAGE (RoHS Compliant)	PKG. DWG. #
ISL29112IROZ-T7	3k	6 Ld ODFN	L6.2x2.1
ISL29112IROZ-T7A	250	6 Ld ODFN	L6.2x2.1
ISL29112IROZ-EVALZ	Evaluation Board		

NOTES:

- Please refer to [TB347](#) for details on reel specifications.
- These Intersil Pb-free plastic packaged products employ special Pb-free material sets; molding compounds/die attach materials and NiPdAu plate -e4 termination finish, which is RoHS compliant and compatible with both SnPb and Pb-free soldering operations. Intersil Pb-free products are MSL classified at Pb-free peak reflow temperatures that meet or exceed the Pb-free requirements of IPC/JEDEC J STD-020.
- For Moisture Sensitivity Level (MSL), see product information page for [ISL29112](#). For more information on MSL please see techbrief [TB477](#).

Absolute Maximum Ratings ($T_A = +25^\circ\text{C}$)

Supply Voltage Between VDD and GND	3.6V
REXT	(-0.5V + GND) to (0.5V + VDD)
VOUT	(-0.5V + GND) to (0.5V + VDD)
VOUT Short-Circuit Current	<10mA
ESD Rating	
Human Body Model (Tested per JESD22-A114E)	2kV

Thermal Information

Thermal Resistance (Typical)	θ_{JA} ($^\circ\text{C}/\text{W}$)	θ_{JC} ($^\circ\text{C}/\text{W}$)
6 Ld ODFN (Notes 4, 5)	88	7.94
Maximum Die Temperature	+90 $^\circ\text{C}$	
Storage Temperature	-40 $^\circ\text{C}$ to +100 $^\circ\text{C}$	
Operating Temperature	-40 $^\circ\text{C}$ to +85 $^\circ\text{C}$	
Pb-Free Reflow Profile	see TB487	

CAUTION: Do not operate at or near the maximum ratings listed for extended periods of time. Exposure to such conditions may adversely impact product reliability and result in failures not covered by warranty.

NOTES:

- θ_{JA} is measured in free air with the component mounted on a high-effective thermal conductivity test board with “direct attach” features. See Tech Brief [TB379](#).
- For θ_{JC} , the “case temp” location is the center of the exposed metal pad on the package underside.

Electrical Specifications Unless otherwise noted, all parameter limits are established across the recommended operating conditions: $V_{DD} = 3\text{V}$, $T_A = -40^\circ\text{C}$ to $+85^\circ\text{C}$, $R_{EXT} = 100\text{k}\Omega$, no load at V_{OUT} and green LED light. (Typical values are at $T_A = +25^\circ\text{C}$). **Boldface limits apply across the operating temperature range, -40 $^\circ\text{C}$ to +85 $^\circ\text{C}$.**

PARAMETER	SYMBOL	TEST CONDITIONS	MIN (Note 6)	TYP	MAX (Note 6)	UNIT
Range of Input Light Intensity for Square Root Relationship to be Held	E			0.01 - 100		lux
Operating Supply Voltage	V_{DD}		1.8		3	V
Supply Current	I_{DD}	E = 0 lux, -40 $^\circ\text{C}$ to +60 $^\circ\text{C}$		0.7	2	μA
		E = 100 lux		23	35	μA
Light-to-Voltage Accuracy	V_{OUT}	E = 10 lux		0.65		V
		E = 50 lux		1.35		V
		E = 100 lux	1.40	1.85	2.30	V
Voltage Output in the Absence of Light	V_{DARK}	E = 0 lux, -40 $^\circ\text{C}$ to +60 $^\circ\text{C}$		0.95	20	mV
Output Voltage Variation Over Three Light Sources: Fluorescent, Incandescent and Halogen	ΔV_{OUT}			10		%
Power Supply Rejection Ratio	PSRR	E = 100 lux		0.12		mV/V
Maximum Output Compliance Voltage at 95% of Nominal Output	V_{O-CMPL}			$V_{DD} - 0.7\text{V}$		V
Maximum Output Voltage Swing	V_{O-MAX}				V_{DD}	V
Rise Time	t_R	E = 0 lux to 100 lux		95		μs
Fall Time	t_F	E = 100 lux to 0 lux		155		μs
Delay Time for Rising Edge	t_D	E = 0 lux to 100 lux		350		μs
Delay Time for Falling Edge	t_S	E = 100 lux to 0 lux		250		μs
Short-Circuit Current of Op Amp	I_{SC}			± 12		mA
Slew Rate of Op Amp	S_R			13		V/ms
Offset Voltage of Op Amp	V_{OS}			± 0.9		mV

NOTE:

- Parameters with MIN and/or MAX limits are 100% tested at $+25^\circ\text{C}$, unless otherwise specified. Temperature limits established by characterization and are not production tested.

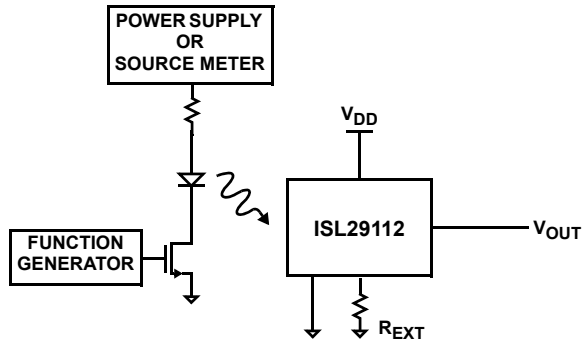

FIGURE 2. TEST CIRCUIT FOR RISE/FALL TIME MEASUREMENT

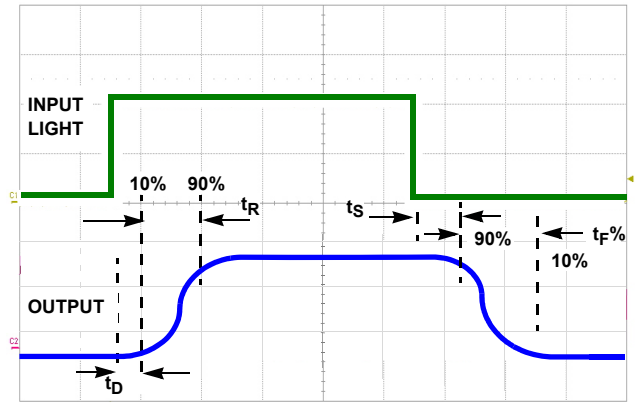

FIGURE 3. TIMING DIAGRAM

Typical Performance Curves

$V_{DD} = 3V$, $T_A = +25^\circ C$, $R_{EXT} = 100k\Omega$, no load at V_{OUT} , green LED light,

unless otherwise specified.

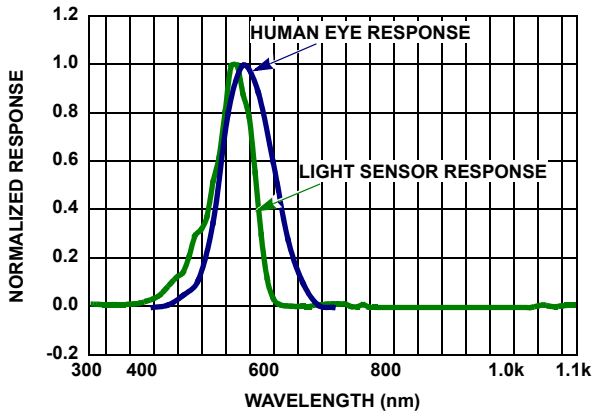

FIGURE 4. SPECTRAL RESPONSE

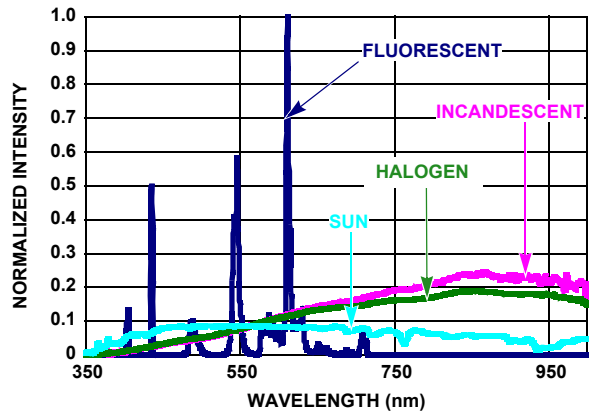

FIGURE 5. SPECTRUM OF FOUR LIGHT SOURCES NORMALIZED BY LUMINOUS INTENSITY (lux)

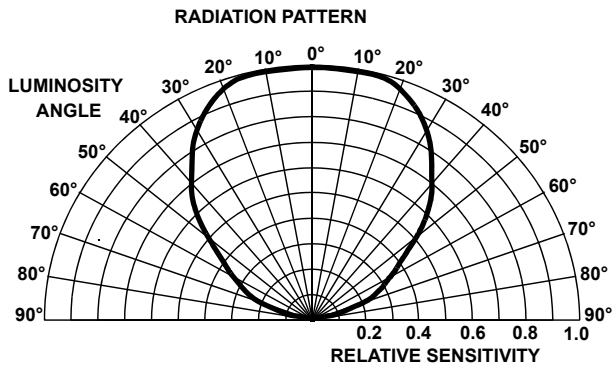

FIGURE 6. RADIATION PATTERN

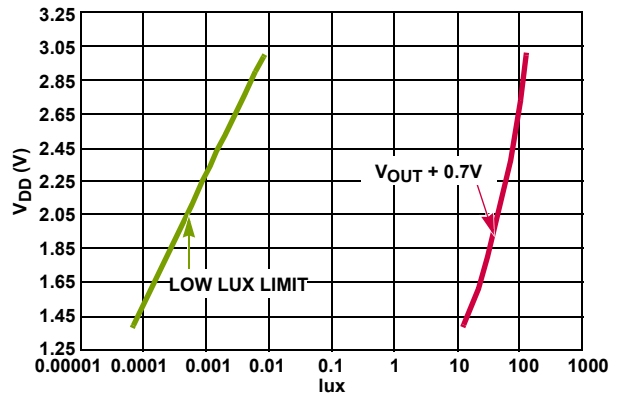

FIGURE 7. V_{DD} OPERATING RANGE (WHITE LED)

Typical Performance Curves

$V_{DD} = 3V$, $T_A = +25^\circ C$, $R_{EXT} = 100k\Omega$, no load at V_{OUT} , green LED light, unless otherwise specified. (Continued)

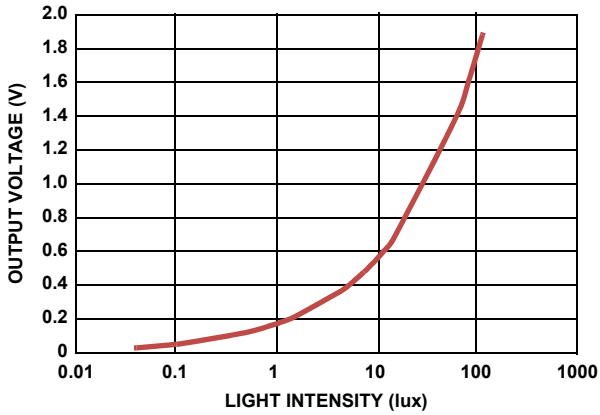

FIGURE 8. OUTPUT VOLTAGE vs LIGHT INTENSITY 0.1 lux TO 100 lux

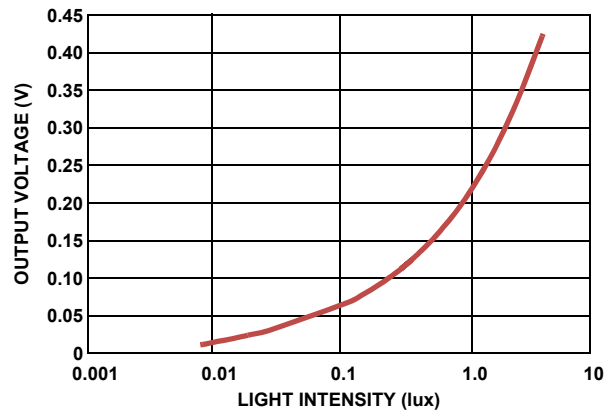

FIGURE 9. OUTPUT VOLTAGE vs LIGHT INTENSITY 0.01 lux TO 5 lux

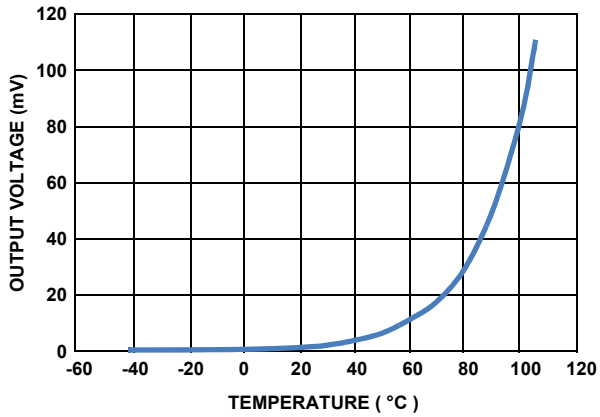

FIGURE 10. OUTPUT VOLTAGE vs TEMPERATURE AT 0 lux

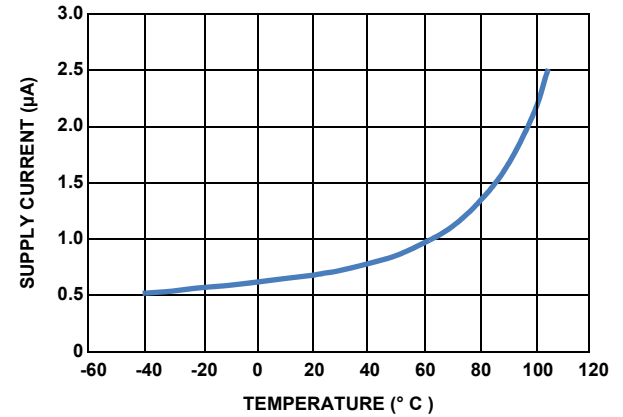

FIGURE 11. SUPPLY CURRENT vs TEMPERATURE AT 0 lux

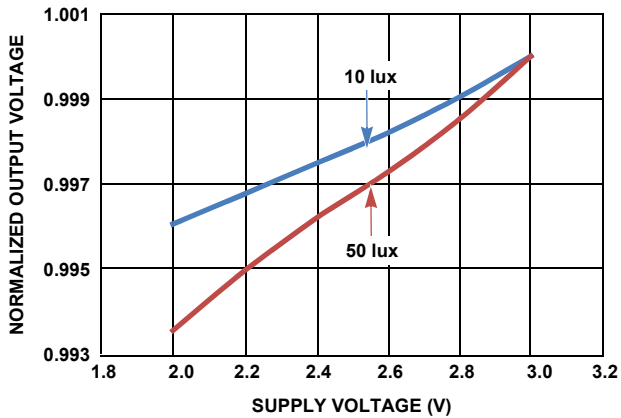

FIGURE 12. NORMALIZED OUTPUT VOLTAGE vs SUPPLY VOLTAGE

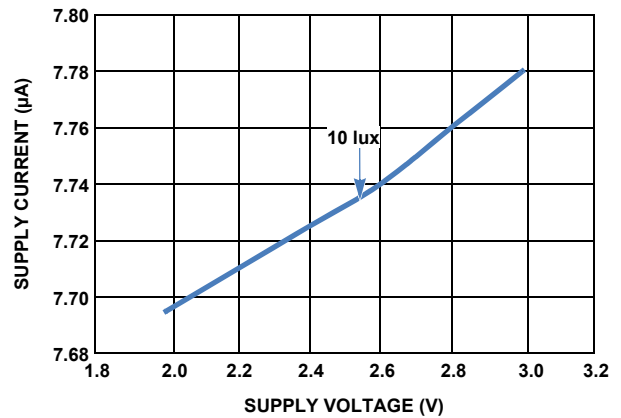

FIGURE 13. SUPPLY CURRENT vs SUPPLY VOLTAGE

Typical Performance Curves

$V_{DD} = 3V$, $T_A = +25^\circ C$, $R_{EXT} = 100k\Omega$, no load at V_{OUT} , green LED light, unless otherwise specified. (Continued)

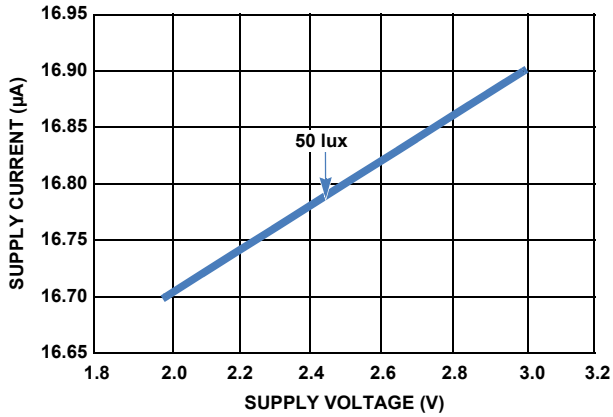

FIGURE 14. SUPPLY CURRENT vs SUPPLY VOLTAGE

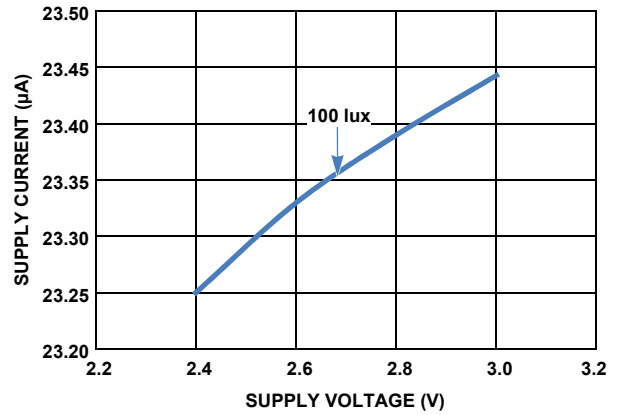

FIGURE 15. SUPPLY CURRENT vs SUPPLY VOLTAGE

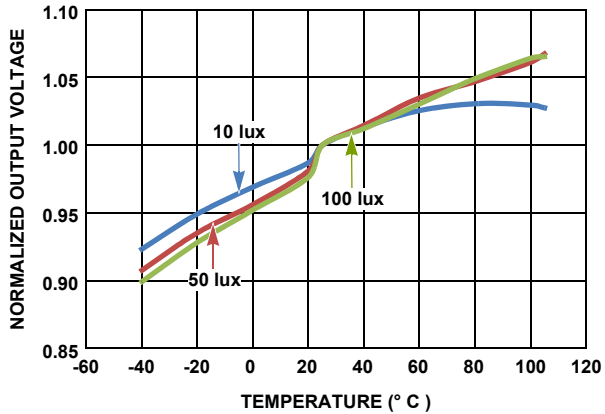

FIGURE 16. NORMALIZED OUTPUT VOLTAGE vs TEMPERATURE

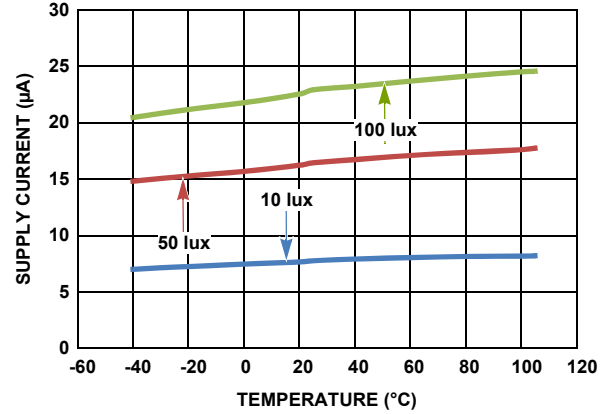

FIGURE 17. SUPPLY CURRENT vs TEMPERATURE

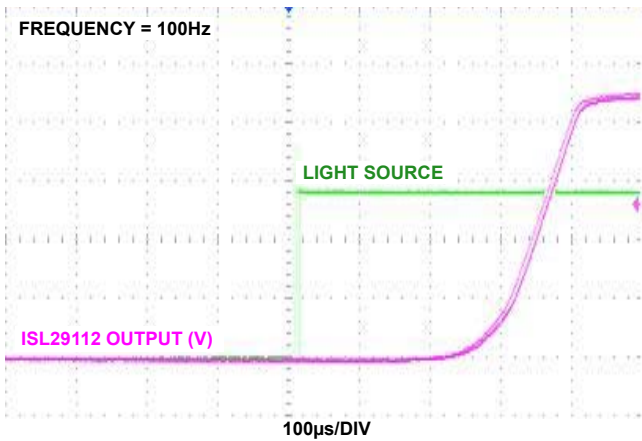

FIGURE 18. DELAY TIME vs LUX CHANGE FROM 0 lux

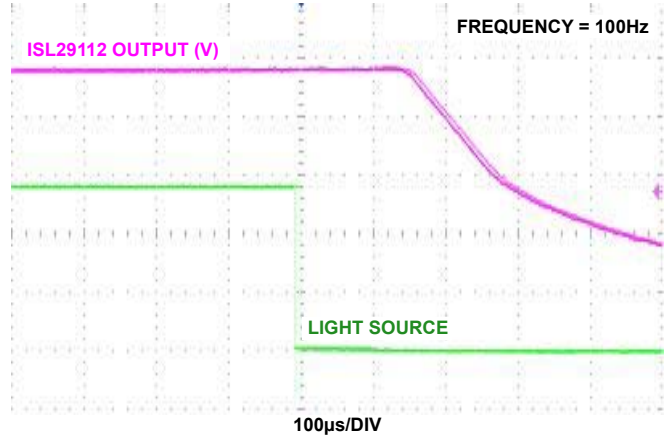

FIGURE 19. DELAY TIME vs LUX CHANGE TO 0 lux

Application Information

Light-to-Voltage Conversion

The ISL29112 has responsiveness that is a square root function of the light intensity intercepted by the photodiode in lux.

Because the photodiode has a responsivity that resembles the human eye, conversion rate is independent of the light source (fluorescent light, incandescent light or direct sunlight).

$$V_{OUT} = \frac{18\mu A}{\sqrt{100\text{lux}}} \sqrt{E} \times R_{EXT} \quad (\text{EQ. 1})$$

In [Equation 1](#), V_{OUT} is the output voltage, E is the light intensity, and R_{EXT} is the value of the external resistor. The R_{EXT} is used to set the light-to-voltage scaling constant. The compliance of the ISL29112's output circuit may result in premature saturation when an excessively large R_{EXT} is used. A R_{EXT} value of 100k Ω is recommended for automotive applications. The output compliance voltage is 700mV below the supply voltage as listed in V_{O-MAX} of the "Electrical Specifications" table on [page 3](#).

Optical Sensor Location Outline

The green area in [Figure 20](#) shows the optical sensor location outline of ISL29112. Along the pinout direction, the Center Line (CL) of the sensor coincides with that of the packaging. The sensor width in this direction is 0.39mm. Perpendicular to the pinout direction, the CL of the sensor has an 0.19mm offset from the CL of packaging away from Pin 1. The sensor width in this direction is 0.46mm.

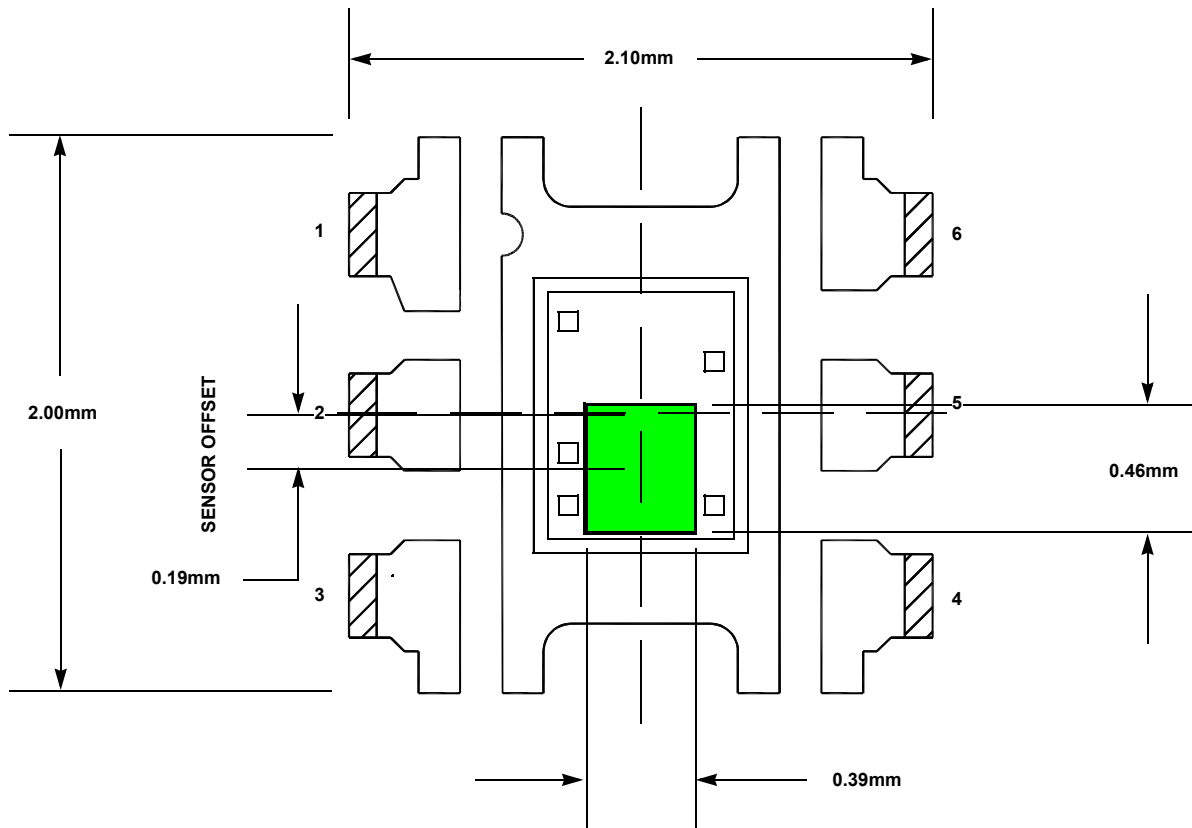

FIGURE 20. 6 LD ODFN SENSOR LOCATION OUTLINE

Revision History The revision history provided is for informational purposes only and is believed to be accurate, but not warranted. Please visit our website to make sure you have the latest revision.

DATE	REVISION	CHANGE
May 8, 2017	FN8836.1	Ordering Information table on page 2: Added ISL29112IROZ-T7A and replaced ISL76671EVAL1Z with ISL29112IROZ-EVALZ.
Apr 1, 2016	FN8836.0	Initial Release

About Intersil

Intersil Corporation is a leading provider of innovative power management and precision analog solutions. The company's products address some of the largest markets within the industrial and infrastructure, mobile computing and high-end consumer markets.

For the most updated datasheet, application notes, related documentation and related parts, please see the respective product information page found at www.intersil.com.

For a listing of definitions and abbreviations of common terms used in our documents, visit www.intersil.com/glossary.

You may report errors or suggestions for improving this datasheet by visiting www.intersil.com/ask.

Reliability reports are also available from our website at www.intersil.com/support.

© Copyright Intersil Americas LLC 2016-2017. All Rights Reserved.
All trademarks and registered trademarks are the property of their respective owners.

For additional products, see www.intersil.com/en/products.html

Intersil products are manufactured, assembled and tested utilizing ISO9001 quality systems as noted in the quality certifications found at www.intersil.com/en/support/qualandreliability.html

Intersil products are sold by description only. Intersil may modify the circuit design and/or specifications of products at any time without notice, provided that such modification does not, in Intersil's sole judgment, affect the form, fit or function of the product. Accordingly, the reader is cautioned to verify that datasheets are current before placing orders. Information furnished by Intersil is believed to be accurate and reliable. However, no responsibility is assumed by Intersil or its subsidiaries for its use; nor for any infringements of patents or other rights of third parties which may result from its use. No license is granted by implication or otherwise under any patent or patent rights of Intersil or its subsidiaries.

For information regarding Intersil Corporation and its products, see www.intersil.com

Package Outline Drawing

For the most recent package outline drawing, see [L6.2x2.1](#).

L6.2x2.1

6 LEAD OPTICAL DUAL FLAT NO-LEAD PLASTIC PACKAGE (ODFN)

Rev 4, 2/15

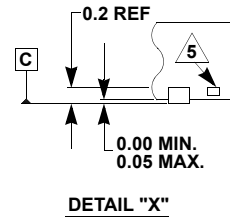
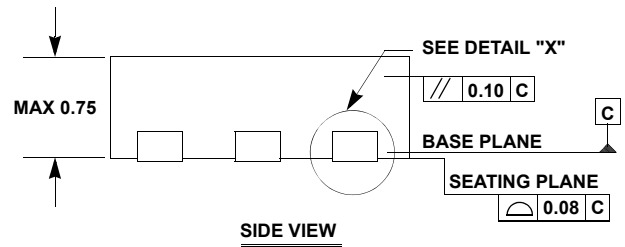
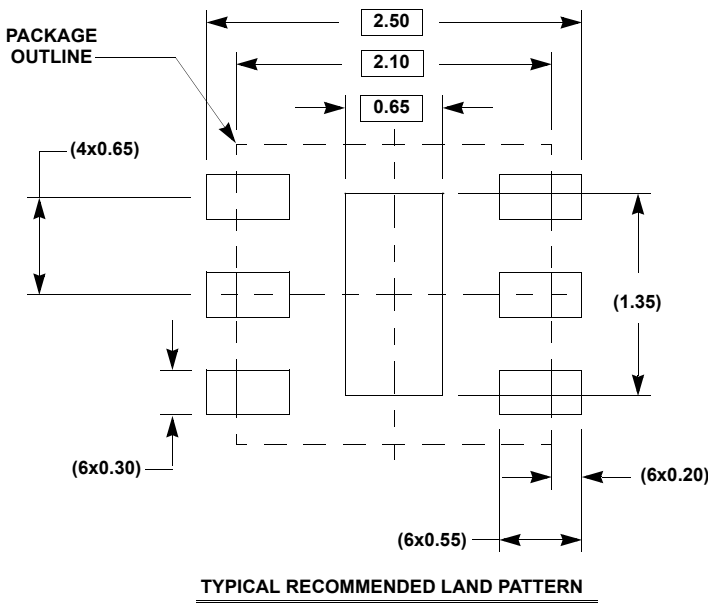
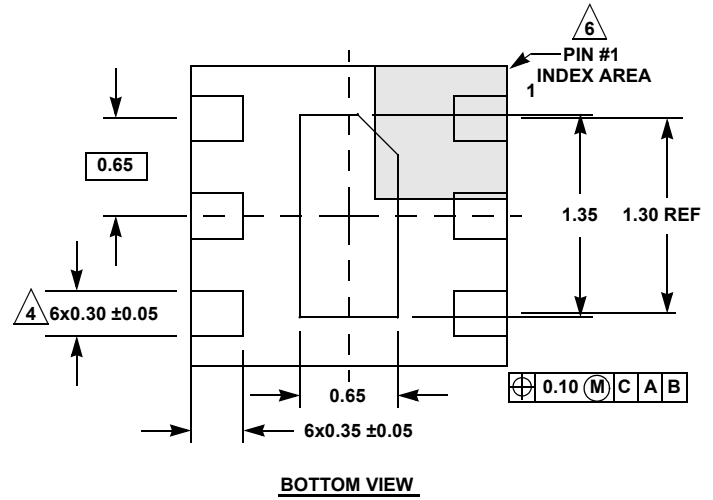
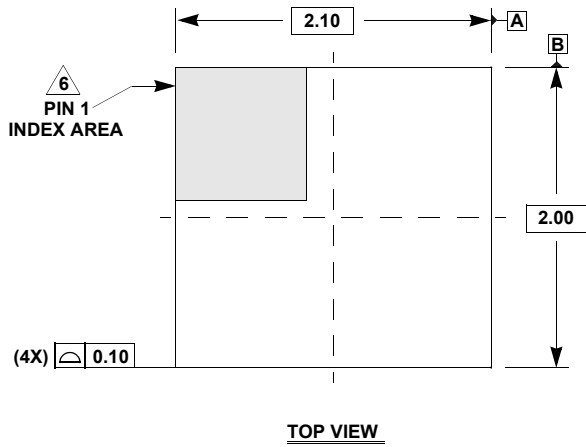

NOTES:

1. Dimensions are in millimeters.
Dimensions in () for Reference Only.
2. Dimensioning and tolerancing conform to ASME Y14.5m-1994.
3. Unless otherwise specified, tolerance: Decimal ± 0.05
4. Dimension applies to the metallized terminal and is measured between 0.15mm and 0.30mm from the terminal tip.
5. Tiebar shown (if present) is a non-functional feature and maybe located on any of the 4 sides (or ends).
6. The configuration of the pin #1 identifier is optional, but must be located within the zone indicated. The pin #1 identifier may be either a mold or mark feature.