



Technical Data of Ceramic Resonator

MURATA Part No.: CSTCR4M00G55Z-R0

Applied to R5F21356ANFP;CM11=0

TOYAMA MURATA MANUFACTURING CO., LTD.

Engineering Section IV
Piezoelectric Components Department I
Piezoelectric Components Division
Device Business Unit

Approved by	Checked by	Issued by	Issued Date	Data No.
 K.Maruno	 R.Miyamae	 T.Morita	Apr 11, 2008	TCD-08-0614

Contents

1.	Test Circuit	1
2.	Temperature Characteristics of Oscillating Frequency, Oscillating Voltage	2
3.	Rise Time, Oscillating Frequency, Oscillating Voltage vs Vcc Characteristics	3
4.	Oscillating Frequency, Oscillating Voltage, Rise Time, Starting Voltage vs Rd Characteristics	4

Note : Rise Time

We define "Rise time" is the time while the oscillation amplitude (V_{pp}) reaches 90% of it at steady condition after Vdd(Vset) is supplied.

「Rise time」はVdd(Vset)が供給されてから発振電圧が最大電圧の90%に達するまでの時間と定義しています。

<General start up wave form> <標準的な発振立上り波形>

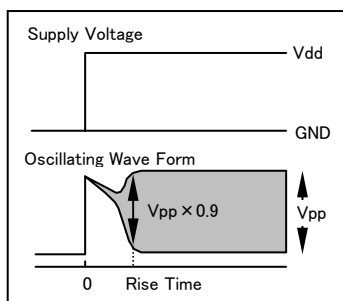

In general, Ceramic resonator is able to rise up during several microseconds to a hundred microseconds, and it is shorter than usual X'tal resonator that is able to rise up around several millisecond.

However, a rise time will be longer due to a longer rise time of Vdd(Vset) caused by a bypass capacitor.

This is because a rise time of resonator is affected by a rise time of Vdd(Vset).

In other case, rise up time will be also long if supply voltage to the oscillation circuit takes a certain time by reset time etc. after Vdd(Vset) is supplied.

Add to this, we can not measure rise time more than dozens of seconds due to measurement system. In this case, we will discribe "Unable to measure" in rise time data area.

一般にセラミック発振器そのものによる立ち上がり時間は水晶が数msecであるのに対して数u~百usec程度と非常に早いものとなっております。

しかしながら、バイパスコンデンサの影響により、発振器の立ち上がり時間に比べてVdd(Vset)の立ち上がり時間が遅くなる場合、発振器の立上り時間も

Vdd(Vset)の立上り時間に依存しているため遅くなります。

Vdd(Vset)が供給されたあと、リセット時間等により、発振回路へ電圧が供給されるまでに一定時間かかる場合も同様に、発振器の立上り時間が遅くなります。

なお、測定器の都合により、数十秒以上の立ち上がり時間は測定不可となりますので、その場合は「Unable to measure」と記載しています。

<Start up wave form with bypass capacitor>

<バイパスコンデンサによる影響>

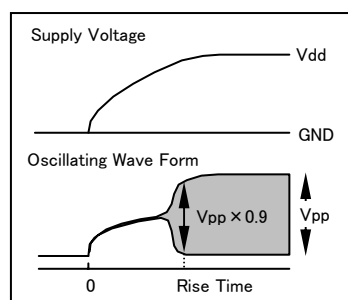

<Start up wave form with Reset function IC>

<リセット機能による影響>

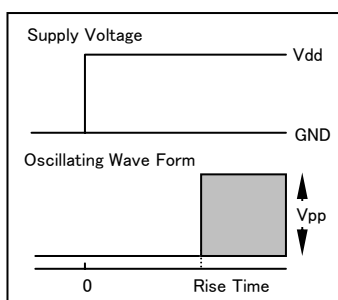

Test Circuit

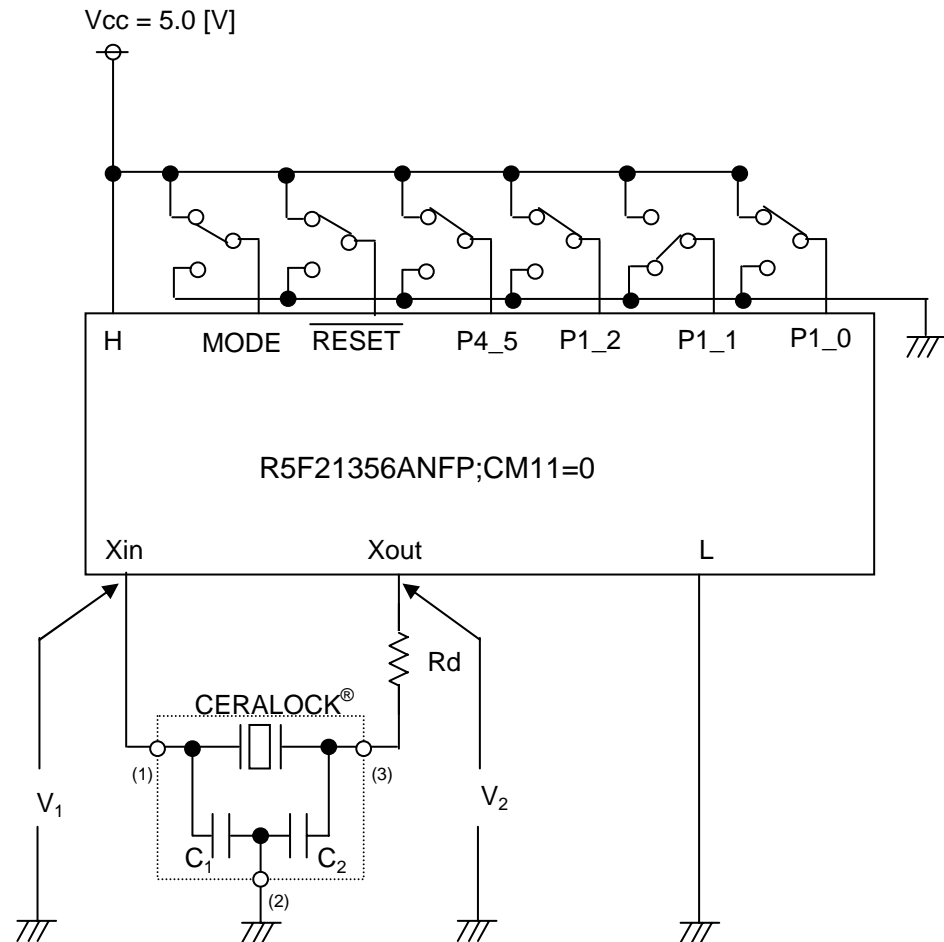

Xin : 11 MODE: 5
 Xout: 9 RESET: 8
 H : 2,7 P4_5: 30
 L : 5 P1_2: 36
 P1_1: 37
 P1_0: 38

MODE	L→H
RESET	L→H
P4_5	L→H
P1_2	OPEN→H
P1_1	OPEN→L

CM11はシステムクロック制御レジスタ1のXIN-XOUT内蔵帰還抵抗選択ビットを示します。
 "CM11" shows "XIN-XOUT on-chip feedback resistor select bit" of System Clock Control Resistor 1.
 本データは、CM11=0:内蔵帰還抵抗が有効状態で測定を実施しております。
 This Data is measured in CM11=0:On-chip feedback resistor enabled.

Recommended Value

CERALOCK[®] : CSTCR4M00G55Z-R0

Vcc = 1.8 to 5.5 [V]

C1 = 39 [pF] (Typ.)

C2 = 39 [pF] (Typ.)

Rd = 680 [ohm]

Ta = -40 to 85 [°C]

* (1)(2)(3)はピン番号を表します。詳しくは弊社仕様書またはカタログをご参照ください。

* (1),(2) and (3) means terminal number of resonator. Please see its specification or datasheet in detail.

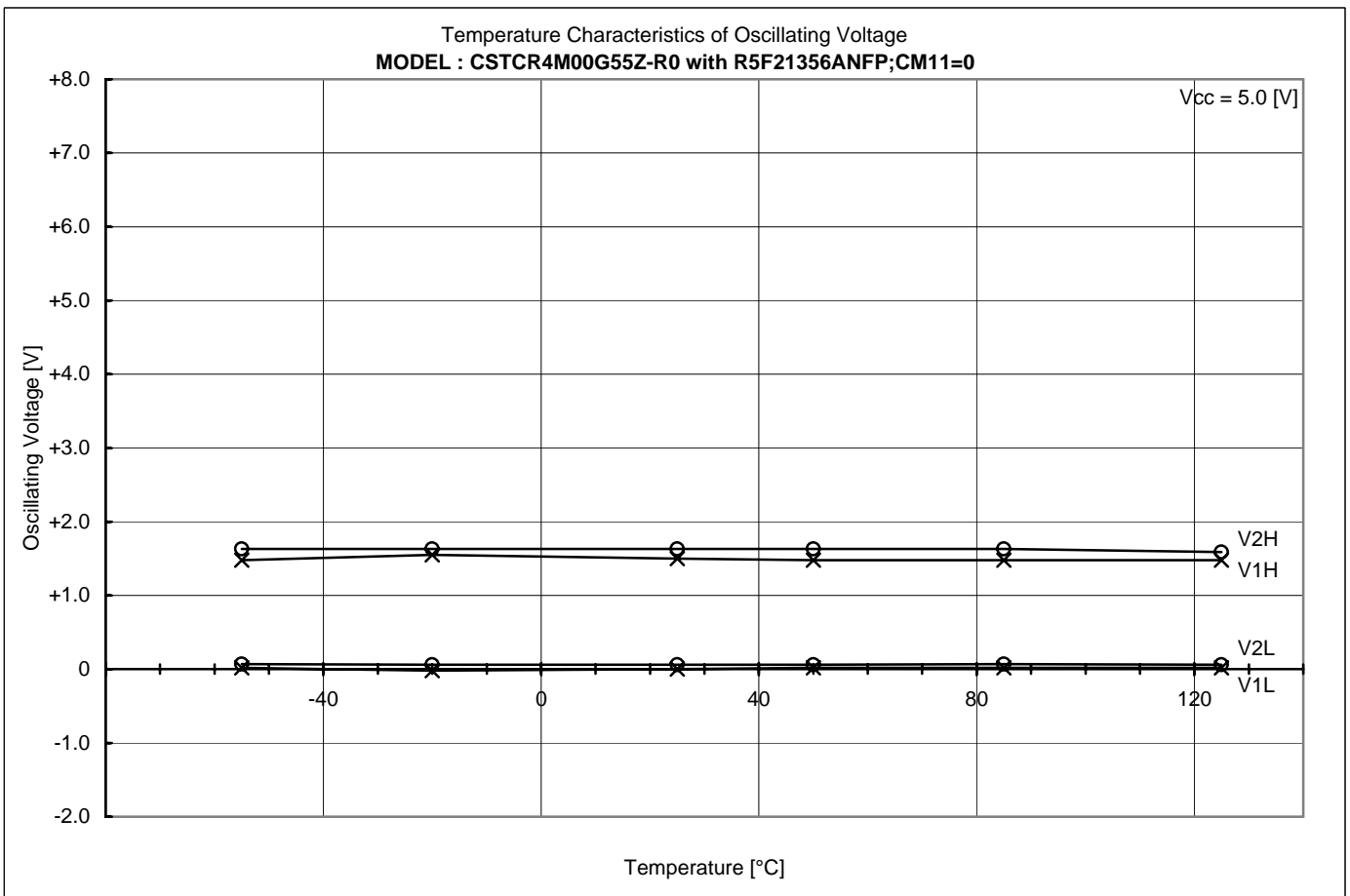
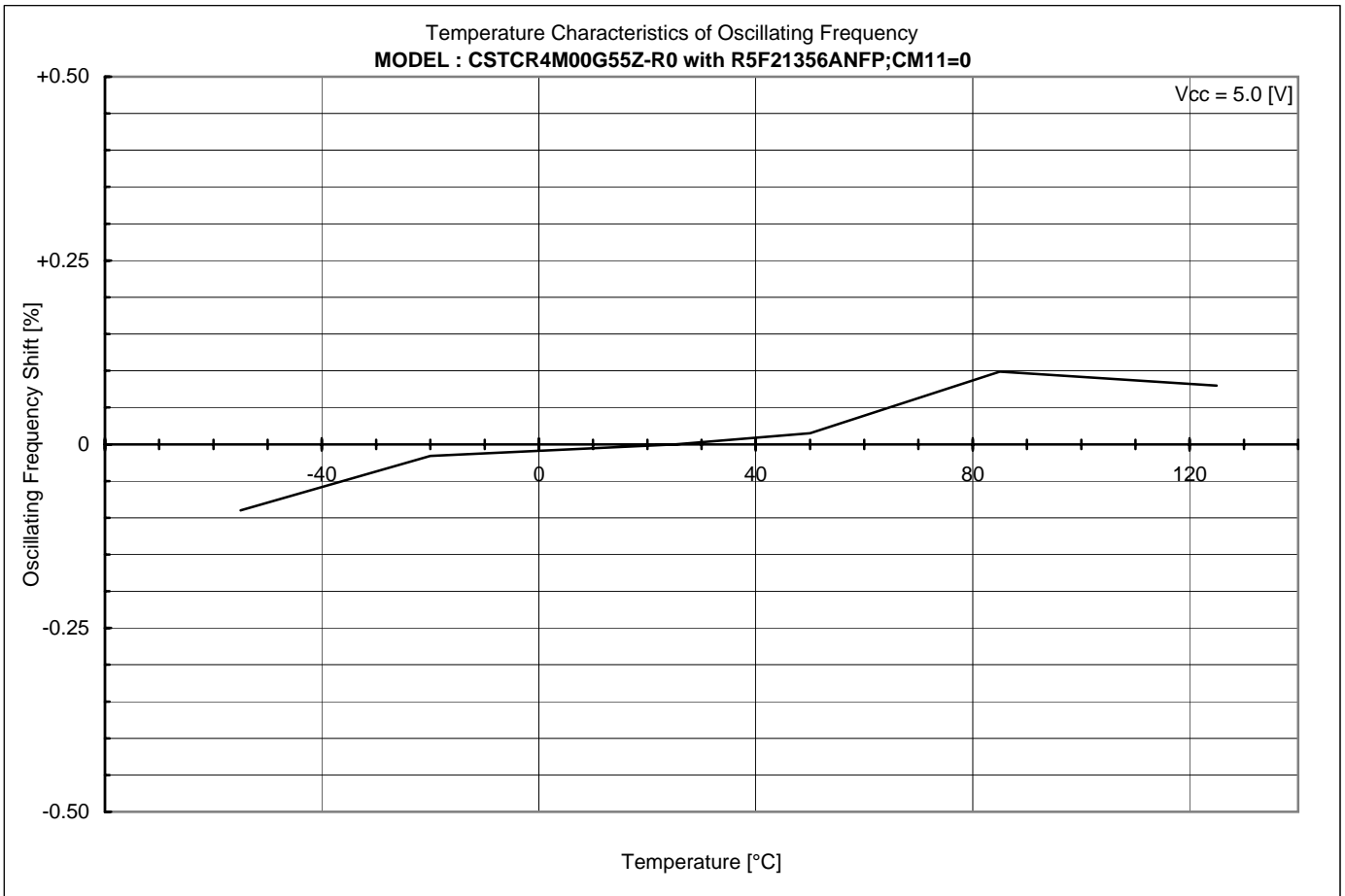

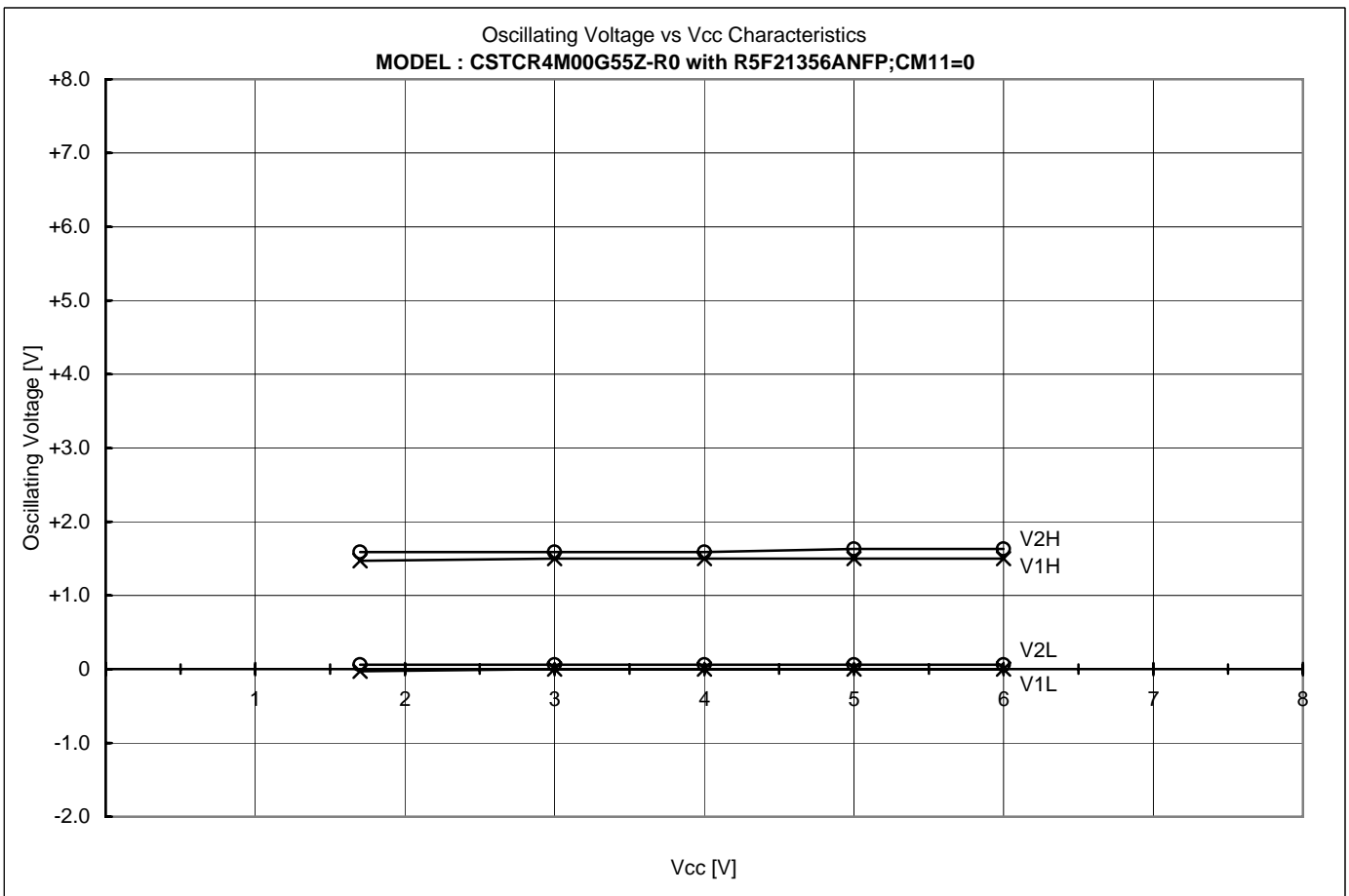
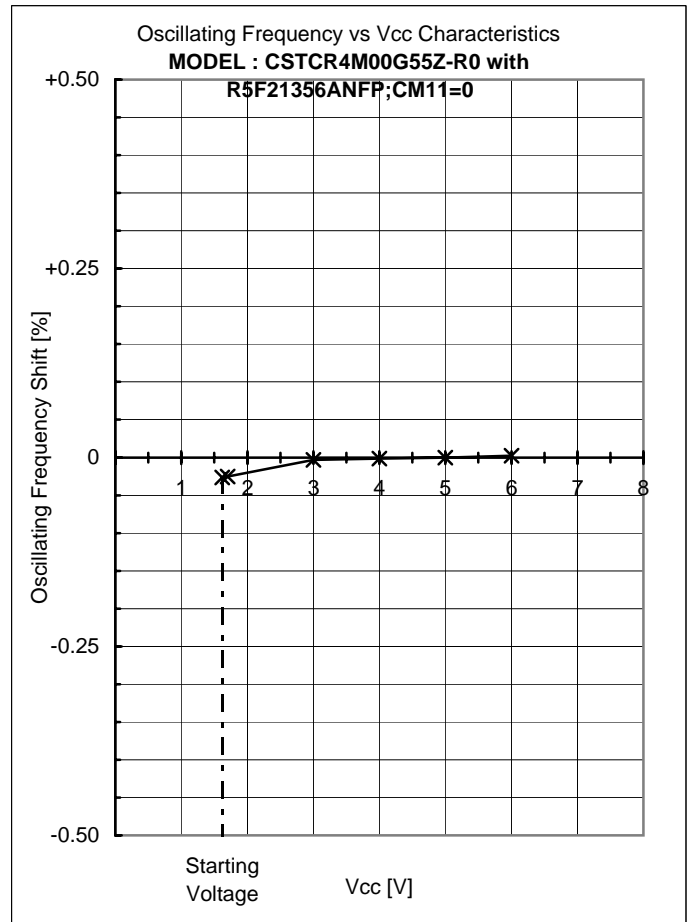
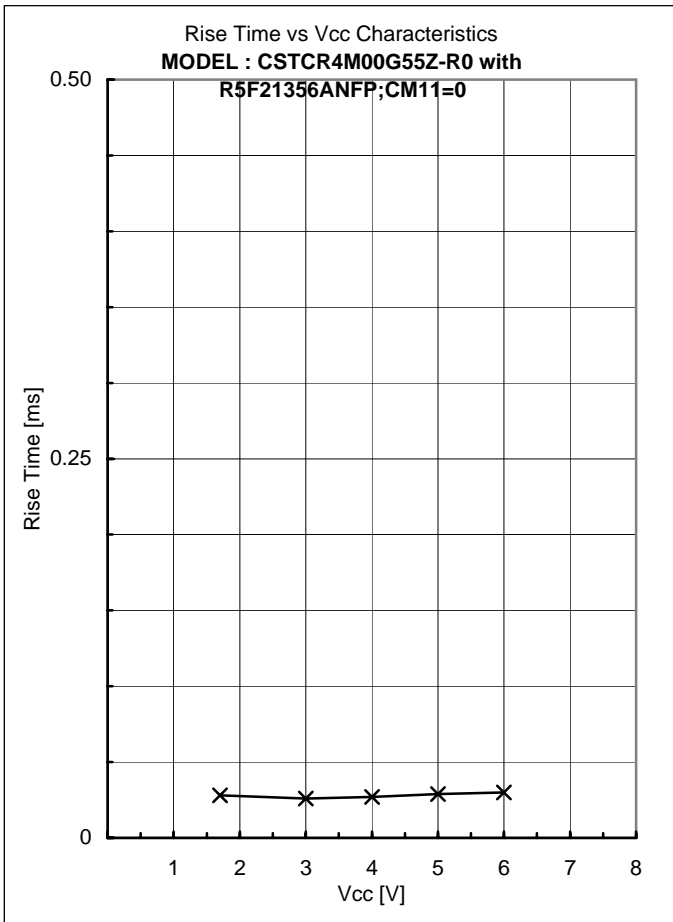

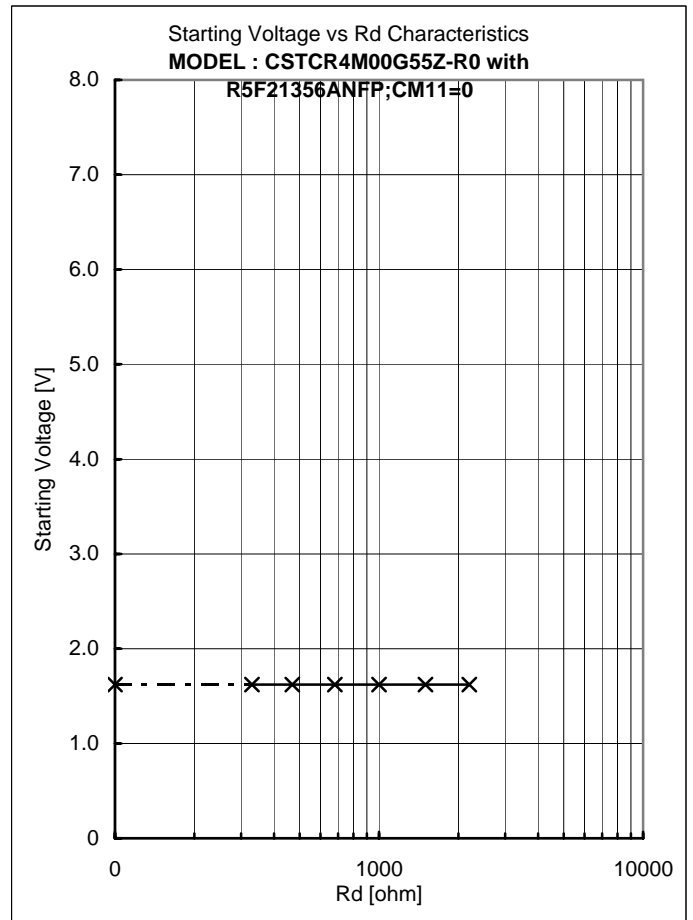
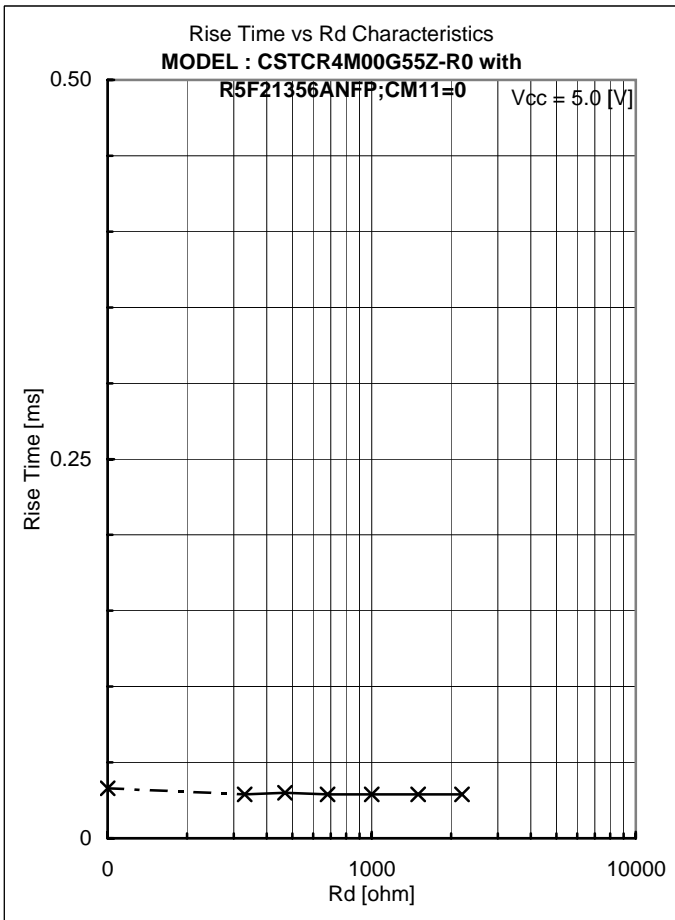
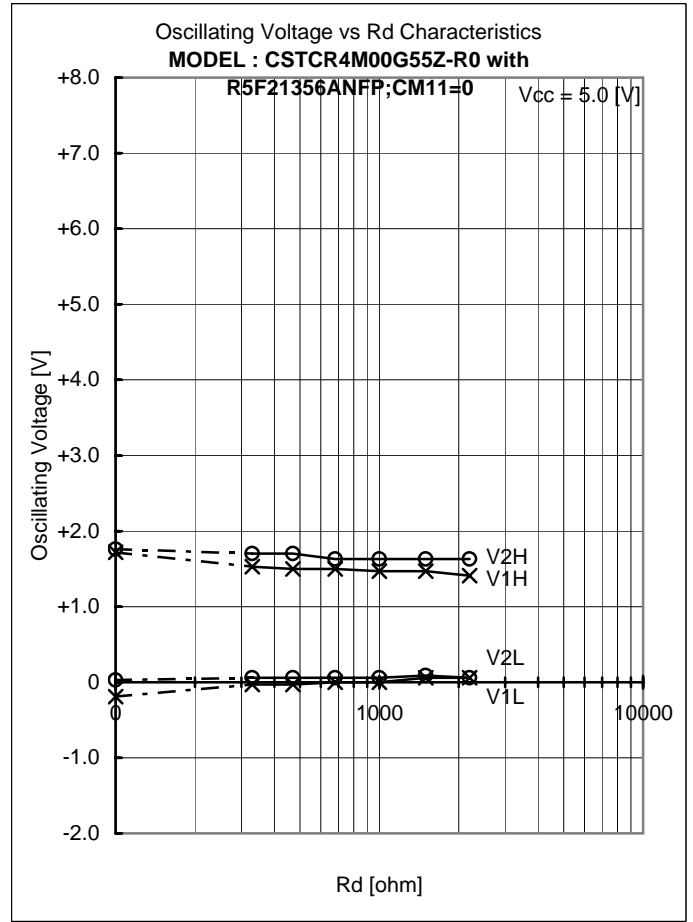
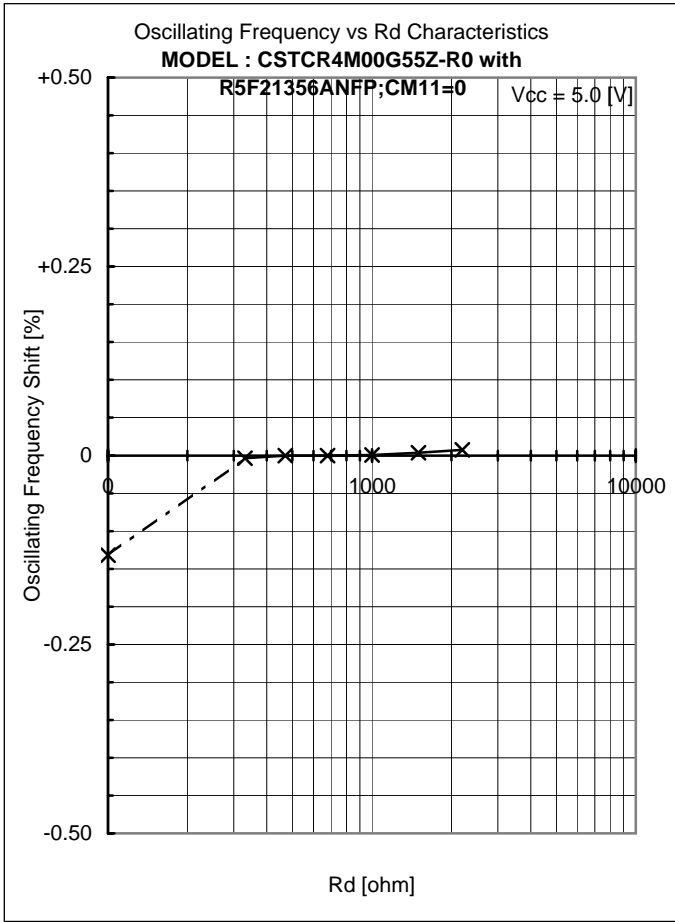

Appendixes

5. Comparison Table

5

Comparison Table

IC : No	V1H [V]	V1L [V]	V1p-p [V]	V2H [V]	V2L [V]	V2p-p [V]	Fosc [kHz]	Trise [ms]	Vstart [V]
LL	1.41	-0.03	1.44	1.63	0.06	1.57	3998.298	0.024	1.55
LH	1.50	0.00	1.50	1.63	0.06	1.57	3997.372	0.030	1.56
WS	1.50	0.00	1.50	1.63	0.06	1.57	3997.852	0.029	1.62
HL	1.34	-0.06	1.40	1.63	0.06	1.57	3997.258	0.029	1.40
HH	1.50	0.00	1.50	1.76	0.06	1.70	3997.031	0.039	1.61

Ref.

Performance described page 2 to 4 were measured with IC No. WS

Frequency Correlation Data

Sample No.	R5F21356ANFP;CM11=0 Fosc [kHz]	TC74HCU04 x2 Fosc [kHz]	Shift [%]
1	3999.494	3996.650	0.0712
2	3999.618	3997.370	0.0562
3	3998.360	3996.910	0.0363
4	4002.387	4001.090	0.0324
5	4002.195	3999.550	0.0661
X	4000.411	3998.314	0.0524

muRata Standard Circuit

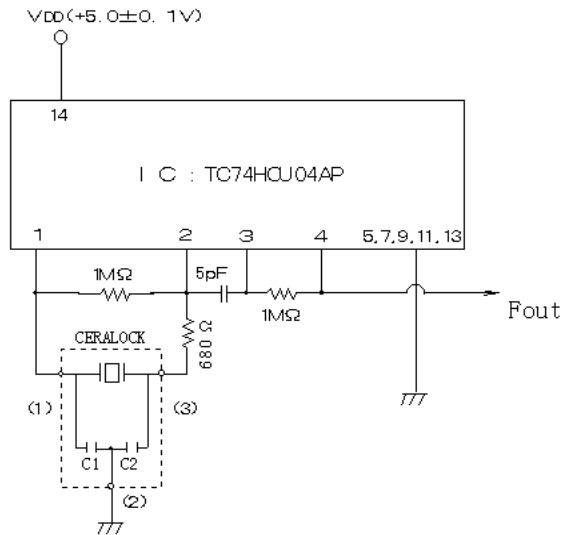

CERALOCK® : CSTCR4M00G55-R0

Vdd = +5.0 [V]

C1 = 39pF

C2 = 39pF

Rf = 1M [ohm]

Rd = 680 [ohm]

*(1)(2)(3)はピン番号を表します。詳しくは弊社仕様書またはカタログをご参照ください。

*(1),(2) and (3) means terminal number of resonator. Please see its specification or datasheet in detail.