

Evaluation of Subsystem Clock Oscillation Circuit

SSP-T7 12.5pF R5F2138CMNFP-80P [LQFP(12x12) 0.5mm pitch]

Measurement conditions : Vcc=3.0V



Model	:SSP-T7-F
Frequency	:Fo=32.768kHz
Frequency tolerance	:dF/Fo= +/-20x10 ⁻⁶
Load capacitance	:CL=12.5pF
Equivalent series resistance	:R1=65kohm max
Max. drive level	:DL=1x10 ⁻⁶ W max
Level of drive	:DL=0.1x10 ⁻⁶ W typ

FEATURES

- 1.Ultra thin type with 1.4mm Max.
- 2.SMD type suitable for automatic & high density surface mounting.
- 3.Plastic mold package containing highly reliable tubular type quartz crystal.
- 4.Excellent shock and heat resistance.
- 5.Cellular phones,PDA,Radio communication equipment, Portable applications etc.

RECOMMENDED SOLDERING PATTERN

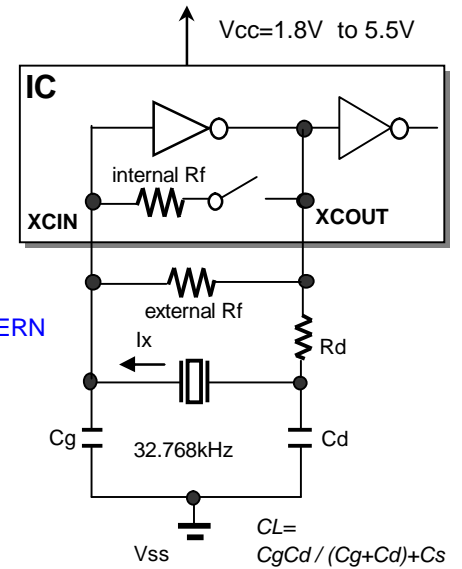
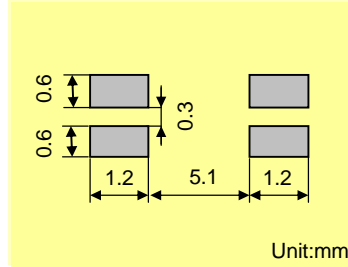

Remark) Ix : current through crystal

(*1)Only internal feedback resistance

(*2)Only external feedback resistance(10M)

MODEL:SSP-T7-F 12.5pF with R5F2138CMNFP at 25°C

Key specifications	Vcc=3.0V		Remarks
	Rf=built-in(*1)	Rf=10M (*2)	
Feedback resistance:Rf (Mohm)	Built-in	10	
Current control resistance : Rd (k ohm)	470	470	Control drive level & secure phase margin
Capacitance at gate : Cg (pF)	22	22	Optimal capacitance in response to CL
Capacitance at drain : Cd (pF)	22	22	(CL = Cd // Cg + stray capacitance)

Circuit characteristics (at 25°C)	Rf=built-in(*1)	Rf=10MΩ(*2)	Remarks
Matching Accuracy : df / f (x10 ⁻⁶)	-0.4	-1.6	Frequency offset volume at specified Vcc
Voltage Fluctuation : +/-df / V (x10 ⁻⁶)	0.0	0.0	Vcc +/-10% (Standard operating voltage range)
Drive Level : DL (x10 ⁻⁶ W)	0.05	0.05	DL=Ix ² Re < 1x10 ⁻⁶ W, Re=R1(1 + Co / CL) ²
Negative resistance : - RL (kohm)	1040	1040	5 times larger than R _{1MAX}
Oscillation allowance : M (times)	16	16	Judgemental standard of oscillation stability
Low consumption current : Id (uA)	0.556	0.508	Cd charge current, Id = f*Cd*Vd
Voltage of oscillation start : Vstrat (V)	1.63	1.63	
Voltage of oscillation stop : Vstop (V)	1.62	1.62	
Oscillation start up time : Ts (sec.)	0.33	0.30	Time to reach 90% of output level

Temperature characteristics of circuit		Rf=built-in(*1)	Rf=10MΩ(*2)	Remarks
at -40°C	Variation : df / T (x10 ⁻⁶)	-128	-128	Typ.Tp=25°C (K = -3.5x10 ⁻⁸ / °C ²)
at +85°C	Variation : df / T (x10 ⁻⁶)	-131	-131	Typ.Tp=25°C (K = -3.5x10 ⁻⁸ / °C ²)

The above mentioned value is only for your reference. The value is for the arbitrary samples and does not guarantee the product's characteristics. Please review and check above parameters at customer's end.

Seiko Instruments USA Inc.

2990,West Lomita Blvd., Torrance, CA 90505, U.S.A
 Telephone :+1 310-517-7771 Facsimile :+1 310-517-7792
 Email :info@siu-la.com

Seiko Instruments GmbH

Siemensstrasse 9,D-63263 Neu-Isenburg,Germany
 Telephone :+49-6102-297-0 Facsimile :+49-6102-297-320
 Email :info@seiko-instruments.de

Seiko Instruments Inc.

1-8,Nakase,Mihama-ku,Chiba-shi,Chiba 261-8507,Japan
 Facsimile :+81-43-211-8030
 E-mail :component@sii.co.jp



We value the "takumi" spirit.

Seiko Instruments Inc.

Phone:+81-43-211-1207(Direct)

Evaluation of Subsystem Clock Oscillation Circuit

SSP-T7 12.5pF R5F2138CMNFP [LQFP(12x12) 0.5mm pitch]

Measurement conditions : Vcc=3.0V



Test Data at 25°C

Signal wave from the oscillator
Rf=Built-in

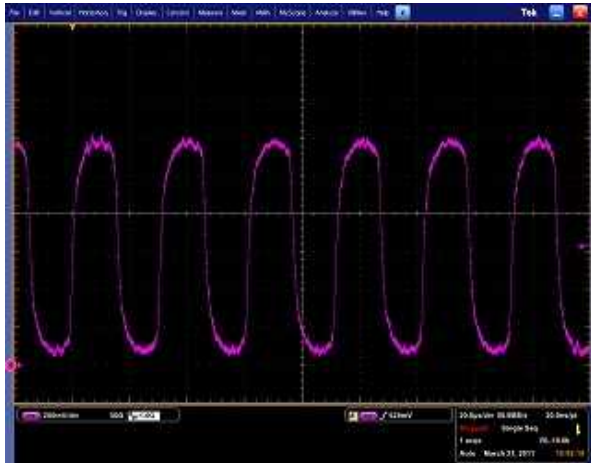

Signal wave from the oscillator
Rf=10M

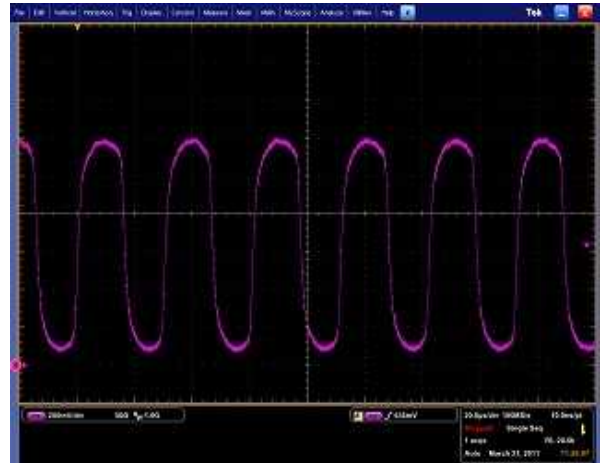

Start up time of SUB_Vout
Rf=Built-in

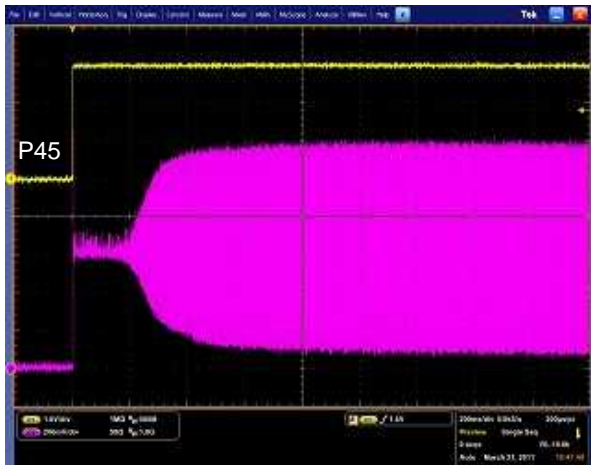

Start up time of SUB_Vout
Rf=10MΩ

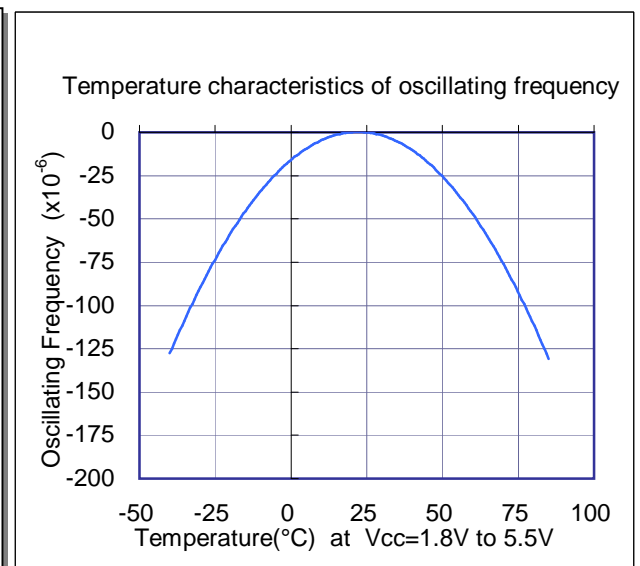
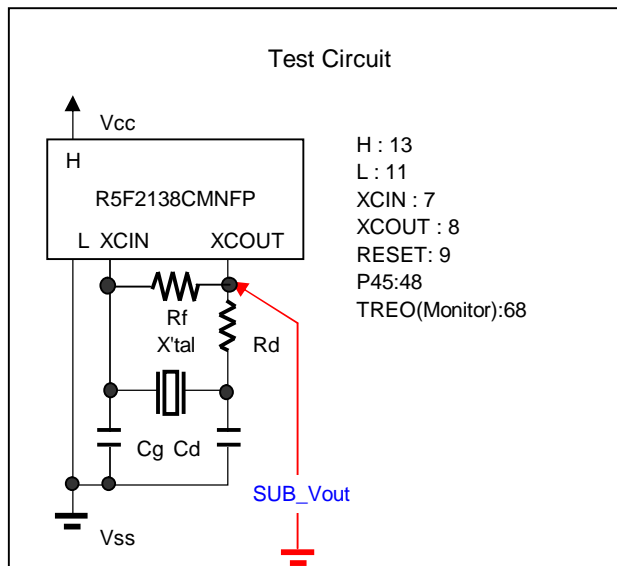
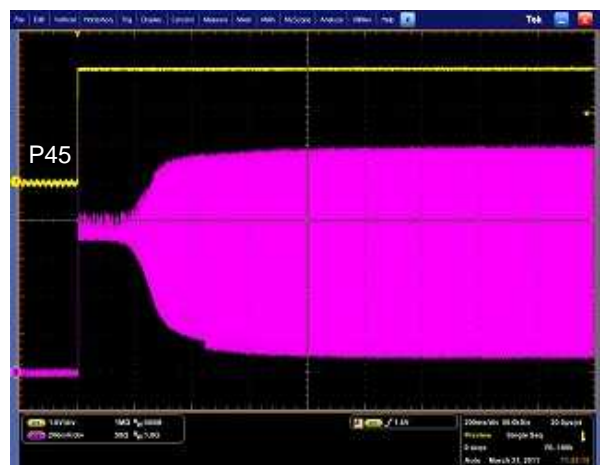

Evaluation of Subsystem Clock Oscillation Circuit

SSP-T7 12.5pF R5F2138CMNFP-80P [LQFP(12x12) 0.5mm pitch]

Measurement conditions : Vcc=3.0V



Test Data : Temperature characteristics

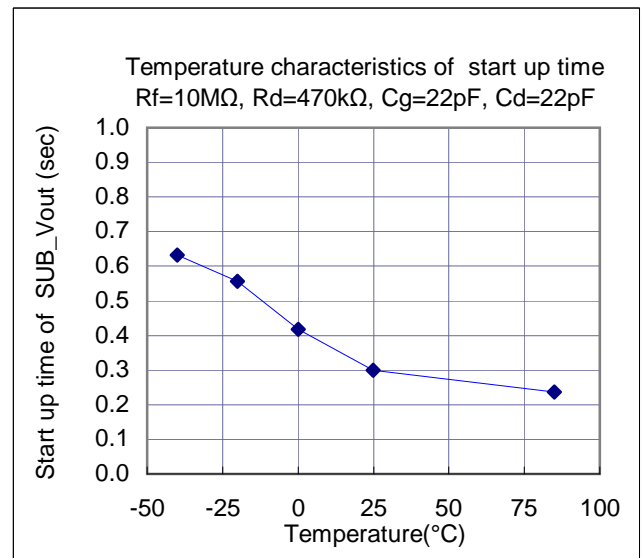
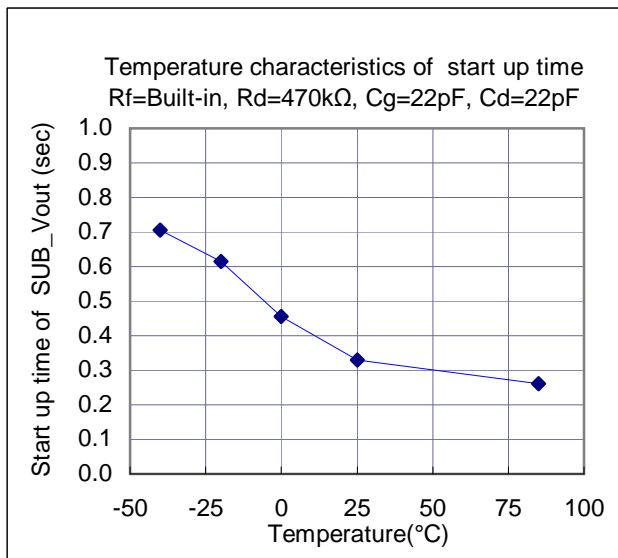
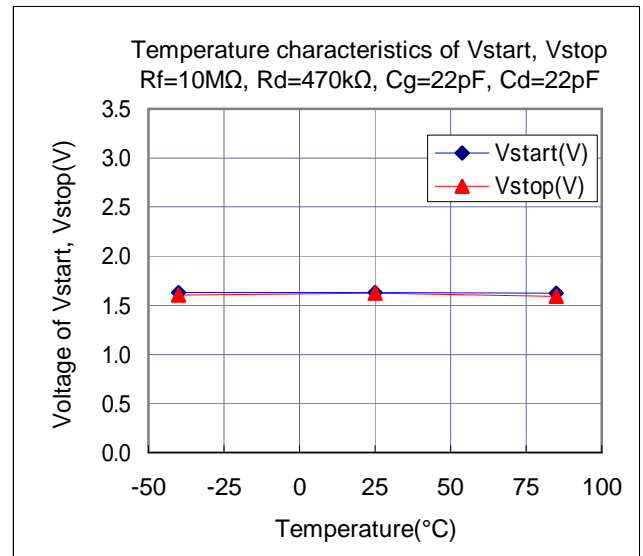
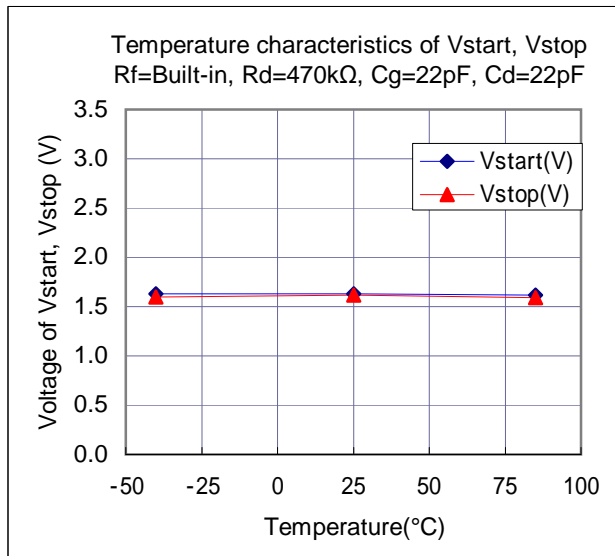
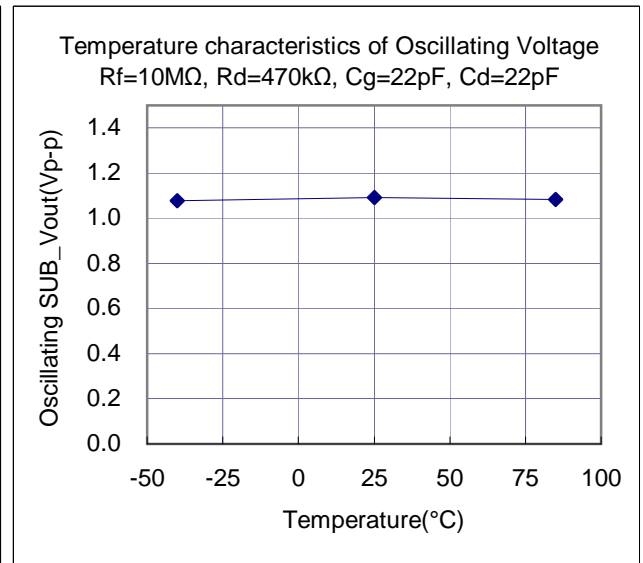
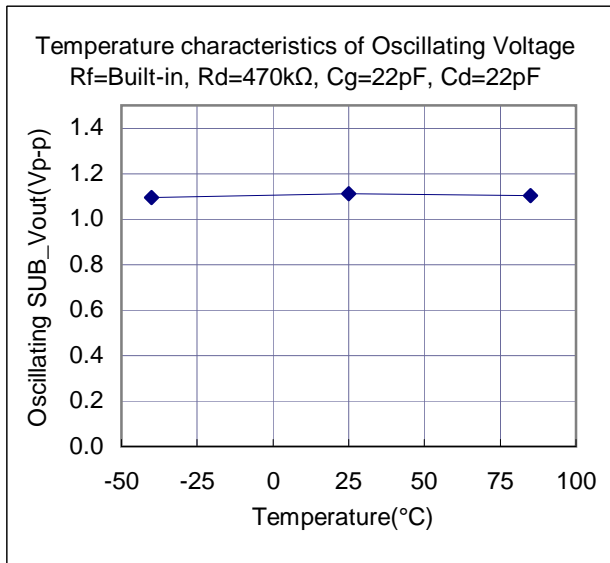

Evaluation of Subsystem Clock Oscillation Circuit

SSP-T7 12.5pF R5F2138CMNFP-80P [LQFP(12x12) 0.5mm pitch]

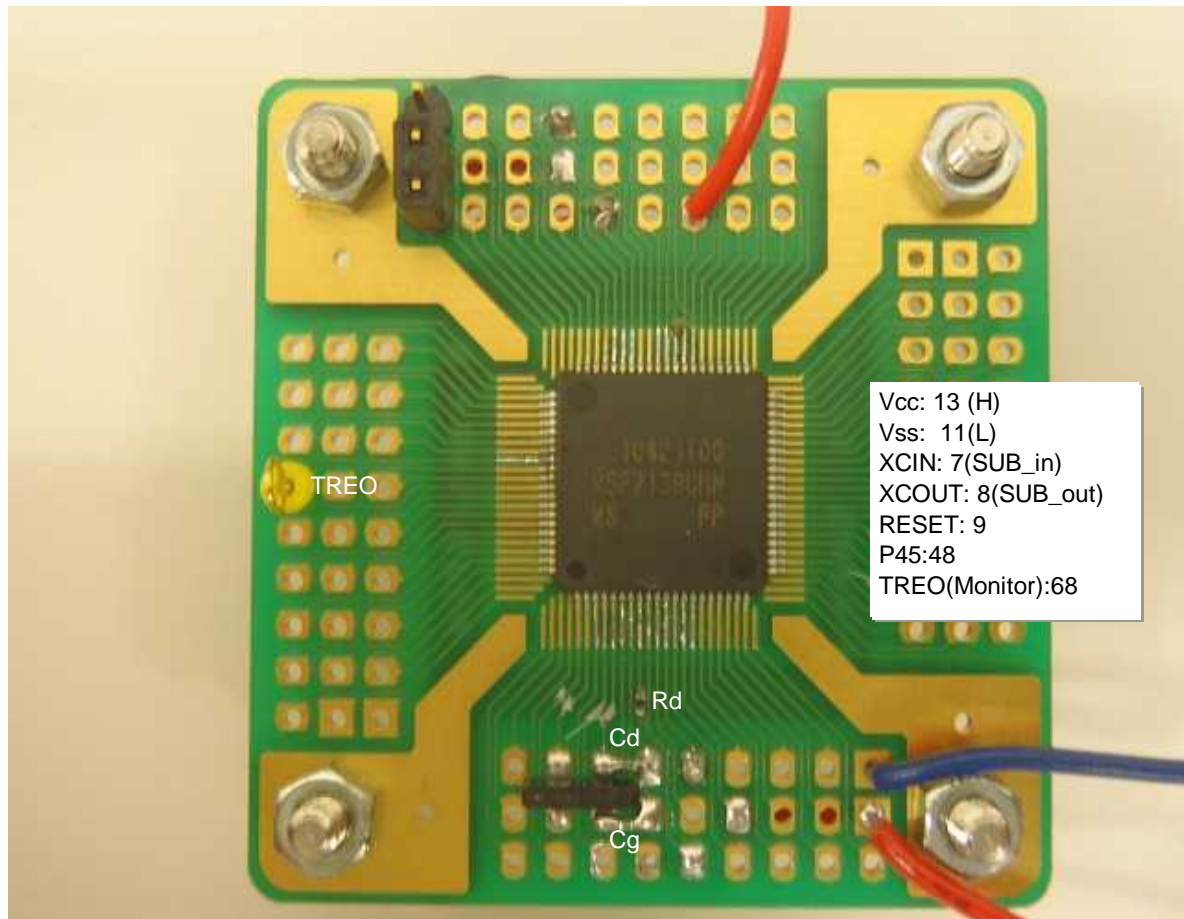
Measurement conditions : $V_{cc}=3.0V$ **Referential components layout(see Figure 1)****Figure 1 Referential components layout****Notes for Board Design**

When using a crystal resonator, place the resonator and its load capacitors as close as possible to SUB_in and SUB_out pins.

Other signal lines should be routed away from the resonator circuit to prevent induction from interfering with correct oscillation (see figure 2).

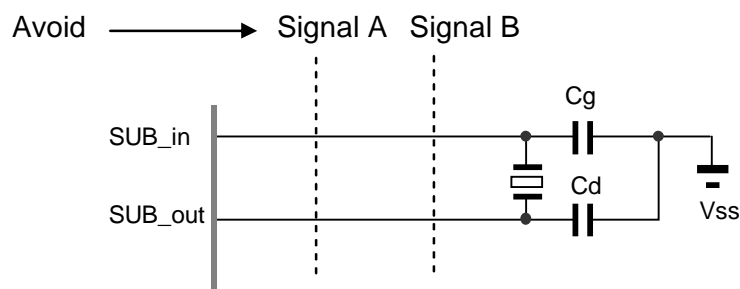
**Figure 2 Example of Incorrect Board Design**

Remark When using the subsystem clock, insert resistors R_d in series on the SUB_out side.

Evaluation of Subsystem Clock Oscillation Circuit

SSP-T7 12.5pF R5F2138CMNFP-80P [LQFP(12x12) 0.5mm pitch]

Measurement conditions : Vcc=3.0V

**[Evaluation Sample at 25°C]**

SAMPLE	No.	CL(pF)	Fo(Hz)	fr(Hz)	R1(kohm)	Co(pF)	C1(fF)	Q(k)
SSP-T7-F	1	12.5	32768.14	32765.32	34.5	0.93	2.312	60.9
	2	12.5	32768.20	32765.61	35.1	0.90	2.119	65.4
	3	12.5	32767.99	32765.36	35.5	0.93	2.157	63.5

[IC Test Data : IC sample Rf=Built in, Rd=470k ohm, Cg=22pF, Cd=22pF at 25°C]

Vcc=3.0V	IC sample	Fosc(Hz)	df / f(x10 ⁻⁶)	DL(x10 ⁻⁶ W)	-RL (kohm)	Vstart(V)	Ts(sec)
Rf=Built in	Typ.	32768.187	-0.40	0.05	1040	1.63	0.33
	HH	32768.156	-1.34	0.06	600	1.59	0.52
	LL	32768.212	0.37	0.05	1240	1.58	0.29

[IC Test Data : IC sample Rf=10M ohm, Rd=470kohm, Cg=22pF, Cd=22pF at 25°C]

Vcc=3.0V	IC sample	Fosc(Hz)	df / f(x10 ⁻⁶)	DL(x10 ⁻⁶ W)	-RL (kohm)	Vstart(V)	Ts(sec)
Rf=10M	Typ.	32768.149	-1.56	0.05	1040	1.63	0.30
	HH	32768.132	-2.08	0.05	660	1.59	0.51
	LL	32768.172	-0.85	0.05	1540	1.58	0.22

Remark (see figure 3)

$$F_o = f_r \times \left\{ \frac{C_1}{2 \times (C_o + C_L)} + 1 \right\} \text{ (Hz)}$$

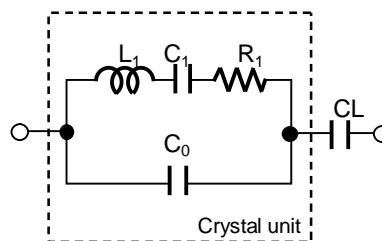

Fo : Load resonance frequency
 fr : Resonance frequency
 R1 : Motional resistance
 C1 : Motional capacitance
 Co : Shunt capacitance
 CL : Load Capacitance

Figure 3 Equivalent circuit of crystal unit, and CL**Remark (see figure 4)**

Approximate formula of the load capacitance of the circuit CL.

$$CL = C_g \times C_d / (C_g + C_d) + C_s \text{ (pF)}$$

Where Cs(=1.5 to 2pF) Stands for stray capacitance of the circuit.

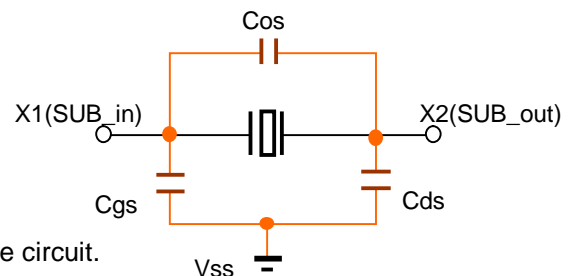

Cos : X1_X2 Stray capacitance
 Cgs : X1_Vss Stray capacitance
 Cds : X2_Vss Stray capacitance

Figure 4 Stray capacitance Cos,Cgs,Cds of the circuit

Resonator circuit constants will differ depending on the resonator element, stray capacitance in its interconnecting circuit, and other factors. Suitable constants should be determined in consultation with the resonator element manufacturer.

Evaluation of Subsystem Clock Oscillation Circuit

SSP-T7 12.5pF R5F2138CMNFP-80P [LQFP(12x12) 0.5mm pitch]

Measurement conditions : Vcc=1.8V to 5.5V at 25°C



Referential Data(1) : Voltage characteristics

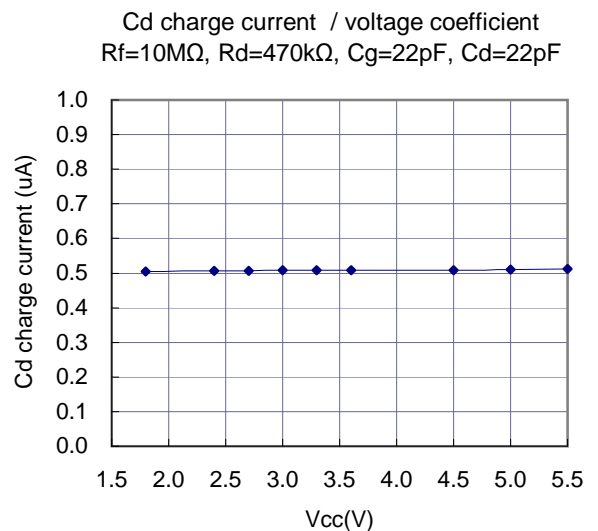
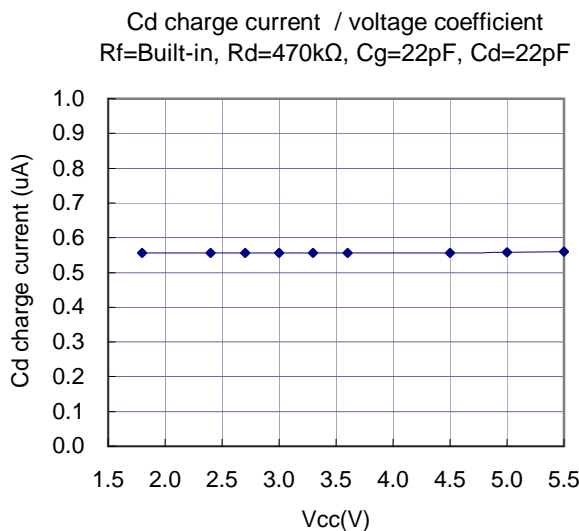
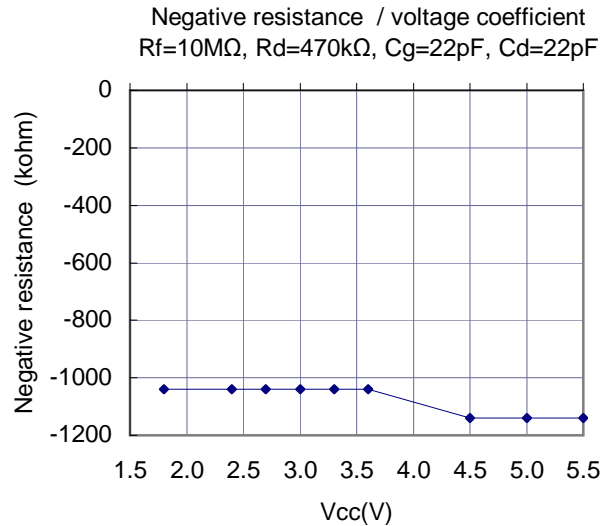
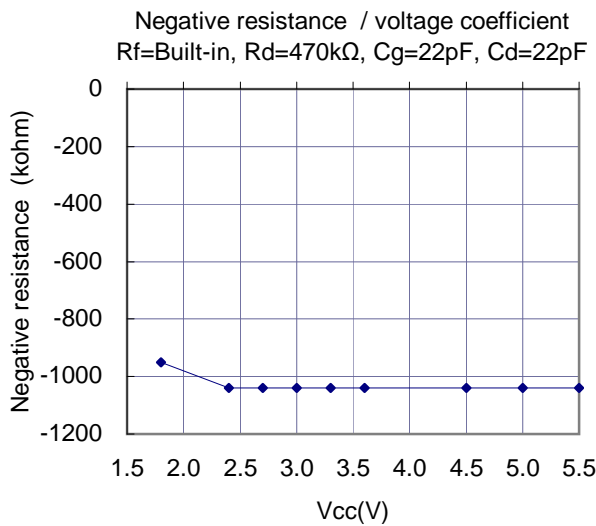
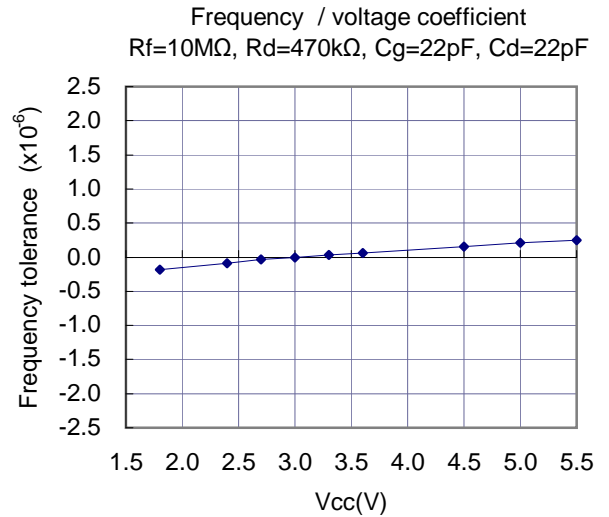
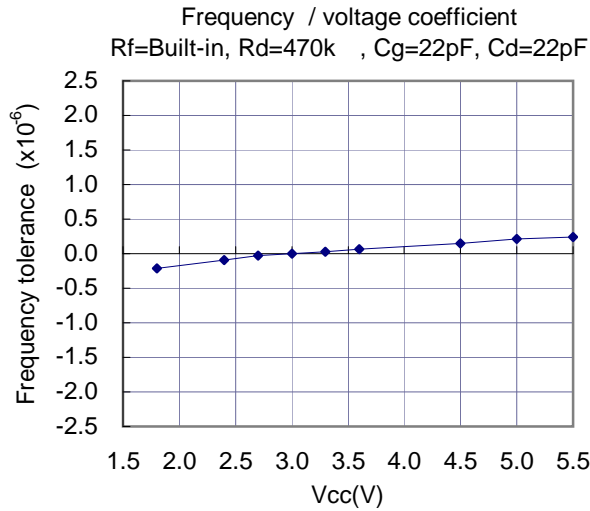

Evaluation of Subsystem Clock Oscillation Circuit

SSP-T7 12.5pF R5F2138CMNFP-80P [LQFP(12x12) 0.5mm pitch]

Measurement conditions : Vcc=1.8V to 5.5V at 25°C



Referential Data(2) : Voltage characteristics

