



Total dose testing of the ISL73096EH radiation hardened ultra high frequency NPN/PNP transistor array

Nick van Vonno
Intersil Corporation

Revision 0
29 May 2014

Table of Contents

- 1. Introduction**
- 2. Reference documents**
- 3. Part description**
- 4. Test description**
 - 4.1. Irradiation facility**
 - 4.2. Test fixturing**
 - 4.3. Characterization equipment and procedures**
 - 4.4. Experimental matrix**
 - 4.5. Downpoints**
- 5. Results**
 - 5.1. Attributes data**
 - 5.2. Variables data**
- 6. Conclusion**
- 7. Appendices**
- 8. Document revision history**

1. Introduction

This document reports the results of low and high dose rate total dose testing of the Intersil ISL73096EH NPN/PNP transistor array. The test was performed in 2014 with the objective of providing an assessment of the low dose rate hardness and dose rate sensitivity of the part. Parts were irradiated under bias and with all pins grounded at low dose rate and under bias at high dose rate. The ISL73096EH is a five-transistor array comprising three NPN transistors and two PNP transistors and is built in the Intersil UHF process, which uses bonded wafer dielectric isolation technology. The DI process results in excellent isolation between transistors while retaining the thermal and electrical matching advantages of single-die construction. The ISL73127RH and ISL73128RH are NPN only and PNP only versions of the ISL73096EH; as the oxide thickness and doping levels are similar for all three parts are closely similar, the present data is considered to apply to all three parts.

2. Reference Documents

MIL-STD-883 test method 1019.
ISL73096EH data sheet.
SMD 5962-07218.

3: Part Description

The ISL73096RH consists of three NPN transistors and two PNP transistors on a common substrate. The part is built in a dielectrically isolated bonded wafer fabrication process providing single event latch-up (SEL) immunity, while the high frequency vertical transistor structures provide excellent AC performance and total dose hardness.

The high gain-bandwidth product and low noise figure of these transistors make them ideal for use in high frequency RF amplifier and mixer applications. Monolithic construction of the NPN and PNP transistors provides the closest electrical and thermal matching possible. Access is provided to each terminal of each of the transistors for maximum application flexibility.

Specifications for Rad Hard QML devices are controlled by the Defense Logistics Agency (DLA) in Columbus, OH. The listed SMD numbers must be used when ordering. Detailed electrical specifications for these devices are contained in SMD 5962-07218. A “hot-link” is provided on our website for downloading.

- QML qualified per MIL-PRF-38535 requirements
- Electrically screened to SMD # 5962-07218
 - Total dose, high dose rate 3 x 10⁵rad(Si)
 - SEL immune by process
- NPN gain bandwidth product (FT) 8GHz (typical)
- NPN current gain (hFE) 130 (typical)
- NPN Early voltage (VA) 50V (typical)
- PNP gain bandwidth product (FT) 5.5GHz (typical)
- PNP current gain (hFE) 60 (typical)
- PNP Early voltage (VA) 20V (typical)
- Noise figure (50Ω) at 1GHz 3.5dB (typical)
- Collector-to-collector leakage <1pA (typical)

4: Test Description

4.1 Irradiation Facilities

Low dose rate testing was performed at 0.01rad(Si)/s using the Intersil Palm Bay N40 (Hopewell Designs, Alpharetta, GA) panoramic ^{60}Co irradiator located in the Palm Bay, Florida facility. High dose rate testing was performed at 65rad(Si)/s in a Gammacell 220 ^{60}Co irradiator located in the same facility.

4.2 Test Fixturing

Samples were irradiated under biased and grounded conditions (low dose rate samples) and under biased conditions (high dose rate samples). Fig. 1 shows the configuration used for biased irradiation; the grounded configuration simply grounds all pins and is not shown.

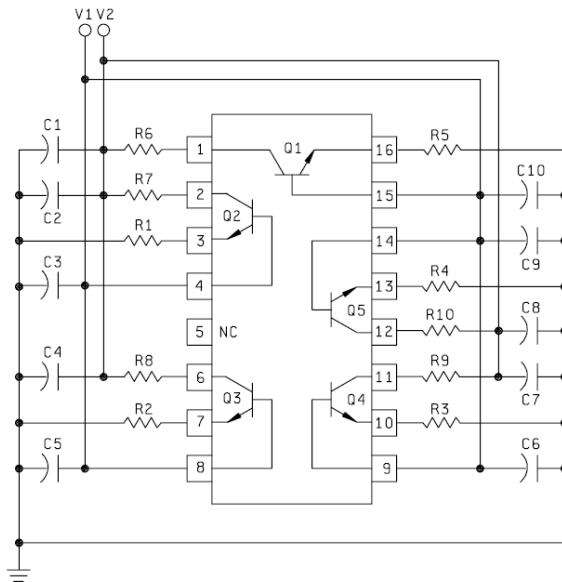

Figure 1: Irradiation bias configuration for the ISL73096EH. $V1 = 5.5\text{V} \pm 0.5\text{V}$; $V2 = 10.5\text{V} \pm 0.5\text{V}$; $R1$, $R2$, $R3$, $R4$ and $R5 = 1.0\text{k}\Omega \pm 5\%$; $R6$, $R7$, $R8$, $R9$ and $R10 = 100.0\Omega \pm 5\%$; and $C1$ through $C10 = 0.01\mu\text{F}$, 25V. These devices feature an F_T of 8GHz/5.5GHz and are heavily AC bypassed to insure stability.

4.3 Characterization equipment and procedures

All electrical testing was performed outside the irradiator using production automated test equipment (ATE) with datalogging at each downpoint. Downpoint electrical testing was performed at room temperature only.

4.4 Experimental matrix

Total dose irradiation proceeded in accordance with the guidelines of MIL-STD-883 Test Method 1019.7. The experimental matrix consisted of 24 samples irradiated at low dose rate under bias, 24 samples irradiated at low dose

rate with all pins grounded and 36 samples irradiated at high dose rate under bias. Several control units were used to insure repeatable data at all downpoints.

Samples of the ISL73096EH were drawn from production fabrication lot DTJ6DB as part of the Intersil wafer by wafer total dose acceptance testing program and were packaged in the hermetic 16-pin solder-sealed flatpack (CDFP4-16) package. Samples were processed through the standard burnin cycle before irradiation, as required by MIL-STD-883, and were screened to the ATE limits at room temperature prior to the test.

4.5 Downpoints

Downpoints for the biased and grounded low dose rate tests were zero, 10, 30 and 50krad(Si). The single downpoint for the biased high dose rate test was 300krad(Si).

5. Test results

Testing at low and high dose rate of the ISL73096EH is complete. All monitored parameters were very stable over both irradiation and anneals. Additionally, no transistor to transistor differences were noted, either in the pre-irradiation data or in the total dose response of the parts, and no bias or dose rate sensitivity was noted.

5.2 Attributes data

Table 1: ISL73096EH low dose rate total dose test attributes data.

Part	Dose rate (Note 1)	Bias	Sample size	Downpoint	Pass (Note 2)	Rejects
ISL73096EH	LDR	Biased	24	Pre-irradiation	24	
				10 krad(Si)	24	0
				30 krad(Si)	24	0
				50 krad(Si)	24	0
ISL73096EH	LDR	Grounded	24	Pre-irradiation	24	
				10 krad(Si)	24	0
				30 krad(Si)	24	0
				50 krad(Si)	24	0
ISL73096EH	HDR	Biased	36	Pre-irradiation	36	
				300 krad(Si)	36	0

Note 1: 'LDR' indicates low dose rate (0.01 rad(Si)/s); 'HDR' indicates high dose rate (50-300rad(Si)/s).

Note 2: 'Pass' indicates a sample that passes all post-irradiation SMD limits.

5.2 Variables data

Figs. 2 through 21 plot the response of key parameters. In the plots, the individual transistors are designated as NPN device 1 ('Q1') through device 3 ('Q3') and PNP device 4 ('Q4') and device 5 ('Q5').The NPN and PNP devices are plotted separately, with Figs. 2 through 11 reporting the NPN data and Figs. 12 through 21 reporting the PNP data. The plots show the average of key parameters as a function of low and high dose rate total dose for each of the two irradiation conditions. We chose to plot the average for these parameters; the parametric distributions were sufficiently tight that plotting them would have been difficult.

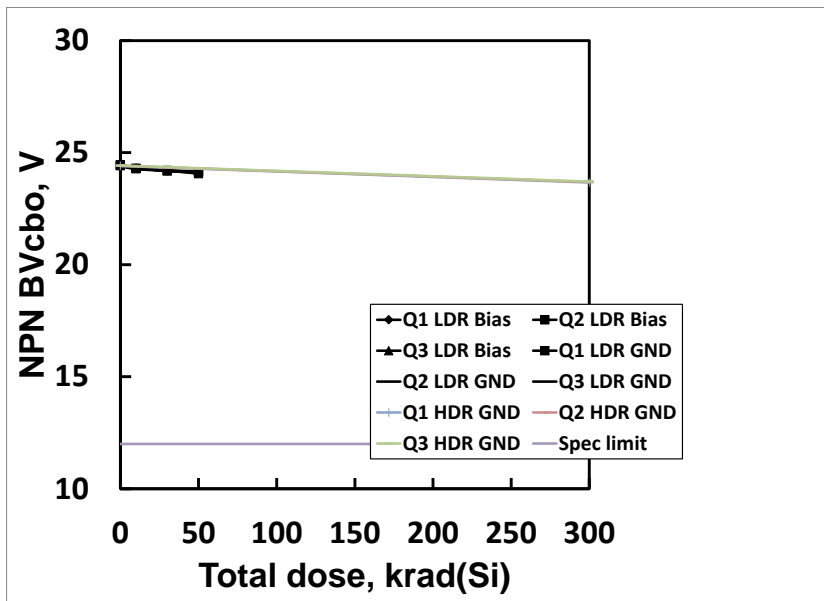

Fig. 2: ISL73096EH NPN collector-base breakdown voltage, emitter open (BVcbo), devices Q1 through Q3, plotted as a function of low dose rate irradiation for the biased (per Figure 1) and unbiased (all pins grounded) cases and for high dose rate irradiation for the biased (per Fig. 1) case. The low dose rate was 0.01 rad(Si)/s and the high dose rate was 65rad(Si)/s. Sample size for the low dose rate cells was 24 and sample for the high dose rate cell was 36. The pre-irradiation SMD limit is 12.0V minimum, while the post-irradiation SMD limit is also 12.0V minimum.

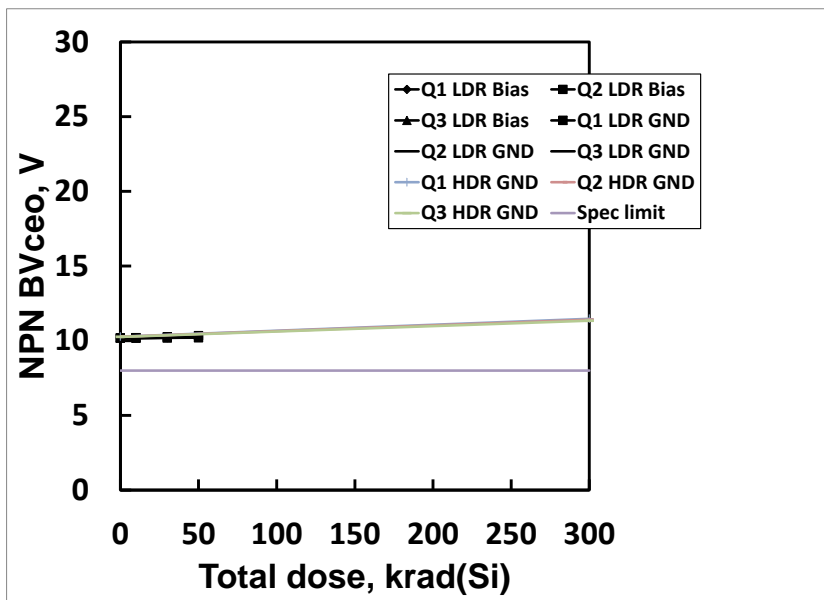

Fig. 3: ISL73096EH NPN collector-emitter breakdown voltage, base open (BVceo), devices Q1 through Q3, plotted as a function of low dose rate irradiation for the biased (per Figure 1) and unbiased (all pins grounded) cases and for high dose rate irradiation for the biased (per Fig. 1) case. The low dose rate was 0.01 rad(Si)/s and the high dose rate was 65rad(Si)/s. Sample size for the low dose rate cells was 24 and sample for the high dose rate cell was 36. The pre-irradiation SMD limit is 8.0V minimum, while the post-irradiation SMD limit is also 8.0V minimum.

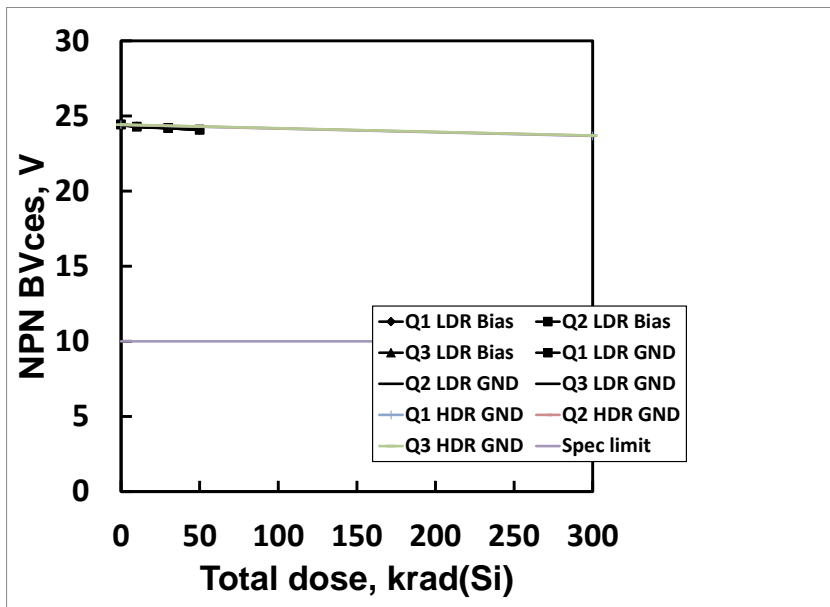

Fig. 4: ISL73096EH NPN collector-emitter breakdown voltage, base shorted to emitter open (BVces), devices Q1 through Q3, plotted as a function of low dose rate irradiation for the biased (per Figure 1) and unbiased (all pins grounded) cases and for high dose rate irradiation for the biased (per Fig. 1) case. The low dose rate was 0.01 rad(Si)/s and the high dose rate was 65rad(Si)/s. Sample size for the low dose rate cells was 24 and sample for the high dose rate cell was 36. The pre-irradiation SMD limit is 10.0V minimum, while the post-irradiation SMD limit is also 10.0V minimum.

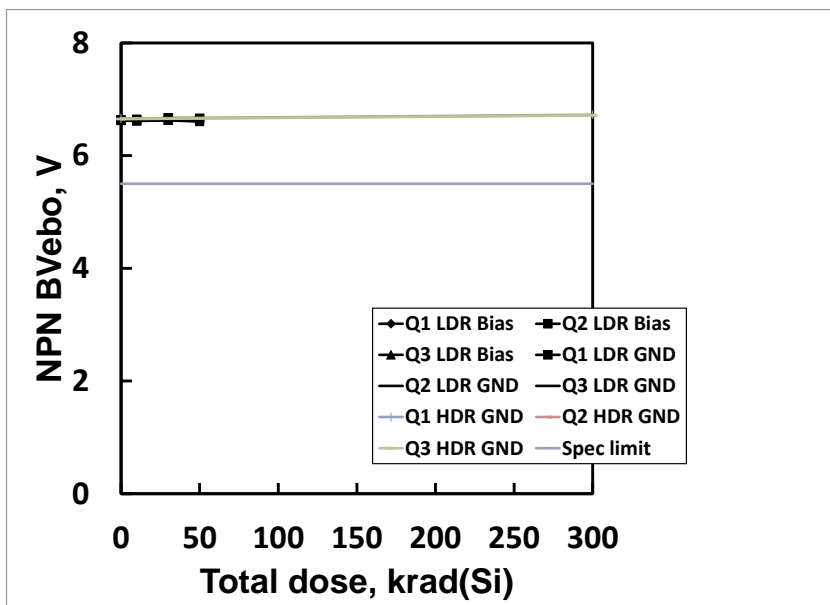

Fig. 5: ISL73096EH NPN emitter-base breakdown voltage, collector open (BVebo), devices Q1 through Q3, plotted as a function of low dose rate irradiation for the biased (per Figure 1) and unbiased (all pins grounded) cases and for high dose rate irradiation for the biased (per Fig. 1) case. The low dose rate was 0.01 rad(Si)/s and the high dose rate was 65rad(Si)/s. Sample size for the low dose rate cells was 24 and sample for the high dose rate cell was 36. The pre-irradiation SMD limit is 5.5V minimum, while the post-irradiation SMD limit is also 5.5V minimum.

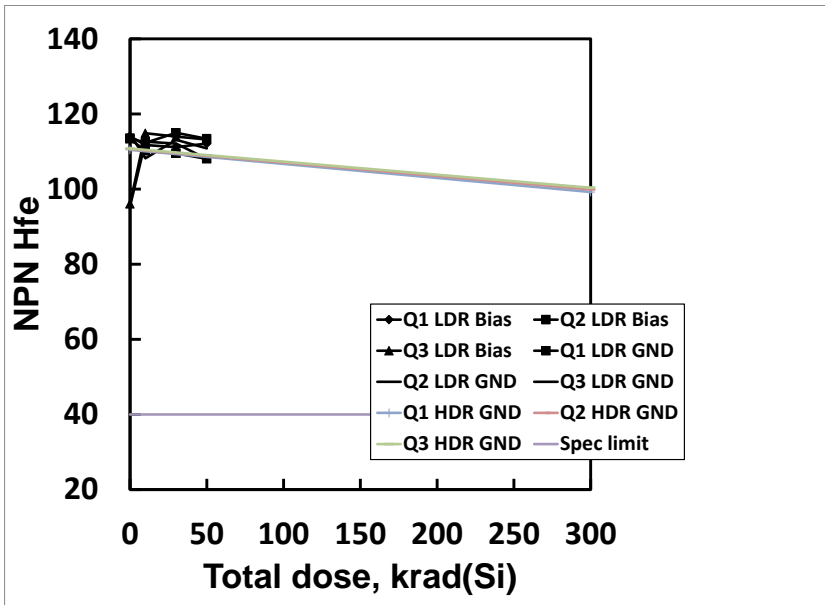

Fig. 6: ISL73096EH NPN common-emitter current gain (Hfe) at $I_c = 10.0\text{mA}$ and $V_{ce} = 2.0\text{V}$, devices Q1 through Q3, plotted as a function of low dose rate irradiation for the biased (per Figure 1) and unbiased (all pins grounded) cases and for high dose rate irradiation for the biased (per Fig. 1) case. The low dose rate was 0.01 rad(Si)/s and the high dose rate was 65 rad(Si)/s . Sample size for the low dose rate cells was 24 and sample for the high dose rate cell was 36. The pre-irradiation SMD limit is 80 minimum, while the post-irradiation SMD limit is 40 minimum. Current gain is a dimensionless parameter.

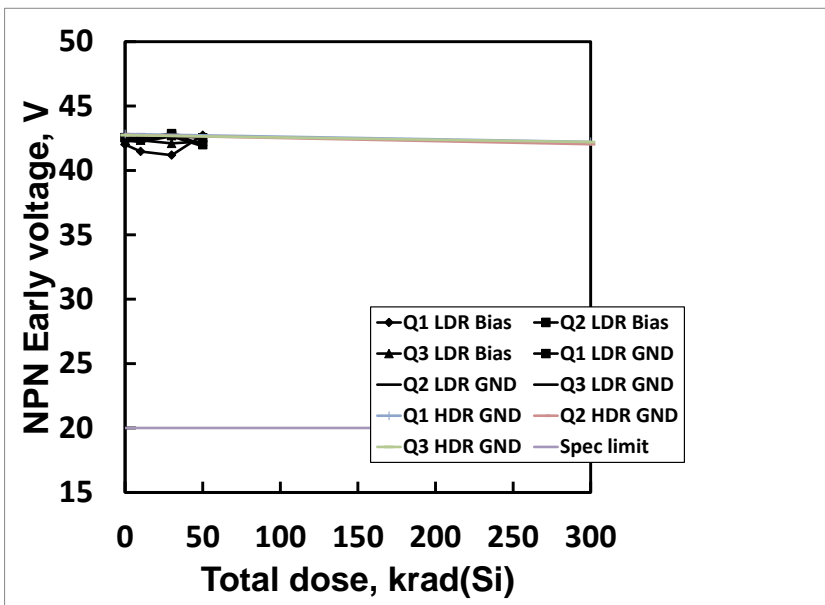

Fig.7: ISL73096EH NPN Early voltage (V_A), devices Q1 through Q3, plotted as a function of low dose rate irradiation for the biased (per Figure 1) and unbiased (all pins grounded) cases and for high dose rate irradiation for the biased (per Fig. 1) case. The low dose rate was 0.01 rad(Si)/s and the high dose rate was 65 rad(Si)/s . Sample size for the low dose rate cells was 24 and sample for the high dose rate cell was 36. The pre-irradiation SMD limit is 20.0V minimum, while the post-irradiation SMD limit is also 20.0V minimum.

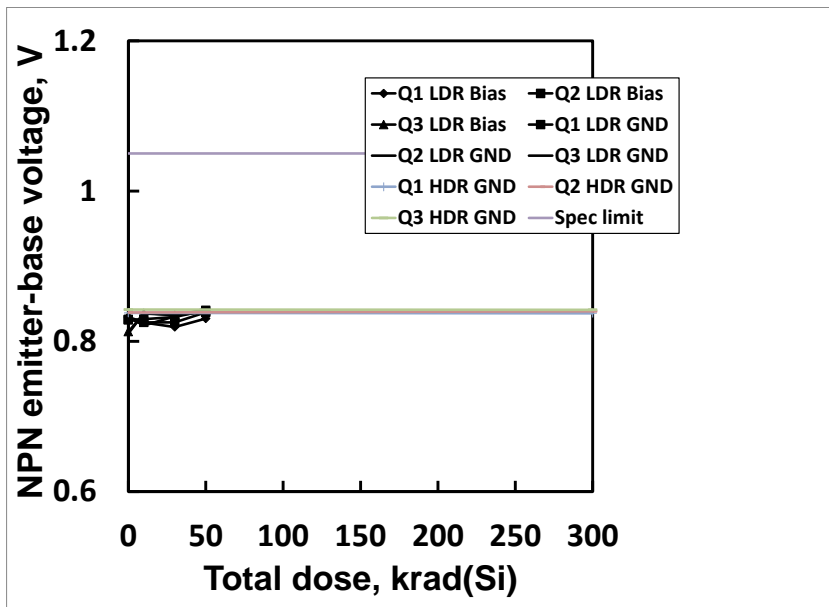

Fig. 8: ISL73096EH NPN emitter-base voltage (V_{be}) at 10.0mA, devices Q1 through Q3, plotted as a function of low dose rate irradiation for the biased (per Figure 1) and unbiased (all pins grounded) cases and for high dose rate irradiation for the biased (per Fig. 1) case. The low dose rate was 0.01 rad(Si)/s and the high dose rate was 65rad(Si)/s. Sample size for the low dose rate cells was 24 and sample for the high dose rate cell was 36. The pre-irradiation SMD limit is 0.95V maximum, while the post-irradiation SMD limit is 1.05V maximum.

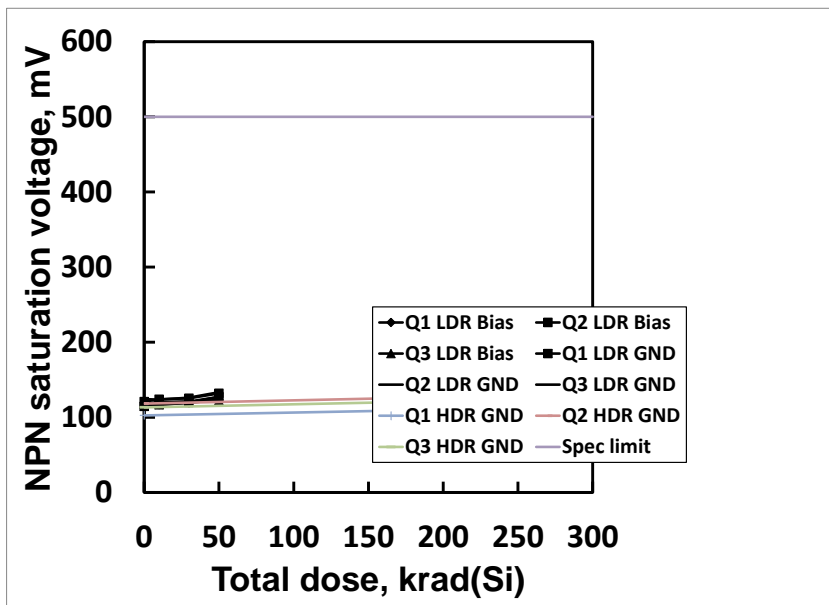

Fig. 9: ISL73096EH NPN collector-emitter saturation voltage ($V_{ce(sat)}$), devices Q1 through Q3, plotted as a function of low dose rate irradiation for the biased (per Figure 1) and unbiased (all pins grounded) cases and for high dose rate irradiation for the biased (per Fig. 1) case. The low dose rate was 0.01 rad(Si)/s and the high dose rate was 65rad(Si)/s. Sample size for the low dose rate cells was 24 and sample for the high dose rate cell was 36. The pre-irradiation SMD limit is 500.0mV maximum, while the post-irradiation SMD limit is also 500.0mV maximum.

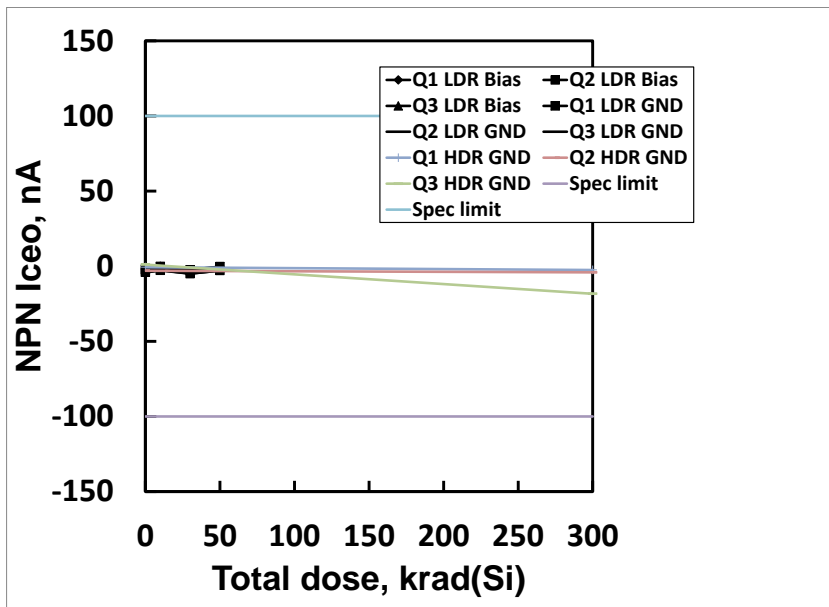

Fig. 10: ISL73096EH NPN collector-emitter leakage current (I_{ceo}), devices Q1 through Q3, plotted as a function of low dose rate irradiation for the biased (per Figure 1) and unbiased (all pins grounded) cases and for high dose rate irradiation for the biased (per Fig. 1) case. The low dose rate was 0.01 rad(Si)/s and the high dose rate was 65rad(Si)/s. Sample size for the low dose rate cells was 24 and sample for the high dose rate cell was 36. The internal Intersil limits are -100.0nA to +100.0nA maximum, while the post-irradiation limits are also -100.0nA to +100.0nA maximum. The parameter is not specified in the SMD.

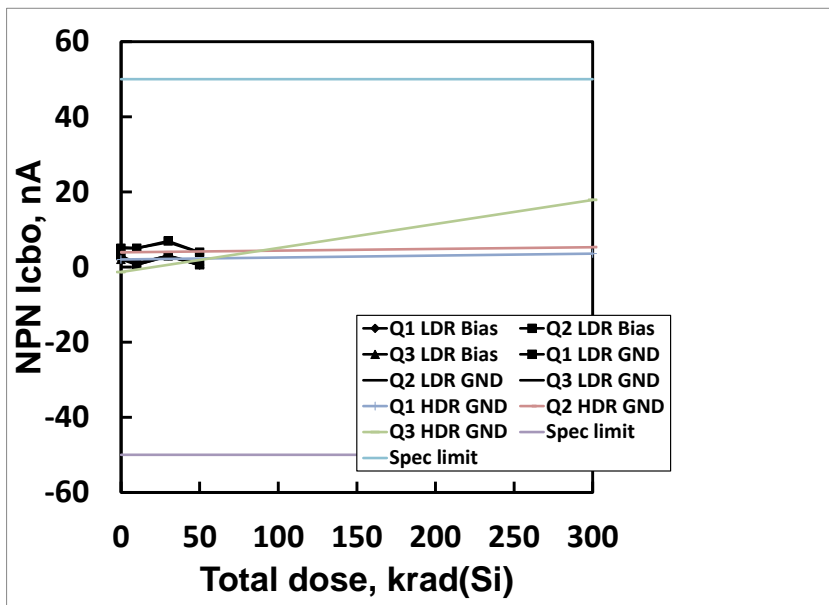

Fig. 11: ISL73096EH NPN collector-base leakage current (I_{cbo}), devices Q1 through Q3, plotted as a function of low dose rate irradiation for the biased (per Figure 1) and unbiased (all pins grounded) cases and for high dose rate irradiation for the biased (per Fig. 1) case. The low dose rate was 0.01 rad(Si)/s and the high dose rate was 65rad(Si)/s. Sample size for the low dose rate cells was 24 and sample for the high dose rate cell was 36. The internal Intersil limits are -50.0nA to +50.0nA maximum, while the post-irradiation limits are also -50.0nA to +50.0nA maximum. The parameter is not specified in the SMD.

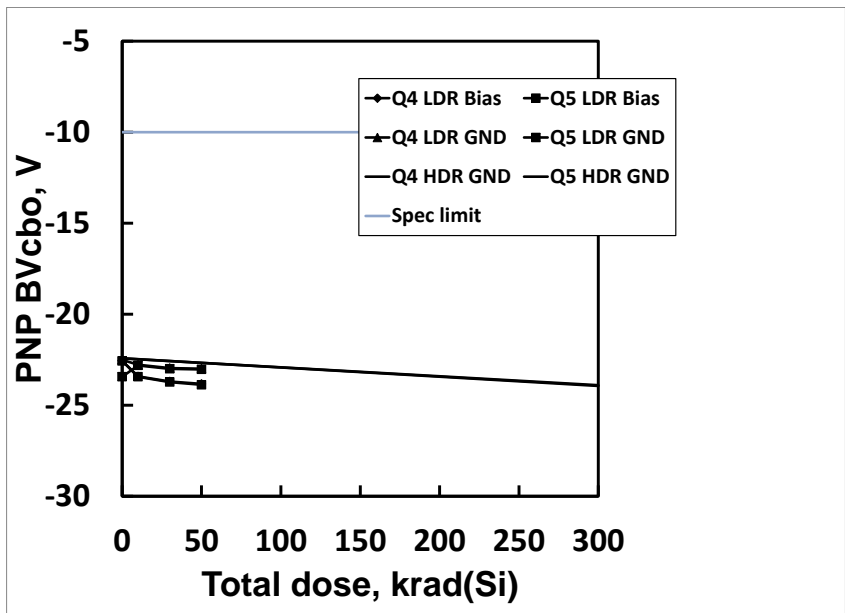

Fig. 12: ISL73096EH PNP collector-base breakdown voltage (BVcbo), devices Q4 and Q5, plotted as a function of low dose rate irradiation for the biased (per Figure 1) and unbiased (all pins grounded) cases and for high dose rate irradiation for the biased (per Fig. 1) case. The low dose rate was 0.01 rad(Si)/s and the high dose rate was 65rad(Si)/s. Sample size for the low dose rate cells was 24 and sample for the high dose rate cell was 36. The pre-irradiation SMD limit is -10.0V minimum, while the post-irradiation SMD limit is also -10.0V minimum.

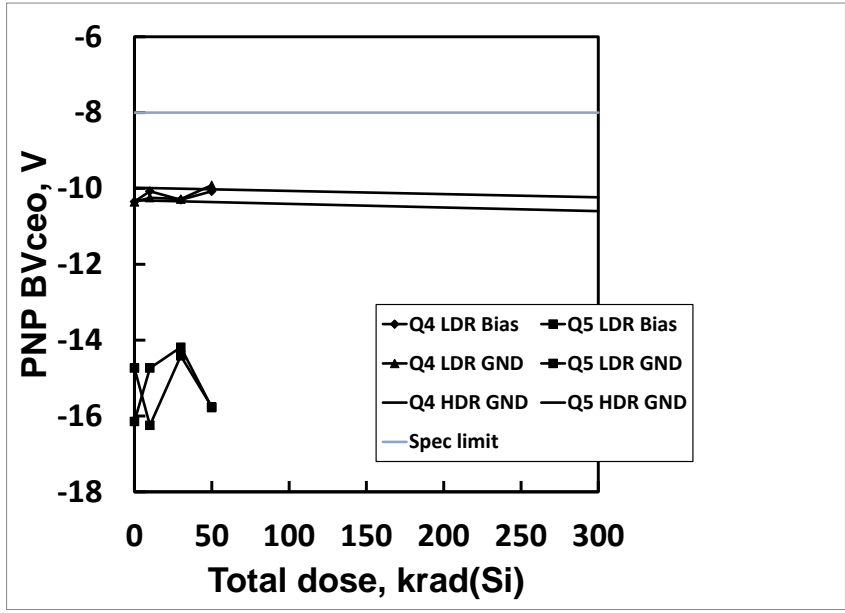

Fig. 13: ISL73096EH PNP collector-emitter breakdown voltage (BVceo), devices Q4 and Q5, plotted as a function of low dose rate irradiation for the biased (per Figure 1) and unbiased (all pins grounded) cases and for high dose rate irradiation for the biased (per Fig. 1) case. The low dose rate was 0.01 rad(Si)/s and the high dose rate was 65rad(Si)/s. Sample size for the low dose rate cells was 24 and sample for the high dose rate cell was 36. The pre-irradiation SMD limit is -8.0V minimum, while the post-irradiation SMD limit is also -8.0V minimum.

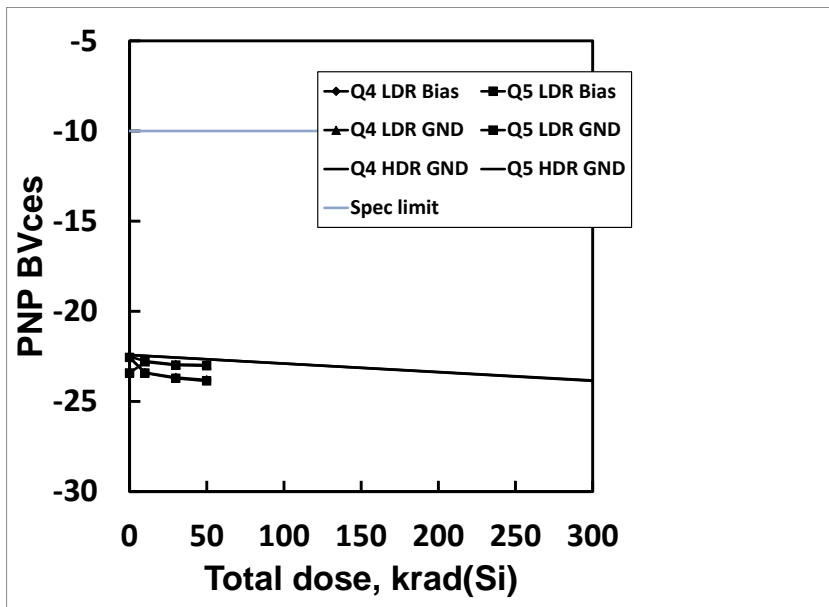

Fig. 14: ISL73096EH PNP collector-emitter breakdown voltage (BVces), devices Q4 and Q5, plotted as a function of low dose rate irradiation for the biased (per Figure 1) and unbiased (all pins grounded) cases and for high dose rate irradiation for the biased (per Fig. 1) case. The low dose rate was 0.01 rad(Si)/s and the high dose rate was 65rad(Si)/s. Sample size for the low dose rate cells was 24 and sample for the high dose rate cell was 36. The pre-irradiation SMD limit is -10.0V minimum, while the post-irradiation SMD limit is also -10.0V minimum.

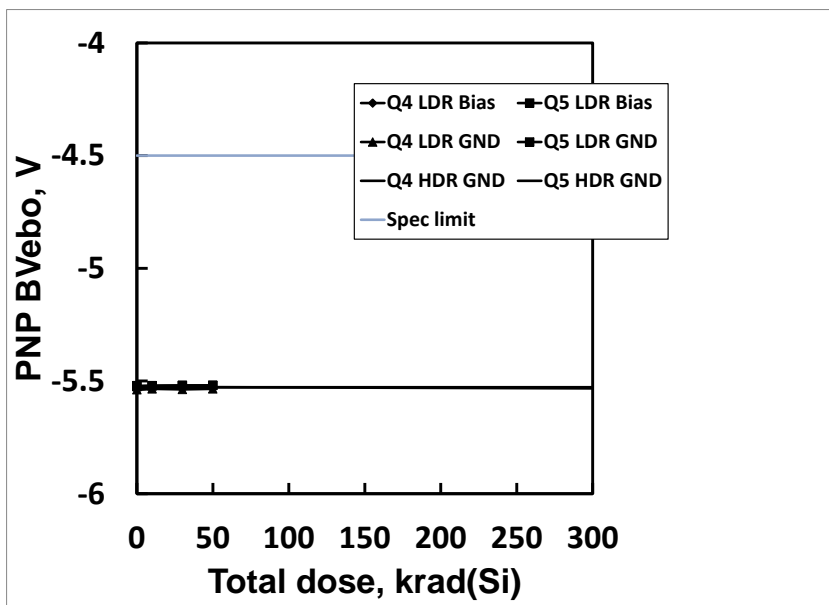

Fig. 15: ISL73096EH PNP emitter-base breakdown voltage (BVebo), devices Q4 and Q5, plotted as a function of low dose rate irradiation for the biased (per Figure 1) and unbiased (all pins grounded) cases and for high dose rate irradiation for the biased (per Fig. 1) case. The low dose rate was 0.01 rad(Si)/s and the high dose rate was 65rad(Si)/s. Sample size for the low dose rate cells was 24 and sample for the high dose rate cell was 36. The pre-irradiation SMD limit is -4.5V minimum, while the post-irradiation SMD limit is also -4.5V minimum.

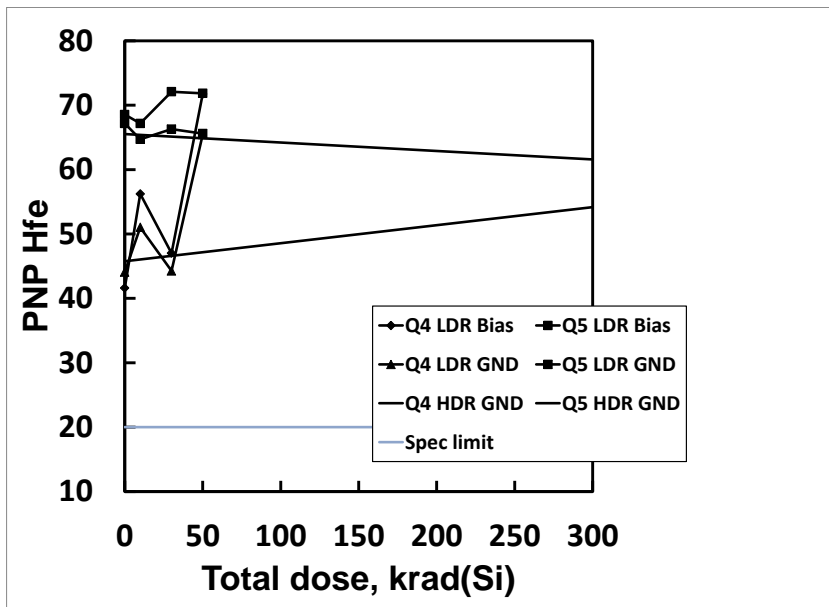

Fig. 16: ISL73096EH PNP common-emitter current gain (Hfe) at $I_c = 10.0\text{mA}$ and $V_{ce} = 2.0\text{V}$, devices Q4 and Q5, plotted as a function of low dose rate irradiation for the biased (per Figure 1) and unbiased (all pins grounded) cases and for high dose rate irradiation for the biased (per Fig. 1) case. The low dose rate was 0.01 rad(Si)/s and the high dose rate was 65rad(Si)/s . Sample size for the low dose rate cells was 24 and sample for the high dose rate cell was 36. The pre-irradiation SMD limit is 40 minimum, while the post-irradiation SMD limit is 20 minimum. Current gain is a dimensionless parameter.

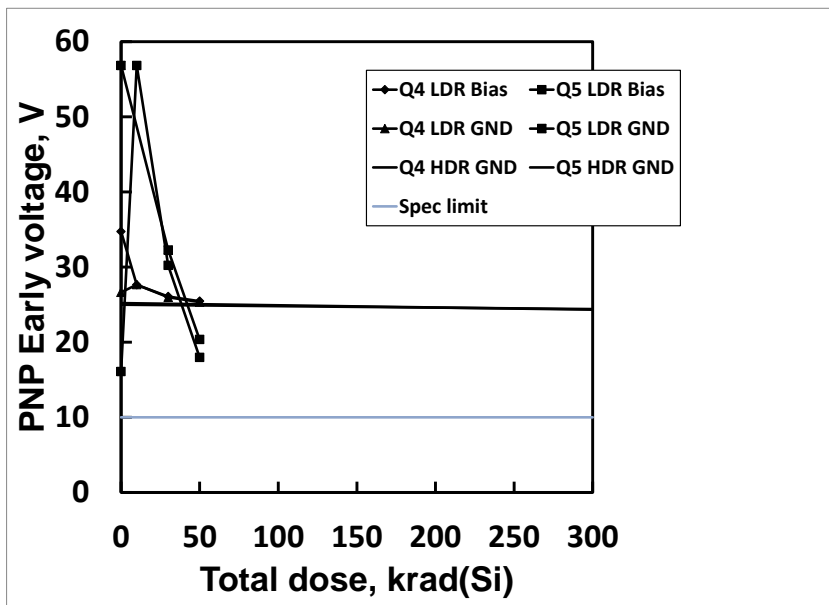

Fig. 17: ISL73096EH PNP Early voltage (V_A), devices Q4 and Q5, plotted as a function of low dose rate irradiation for the biased (per Figure 1) and unbiased (all pins grounded) cases and for high dose rate irradiation for the biased (per Fig. 1) case. The low dose rate was 0.01 rad(Si)/s and the high dose rate was 65rad(Si)/s . Sample size for the low dose rate cells was 24 and sample for the high dose rate cell was 36. The pre-irradiation SMD limit is 10.0V minimum, while the post-irradiation SMD limit is also 10.0V minimum.

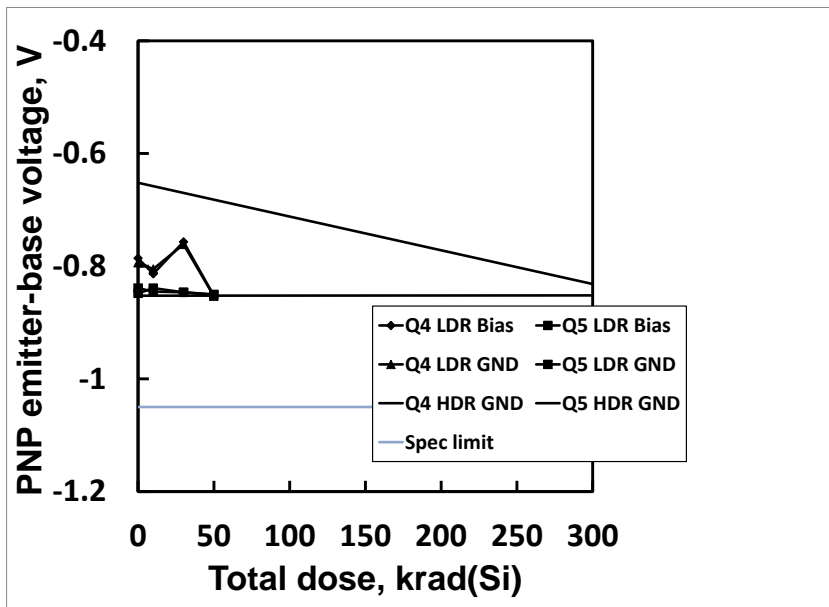

Fig. 18: ISL73096EH PNP emitter-base voltage (V_{be}) at 10.0mA, devices Q4 and Q5, plotted as a function of low dose rate irradiation for the biased (per Figure 1) and unbiased (all pins grounded) cases and for high dose rate irradiation for the biased (per Fig. 1) case. The low dose rate was 0.01 rad(Si)/s and the high dose rate was 65rad(Si)/s. Sample size for the low dose rate cells was 24 and sample for the high dose rate cell was 36. The pre-irradiation SMD limit is -0.95V maximum, while the post-irradiation SMD limit is -1.05V maximum.

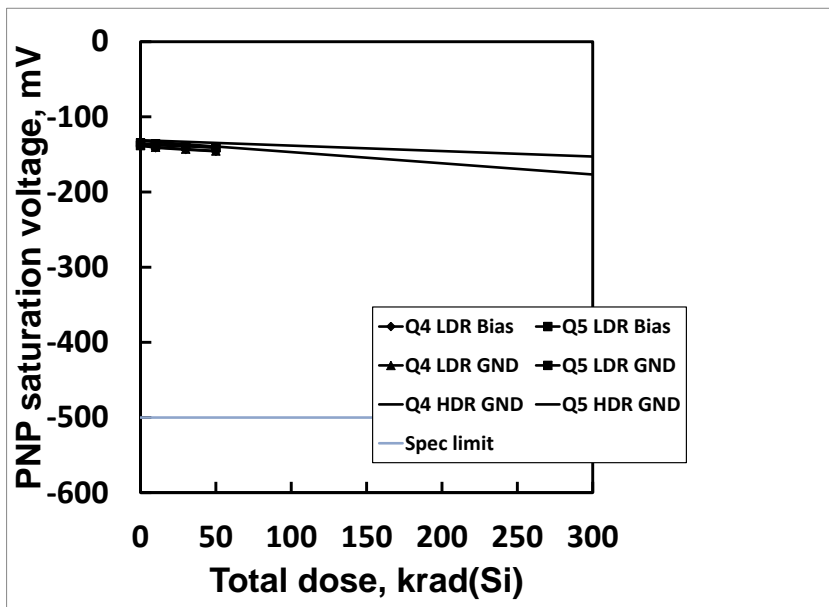

Fig. 19: ISL73096EH PNP collector-emitter saturation voltage ($V_{ce(sat)}$), devices Q4 and Q5, plotted as a function of low dose rate irradiation for the biased (per Figure 1) and unbiased (all pins grounded) cases and for high dose rate irradiation for the biased (per Fig. 1) case. The low dose rate was 0.01 rad(Si)/s and the high dose rate was 65rad(Si)/s. Sample size for the low dose rate cells was 24 and sample for the high dose rate cell was 36. The pre-irradiation SMD limit is -500.0mV maximum, while the post-irradiation SMD limit is also -500.0mV maximum.

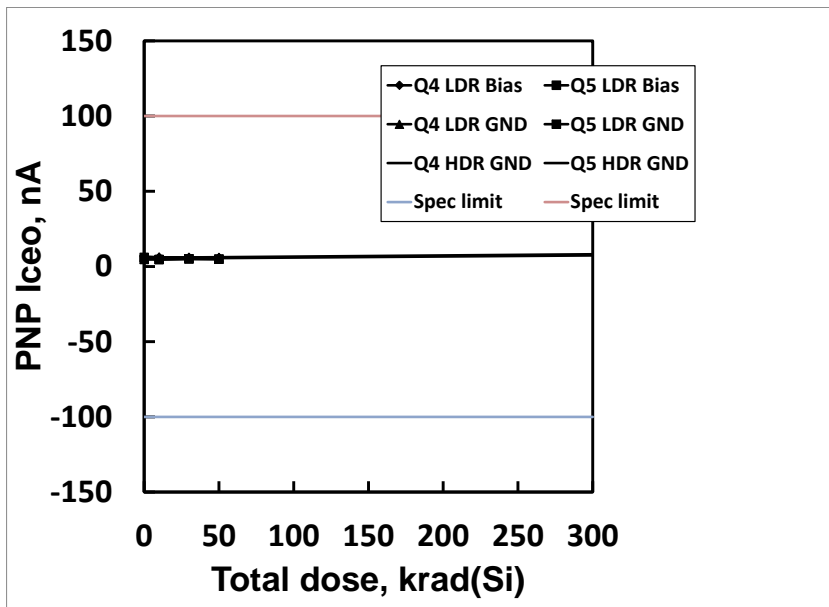

Fig. 20: ISL73096EH PNP collector-emitter leakage current (I_{ceo}), devices Q4 and Q5, plotted as a function of low dose rate irradiation for the biased (per Figure 1) and unbiased (all pins grounded) cases and for high dose rate irradiation for the biased (per Fig. 1) case. The low dose rate was 0.01 rad(Si)/s and the high dose rate was 65rad(Si)/s. Sample size for the low dose rate cells was 24 and sample for the high dose rate cell was 36. The internal Intersil limits are -100.0nA to +100.0nA maximum, while the post-irradiation limits are also -100.0nA to +100.0nA maximum. The parameter is not specified in the SMD.

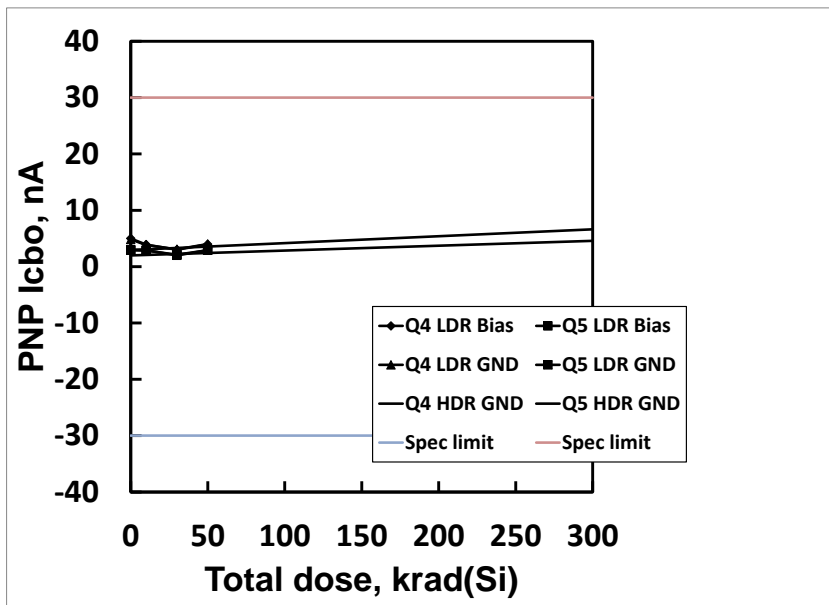

Fig. 21: ISL73096EH PNP collector-base leakage current (I_{cbo}), devices Q4 and Q5, plotted as a function of low dose rate irradiation for the biased (per Figure 1) and unbiased (all pins grounded) cases and for high dose rate irradiation for the biased (per Fig. 1) case. The low dose rate was 0.01 rad(Si)/s and the high dose rate was 65rad(Si)/s. Sample size for the low dose rate cells was 24 and sample for the high dose rate cell was 36. The internal Intersil limits are -30.0nA to +30.0nA maximum, while the post-irradiation limits are also -30.0nA to +30.0nA maximum. The parameter is not specified in the SMD.

6: Conclusion

This document reports results of low and high dose rate testing of the ISL73096EH NPN/PNP transistor array. Parts were irradiated at 0.01 rad(Si)/s under biased and unbiased conditions and at 65rad(Si)/s under biased conditions per MIL-STD-883 Test Method 1019.7. The low dose rate tests were run to 50 krad(Si) and the high dose rate test was run to 300 krad(Si). All parameters showed excellent stability and remained within the pre- and post-irradiation limits at all downpoints. No device sensitivity (meaning measurable differences in irradiation response between transistors on the same die, the equivalent of channel sensitivity in for example multichannel operational amplifiers) was noted at any of the downpoints. Similarly we saw no dose rate or bias sensitivity at all, and the part is not considered to be low dose rate sensitive.

7: Appendices

7.1: Reported parameters and their post-radiation SMD limits.

Fig.	Type	Parameter	Limit, low	Limit, high	Units	Notes
2	NPN	Collector-base breakdown voltage	12.0	-	V	Emitter open, Ic = 100 µA
3	NPN	Collector-emitter breakdown voltage	8.0	-	V	Base open, Ic = 100µA
4	NPN	Collector-emitter breakdown voltage	10.0	-	V	Base tied to emitter, Ic = 100µA
5	NPN	Emitter-base breakdown voltage	5.5	-	V	Ie = 10 µA
6	NPN	Common-emitter current gain	40	-	-	Ic = 10 mA, Vce = 2.0 V
7	NPN	Early voltage	20.0	-	V	Ic = 1 mA, Vce = 3.5 V
8	NPN	Emitter-base voltage	1.05	-	V	Ie = 10.0 mA
9	NPN	Collector-emitter saturation voltage	500.0	-	mV	Ic = 10 mA, Ib = 1 mA
10	NPN	Collector-emitter leakage	-100.0	+100.0	nA	
11	NPN	Collector-base leakage	-50.0	+50.0	nA	
12	PNP	Collector-base breakdown voltage	10.0	-	V	Emitter open, Ic = 100 µA
13	PNP	Collector-emitter breakdown voltage	8.0	-	V	Base open, Ic = 100µA
14	PNP	Collector-emitter breakdown voltage	10.0	-	V	Base tied to emitter, Ic = 100µA
15	PNP	Emitter-base breakdown voltage	4.5	-	V	Ie = 10 µA
16	PNP	Common-emitter current gain	20	200	-	Ic = 10 mA, Vce = 2.0 V
17	PNP	Early voltage	10.0	-	V	Ic = 1 mA, Vce = 3.5 V
18	PNP	Emitter-base voltage	1.05	-	V	Ie = 10.0 mA
19	PNP	Collector-emitter saturation voltage	500.0	-	mV	Ic = 10 mA, Ib = 1 mA
20	PNP	Collector-emitter leakage	-100.0	+100.0	nA	
21	PNP	Collector-base leakage	-30.0	+30.0	nA	

8: Document revision history

Revision	Date	Pages	Comments
0	29 May 2014	All	Original issue