

ISL73041SEH

High Dose Rate Total Ionizing Dose Testing of the ISL73041SEH 12V Half Bridge GaN FET Driver

Introduction

This report summarizes the results of high dose rate (HDR) total ionizing dose (TID) testing of the ISL73041SEH 12V Half Bridge GaN FET Driver. The test was conducted to provide an assessment of the total dose hardness of the part and to provide an estimate of the bias sensitivity. Parts were irradiated either under bias or with all pins grounded at HDR (73rad(Si)/s) to 150krad(Si). All irradiations were followed by a 168-hour biased anneal at a 100°C. The [ISL73041SEH](#) is rated to 75krad(Si) at low dose rate (LDR) and is acceptance tested on a wafer-by-wafer basis to the datasheet limits. The ISL73041SEH is not rated for HDR.

Product Description

The ISL73041SEH is a radiation hardened PWM input 12V Half Bridge GaN FET Driver designed to drive low $r_{DS(ON)}$ enhancement Gallium Nitride (eGaN) FETs for DC/DC switching regulators. An integrated programmable GaN FET gate drive voltage, high-side bootstrap switch, and strong gate drive current provide a compact and robust GaN FET half-bridge driver.

The ISL73041SEH can interface directly to the ISL73847SEH dual-phase PWM buck controller to create a high-efficiency point-of-load regulator to power many of the latest low voltage, high current FPGA and DSP digital core rails.

The ISL73041SEH operates across the military temperature range from -55°C to +125°C and is available in a 16 Pad Ceramic Leadless Chip Carrier (CLCC) package. [Figure 1](#) shows the pin assignments for the ISL73041SEH, and [Table 1](#) shows the pin descriptions.

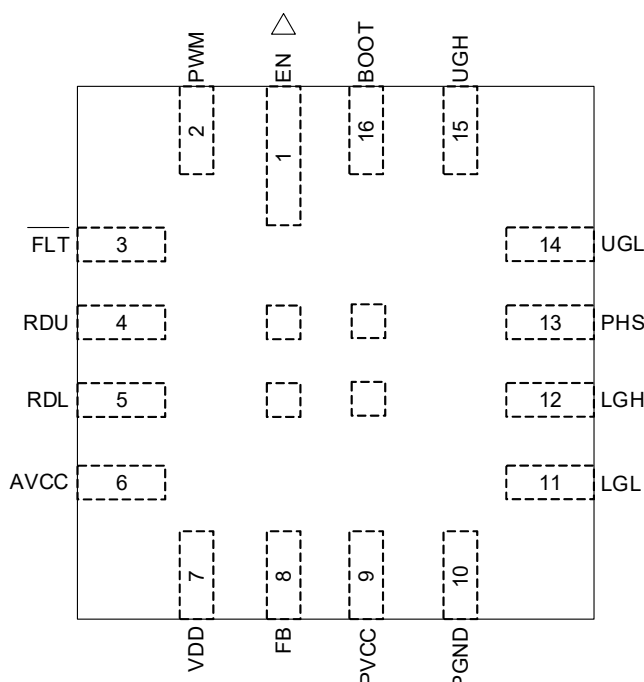

Figure 1. Pin Assignments

Table 1. ISL73041SEH Pin Descriptions

Pin Number	Pin Name	Description
1	EN	Enable input pin. When EN is low, driver outputs are in a high-impedance state and do not respond to PWM inputs. The PVCC LDO is shut down, and the $\overline{\text{FLT}}$ pin is internally pulled low. When EN is high, the PVCC LDO is enabled, and the driver outputs respond to PWM inputs. EN pin is VDD voltage compliant.
2	PWM	Tri-Level PWM input pin. Logic high turns on the high-side gate driver. Logic low turns on the low-side gate driver. Mid-Level turns off both gate drivers. Internal pull-up and pull-down resistors bias pin to mid-level when not externally driven.
3	$\overline{\text{FLT}}$	I/O pin. As an open-drain output, $\overline{\text{FLT}}$ is an active low indicator for when EN=0, VDD UVLO, AVCC UVLO, PVCC UVLO, or in an over-temperature fault. As a high-impedance input, $\overline{\text{FLT}}$ disables the driver outputs when driven low. Place a pull-up resistor on the $\overline{\text{FLT}}$ pin to AVCC. Place a 10pF capacitor from $\overline{\text{FLT}}$ to GND for SET mitigation.
4	RDU	Dead time delay control for the high-side turn-on. A 1k Ω -10k Ω resistor to SGND sets the rising edge delay of Upper Gate High (UGH) to the falling edge of Lower Gate Low (LGL) in the range of 5ns to 50ns. Connect RDU to SGND for 5ns delay.
5	RDL	Dead time delay control for low-side turn-on. A 1k Ω -10k Ω resistor to SGND sets the rising edge delay of Lower Gate High (LGH) to the falling edge of Upper Gate Low (UGL) in the range of 5ns to 50ns. Connect RDL to SGND for 5ns delay.
6	AVCC	The output of the internal 5V LDO regulator for chip bias. Input is VDD. A minimum of 1 μ F ceramic decoupling capacitor is necessary on AVCC to SGND.
7	VDD	Input supply to chip. The recommended bias range is 4.75V to 18V.
8	FB	PVCC LDO error amplifier inverting input. A resistor divider network from FB to PVCC and SGND sets the PVCC LDO output voltage. If FB is connected to PVCC, PVCC output voltage is 4.5V.
9	PVCC	The output of the LDO for the gate drive voltage. The recommended PVCC range is 4.5V to 5.5V. A minimum 1 μ F ceramic decoupling capacitor is necessary on PVCC to PGND.
10	PGND	Low-side driver output reference pin. Anti-parallel diodes are connected between SGND and PGND.
11	LGL	Low-side sink driver for gate turn-off. Connect this pin to LGH and the GaN FET gate.
12	LGH	Low-side source driver for gate turn-on. Connect this pin to LGL and the GaN FET gate.
13	PHS	High-side GaN FET source reference. Connect to the phase-switching node of the half-bridge.
14	UGL	High-side sink driver for gate turn-off. Connect this pin to UGH and the GaN FET gate.
15	UGH	High-side source driver for gate turn-on. Connect this pin to UGL and the GaN FET gate.
16	BOOT	High-side bootstrap bias pin. Connect a bootstrap capacitor from this pin to PHS. An internal bootstrap switch connects PVCC to BOOT when PWM = 0V and PHS voltage is within 250mV of PGND.
PAD	SGND	Analog ground pin. Connect the four bottom pads of the package common to PGND. The die substrate is electrically connected to PAD. Anti-parallel diodes are connected between SGND and PGND.
LID	SGND	The package lid is internally connected to the four bottom pads, die substrate, and SGND.

Contents

1. Test Description	4
1.1 Irradiation Facility	4
1.2 Test Fixturing	4
1.3 Characterization Equipment and Procedures	4
1.4 Experimental Matrix	4
1.5 Downpoints	5
2. Results	5
2.1 Attributes Data	5
2.2 Variables Data	5
3. Discussion and Conclusion	20
4. Revision History	20
A. Appendix	21

1. Test Description

1.1 Irradiation Facility

HDR testing was performed on November 22, 2022, at a 73rad(Si)/s dose rate using a Gammacell 220 irradiator. The irradiator is located in the Palm Bay, Florida, Renesas facility. A PbAl box was used to shield the test fixture and devices under test against low energy and secondary gamma radiation. Post-irradiation annealing was performed under bias in a small temperature chamber.

1.2 Test Fixturing

Figure 2 shows the configuration used for the biased TID testing and anneals.

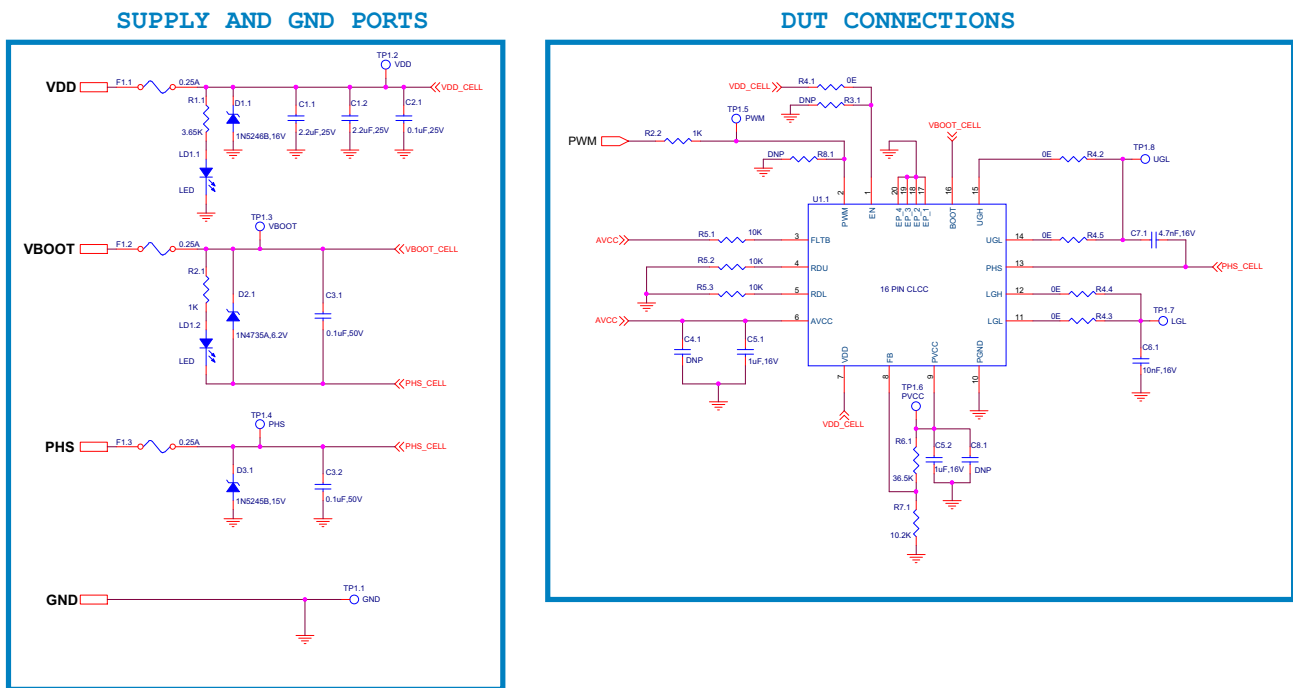

Figure 2. Bias Configuration

1.3 Characterization Equipment and Procedures

All electrical testing was performed outside the irradiator using the production Automated Test Equipment (ATE) with data logging at each downpoint. Downpoint electrical testing was performed at room temperature.

1.4 Experimental Matrix

Irradiation was performed in accordance with the guidelines of MIL-STD-883 Test Method 1019. The experimental matrix consisted of two irradiated under bias and two irradiated with all pins grounded. After irradiation, all parts were also subjected to a 168-hour, 100°C biased anneal. During the anneal, the Palm Bay facility experienced a power outage, damaging one that was biased during irradiation. The data from this part was omitted from the anneal measurements. There were two control units.

The samples for HDR testing were all drawn from wafer lot F6V879. All samples were packaged in the 16 Pad CLCC.

1.5 Downpoints

The planned irradiation downpoints for the HDR test were 0krad(Si), 10krad(Si), 30krad(Si), 50krad(Si), 75krad(Si), 100krad(Si), and 150krad(Si). The irradiations were followed by a 168-hour high-temperature anneal at 100°C under bias.

2. Results

TID testing of the ISL73041SEH is complete. All tested parameters passed the datasheet limits. [Table 2](#) summarizes the results.

2.1 Attributes Data

Table 2. ISL73041SEH Attributes Data

Dose Rate (rad(Si)/s)	Condition	Sample Size ^[1]	Downpoint	Pass ^[2]	Fail
73	Biased (Figure 2)	2	Pre-irradiation	2	0
			10krad(Si)	2	0
			30krad(Si)	2	0
			50krad(Si)	2	0
			75krad(Si)	2	0
			100krad(Si)	2	0
			150krad(Si)	2	0
			Anneal	1	0
73	Grounded	2	Pre-irradiation	2	0
			10krad(Si)	2	0
			30krad(Si)	2	0
			50krad(Si)	2	0
			75krad(Si)	2	0
			100krad(Si)	2	0
			150krad(Si)	2	0
			Anneal	2	0

1. During the anneal, the Palm Bay facility experienced a power outage damaging one device which experienced biased HDR irradiation. The data from this part was omitted from the anneal measurements.

2. A Pass indicates a sample that passes all datasheet limits.

2.2 Variables Data

The plots in [Figure 3](#) through [Figure 30](#) illustrate the HDR response of the selected parameters shown in [Table 3](#) in the Appendix. The plots show the average tested values of the parameters as a function of the total dose for each irradiation condition, biased and grounded, plus a 168-hour, 100°C biased anneal. The plots also include error bars at each downpoint, representing the samples' minimum and maximum measured values. However, in some plots, the error bars might not be visible due to their values compared to the scale of the graph.

During the anneal, the Palm Bay facility experienced a power outage, damaging one device that experienced biased HDR irradiation. The data from this part was omitted from the anneal measurements.

All samples passed the datasheet limits after irradiation up to 150krad(Si), and the subsequent anneal. The HDR data are provided for guidance only as the ISL73041SEH is only acceptance tested to 75krad(Si) at LDR.

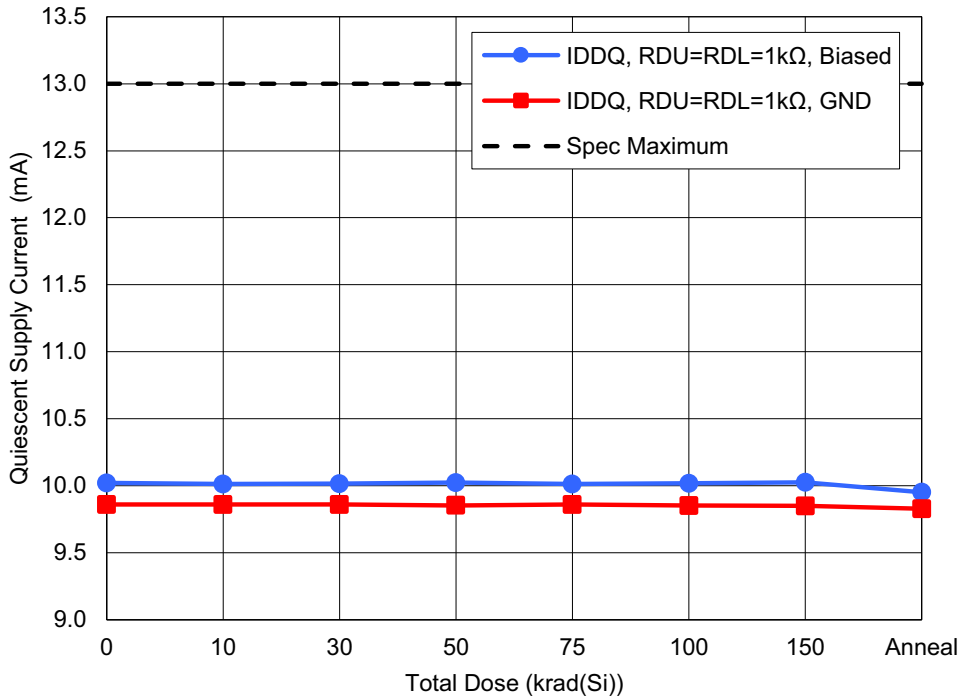

Figure 3. ISL73041SEH quiescent supply current (I_{DDQ}) with $V_{DD} = 13.2V$, $EN = V_{DD}$, $PWM = Float$, and $RDU = RDL = 1k\Omega$ to GND as a function of HDR irradiation and anneal for biased and grounded configurations. The error bars (if visible) represent the minimum and maximum measured values. The datasheet limit is a maximum of 13mA.

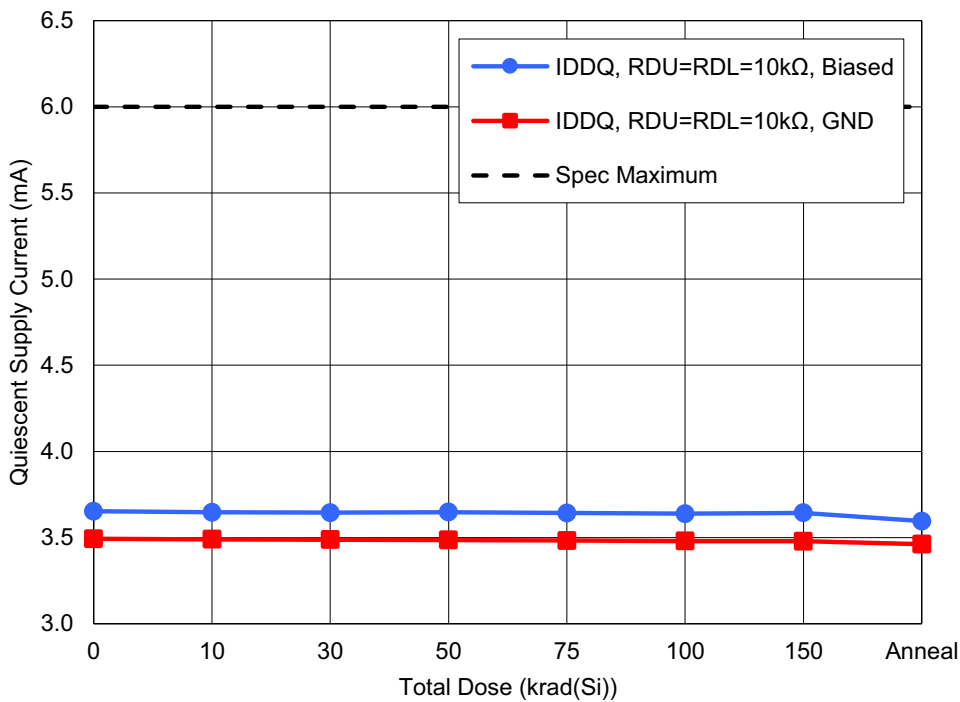

Figure 4. ISL73041SEH quiescent supply current (I_{DDQ}) with $V_{DD} = 13.2V$, $EN = V_{DD}$, $PWM = Float$, and $RDU = RDL = 10k\Omega$ to GND as a function of HDR irradiation and anneal for biased and grounded configurations. The error bars (if visible) represent the minimum and maximum measured values. The datasheet limit is a maximum of 6mA.

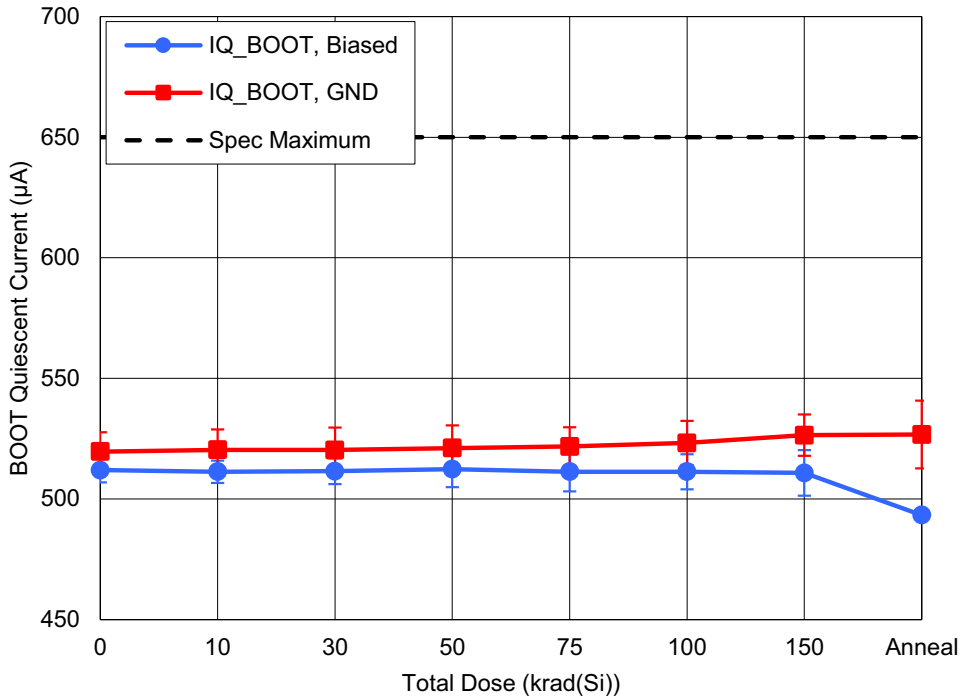

Figure 5. ISL73041SEH BOOT quiescent supply current (I_{Q_BOOT}) with $V_{DD} = 13.2V$, $EN = V_{DD}$, $PWM = Float$, and $BOOT-PHS = 4.5V$ as a function of HDR irradiation and anneal for biased and grounded configurations. The error bars (if visible) represent the minimum and maximum measured values. The datasheet limit is a maximum of $650\mu A$.

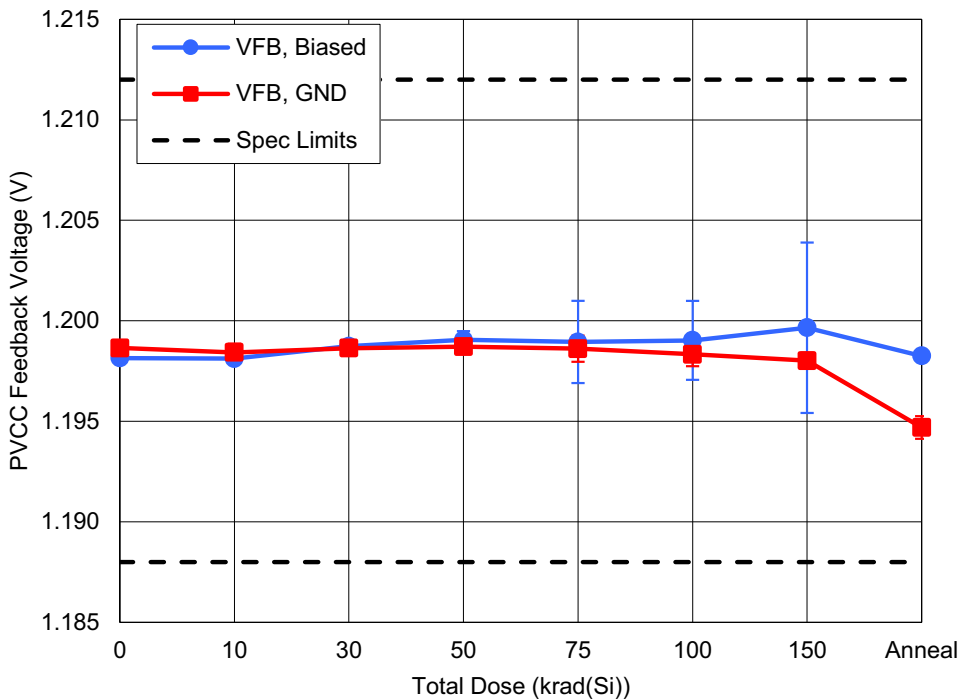

Figure 6. ISL73041SEH PVCC feedback voltage (V_{FB}) with $V_{DD} = 13.2V$ as a function of HDR irradiation and anneal for biased and grounded configurations. The error bars (if visible) represent the minimum and maximum measured values. The datasheet limits are a minimum of $1.188V$ and a maximum of $1.212V$.

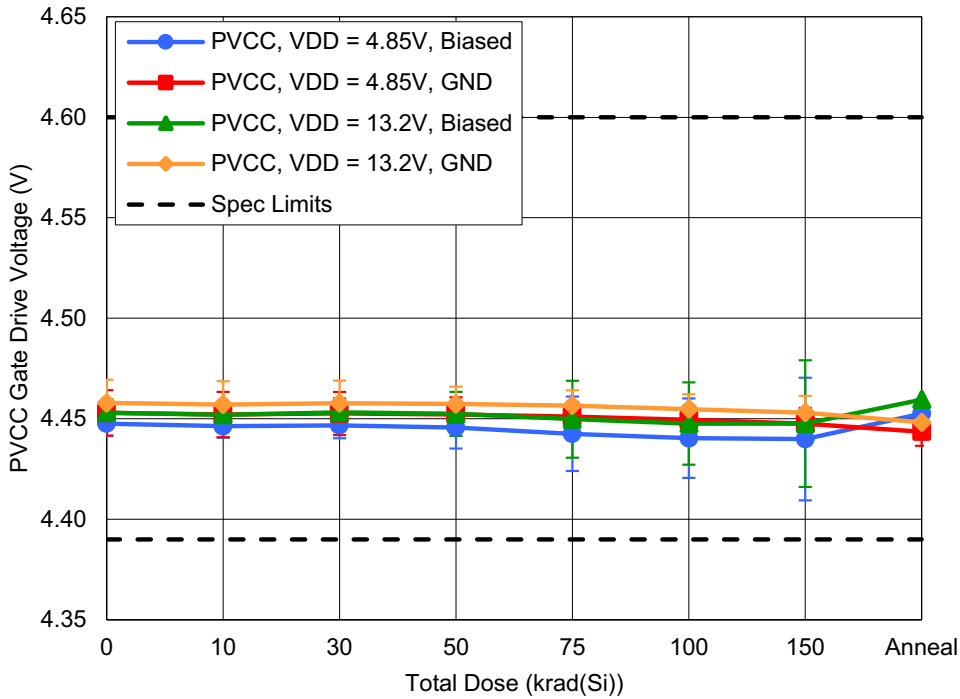

Figure 7. ISL73041SEH PVCC gate drive voltage (PVCC) with $V_{DD} = 4.85V$ or $13.2V$, $FB = PVCC$, and $I_{OUT} = 150mA$ as a function of HDR irradiation and anneal for biased and grounded configurations. The error bars (if visible) represent the minimum and maximum measured values. The datasheet limits are a minimum of $4.39V$ and a maximum of $4.6V$.

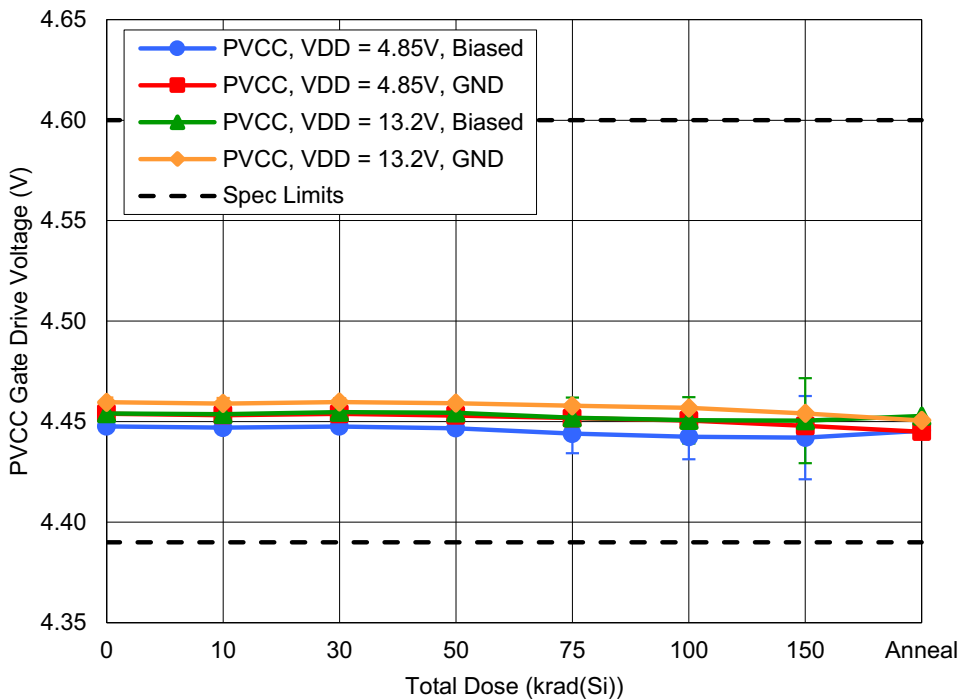

Figure 8. ISL73041SEH PVCC gate drive voltage (PVCC) with $V_{DD} = 4.85V$ or $13.2V$, $FB = 0.266 \cdot PVCC$, and $I_{OUT} = 150mA$ as a function of HDR irradiation and anneal for biased and grounded configurations. The error bars (if visible) represent the minimum and maximum measured values. The datasheet limits are a minimum of $4.39V$ and a maximum of $4.6V$.

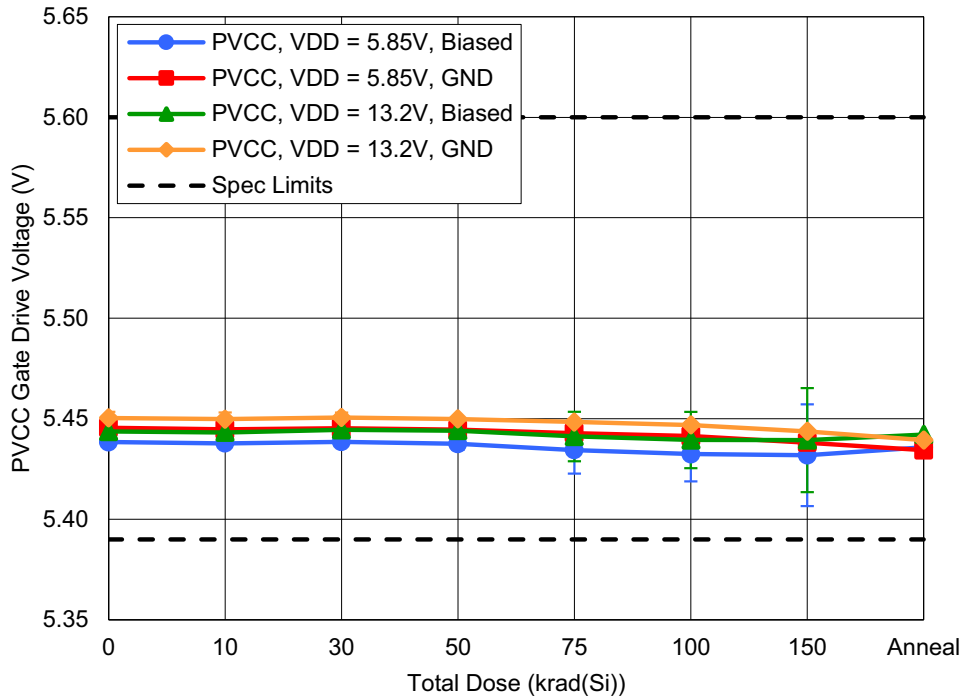

Figure 9. ISL73041SEH PVCC gate drive voltage (PVCC) with $V_{DD} = 5.85V$ or $13.2V$, $FB = 0.218 \cdot PVCC$, and $I_{OUT} = 150mA$ as a function of HDR irradiation and anneal for biased and grounded configurations. The error bars (if visible) represent the minimum and maximum measured values. The datasheet limits are a minimum of $5.39V$ and a maximum of $5.6V$.

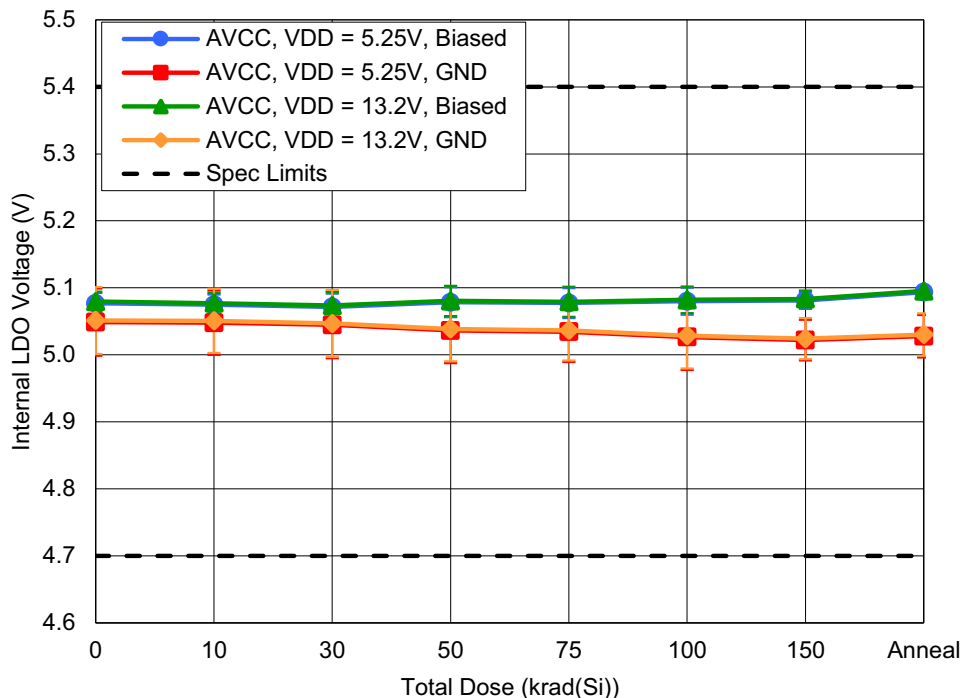

Figure 10. ISL73041SEH internal LDO voltage (AVCC) with $V_{DD} = 5.25V$ or $13.2V$, and with $I_{OUT} = 20mA$ as a function of HDR irradiation and anneal for biased and grounded configurations. The error bars (if visible) represent the minimum and maximum measured values. The datasheet limits are a minimum of $4.7V$ and a maximum of $5.4V$.

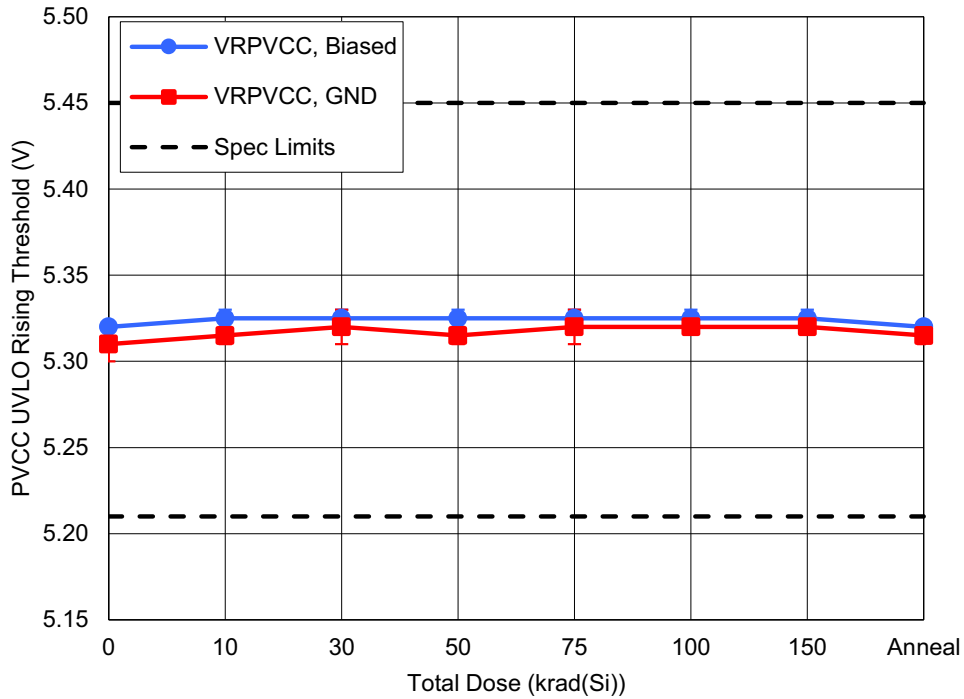

Figure 11. ISL73041SEH PVCC UVLO rising threshold ($V_{R_{PVCC}}$) with $V_{DD} = 13.2V$, $PVCC = 5.5V$ and with external FB resistors, as a function of HDR irradiation and anneal for biased and grounded configurations. The error bars (if visible) represent the minimum and maximum measured values. The datasheet limits are a minimum of 5.21V and a maximum of 5.45V.

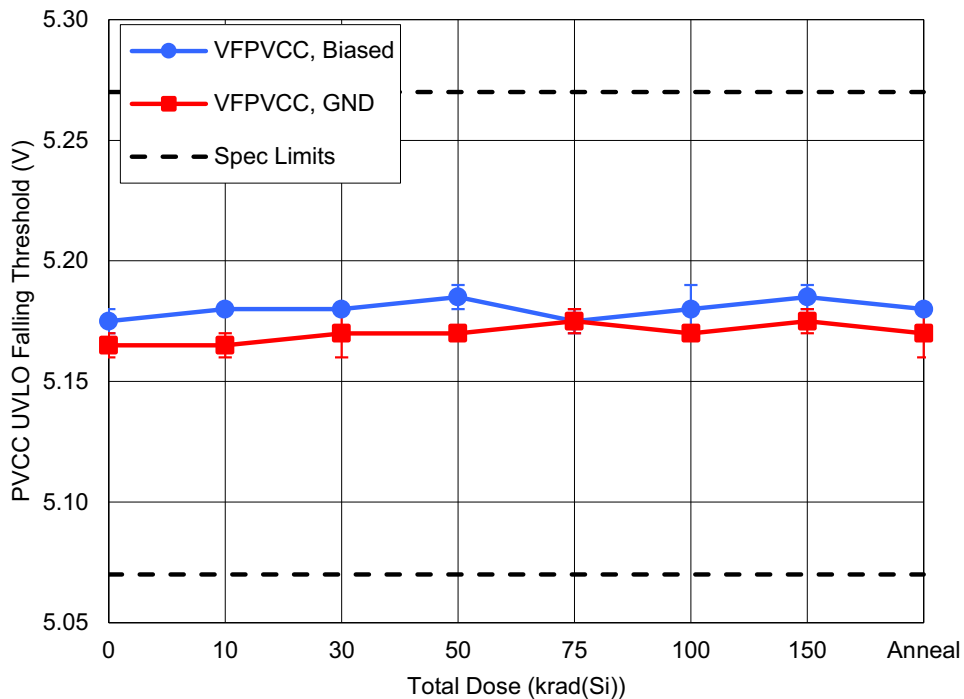

Figure 12. ISL73041SEH PVCC UVLO falling threshold ($V_{F_{PVCC}}$) with $V_{DD} = 13.2V$, $PVCC = 5.5V$ and with external FB resistors as a function of HDR irradiation and anneal for biased and grounded configurations. The error bars (if visible) represent the minimum and maximum measured values. The datasheet limits are a minimum of 5.07V and a maximum of 5.27V.

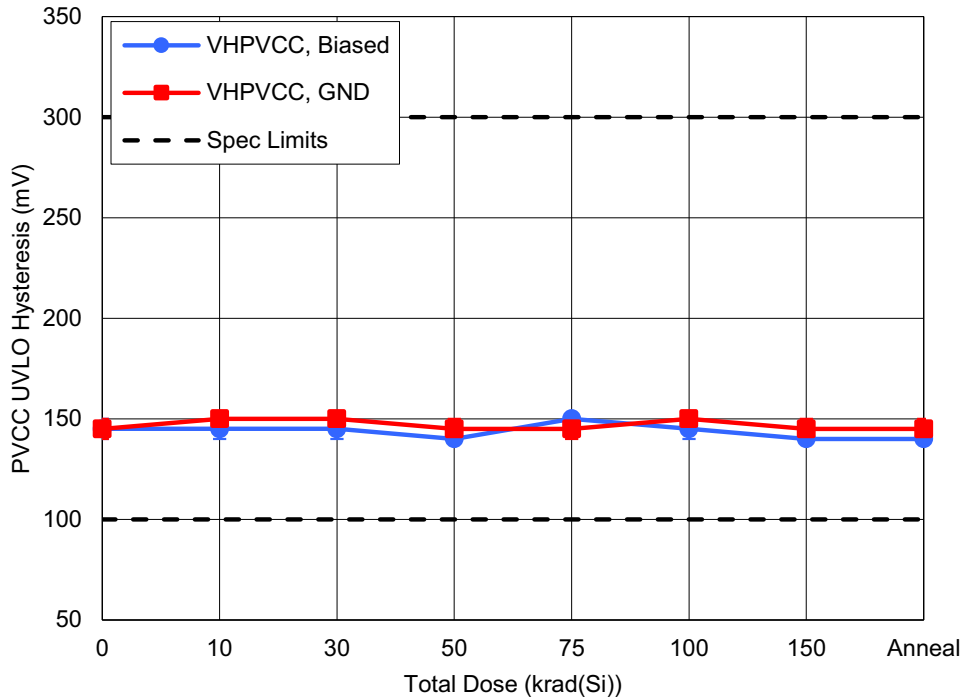

Figure 13. ISL73041SEH PVCC UVLO hysteresis ($V_{H_{PVCC}}$) with $V_{DD} = 13.2V$ as a function of HDR irradiation and anneal for biased and grounded configurations. The error bars (if visible) represent the minimum and maximum measured values. The datasheet limits are a minimum of 100mV and a maximum of 300mV.

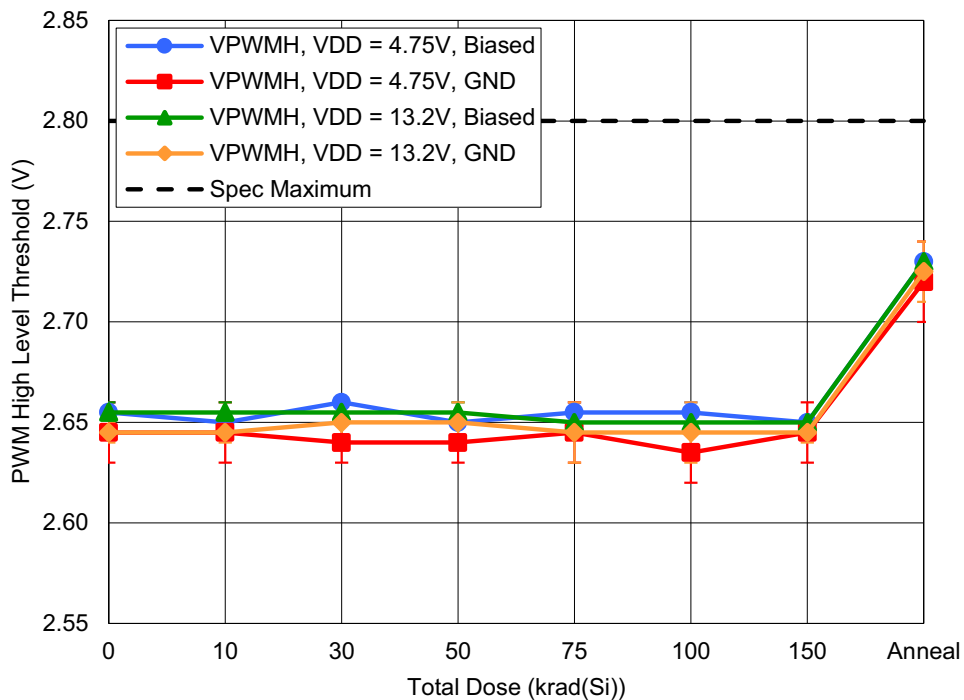

Figure 14. ISL73041SEH PWM high level threshold ($V_{P_{WMH}}$) with $V_{DD} = 4.75V$ or $13.2V$ as a function of HDR irradiation and anneal for biased and grounded configurations. The error bars (if visible) represent the minimum and maximum measured values. The datasheet limit is a maximum of 2.8V.

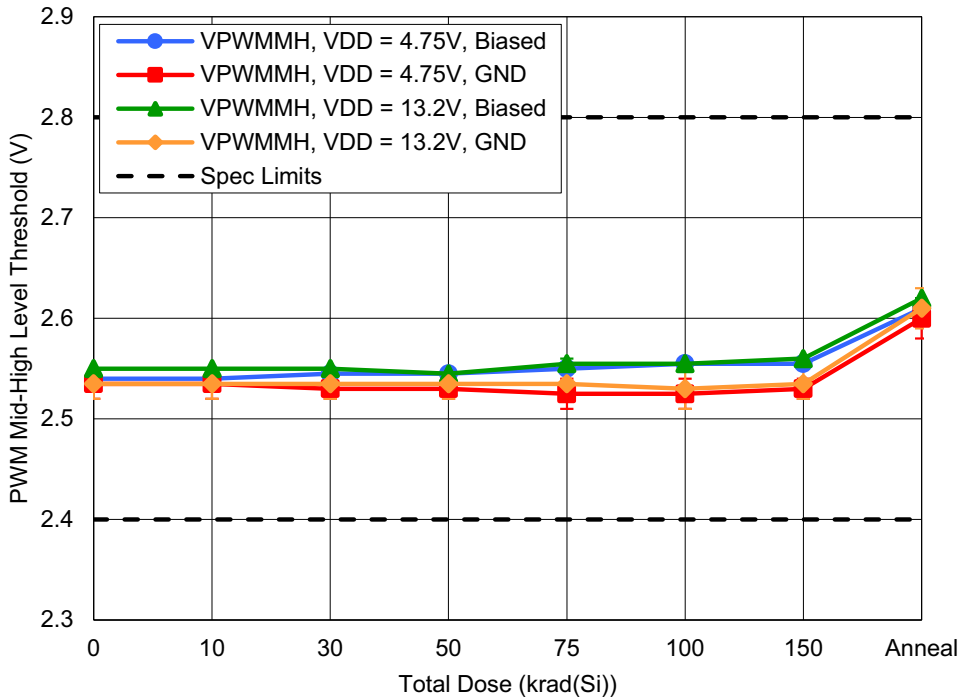

Figure 15. ISL73041SEH PWM high mid-level threshold (V_{PWMMH}) with $V_{DD} = 4.75V$ or $13.2V$ as a function of HDR irradiation and anneal for biased and grounded configurations. The error bars (if visible) represent the minimum and maximum measured values. The datasheet limits are a minimum of $2.4V$ and a maximum of $2.8V$.

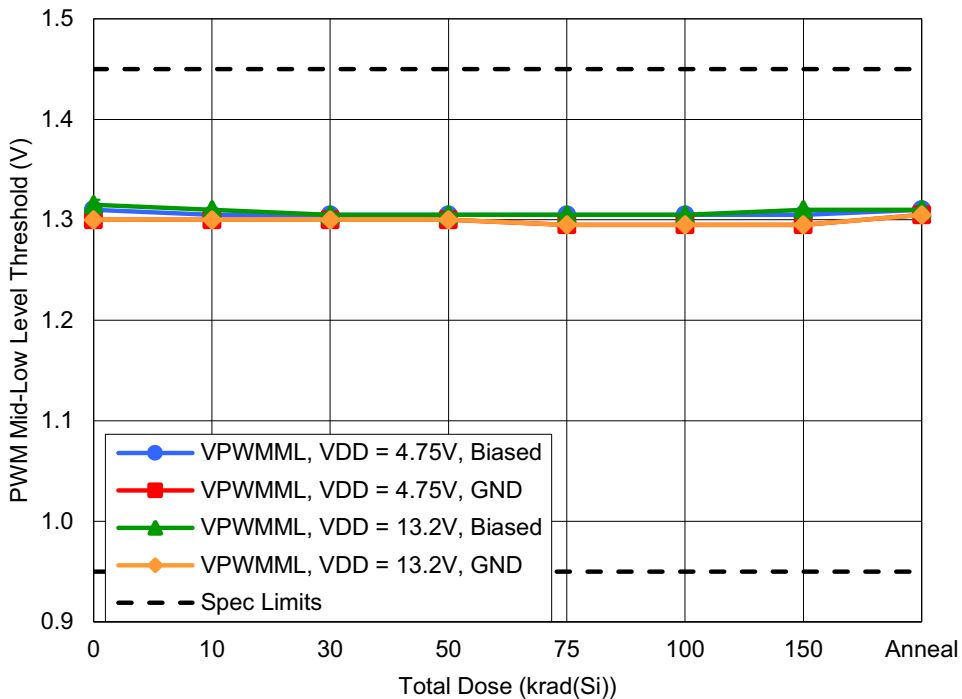

Figure 16. ISL73041SEH low mid-level threshold (V_{PWMLL}) with $V_{DD} = 4.75V$ or $13.2V$ as a function of HDR irradiation and anneal for biased and grounded configurations. The error bars (if visible) represent the minimum and maximum measured values. The datasheet limits are a minimum of $0.95V$ and a maximum of $1.45V$.

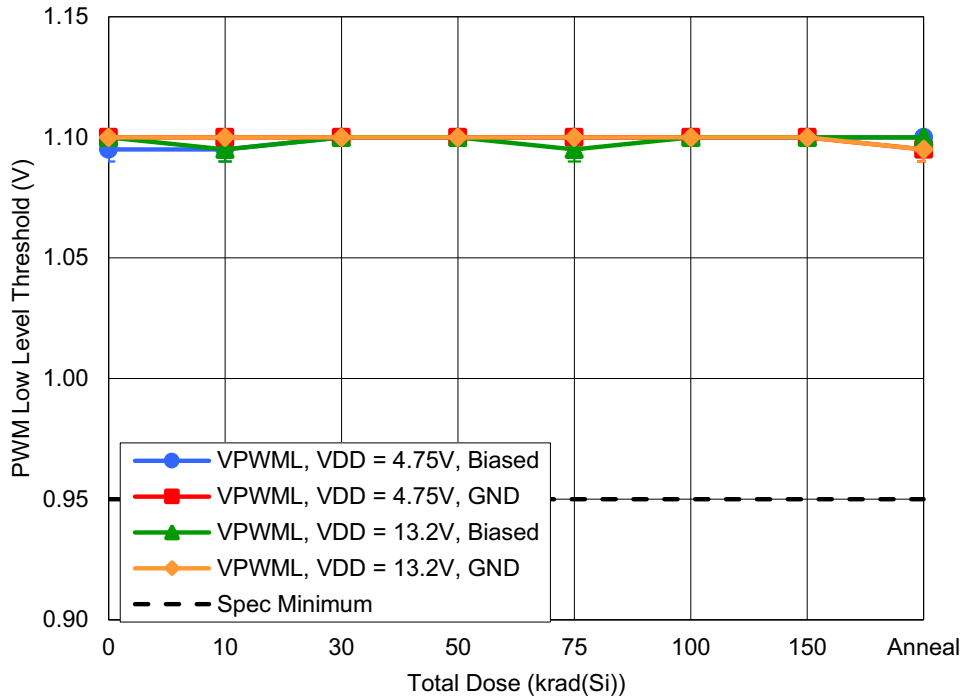

Figure 17. ISL73041SEH PWM low level threshold (V_{PWML}) with $V_{DD} = 4.75V$ or $13.2V$ as a function of HDR irradiation and anneal for biased and grounded configurations. The error bars (if visible) represent the minimum and maximum measured values. The datasheet limit is a minimum of $0.95V$.

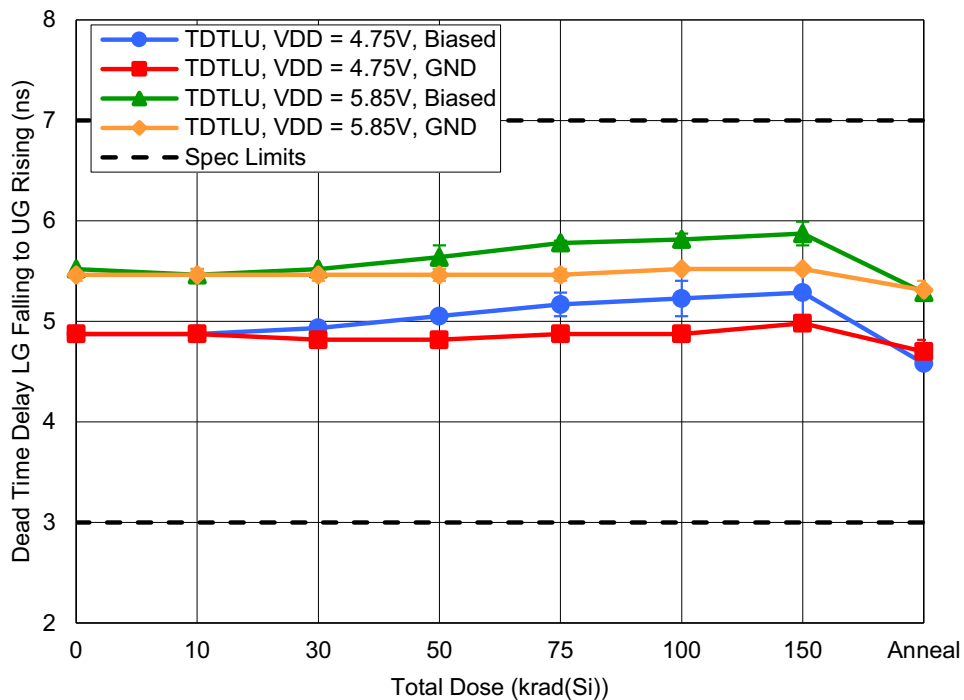

Figure 18. ISL73041SEH dead time delay, LG falling to UG rising (t_{DTLU}) with $V_{DD} = 4.75V$ or $5.85V$, and with $R_{DU} = R_{DL} = 1k\Omega$ to GND as a function of HDR irradiation and anneal for biased and grounded configurations. The error bars (if visible) represent the minimum and maximum measured values. The datasheet limits are a minimum of $3ns$ and a maximum of $7ns$.

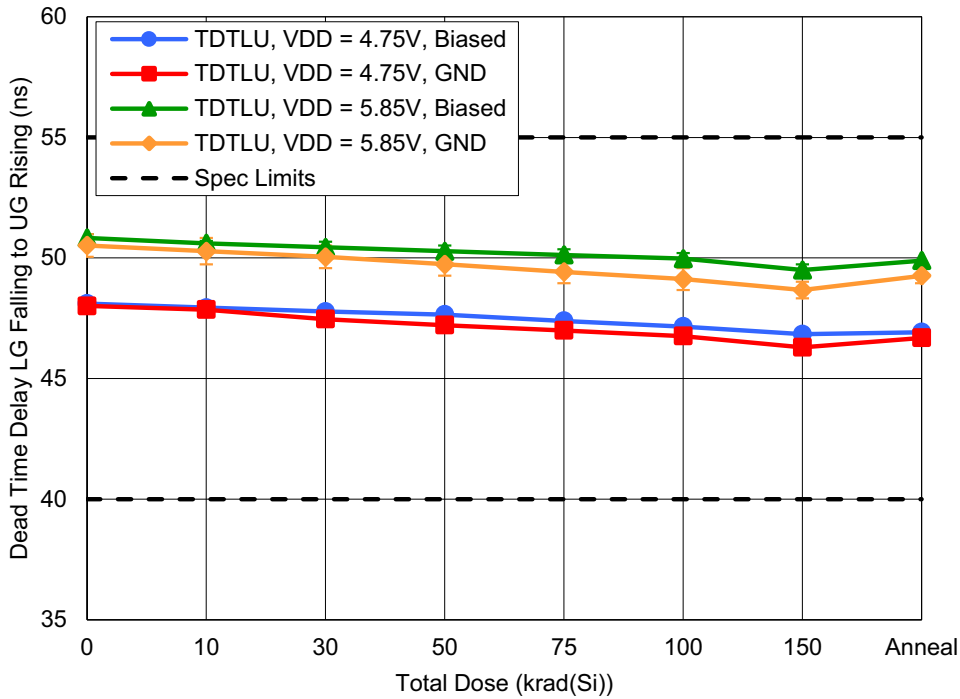

Figure 19. ISL73041SEH dead time delay, LG falling to UG rising ($t_{D\text{TLU}}$) with $V_{DD} = 4.75\text{V}$ or 5.85V , and with $R_{DU} = R_{DL} = 10\text{k}\Omega$ to GND as a function of HDR irradiation and anneal for biased and grounded configurations. The error bars (if visible) represent the minimum and maximum measured values. The datasheet limits are a minimum of 40ns and a maximum of 55ns.

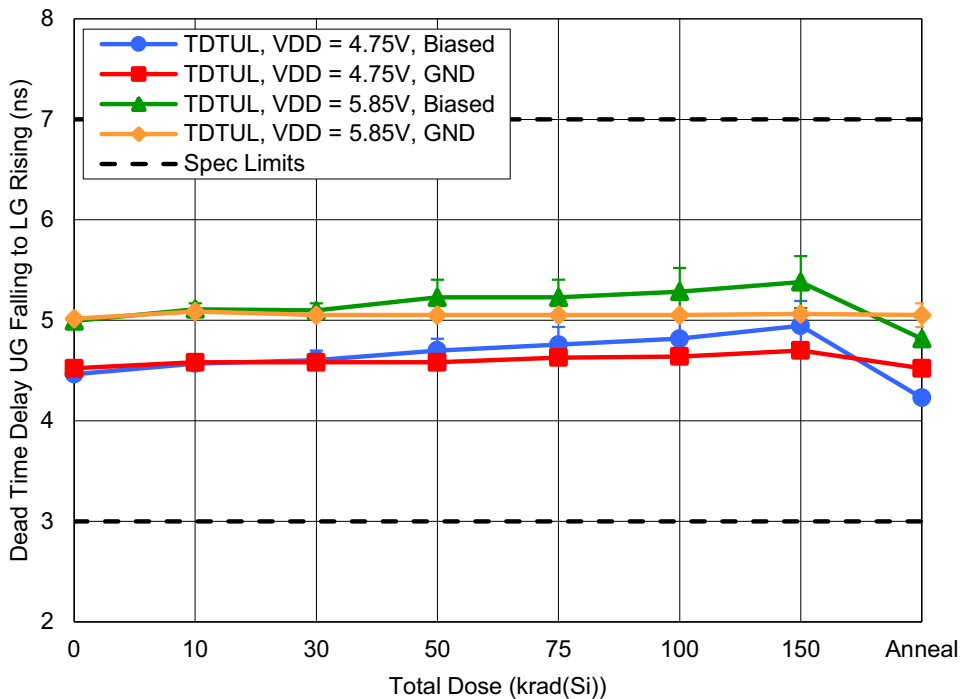

Figure 20. ISL73041SEH dead time delay, UG falling to LG rising ($t_{D\text{TUL}}$) with $V_{DD} = 4.75\text{V}$ or 5.85V , and with $R_{DU} = R_{DL} = 1\text{k}\Omega$ to GND as a function of HDR irradiation and anneal for biased and grounded configurations. The error bars (if visible) represent the minimum and maximum measured values. The datasheet limits are a minimum of 3ns and a maximum of 7ns.

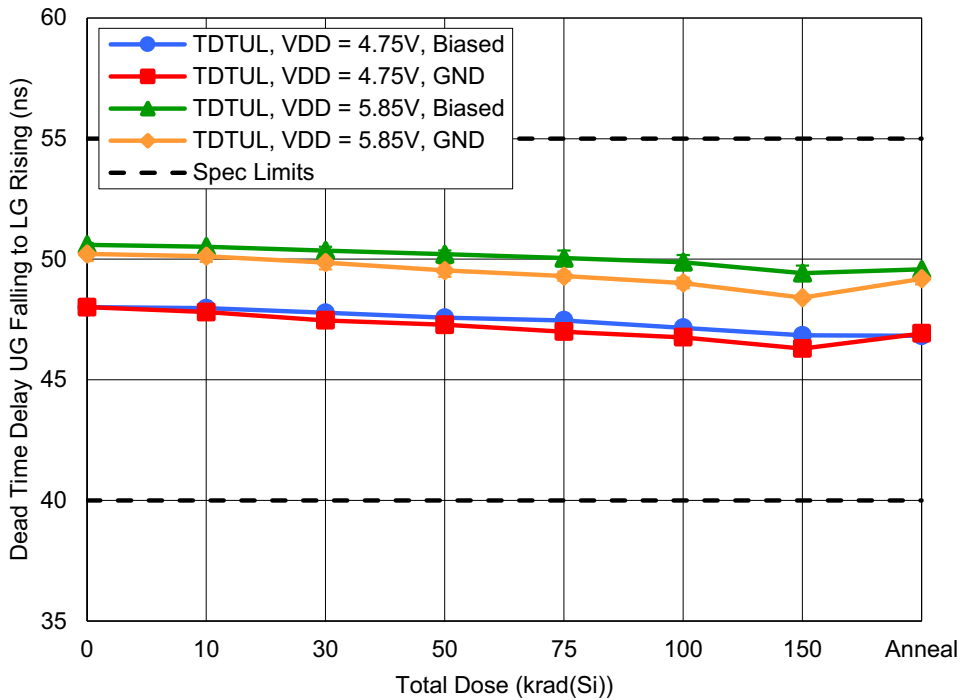

Figure 21. ISL73041SEH dead time delay, UG falling to LG rising (t_{DTUL}) with $V_{DD} = 4.75V$ or $5.85V$, and with $RDU = RDL = 10k\Omega$ to GND as a function of HDR irradiation and anneal for biased and grounded configurations. The error bars (if visible) represent the minimum and maximum measured values. The datasheet limits are a minimum of 40ns and a maximum of 55ns.

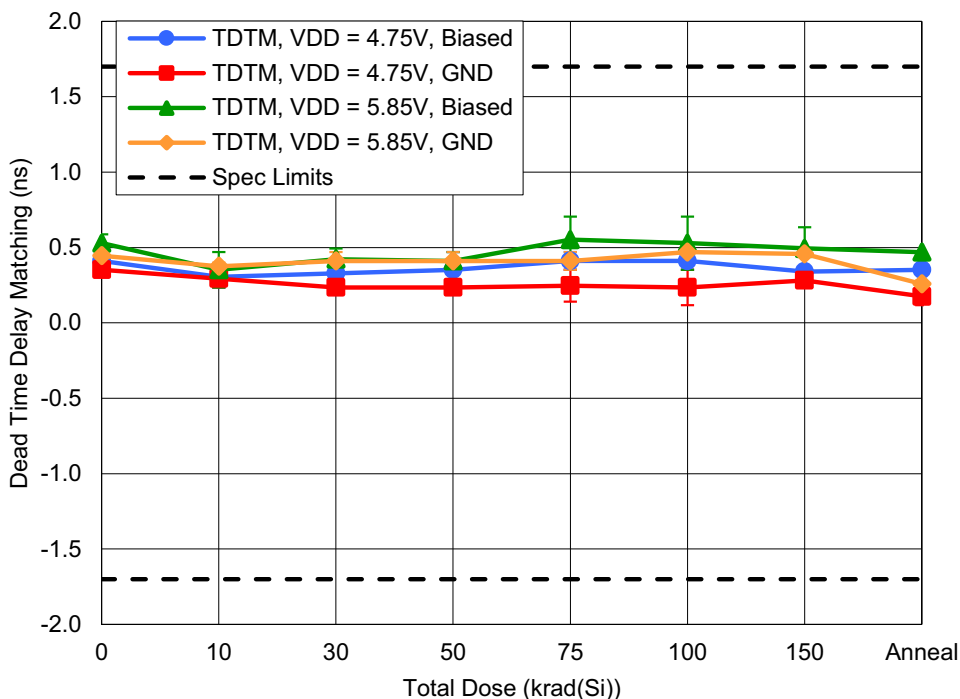

Figure 22. ISL73041SEH dead time delay matching (t_{DTM}) with $V_{DD} = 4.75V$ or $5.85V$, and with $RDU = RDL = 1k\Omega$ to GND as a function of HDR irradiation and anneal for biased and grounded configurations. The error bars (if visible) represent the minimum and maximum measured values. The datasheet limits are a minimum of -1.7ns and a maximum of 1.7ns.

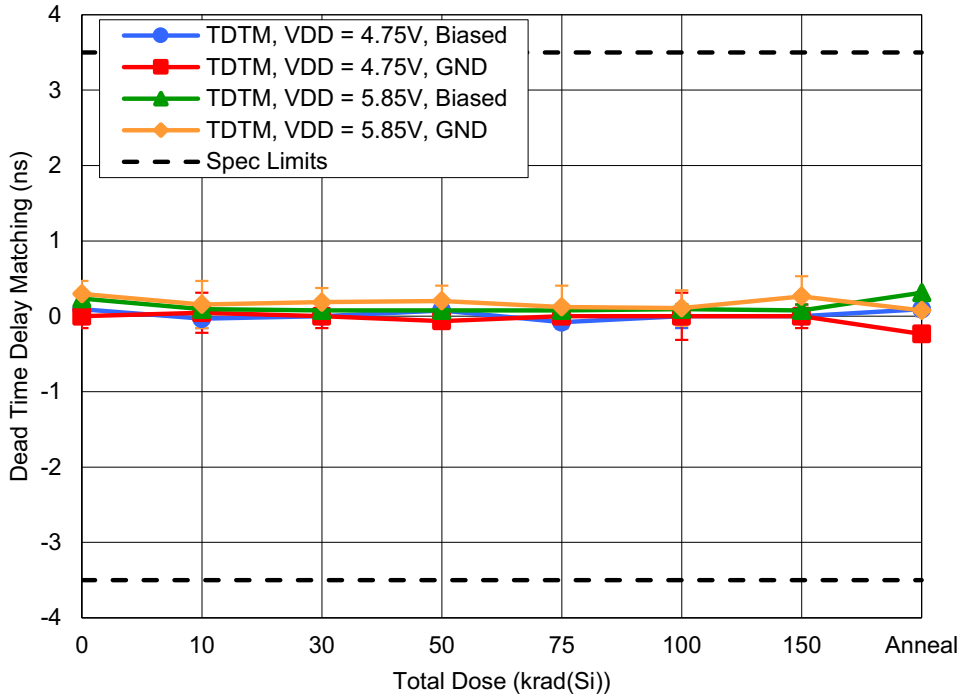

Figure 23. ISL73041SEH dead time delay matching (t_{DTM}) with $V_{DD} = 4.75V$ or $5.85V$, and $R_{DU} = R_{DL} = 10k\Omega$ to GND as a function of HDR irradiation and anneal for biased and grounded configurations. The error bars (if visible) represent the minimum and maximum measured values. The datasheet limits are a minimum of $-3.5ns$ and a maximum of $3.5ns$.

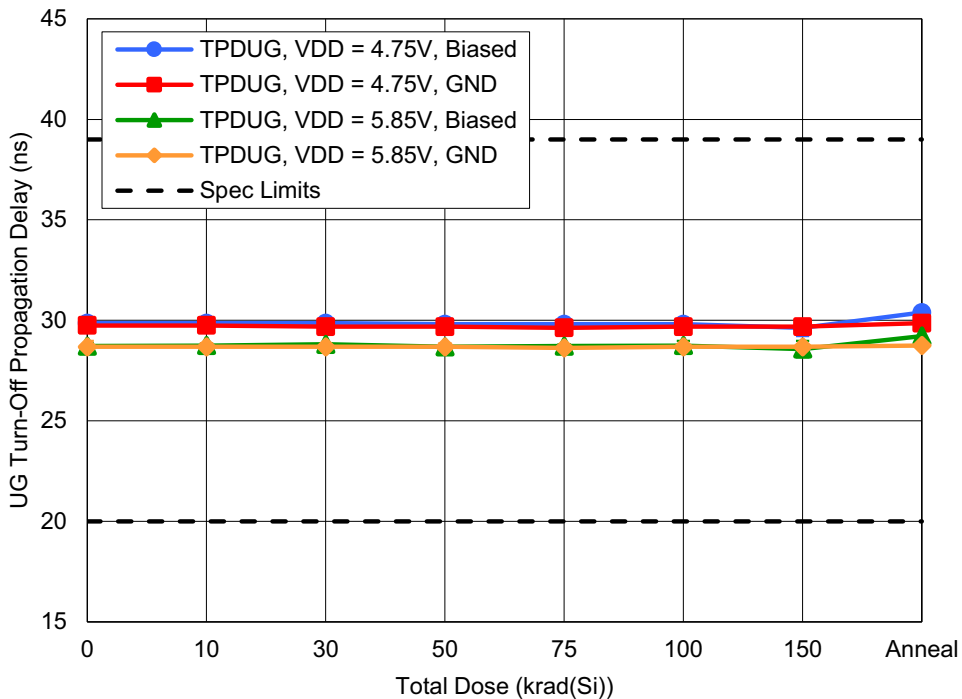

Figure 24. ISL73041SEH UG turn-off propagation delay, PWM falling to UG falling, (t_{PDUG}) with $V_{DD} = 4.75V$ or $5.85V$, and with $PVCC = BOOT-PHS = 4.5V$ as a function of HDR irradiation and anneal for biased and grounded configurations. The error bars (if visible) represent the minimum and maximum measured values. The datasheet limits are a minimum of $20ns$ and a maximum of $39ns$.

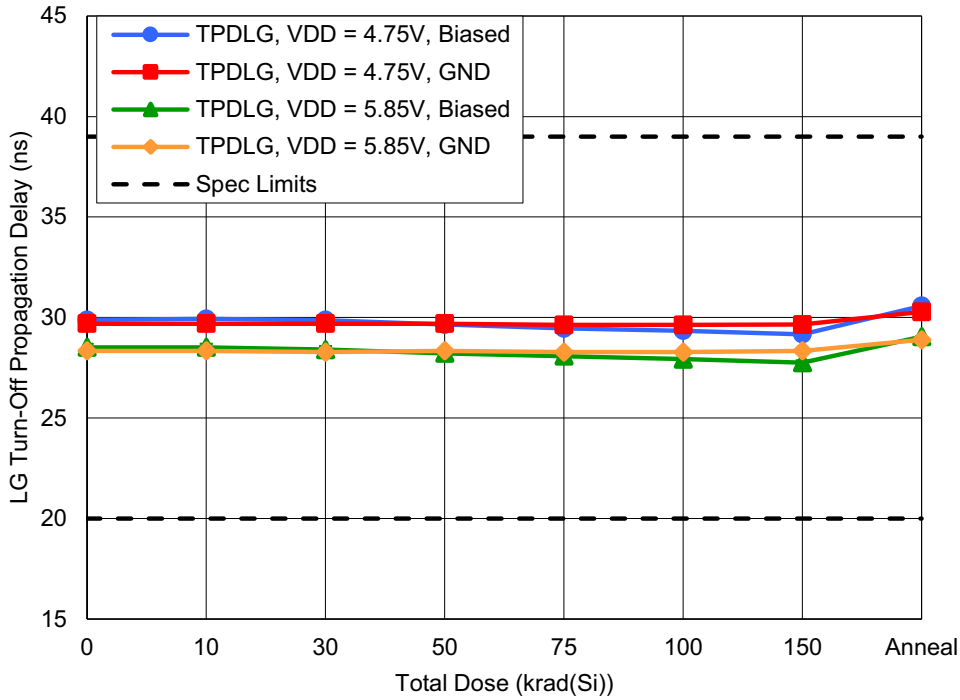

Figure 25. ISL73041SEH LG turn-off propagation delay, PWM rising to LG falling, (t_{PDLG}) with $V_{DD} = 4.75V$ or $5.85V$, and with $PVCC = BOOT-PHS = 4.5V$ as a function of HDR irradiation and anneal for biased and grounded configurations. The error bars (if visible) represent the minimum and maximum measured values. The datasheet limits are a minimum of 20ns and a maximum of 39ns.

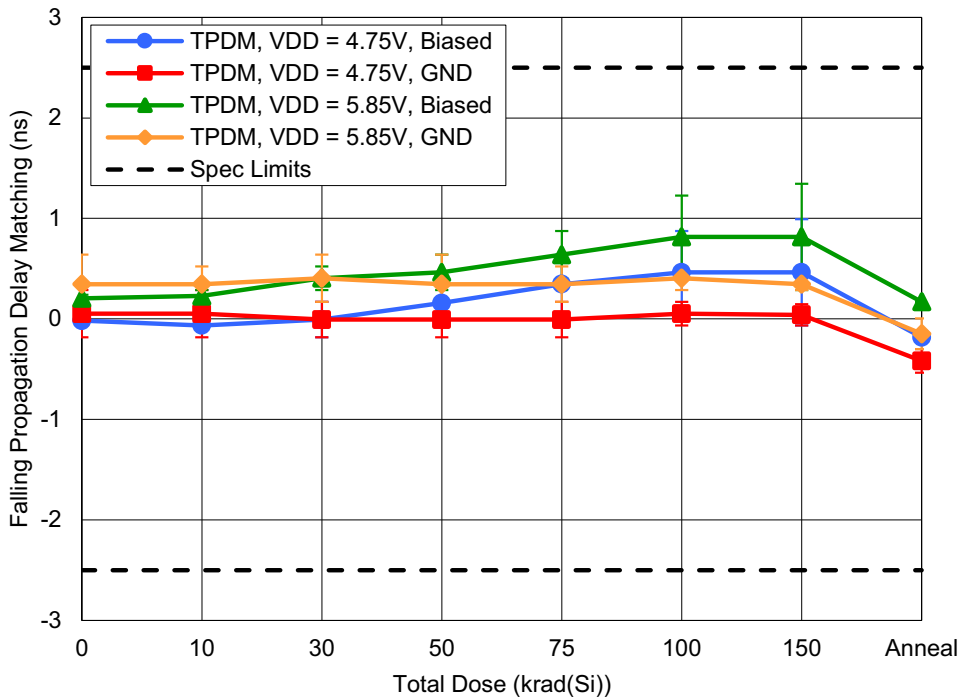

Figure 26. ISL73041SEH propagation delay matching (t_{PDM}) with $V_{DD} = 4.75V$ or $5.85V$, and with $PVCC = BOOT-PHS = 4.5V$ as a function of HDR irradiation and anneal for biased and grounded configurations. The error bars (if visible) represent the minimum and maximum measured values. The datasheet limits are a minimum of -2.5ns and a maximum of 2.5ns.

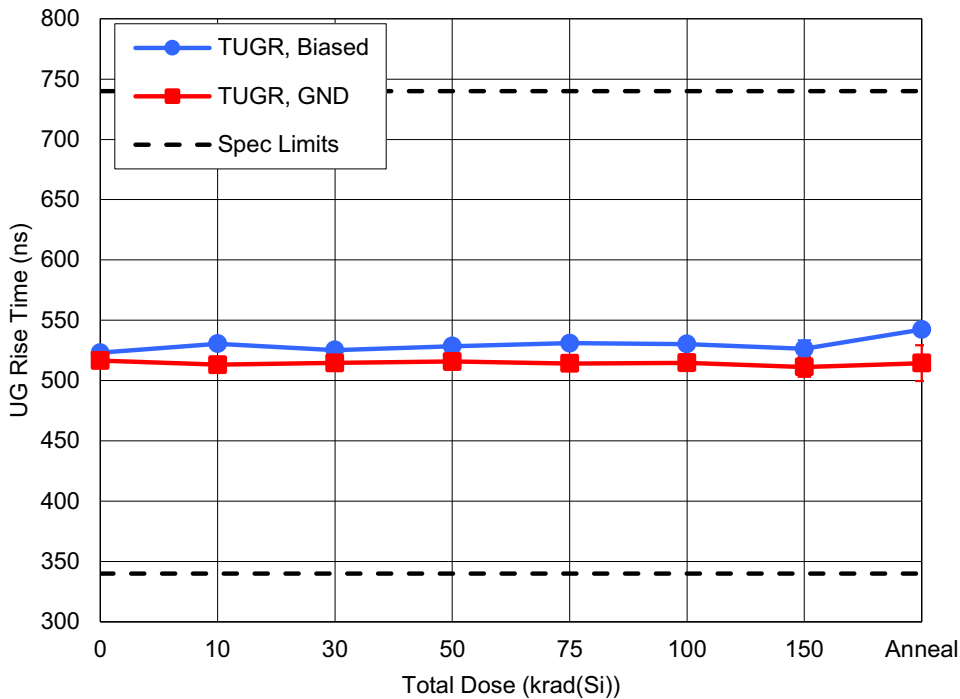

Figure 27. ISL73041SEH UG 30% to 70% rise time (t_{UGR}) with $V_{DD} = 4.75V$, $PVCC = BOOT-PHS = 4.5V$ and with UG $C_{LOAD} = 470nF$ as a function of HDR irradiation and anneal for biased and grounded configurations. The error bars (if visible) represent the minimum and maximum measured values. The datasheet limits are a minimum of 340ns and a maximum of 740ns.

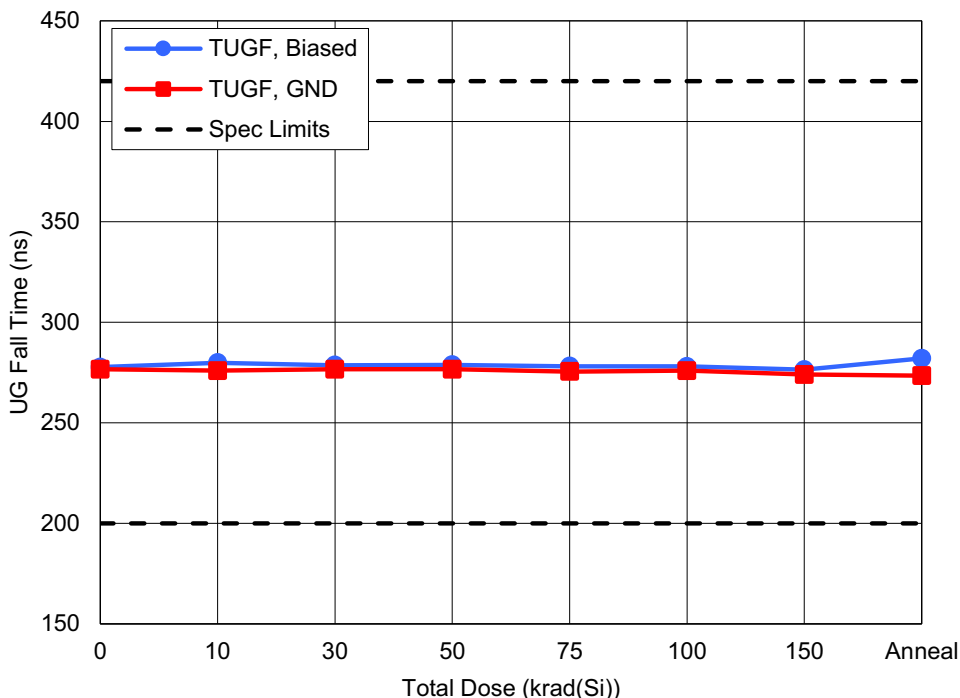

Figure 28. ISL73041SEH UG 70% to 30% fall time (t_{UGF}) with $V_{DD} = 4.75V$, $PVCC = BOOT-PHS = 4.5V$ and with UG $C_{LOAD} = 470nF$ as a function of HDR irradiation and anneal for biased and grounded configurations. The error bars (if visible) represent the minimum and maximum measured values. The datasheet limits are a minimum of 200ns and a maximum of 420ns.

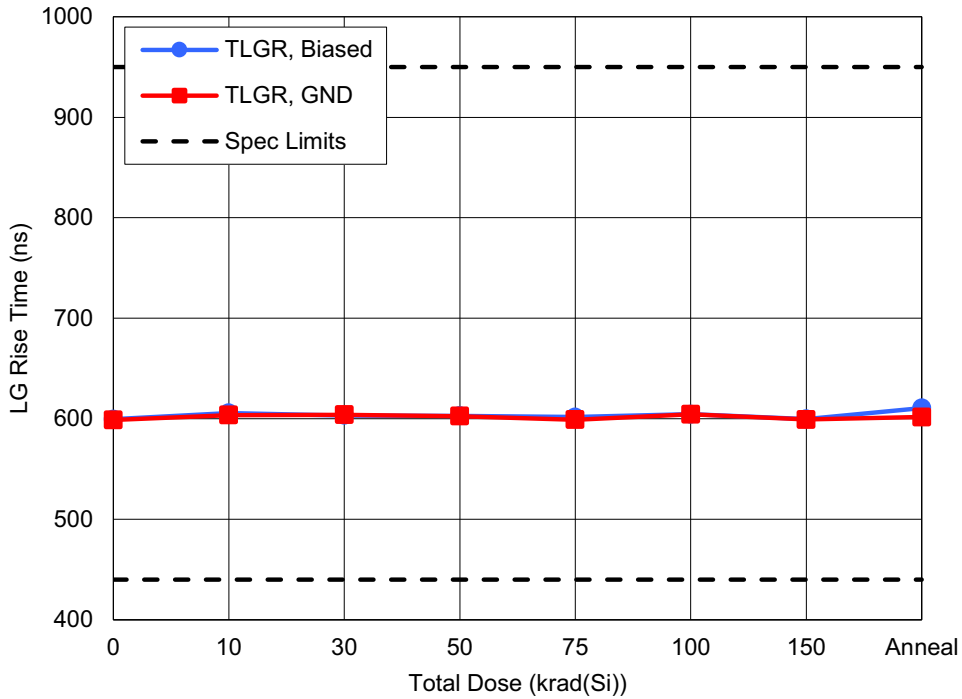

Figure 29. ISL73041SEH LG 30% to 70% rise time (t_{LGR}) with $V_{DD} = 4.75V$, $PVCC = BOOT-PHS = 4.5V$ and with LG $C_{LOAD} = 940ns$ as a function of HDR irradiation and anneal for biased and grounded configurations. The error bars (if visible) represent the minimum and maximum measured values. The datasheet limits are a minimum of 440ns and a maximum of 950ns.

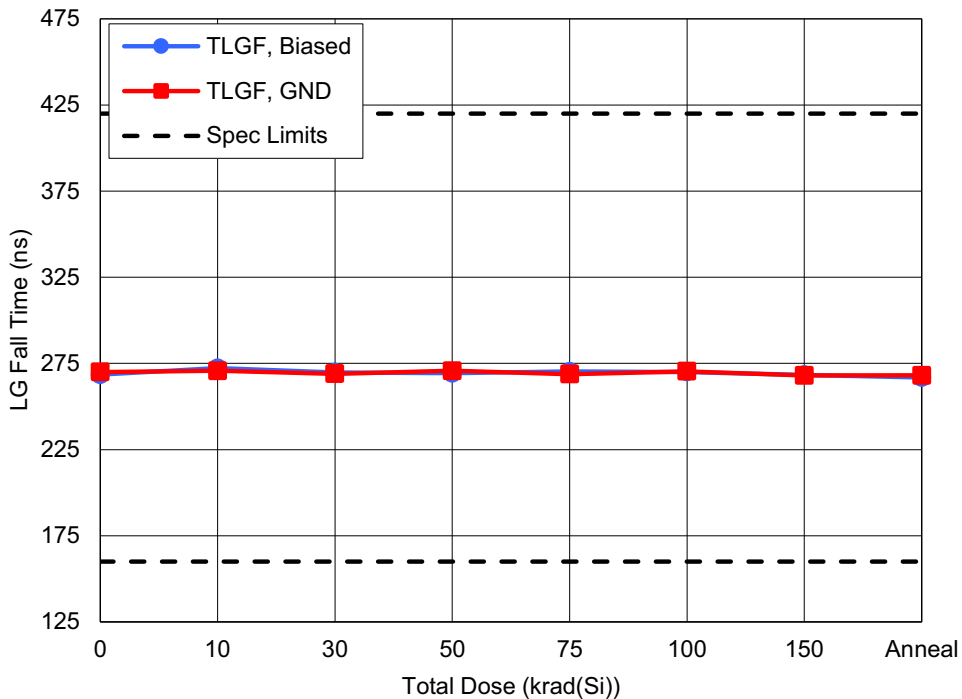

Figure 30. ISL73041SEH LG 70% to 30% fall time (t_{LGF}) with $V_{DD} = 4.75V$, $PVCC = BOOT-PHS = 4.5V$ and with LG $C_{LOAD} = 940nF$ as a function of HDR irradiation and anneal for biased and grounded configurations. The error bars (if visible) represent the minimum and maximum measured values. The datasheet limits are a minimum of 160ns and a maximum of 420ns.

3. Discussion and Conclusion

This document reports the results of the TID test of the ISL73041SEH radiation hardened 12V Half Bridge GaN FET Driver. The irradiation of biased and grounded samples to 150krad(Si) at HDR of 73rad(Si)/s was followed by a 168-hour anneal at 100°C under bias. The data for samples irradiated at HDR are provided for guidance only as the ISL73041SEH is only acceptance tested to 75krad(Si) at LDR. All datasheet parameters passed at all downpoints. No evidence of bias dependence was observed.

4. Revision History

Revision	Date	Description
1.00	Dec 13, 2023	Initial release.

A. Appendix

A.1 Reported Parameters

Table 3 lists the datasheet parameters that are considered indicative of part performance. These parameters are plotted in Figure 3 through Figure 30. All limits are taken from the ISL73041SEH datasheet, which may also have more details on test conditions.

Table 3. ISL73041SEH Datasheet Total Dose Parameters (TA = 25°C)

Fig.	Parameter	Symbol	Test Conditions	Lower Limit	Upper Limit	Unit
3	Quiescent Supply Current	I_{DDQ}	$V_{DD} = 13.2V$; EN = V_{DD} ; PWM = Float; RDU = RDL = 1kΩ to GND	-	13	mA
4			$V_{DD} = 13.2V$; EN = V_{DD} ; PWM = Float; RDU = RDL = 10kΩ to GND		6	
5	Boot Quiescent Current	I_{Q_BOOT}	$V_{DD} = 13.2V$; EN = V_{DD} ; PWM = Float; BOOT-PHS = 4.5V	-	650	μA
6	PVCC Feedback Voltage	V_{FB}	$V_{DD} = 13.2V$	1.188	1.212	V
7	PVCC Gate Drive Voltage	PVCC	$V_{DD} = 4.85V$ or 13.2V; FB = PVCC; $I_{OUT} = 150mA$	4.39	4.6	V
8			$V_{DD} = 4.85V$ or 13.2V; FB = 0.266 × PVCC; $I_{OUT} = 150mA$			
9			$V_{DD} = 5.85V$ to 13.2V; FB = 0.218 × PVCC; $I_{OUT} = 150mA$	5.39	5.6	
10	Internal LDO Voltage	AVCC	$V_{DD} = 5.25V$ or 13.2V; $I_{OUT} = 20mA$	4.7	5.4	V
11	PVCC UVLO Rising Threshold	VR_{PVCC}	$V_{DD} = 13.2V$; PVCC = 5.5V with external FB resistors	5.21	5.45	V
12	PVCC UVLO Falling Threshold	VF_{PVCC}	$V_{DD} = 13.2V$; PVCC = 5.5V with external FB resistors	5.07	5.27	V
13	PVCC UVLO Hysteresis	VH_{PVCC}	$V_{DD} = 13.2V$; $VR_{PVCC} - VF_{PVCC}$	100	300	mV
14	PWM High Level Threshold	V_{PWMH}	$V_{DD} = 4.75V$ or 13.2V	-	2.8	V
15	PWM High Mid-Level Threshold	V_{PWMMH}	$V_{DD} = 4.75V$ or 13.2V	2.4	2.8	V
16	PWM Low Mid-Level Threshold	V_{PWMLL}	$V_{DD} = 4.75V$ or 13.2V	0.95	1.45	V
17	PWM Low Level Threshold	V_{PWML}	$V_{DD} = 4.75V$ or 13.2V	0.95	-	V
18	Dead Time Delay LG falling to UG rising	t_{DTLU}	$V_{DD} = 4.75V$ or 5.85V; PVCC = BOOT - PHS = 4.5V to 5.5V; RDU = RDL = 1kΩ to GND	3	7	ns
19			$V_{DD} = 4.75V$ or 5.85V; PVCC = BOOT-PHS = 4.5V to 5.5V; RDU = RDL = 10kΩ to GND	40	55	

Table 3. ISL73041SEH Datasheet Total Dose Parameters (TA = 25°C)

Fig.	Parameter	Symbol	Test Conditions	Lower Limit	Upper Limit	Unit
20	Dead Time Delay UG falling to LG rising	t_{DTUL}	$V_{DD} = 4.75V$ or $5.85V$; PVCC = BOOT - PHS = 4.5V to 5.5V; RDU = RDL = 1k Ω to GND	3	7	ns
21			$V_{DD} = 4.75V$ or $5.85V$; PVCC = BOOT - PHS = 4.5V to 5.5V; RDU = RDL = 10k Ω to GND	40	55	
22	Dead Time Delay Matching $T_{DTLU} - T_{DTUL}$	t_{DTM}	$V_{DD} = 4.75V$ or $5.85V$; PVCC = BOOT - PHS = 4.5V to 5.5V; RDU = RDL = 1k Ω to GND	-1.7	1.7	ns
23			$V_{DD} = 4.75V$ or $5.85V$; PVCC = BOOT - PHS = 4.5V to 5.5V; RDU = RDL = 10k Ω to GND	-3.5	3.5	
24	UG Turn - Off Propagation Delay PWM Falling to UG Falling	t_{PDUG}	$V_{DD} = 4.75V$ or $5.85V$; PVCC = BOOT - PHS = 4.5V	20	39	ns
25	LG Turn-Off Propagation Delay PWM Rising to LG Falling	t_{PDLG}	$V_{DD} = 4.75V$ or $5.85V$; PVCC = BOOT - PHS = 4.5V	20	39	ns
26	Propagation Delay Matching $t_{PDUG} - t_{PDLG}$	t_{PDM}	$V_{DD} = 4.75V$ or $5.85V$; PVCC = BOOT - PHS = 4.5V	-2.5	2.5	ns
27	UG Rise Time	t_{UGR}	$V_{DD} = 4.75V$; PVCC = BOOT - PHS = 4.5V; UG $C_{LOAD} = 470nF$; 30% to 70%	340	740	ns
28	UG Fall Time	t_{UGF}	$V_{DD} = 4.75V$; PVCC = BOOT - PHS = 4.5V; UG $C_{LOAD} = 470nF$; 70% to 30%	200	420	ns
29	LG Rise Time	t_{LGR}	$V_{DD} = 4.75V$; PVCC = BOOT - PHS = 4.5V; LG $C_{LOAD} = 940nF$; 30% to 70%	440	950	ns
30	LG Fall Time	t_{LGF}	$V_{DD} = 4.75V$; PVCC = BOOT - PHS = 4.5V; LG $C_{LOAD} = 940nF$; 70% to 30%	160	420	ns

A.2 Related Information

For a full list of related documents, visit our website:

- [ISL73041SEH](#) device page
- MIL-STD-883 test method 1019

IMPORTANT NOTICE AND DISCLAIMER

RENESAS ELECTRONICS CORPORATION AND ITS SUBSIDIARIES (“RENESAS”) PROVIDES TECHNICAL SPECIFICATIONS AND RELIABILITY DATA (INCLUDING DATASHEETS), DESIGN RESOURCES (INCLUDING REFERENCE DESIGNS), APPLICATION OR OTHER DESIGN ADVICE, WEB TOOLS, SAFETY INFORMATION, AND OTHER RESOURCES “AS IS” AND WITH ALL FAULTS, AND DISCLAIMS ALL WARRANTIES, EXPRESS OR IMPLIED, INCLUDING, WITHOUT LIMITATION, ANY IMPLIED WARRANTIES OF MERCHANTABILITY, FITNESS FOR A PARTICULAR PURPOSE, OR NON-INFRINGEMENT OF THIRD PARTY INTELLECTUAL PROPERTY RIGHTS.

These resources are intended for developers skilled in the art designing with Renesas products. You are solely responsible for (1) selecting the appropriate products for your application, (2) designing, validating, and testing your application, and (3) ensuring your application meets applicable standards, and any other safety, security, or other requirements. These resources are subject to change without notice. Renesas grants you permission to use these resources only for development of an application that uses Renesas products. Other reproduction or use of these resources is strictly prohibited. No license is granted to any other Renesas intellectual property or to any third party intellectual property. Renesas disclaims responsibility for, and you will fully indemnify Renesas and its representatives against, any claims, damages, costs, losses, or liabilities arising out of your use of these resources. Renesas' products are provided only subject to Renesas' Terms and Conditions of Sale or other applicable terms agreed to in writing. No use of any Renesas resources expands or otherwise alters any applicable warranties or warranty disclaimers for these products.

(Disclaimer Rev.1.0 Mar 2020)

Corporate Headquarters

TOYOSU FORESIA, 3-2-24 Toyosu,
Koto-ku, Tokyo 135-0061, Japan
www.renesas.com

Contact Information

For further information on a product, technology, the most up-to-date version of a document, or your nearest sales office, please visit:
www.renesas.com/contact/

Trademarks

Renesas and the Renesas logo are trademarks of Renesas Electronics Corporation. All trademarks and registered trademarks are the property of their respective owners.