

Introduction

This report provides results of a total ionizing dose (TID) test of the [ISL72026SEH](#), [ISL72027SEH](#) and [ISL72028SEH](#) Controller Area Network (CAN) transceivers. The test was conducted in order to determine the sensitivity of the parts to the total dose environment. Irradiations were performed to 75krad(Si) at 0.01rad(Si)/s under biased and grounded conditions and were followed by a biased anneal at +100 °C for 168 hours. No rejects to the SMD parametric limits were encountered.

Reference Documents

- MIL-STD-883 test method 1019
- [ISL72026SEH](#) datasheet
- [ISL72027SEH](#) datasheet
- [ISL72028SEH](#) datasheet
- DLA Land and Maritime Standard Microcircuit Drawing (SMD) [5962-15228](#)

Part Description

The Intersil ISL7202xSEH product family consists of the ISL72026SEH, ISL72027SEH and ISL72028SEH, which differ in functionality as outlined in the following. These parts are 3.3V radiation tolerant Controller Area Network (CAN) transceivers that are compatible with the ISO11898-2 standard. Applications include serial communication in satellites and aerospace communications and telemetry data processing in harsh industrial environments. The transceiver can transmit and receive at bus speeds of up to 1Mbps. The devices are designed to operate over a common-mode range of -7V to +12V with a maximum of 120 nodes. The device has three discrete selectable driver rise/fall time options, a listen mode feature and a split termination output. The Receiver (RX) inputs feature a “full fail-safe” design, which ensures a logic high receiver output if the RX inputs are floating, shorted, or terminated but not driven. The ISL72027SEH is available in an 8 Ld hermetic ceramic flatpack and die form and operates over the -55 °C to +125 °C temperature range. The logic inputs are compatible with 5V systems as well as with 3.3V systems. The three parts use the same die and the specific functionality is selected by wire bonding diagram.

The use of redundant bus transceivers is common in high reliability systems. In this arrangement, both active and quiescent devices can be present simultaneously on the bus with the quiescent devices powered down as cold spares. To support cold sparing, the powered-down ISL7202xSEH transceiver ($V_{CC} < 200mV$) has a resistance between the VREF pin or the CANH pin or CANL pin and the VCC supply rail of >480kΩ (max) with a typical resistance of >2MΩ. The resistance between CANH and CANL of a powered down transceiver has a typical resistance of 80kΩ.

The individual part descriptions are as follows:

1. ISL72026SEH: CAN transceiver, 1Mbps, listen mode, loopback
2. ISL72027SEH: CAN transceiver, 1Mbps, listen mode, split termination output
3. ISL72028SEH: CAN transceiver, 1Mbps, low power shutdown, split termination output

The reader is referred to the relevant Intersil datasheet and other on-line information for further detail on the CAN protocol. [Figures 1, 2](#) and [3](#) supply functional diagrams for all three variants, while [Table 1](#) shows their pin assignments.

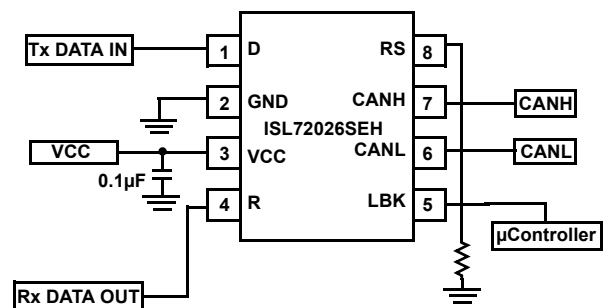

FIGURE 1. ISL72026SEH FUNCTIONAL DIAGRAM

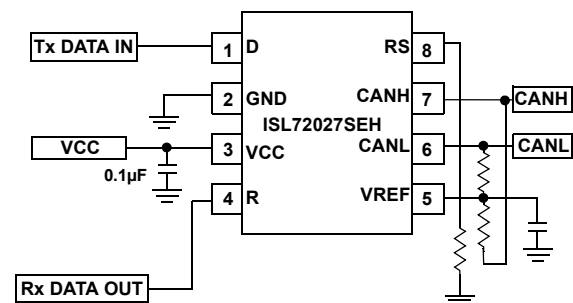

FIGURE 2. ISL72027SEH FUNCTIONAL DIAGRAM

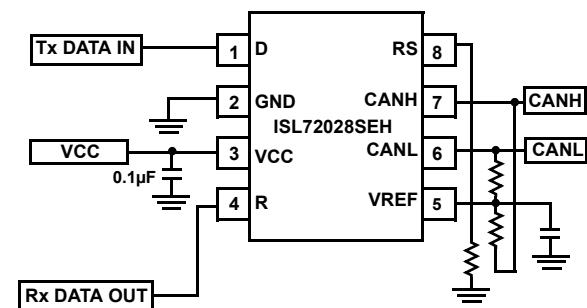

FIGURE 3. ISL72028SEH FUNCTIONAL DIAGRAM

TABLE 1. ISL72026SEH, ISL72027SEH AND ISL72028SEH PINOUTS

PIN NUMBER	ISL72026SEH	ISL72027SEH	ISL72028SEH
	PIN NAME		
1	D	D	D
2	GND	GND	GND
3	VCC	VCC	VCC
4	R	R	R
5	LBK	VREF	VREF
6	CANL	CANL	CANL
7	CANH	CANH	CANH
8	RS	RS	RS
Package lid	Tied internally to pin 2 (GND)	Tied internally to pin 2 (GND)	Tied internally to pin 2 (GND)

Test Description

Irradiation Facilities

Irradiations were performed using a Hopewell Designs N40 panoramic low dose rate ⁶⁰Co irradiator located in the Palm Bay, Florida Intersil facility. The dose rate was 0.0089rad(Si)/s (8.9mrad(Si)/s), in accordance with MIL-STD-883 Method 1019. The irradiations used a PbAl spectrum hardening filter to shield the test board and devices under test against low energy secondary gamma radiation.

Test Fixturing

Figure 4 shows the configuration and power supply sequencing used for biased irradiation.

ISL72026SEH, ISL72027SEH, ISL72028SHE and ISL7202xSEH Radiation Schematic

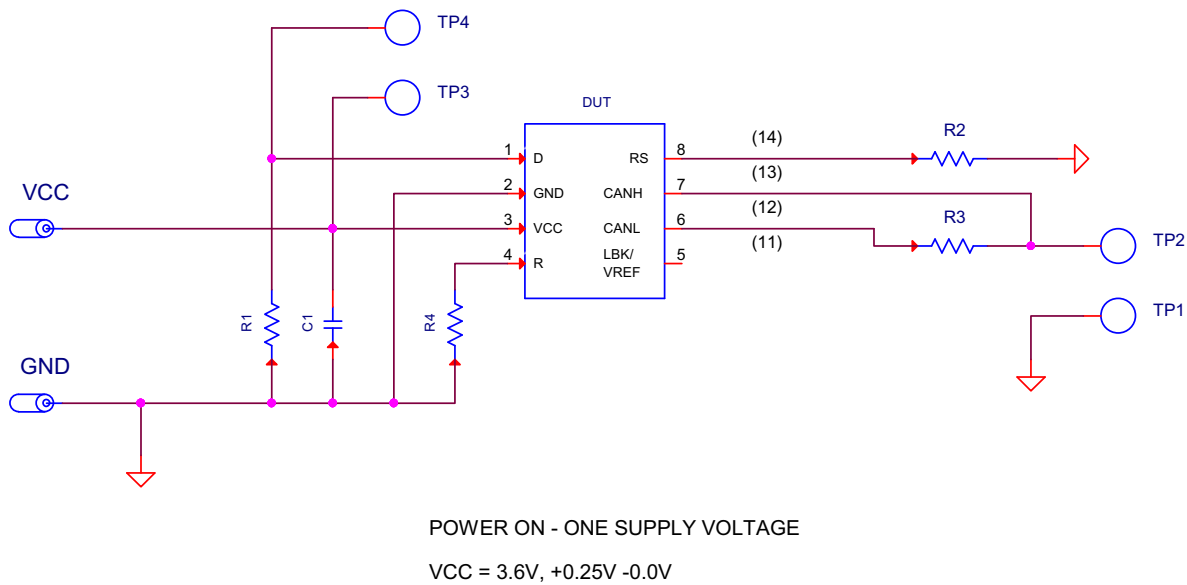

FIGURE 4. IRRADIATION BIAS CONFIGURATION AND POWER SUPPLY SEQUENCING FOR THE ISL7202xSEH

Characterization Equipment and Procedures

All electrical testing was performed outside the irradiator using production Automated Test Equipment (ATE) with datalogging of all parameters at each downpoint. All downpoint electrical testing was performed at room temperature.

Experimental Matrix

Testing proceeded in accordance with the guidelines of MIL-STD-883 Test Method 1019. The experimental matrix consisted of twelve samples irradiated under bias and twelve samples irradiated with all pins grounded for each of the three part types. Three control units were used.

Samples of the ISL72026SEH, ISL72027SEH and ISL72028SEH were drawn from development lot J676671.1, wafer 02C1 and were packaged in the production hermetic 8-pin ceramic flatpack, package code KCR. The samples were processed through the standard burn-in cycle and were screened to SMD [5962-15228](#) limits at room, low and high temperatures before irradiation.

Downpoints

Downpoints were zero, 10 krad(Si), 30 krad(Si), 50 krad(Si) and 75 krad(Si). The samples were subjected to a high temperature biased anneal for 168 hours at +100 °C following irradiation.

Results

Attributes Data

Testing at low dose rate of the ISL72026SEH, ISL72027SEH and ISL72028SEH is complete and showed no reject devices after irradiation or anneal. [Table 2](#) summarizes the results.

TABLE 2. ISL72026SEH, ISL72027SEH AND ISL72028SEH LOW DOSE RATE TOTAL DOSE TEST ATTRIBUTES DATA

PART	RATE	BIAS	SAMPLE SIZE	DOWNPOINT	BIN 1 (Note 1)	REJECTS
ISL72026SEH	0.0089rad(Si)/s	Figure 4	12	Pre-irradiation	12	
				10krad(Si)	12	0
				30krad(Si)	12	0
				50krad(Si)	12	0
				75krad(Si)	12	0
				Anneal, 168 hours at +100 °C	12	0
ISL72026SEH	0.0089rad(Si)/s	Grounded	12	Pre-irradiation	12	
				10krad(Si)	12	0
				30krad(Si)	12	0
				50krad(Si)	12	0
				75krad(Si)	12	0
				Anneal, 168 hours at +100 °C	12	0
ISL72027SEH	0.0089rad(Si)/s	Figure 4	12	Pre-irradiation	12	
				10krad(Si)	12	0
				30krad(Si)	12	0
				50krad(Si)	12	0
				75 krad(Si)	12	0
				Anneal, 168 hours at +100 °C	12	0
ISL72027SEH	0.0089rad(Si)/s	Grounded	12	Pre-irradiation	12	
				10krad(Si)	12	0
				30krad(Si)	12	0
				50krad(Si)	12	0
				75krad(Si)	12	0
				Anneal, 168 hours at +100 °C	12	0

TABLE 2. ISL72026SEH, ISL72027SEH AND ISL72028SEH LOW DOSE RATE TOTAL DOSE TEST ATTRIBUTES DATA

PART	RATE	BIAS	SAMPLE SIZE	DOWNPOINT	BIN 1 (Note 1)	REJECTS
ISL72028SEH	0.0089rad(Si)/s	Figure 4	12	Pre-irradiation	12	
				10krad(Si)	12	0
				30krad(Si)	12	0
				50krad(Si)	12	0
				75krad(Si)	10 (Note 2)	0
				Anneal, 168 hours at +100°C	10 (Note 2)	0
ISL72028SEH	0.0089rad(Si)/s	Grounded	12	Pre-irradiation	12	
				10krad(Si)	12	0
				30krad(Si)	12	0
				50krad(Si)	12	0
				75krad(Si)	10 (Note 2)	0
				Anneal, 168 hours at +100°C	10 (Note 2)	0

NOTES:

- Bin 1 indicates a device that passes all pre-irradiation specification limits.
- Two samples were removed from the ISL72028SEH biased and grounded populations due to fixture capacity constraints, reducing the sample sizes to 10 each for the 75krad(Si) and anneal downpoints.

Variables Data

The plots in [Figures 5](#) through [43](#) show data at all downpoints. The plots show the average of key parameters as a function of total dose for each of the two irradiation conditions. Most of the plots show a number of parameters on the same set of axes in an attempt to manage the length of this report. All data shown was taken at a supply voltage of 3.0V; the 3.6V supply data showed similar stability and is not plotted. The figure sequence and the symbols of the reported parameters are consistent with those used in the SMD. All parameters showed excellent stability over irradiation. [See “Conclusion” on page 25.](#) for further discussion.

Note also that nearly all of the figures show the TID response of several variants, which generally led to busy plots. Most of the figures report data for all three variants on the same set of axes; the eight figures reporting one or two variants are listed in the following for reference.

[Figure 15:](#) ISL72026SEH and ISL72027SEH, input threshold voltage in listen mode.

[Figure 16:](#) ISL72026SEH and ISL72027SEH, input hysteresis voltage in listen mode.

[Figure 24:](#) ISL72026SEH and ISL72027SEH, supply current in listen mode.

[Figure 25:](#) ISL72028SEH, supply current in low power shutdown mode.

[Figure 30:](#) ISL72027SEH and ISL72028SEH, VREF cold sparing leakage current.

[Figure 40:](#) ISL72026SEH, loopback delay, input to receiver output.

[Figure 41:](#) ISL72027SEH and ISL72028SEH, VREF pin voltage, 5µA sourcing and sinking.

[Figure 42:](#) ISL72027SEH and ISL72028SEH, VREF pin voltage, 50µA sourcing and sinking.

Variables Data Plots

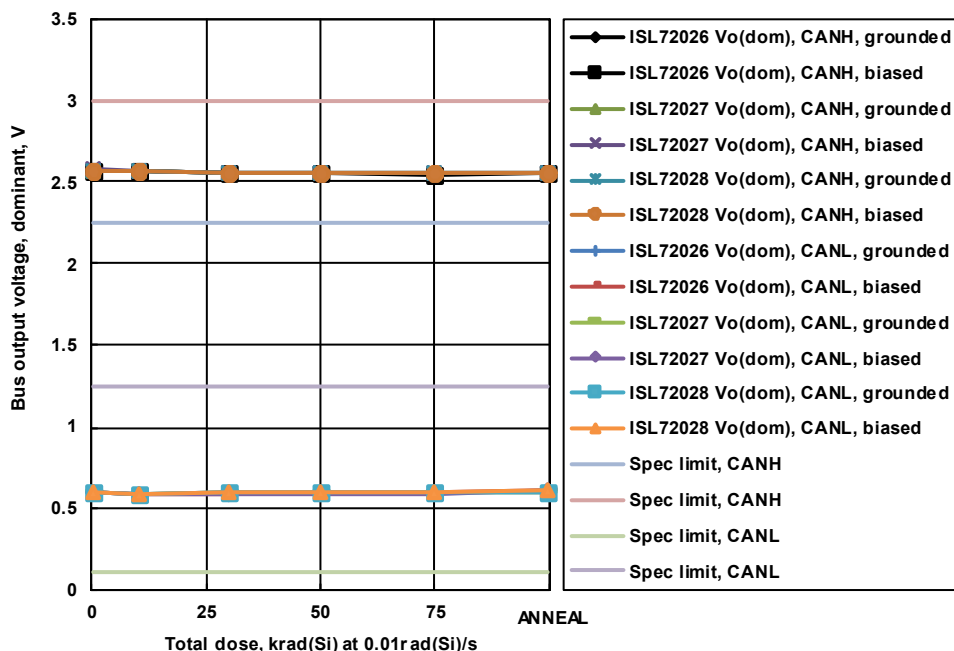

FIGURE 5. ISL72026SEH, ISL72027SEH and ISL72028SEH transmitter dominant bus output voltage ($V_{O(DOM)}$) for 3.0V supply, D = 0V, RS = 0V and CAN HIGH and LOW as a function of low dose rate irradiation for the biased (per [Figure 4](#)) and unbiased (all pins grounded) cases. The dose rate was 0.0089rad(Si)/s and the sample size for each of the six cells was 12. The post-irradiation SMD limits are 2.25V to 3.0V (CAN High) and 0.1V to 1.25V (CAN Low).

Variables Data Plots (Continued)

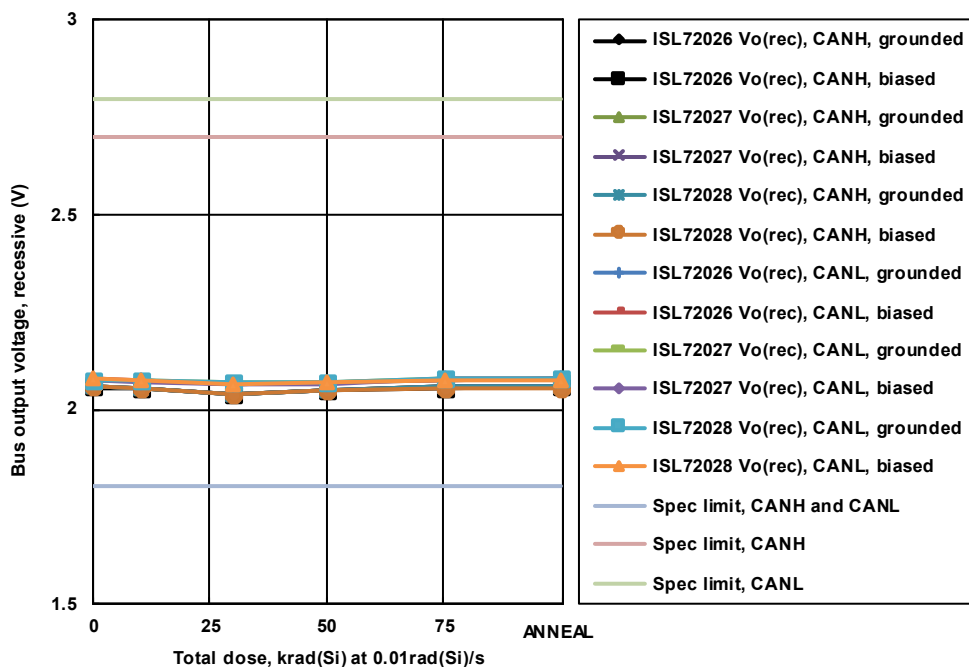

FIGURE 6. ISL72026SEH, ISL72027SEH and ISL72028SEH transmitter recessive bus output voltage ($V_{O(REC)}$) for 3.0V supply, $D = 3.0V$, $R_S = 0V$ and CAN HIGH and LOW as a function of low dose rate irradiation for the biased (per Figure 4) and unbiased (all pins grounded) cases. The dose rate was 0.0089rad(Si)/s and the sample size for each of the six cells was 12. The post-irradiation SMD limits are 1.8V to 2.7V (CAN High and CAN Low).

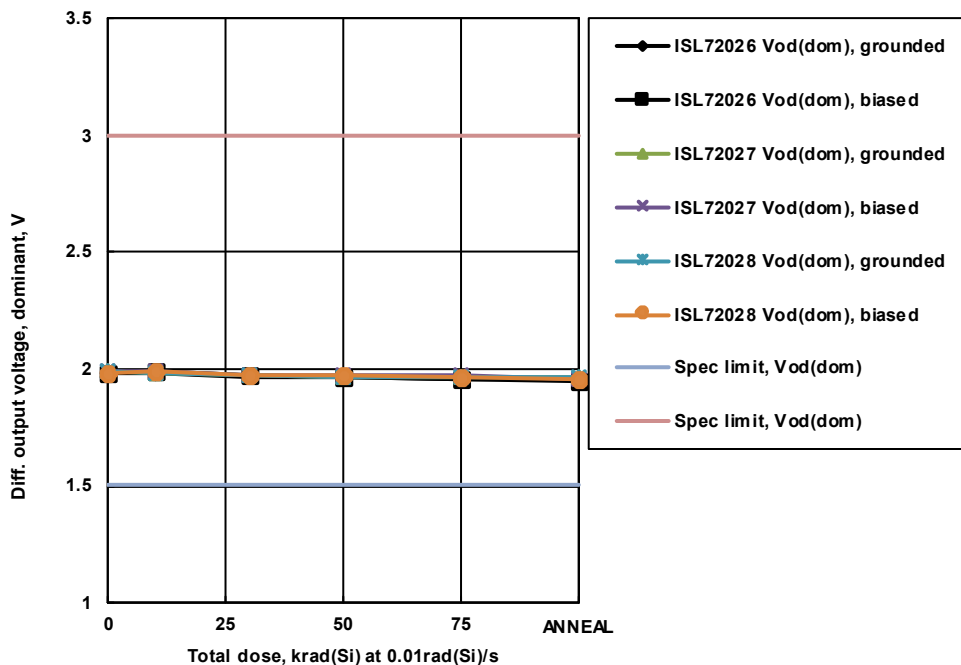

FIGURE 7. ISL72026SEH, ISL72027SEH and ISL72028SEH transmitter dominant output differential voltage ($V_{OD(DOM)}$) for 3.0V supply, $D = 0V$ and $R_S = 0V$ as a function of low dose rate irradiation for the biased (per Figure 4) and unbiased (all pins grounded) cases. The dose rate was 0.0089 rad(Si)/s, and the sample size for each of the six cells was 12. The post-irradiation SMD limits are 1.5V to 3.0V.

Variables Data Plots (Continued)

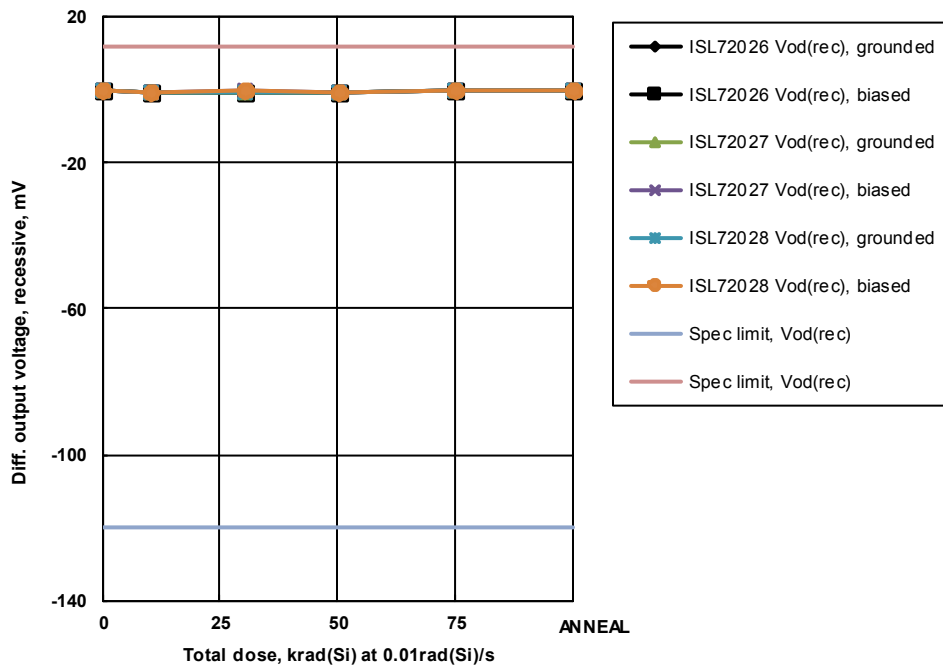

FIGURE 8. ISL72026SEH, ISL72027SEH and ISL72028SEH transmitter recessive output differential voltage ($V_{OD(REC)}$) for 3.0V supply, $D = 0V$ and $R_S = 0V$ as a function of low dose rate irradiation for the biased (per Figure 4) and unbiased (all pins grounded) cases. The dose rate was 0.0089rad(Si)/s, and the sample size for each of the six cells was 12. The post-irradiation SMD limits are -120.0mV to 12.0mV.

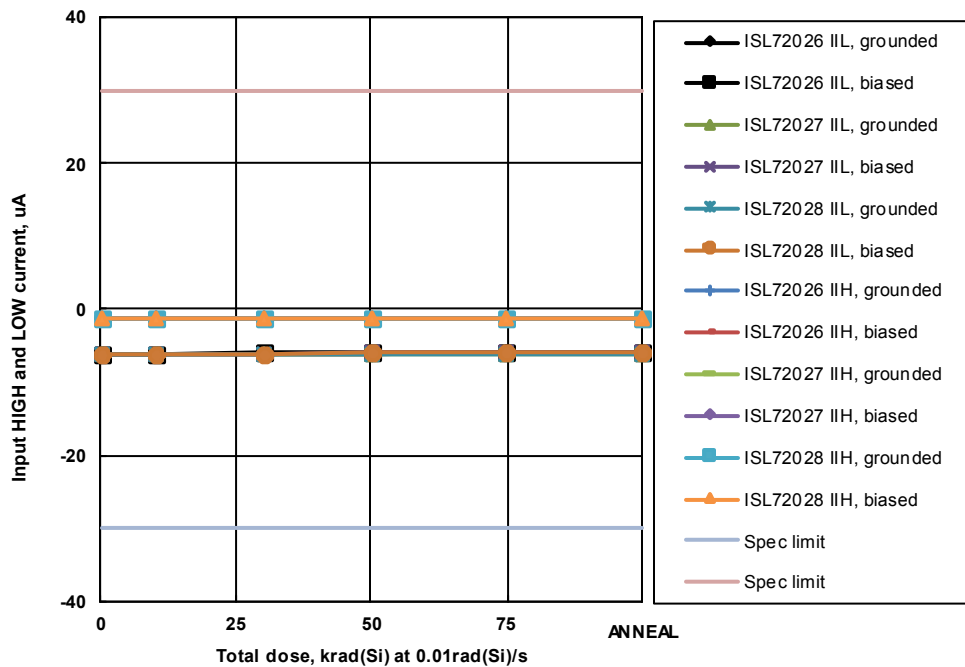

FIGURE 9. ISL72026SEH, ISL72027SEH and ISL72028SEH transmitter D input HIGH ($2.0V_{IN}$) and LOW ($0.8V_{IN}$) input current (I_{IH} and I_{IL}) as a function of low dose rate irradiation for the biased (per Figure 4) and unbiased (all pins grounded) cases. The dose rate was 0.0089rad(Si)/s, and the sample size for each of the six cells was 12. The post-irradiation SMD limits are -30.0uA to 30.0uA.

Variables Data Plots (Continued)

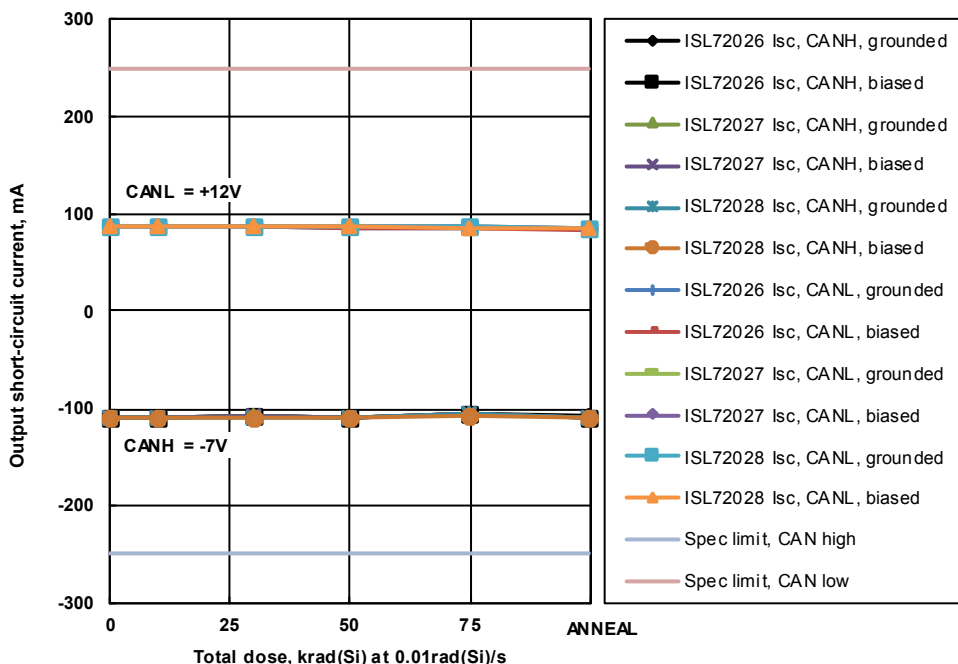

FIGURE 10. ISL72026SEH, ISL72027SEH and ISL72028SEH transmitter output short-circuit current (I_{sc}), $V_{CANH} = -7V$ and V_{CANL} open and $V_{CANL} = 12V$ and V_{CANH} open, as a function of low dose rate irradiation for the biased (per Figure 4) and unbiased (all pins grounded) cases. The dose rate was $0.0089rad(Si)/s$, and the sample size for each of the six cells was 12. The post-irradiation SMD limits are $-250.0mA$ ($V_{CANH} = -7V$) and $+250mA$ ($V_{CANH} = 12V$).

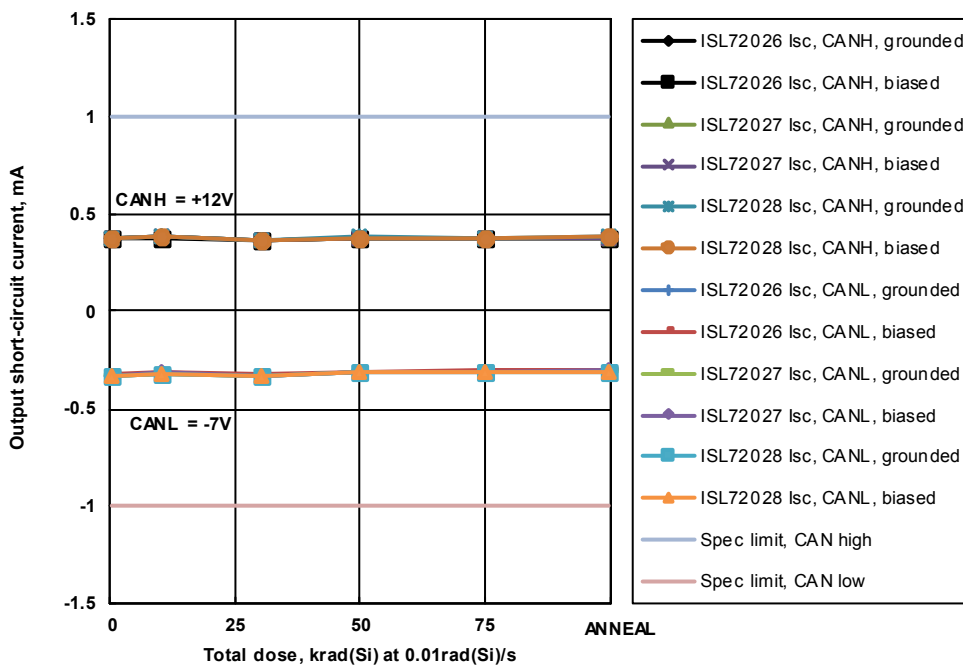

FIGURE 11. ISL72026SEH, ISL72027SEH and ISL72028SEH transmitter output short-circuit current (I_{sc}), $V_{CANH} = 12V$ and V_{CANL} open and $V_{CANL} = -7V$ and V_{CANH} open, as a function of low dose rate irradiation for the biased (per Figure 4) and unbiased (all pins grounded) cases. The dose rate was $0.0089rad(Si)/s$, and the sample size for each of the six cells was 12. The post-irradiation SMD limits are $1.0mA$ ($V_{CANH} = 12V$) and $-1.0mA$ ($V_{CANH} = -7V$).

Variables Data Plots (Continued)

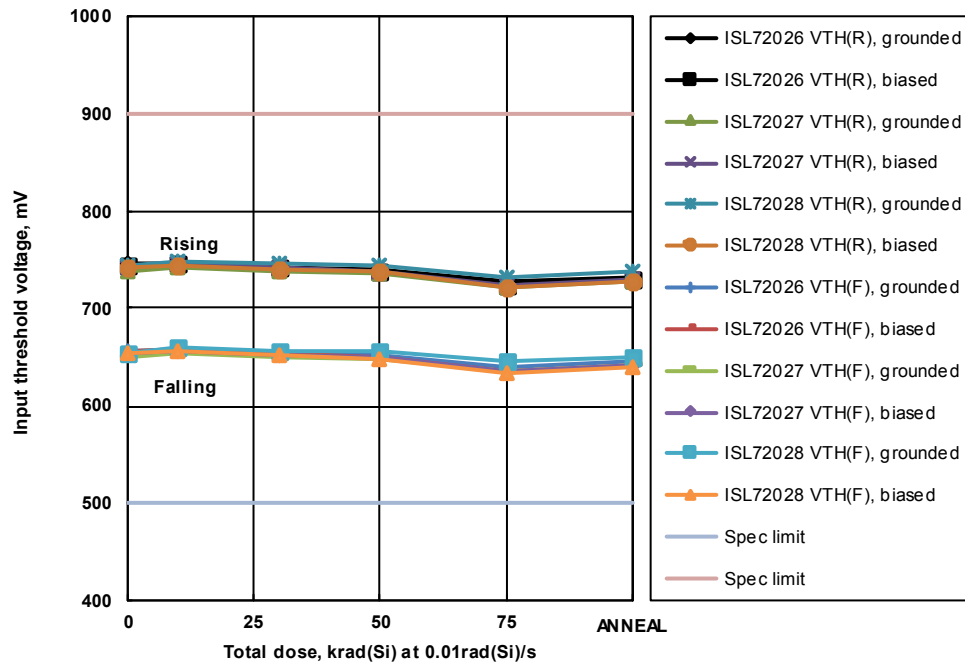

FIGURE 12. ISL72026SEH, ISL72027SEH and ISL72028SEH receiver rising (recessive to dominant) and falling (dominant to recessive) input threshold voltage (V_{THR} and V_{THF}) as a function of low dose rate irradiation for the biased (per Figure 4) and unbiased (all pins grounded) cases. The dose rate was 0.0089rad(Si)/s and the sample size for each of the six cells was 12. The post-irradiation SMD limits are 900mV maximum (rising) and 500mV minimum (falling).

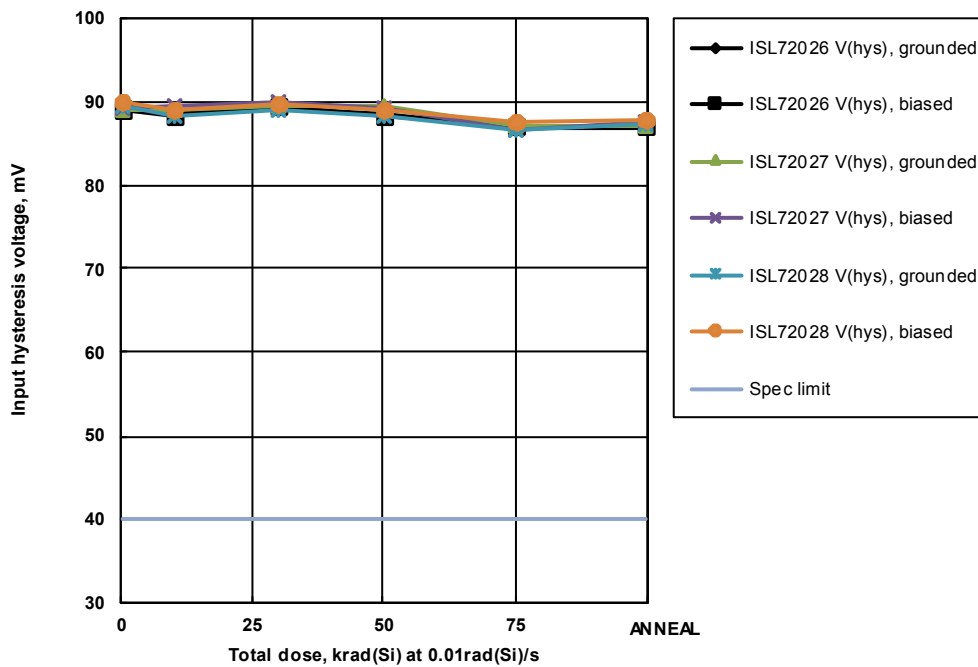

FIGURE 13. ISL72026SEH, ISL72027SEH and ISL72028SEH receiver input hysteresis ($V_{HYS} = V_{THR} - V_{THF}$) as a function of low dose rate irradiation for the biased (per Figure 4) and unbiased (all pins grounded) cases. The dose rate was 0.0089rad(Si)/s and the sample size for each of the six cells was 12. The post-irradiation SMD limit is 40mV minimum.

Variables Data Plots (Continued)

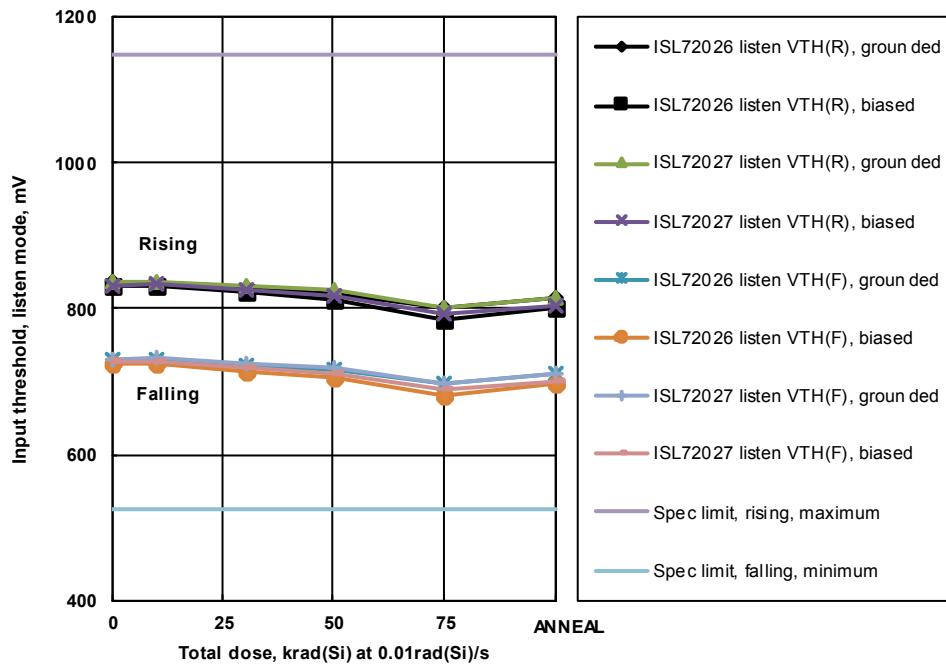

FIGURE 14. ISL72026SEH and ISL72027SEH receiver listen mode rising (recessive to dominant) and falling (dominant to recessive) input threshold voltage (V_{THRLM} and V_{THFLM}) as a function of low dose rate irradiation for the biased (per Figure 4) and unbiased (all pins grounded) cases. The dose rate was 0.0089rad(Si)/s and the sample size for each of the six cells was 12. The post-irradiation SMD limits are 1150mV maximum (rising) and 525mV minimum (falling).

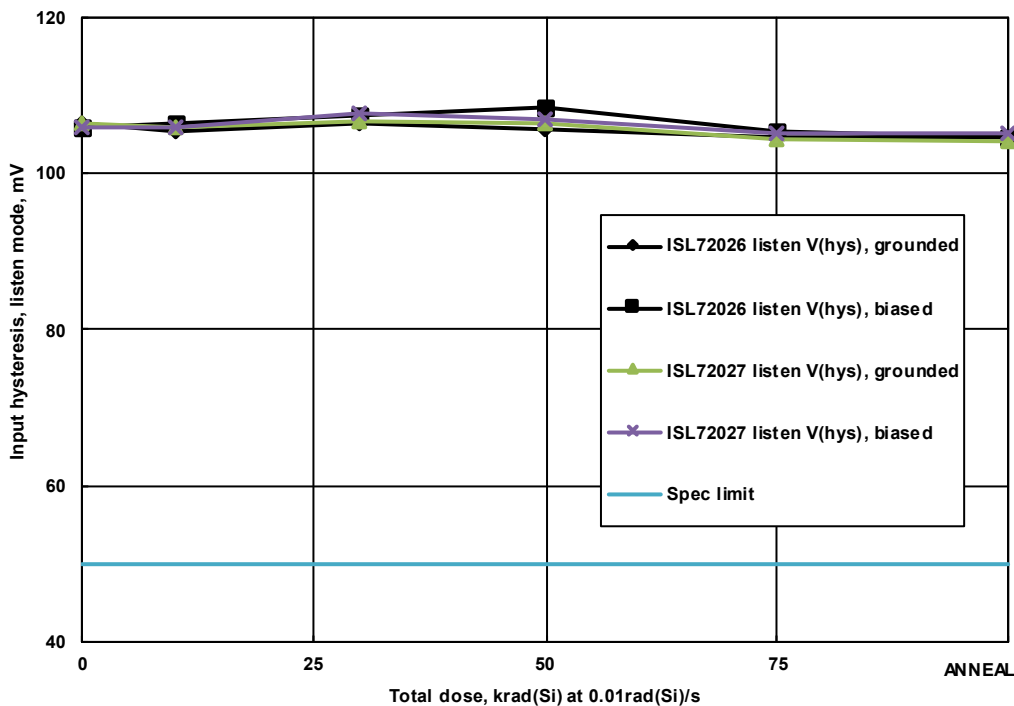

FIGURE 15. ISL72026SEH and ISL72027SEH receiver listen mode input hysteresis ($V_{THRLM} - V_{THFLM}$) as a function of low dose rate irradiation for the biased (per Figure 4) and unbiased (all pins grounded) cases. The dose rate was 0.0089rad(Si)/s, and the sample size for each of the six cells was 12. The post-irradiation SMD limit is 50mV minimum.

Variables Data Plots (Continued)

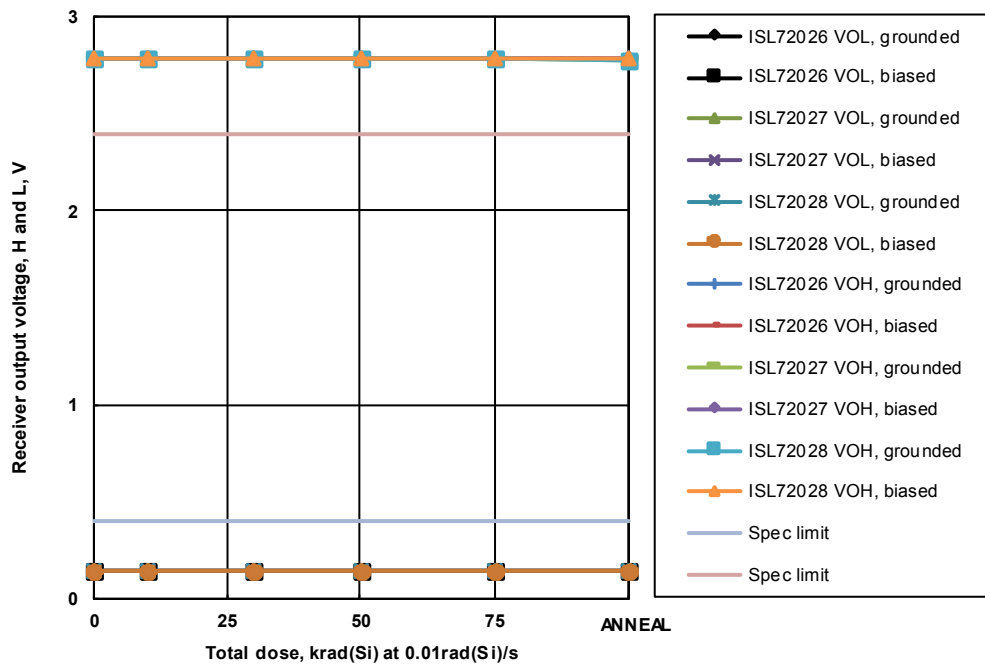

FIGURE 16. ISL72026SEH, ISL72027SEH and ISL72028SEH receiver output High and Low voltage, $I_{OUT} = -4mA (V_{OH})$ and $I_{OUT} = 4mA (V_{OL})$, as a function of low dose rate irradiation for the biased (per Figure 4) and unbiased (all pins grounded) cases. The dose rate was 0.0089rad(Si)/s and the sample size for each of the six cells was 12. The post-irradiation SMD limits are 2.4V minimum (V_{OH}) and 0.4V maximum (V_{OL}).

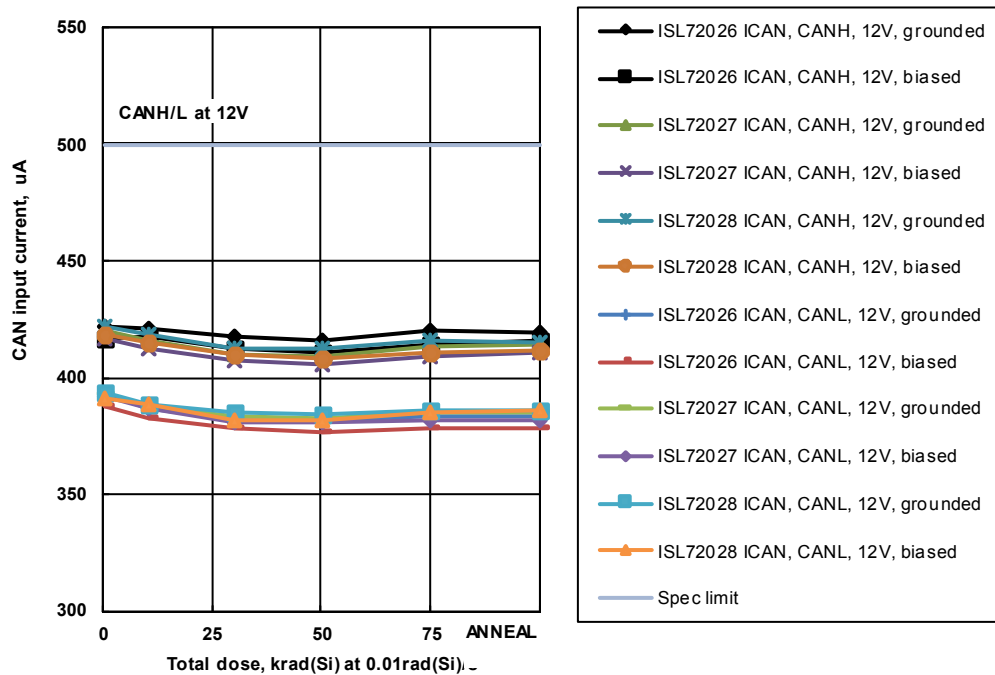

FIGURE 17. ISL72026SEH, ISL72027SEH and ISL72028SEH receiver CAN bus input current (I_{CAN}), CANH or CANL at 12V, $D = 3V$, $LBK = RS = 0V$, as a function of low dose rate irradiation for the biased (per Figure 4) and unbiased (all pins grounded) cases. The dose rate was 0.0089rad(Si)/s and the sample size for each of the six cells was 12. The post-irradiation SMD limit is 500uA maximum.

Variables Data Plots (Continued)

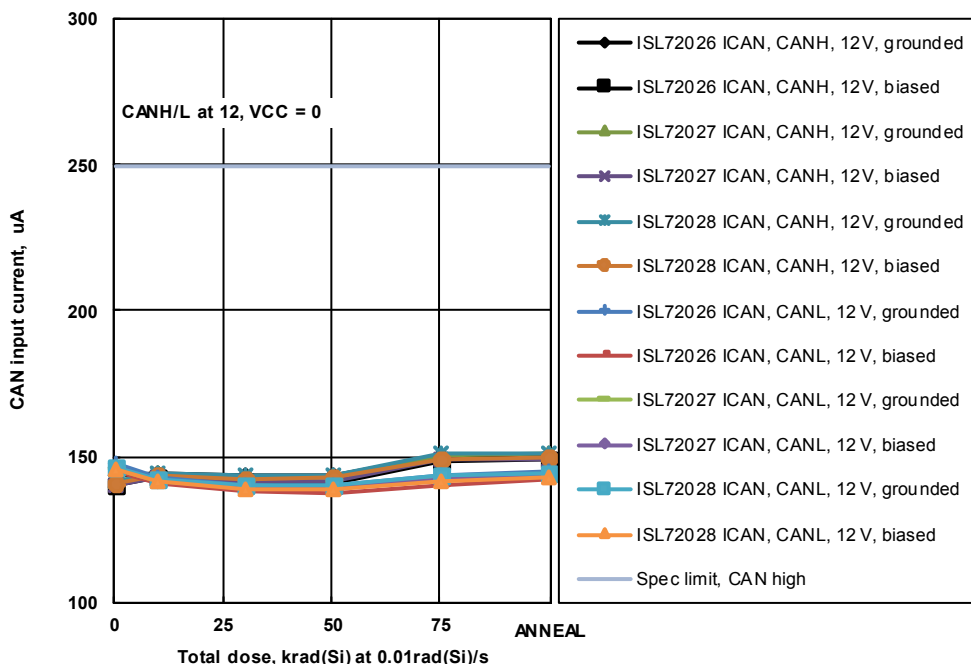

FIGURE 18. ISL72026SEH, ISL72027SEH and ISL72028SEH receiver CAN bus input current (I_{CAN}), CANH or CANL at 12V, D = 3V, V_{CC} = RS = 0V, as a function of low dose rate irradiation for the biased (per Figure 4) and unbiased (all pins grounded) cases. The dose rate was 0.0089rad(Si)/s and the sample size for each of the six cells was 12. The post-irradiation SMD limit is 250µA maximum.

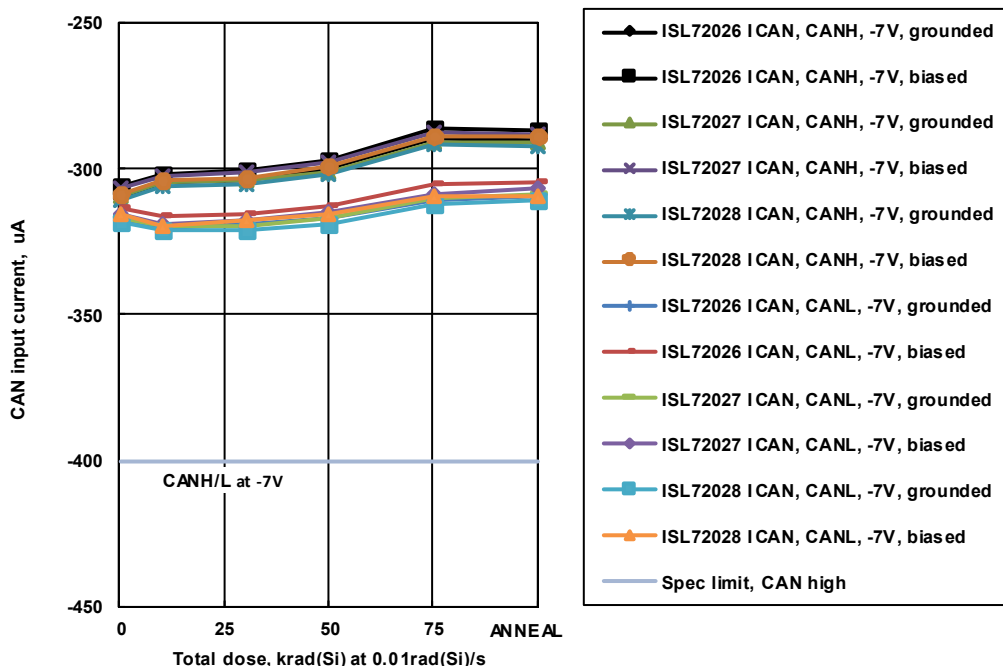

FIGURE 19. ISL72026SEH, ISL72027SEH and ISL72028SEH receiver CAN bus input current (I_{CAN}), CANH or CANL at -7V, D = 3V, LBK = RS = 0V, as a function of low dose rate irradiation for the biased (per Figure 4) and unbiased (all pins grounded) cases. The dose rate was 0.0089rad(Si)/s and the sample size for each of the six cells was 12. The post-irradiation SMD limit is -400µA minimum

Variables Data Plots (Continued)

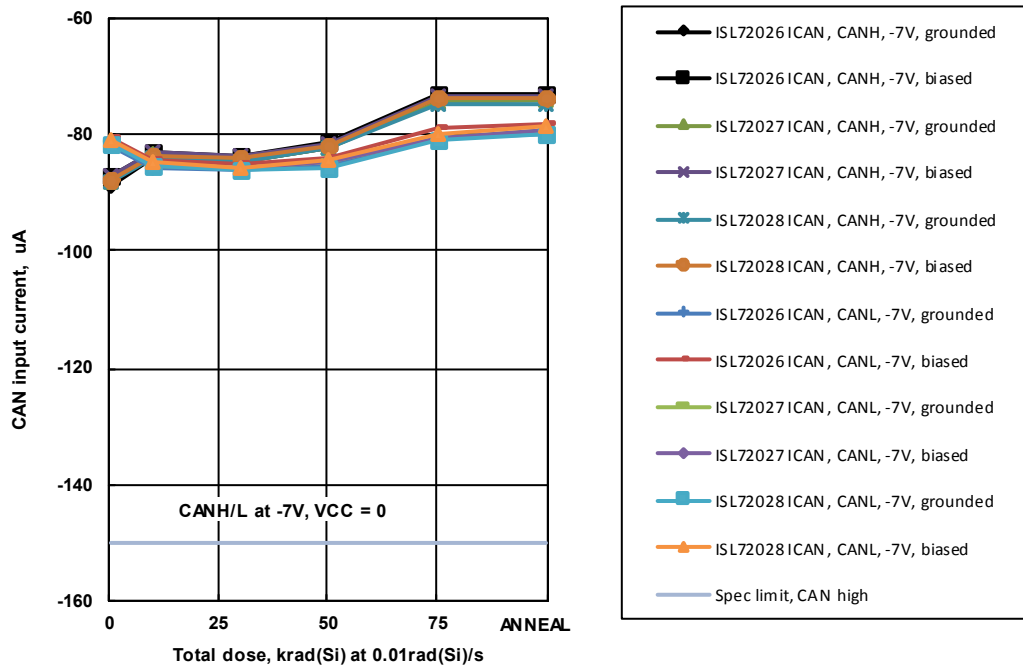

FIGURE 20. ISL72026SEH, ISL72027SEH and ISL72028SEH receiver CAN bus input current (I_{CAN}), CANH or CANL at -7V, $D = 3V$, $V_{CC} = RS = 0V$, as a function of low dose rate irradiation for the biased (per Figure 4) and unbiased (all pins grounded) cases. The dose rate was $0.0089rad(Si)/s$ and the sample size for each of the six cells was 12. The post-irradiation SMD limit is $-150\mu A$ minimum.

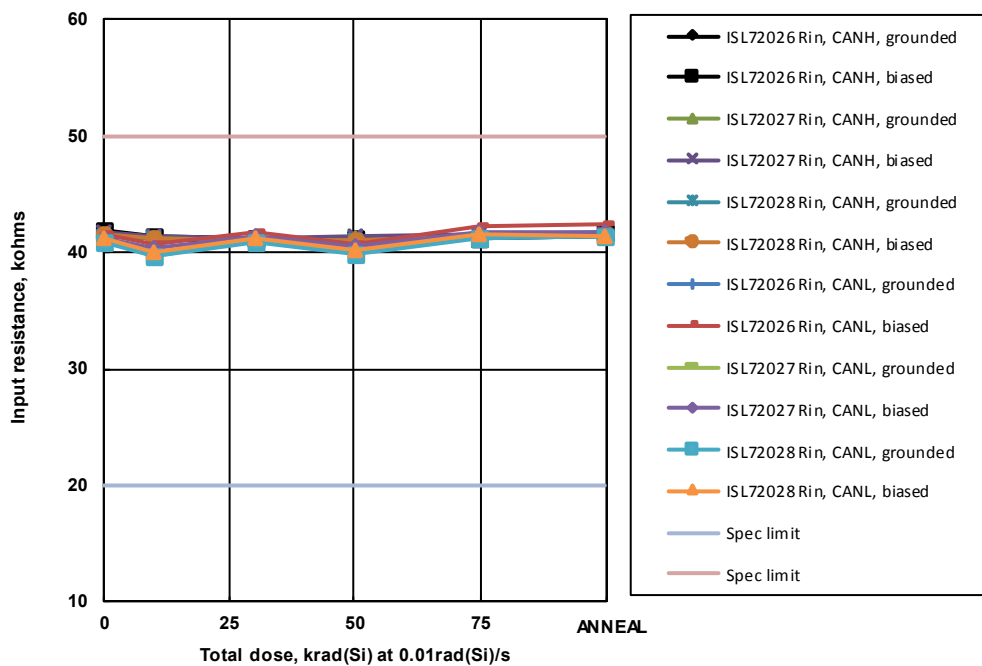

FIGURE 21. ISL72026SEH, ISL72027SEH and ISL72028SEH receiver input resistance (R_{IN}), input to ground, $D = 3V$, $LBK = RS = 0V$, as a function of low dose rate irradiation for the biased (per Figure 4) and unbiased (all pins grounded) cases. The dose rate was $0.0089 rad(Si)/s$, and the sample size for each of the six cells was 12. The post-irradiation SMD limits are $20k\Omega$ to $50k\Omega$.

Variables Data Plots (Continued)

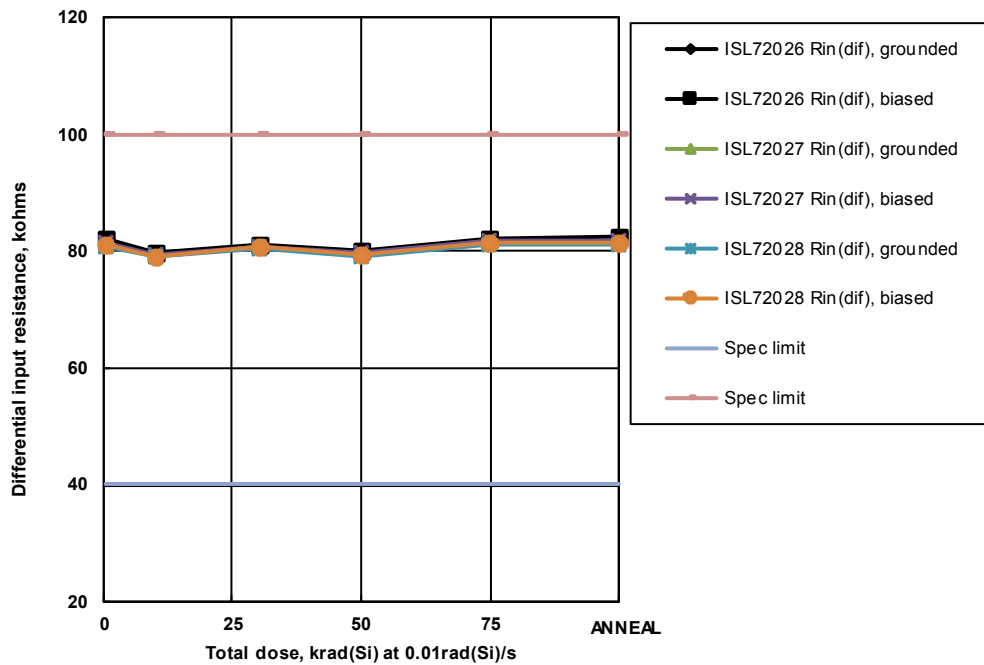

FIGURE 22. ISL72026SEH, ISL72027SEH and ISL72028SEH receiver differential input resistance (R_{IND}), input to input, $D = 3V$, $LBK = RS = 0V$, as a function of low dose rate irradiation for the biased (per Figure 4) and unbiased (all pins grounded) cases. The dose rate was 0.0089rad(Si)/s and the sample size for each of the six cells was 12. The post-irradiation SMD limits are $40\text{k}\Omega$ to $100\text{k}\Omega$.

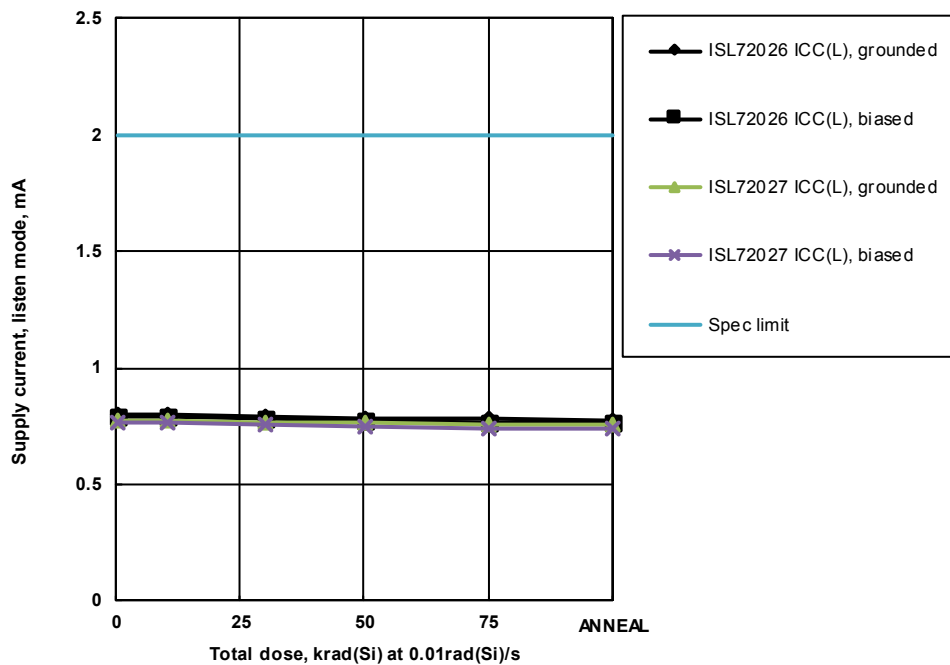

FIGURE 23. ISL72026SEH and ISL72027SEH supply current in Listen mode ($I_{CC(L)}$), $RS = D = VC_C$, as a function of low dose rate irradiation for the biased (per Figure 4) and unbiased (all pins grounded) cases. The dose rate was 0.0089rad(Si)/s and the sample size for each of the six cells was 12. The post-irradiation SMD limit is 2.0mA maximum.

Variables Data Plots (Continued)

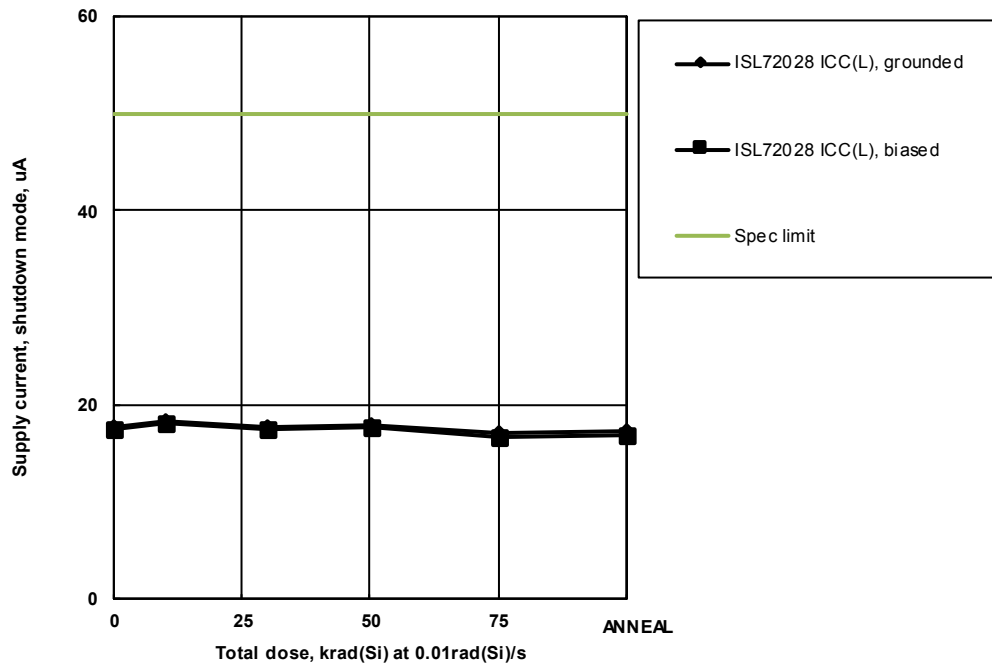

FIGURE 24. ISL72028SEH supply current in low power shutdown mode ($I_{CC(L)}$), $RS = D = V_{CC}$, as a function of low dose rate irradiation for the biased (per Figure 4) and unbiased (all pins grounded) cases. The dose rate was 0.0089rad(Si)/s and the sample size for each of the six cells was 12. The post-irradiation SMD limit is 50uA maximum.

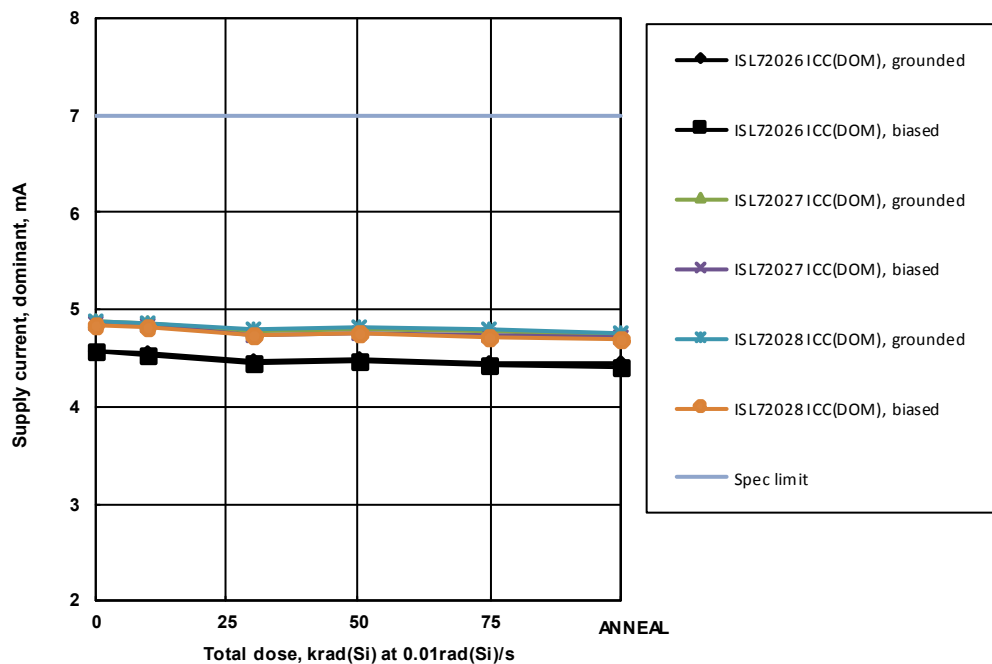

FIGURE 25. ISL72026SEH, ISL72027SEH and ISL72028SEH supply current, dominant ($I_{CC(DOM)}$), $RS = D = LBK = 0V$, as a function of low dose rate irradiation for the biased (per Figure 4) and unbiased (all pins grounded) cases. The dose rate was 0.0089rad(Si)/s and the sample size for each of the six cells was 12. The post-irradiation SMD limit is 7.0mA maximum.

Variables Data Plots (Continued)

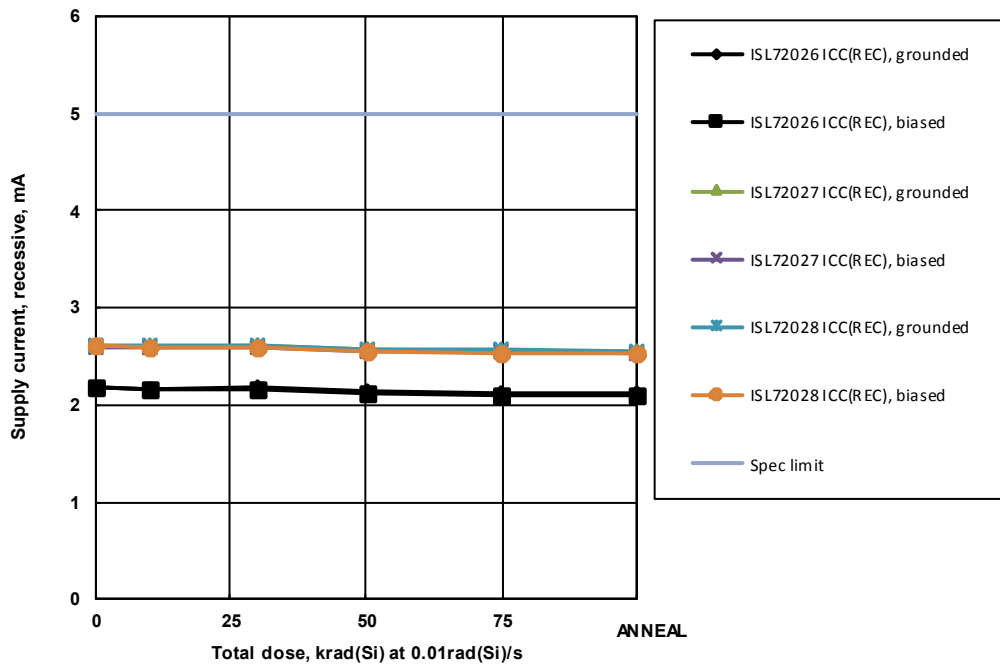

FIGURE 26. ISL72026SEH, ISL72027SEH and ISL72028SEH supply current, recessive ($I_{CC(REC)}$), $RS = LBK = 0V$, $D = V_{CC}$, as a function of low dose rate irradiation for the biased (per Figure 4) and unbiased (all pins grounded) cases. The dose rate was 0.0089 rad(Si)/s and the sample size for each of the six cells was 12. The post-irradiation SMD limit is 5.0mA maximum.

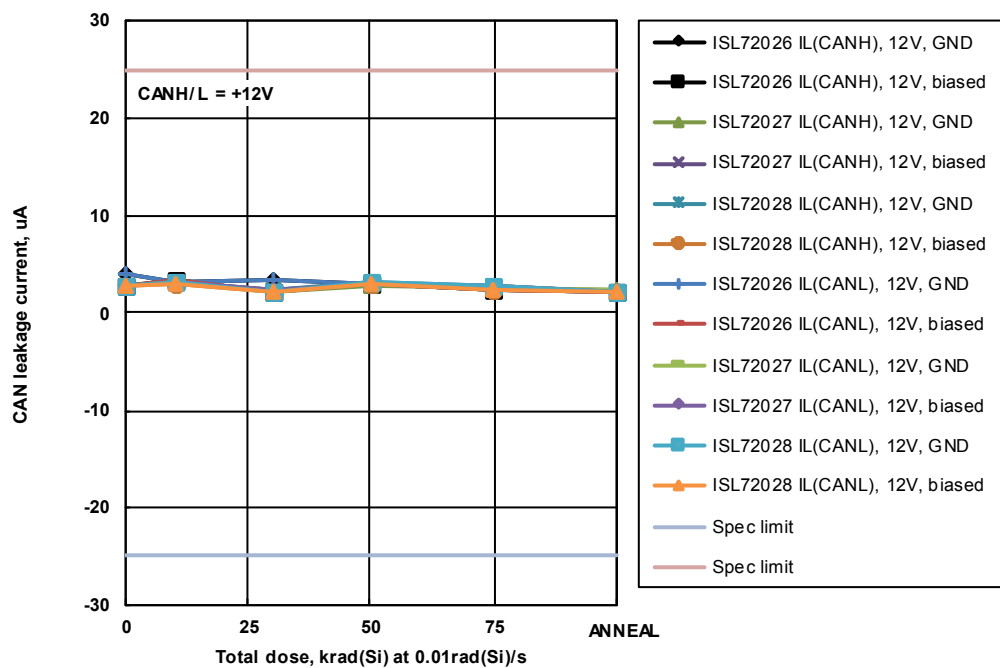

FIGURE 27. ISL72026SEH, ISL72027SEH and ISL72028SEH cold sparing CANH and CANL leakage current ($I_L(CANH)$ and $I_L(CANL)$), $V_{CC} = 0.2V$, $RS = 0V$, CANH or CANL = 12V, CANL or CANH open, $D = VS$, as a function of low dose rate irradiation for the biased (per Figure 4) and unbiased (all pins grounded) cases. The dose rate was 0.0089rad(Si)/s and the sample size for each of the six cells was 12. The post-irradiation SMD limits are -25uA to 25uA.

Variables Data Plots (Continued)

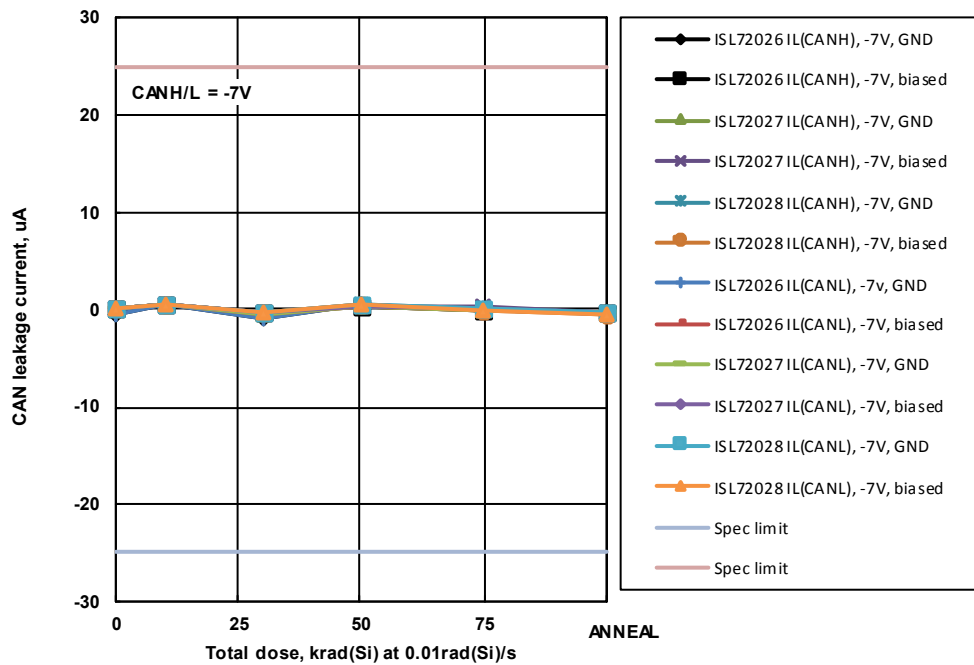

FIGURE 28. ISL72026SEH, ISL72027SEH and ISL72028SEH cold sparing CANH and CANL leakage current ($I_{L(CANH)}$ and $I_{L(CANL)}$), $V_{CC} = 0.2V$, $RS = 0V$, CANH or CANL = -7V, CANL or CANH open, D = VS, as a function of low dose rate irradiation for the biased (per Figure 4) and unbiased (all pins grounded) cases. The dose rate was 0.0089rad(Si)/s and the sample size for each of the six cells was 12. The post-irradiation SMD limits are -25 μ A to 25 μ A.

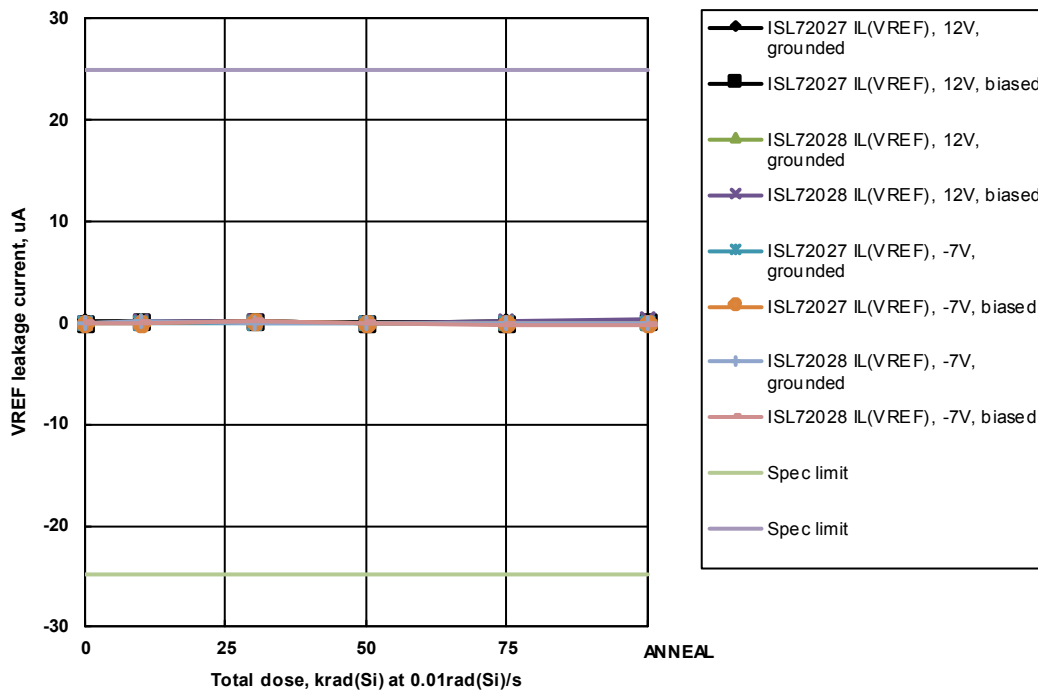

FIGURE 29. ISL72027SEH and ISL72028SEH cold sparing V_{REF} leakage current ($I_{L(VREF)}$), $V_{CC} = 0.2V$, $V_{REF} = -7V$ or 12V, D = VS, as a function of low dose rate irradiation for the biased (per Figure 4) and unbiased (all pins grounded) cases. The dose rate was 0.0089rad(Si)/s and the sample size for each of the six cells was 12. The post-irradiation SMD limits are -25 μ A to 25 μ A.

Variables Data Plots (Continued)

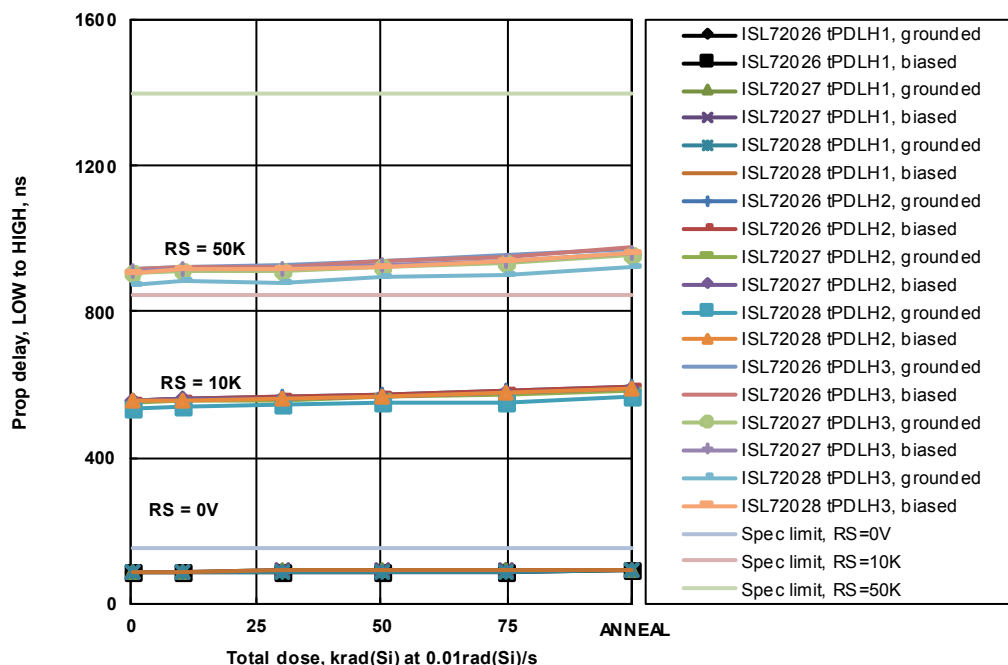

FIGURE 30. ISL72026SEH, ISL72027SEH and ISL72028SEH driver propagation delay, LOW to HIGH, RS = 0V (tPDLH1), RS = 10kΩ (tPDLH2) and RS = 50kΩ (tPDLH3), as a function of low dose rate irradiation for the biased (per Figure 4) and unbiased (all pins grounded) cases. The dose rate was 0.0089rad(Si)/s and the sample size for each of the six cells was 12. The post-irradiation SMD limits are 150ns maximum (tPDLH1), 850ns maximum (tPDLH2) and 1400ns maximum (tPDLH3).

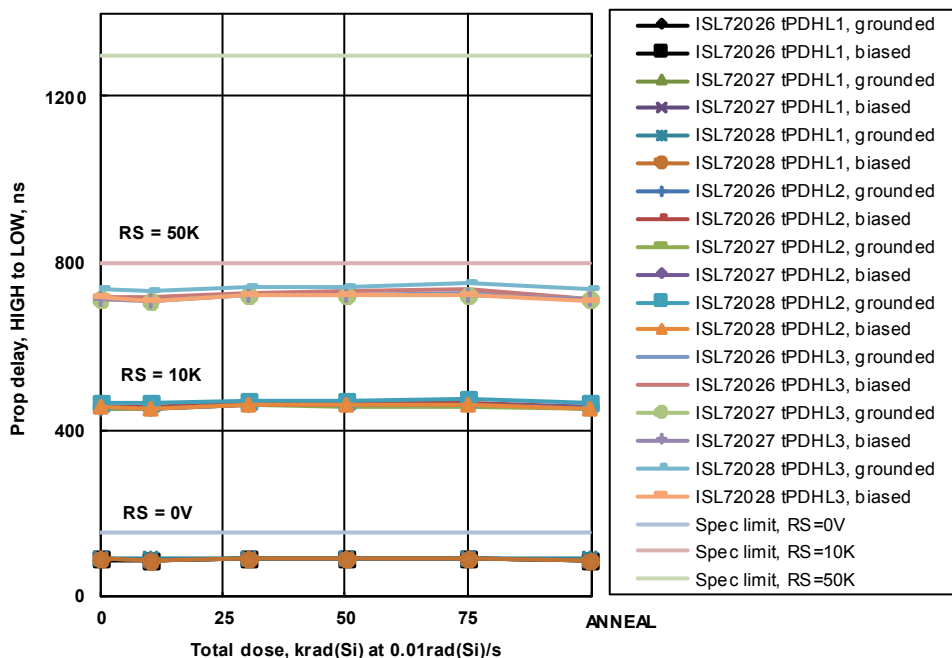

FIGURE 31. ISL72026SEH, ISL72027SEH and ISL72028SEH driver propagation delay, HIGH to LOW, RS = 0V (tPDHL1), RS = 10kΩ (tPDHL2) and RS = 50kΩ (tPDHL3), as a function of low dose rate irradiation for the biased (per Figure 4) and unbiased (all pins grounded) cases. The dose rate was 0.0089rad(Si)/s, and the sample size for each of the six cells was 12. The post-irradiation SMD limits are 155ns maximum (tPDHL1), 800ns maximum (tPDHL2) and 1300ns maximum (tPDHL3).

Variables Data Plots (Continued)

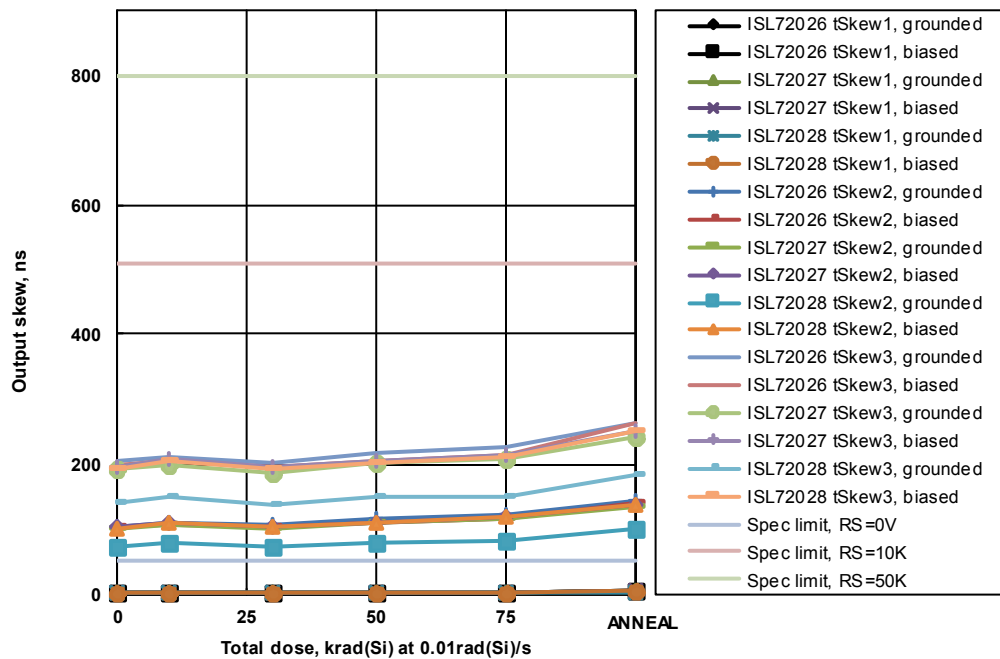

FIGURE 32. ISL72026SEH, ISL72027SEH and ISL72028SEH driver output skew ($t_{PHL} - t_{PLH}$), RS = 0V (t_{Skew1}), RS = 10k Ω (t_{Skew2}) and RS = 50k Ω (t_{Skew3}), as a function of low dose rate irradiation for the biased (per Figure 4) and unbiased (all pins grounded) cases. The dose rate was 0.0089rad(Si)/s and the sample size for each of the six cells was 12. The post-irradiation SMD limits are 50ns maximum (t_{Skew1}), 510ns maximum (t_{Skew2}) and 800ns maximum (t_{Skew3}).

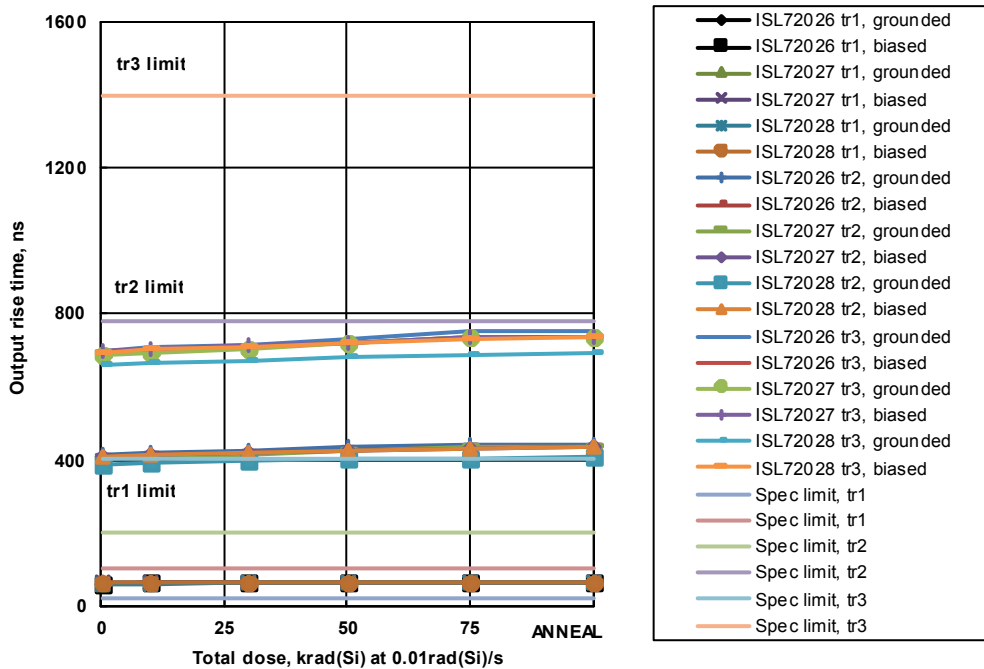

FIGURE 33. ISL72026SEH, ISL72027SEH and ISL72028SEH driver output rise time, RS = 0V (t_{r1}), RS = 10k Ω (t_{r2}) and RS = 50k Ω (t_{r3}), as a function of low dose rate irradiation for the biased (per Figure 4) and unbiased (all pins grounded) cases. The dose rate was 0.0089rad(Si)/s and the sample size for each of the six cells was 12. The post-irradiation SMD limits are 20ns to 100ns (t_{r1}), 200ns to 780ns (t_{r2}) and 400ns to 1400ns (t_{r3}).

Variables Data Plots (Continued)

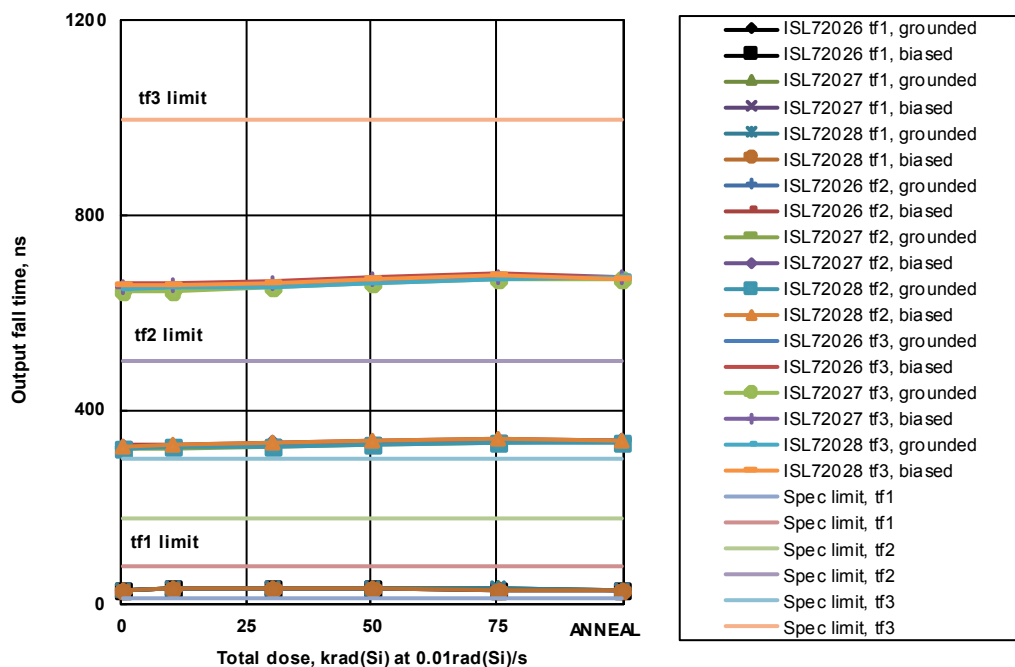

FIGURE 34. ISL72026SEH, ISL72027SEH and ISL72028SEH driver output fall time, $R_S = 0V$ (t_{f1}), $R_S = 10k\Omega$ (t_{f2}) and $R_S = 50k\Omega$ (t_{f3}), as a function of low dose rate irradiation for the biased (per Figure 4) and unbiased (all pins grounded) cases. The dose rate was $0.0089rad(Si)/s$ and the sample size for each of the six cells was 12. The post-irradiation SMD limits are 10ns to 100ns (t_{f1}), 175ns to 780ns (t_{f2}) and 300ns to 1400ns (t_{f3}).

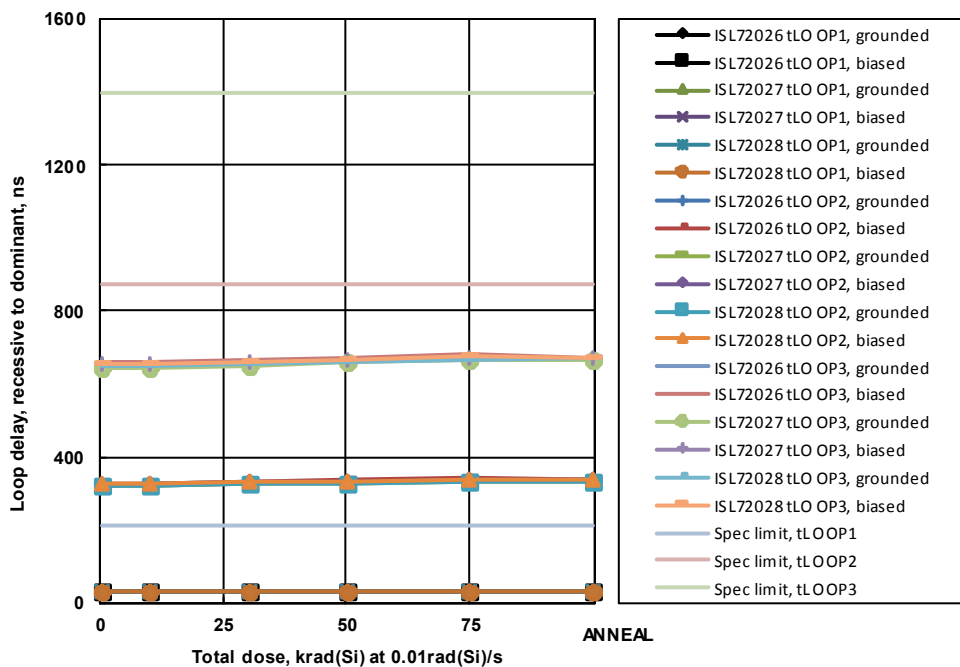

FIGURE 35. ISL72026SEH, ISL72027SEH and ISL72028SEH driver total loop delay t_{LOOP1} , driver input to receiver output, recessive to dominant, $R_S = 0V$ (t_{LOOP1}), $R_S = 10k\Omega$ (t_{LOOP2}) and $R_S = 50k\Omega$ (t_{LOOP3}), as a function of low dose rate irradiation for the biased (per Figure 4) and unbiased (all pins grounded) cases. The dose rate was $0.0089rad(Si)/s$ and the sample size for each of the six cells was 12. The post-irradiation SMD limits are 210ns maximum t_{LOOP1} , 875ns maximum t_{LOOP2} and 1400ns maximum t_{LOOP3} .

Variables Data Plots (Continued)

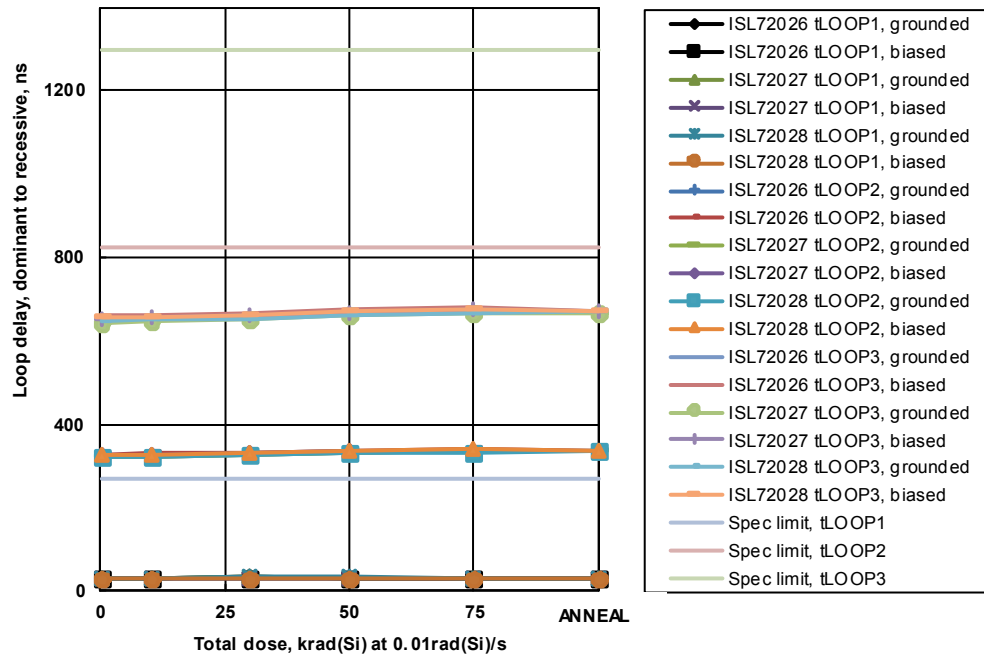

FIGURE 36. ISL72026SEH, ISL72027SEH and ISL72028SEH driver total loop delay $t_{(LOOP2)}$, driver input to receiver output, dominant to recessive, $RS = 0V$ $t_{(LOOP1)}$, $RS = 10k\Omega$ $t_{(LOOP2)}$ and $RS = 50k\Omega$ $t_{(LOOP3)}$, as a function of low dose rate irradiation for the biased (per Figure 4) and unbiased (all pins grounded) cases. The dose rate was 0.0089rad(Si)/s and the sample size for each of the six cells was 12. The post-irradiation SMD limits are 270ns maximum $t_{(LOOP1)}$, 825ns maximum $t_{(LOOP2)}$ and 1300ns maximum $t_{(LOOP3)}$.

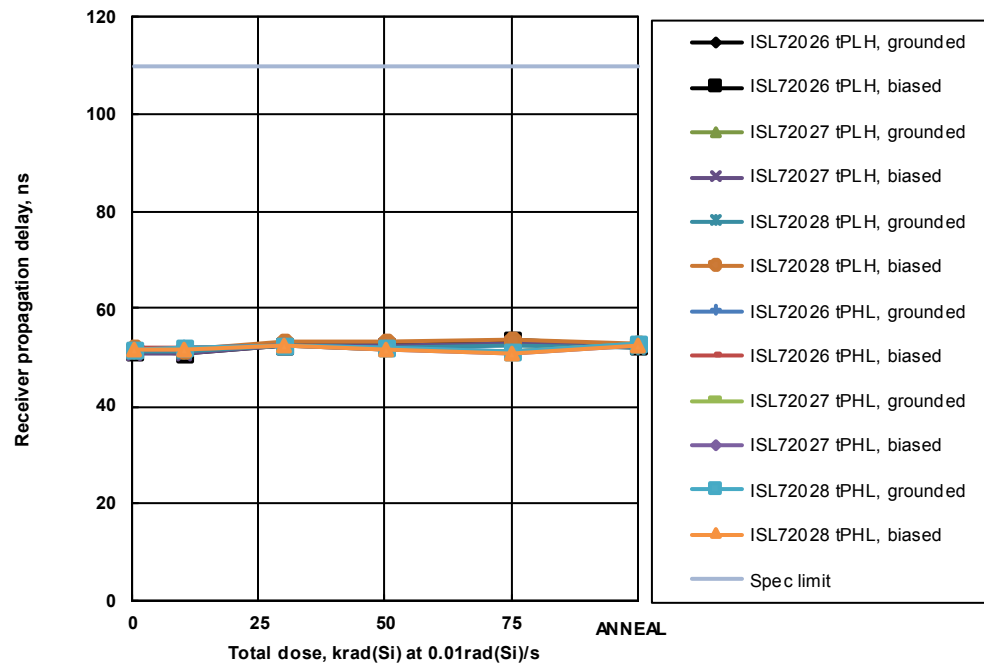

FIGURE 37. ISL72026SEH, ISL72027SEH and ISL72028SEH receiver propagation delay (t_{PLH} and t_{PHL}), LOW to HIGH and HIGH to LOW, as a function of low dose rate irradiation for the biased (per Figure 4) and unbiased (all pins grounded) cases. The dose rate was 0.0089rad(Si)/s and the sample size for each of the six cells was 12. The post-irradiation SMD limit is 110ns maximum.

Variables Data Plots (Continued)

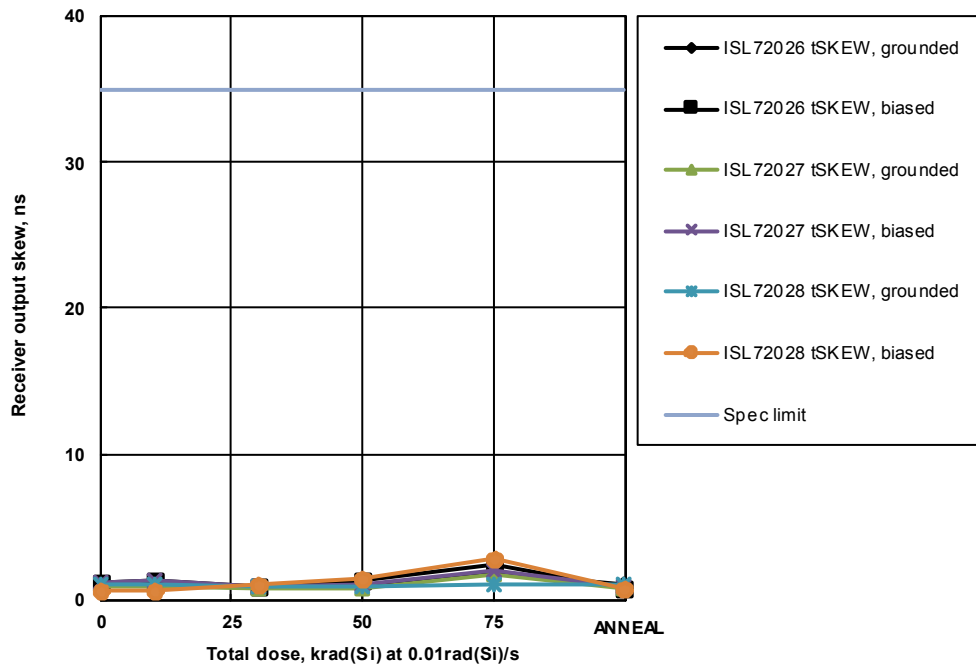

FIGURE 38. ISL72026SEH, ISL72027SEH and ISL72028SEH receiver skew ($t_{SKEW1} = t_{PHL} - t_{PLH}$) as a function of low dose rate irradiation for the biased (per Figure 4) and unbiased (all pins grounded) cases. The dose rate was 0.0089rad(Si)/s and the sample size for each of the six cells was 12. The post-irradiation SMD limit is 35ns maximum.

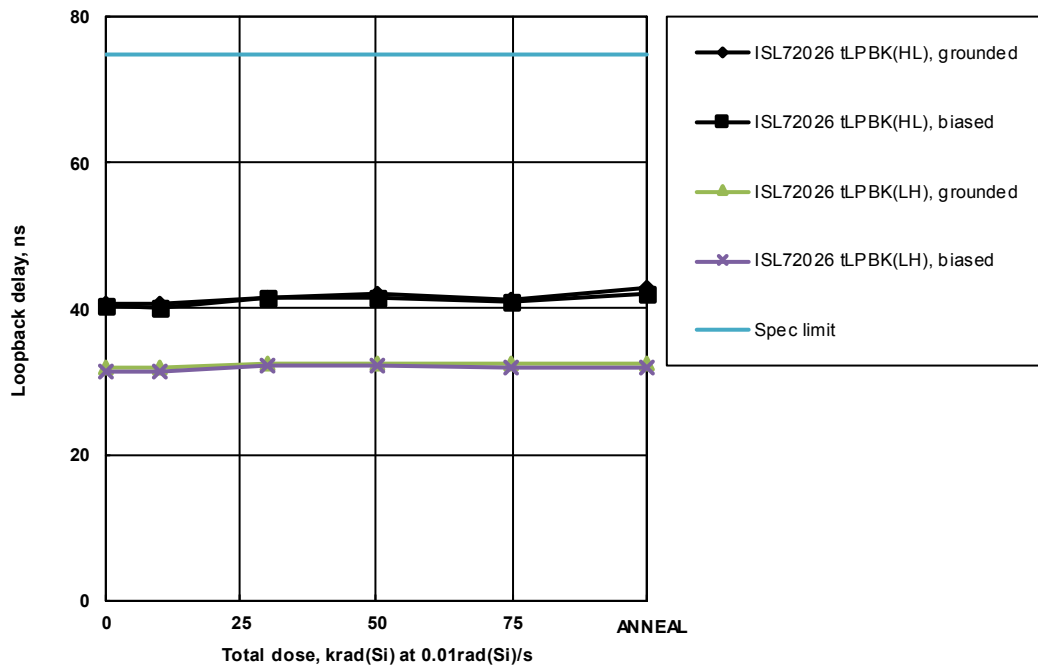

FIGURE 39. ISL72026SEH loopback delay (t_{LBK}), IO to receiver output as a function of low dose rate irradiation for the biased (per Figure 4) and unbiased (all pins grounded) cases. The dose rate was 0.0089rad(Si)/s and the sample size for each of the six cells was 12. The post-irradiation SMD limit is 75ns maximum.

Variables Data Plots (Continued)

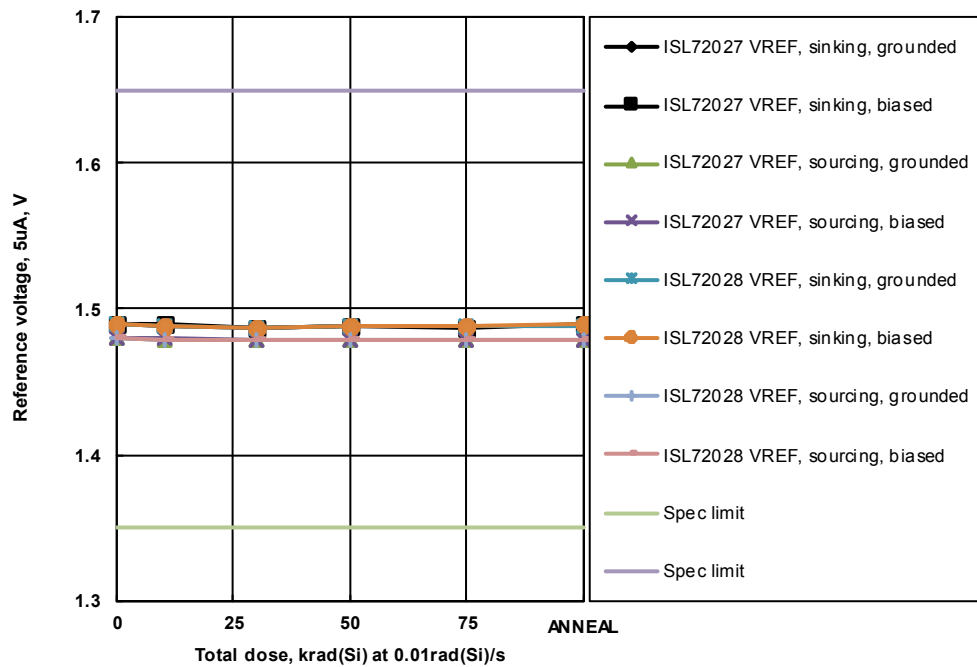

FIGURE 40. ISL72027SEH and ISL72028SEH reference pin voltage (V_{REF}), 5µA sourcing and sinking, as a function of low dose rate irradiation for the biased (per Figure 4) and unbiased (all pins grounded) cases. The dose rate was 0.0089rad(Si)/s and the sample size for each of the six cells was 12. The post-irradiation SMD limits are 1.35V to 1.65V.

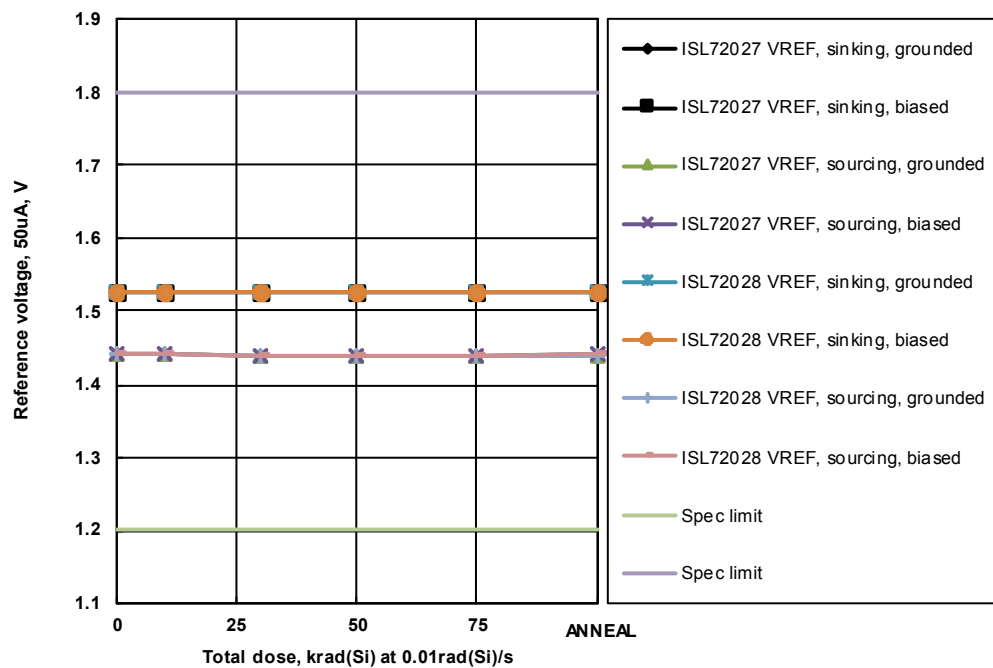

FIGURE 41. ISL72027SEH and ISL72028SEH reference pin voltage (V_{REF}), 50µA sourcing and sinking, as a function of low dose rate irradiation for the biased (per Figure 4) and unbiased (all pins grounded) cases. The dose rate was 0.0089rad(Si)/s and the sample size for each of the six cells was 12. The post-irradiation SMD limits are 1.2V to 1.8V.

Variables Data Plots (Continued)

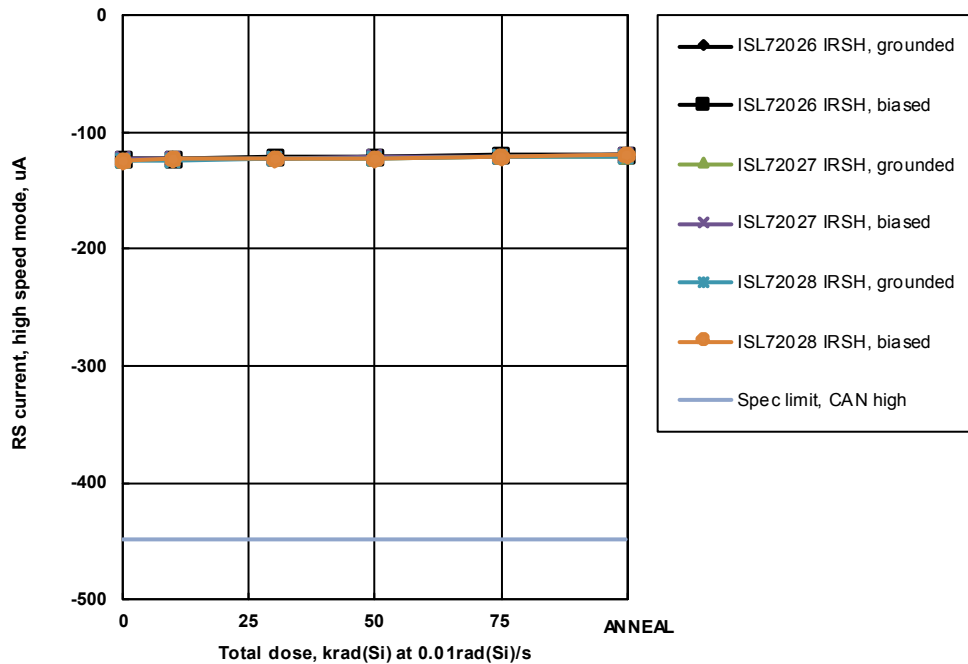

FIGURE 42. ISL72026SEH, ISL72027SEH and ISL72028SEH RS input current (I_{RSH}), high speed mode, as a function of low dose rate irradiation for the biased (per Figure 4) and unbiased (all pins grounded) cases. The dose rate was 0.0089rad(Si)/s and the sample size for each of the six cells was 12. The post-irradiation SMD limit is -450 μ A minimum.

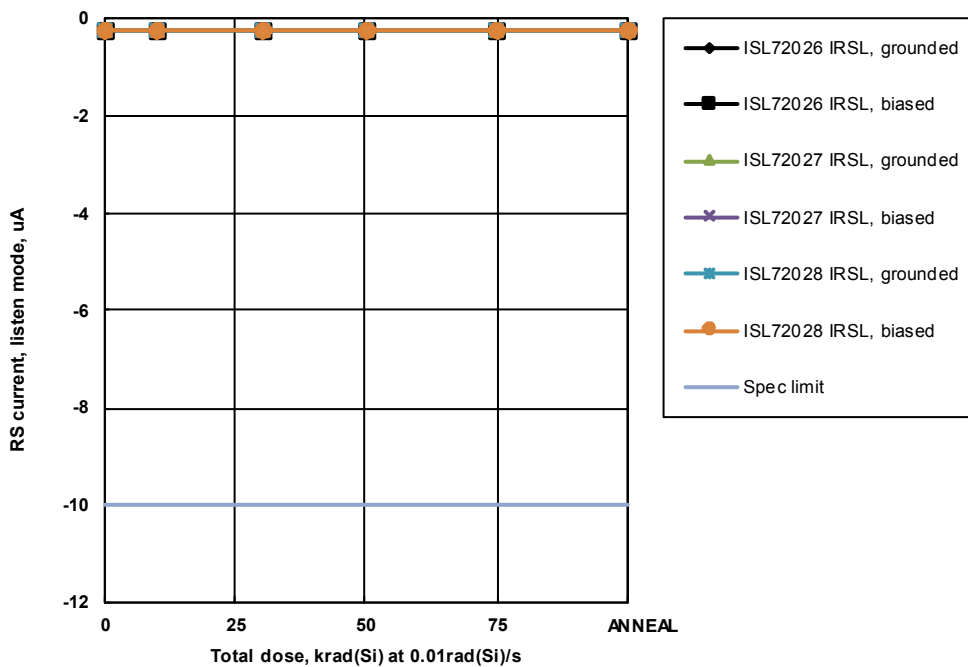

FIGURE 43. ISL72026SEH, ISL72027SEH and ISL72028SEH RS input current (I_{RSL}), listen mode, as a function of low dose rate irradiation for the biased (per Figure 4) and unbiased (all pins grounded) cases. The dose rate was 0.0089rad(Si)/s and the sample size for each of the six cells was 12. The post-irradiation SMD limit is -10 μ A minimum

Conclusion

This document reports results of a total dose test of the ISL72026SEH, ISL72027SEH and ISL72028SEH Controller Area Network (CAN) transceivers. The test was conducted in order to determine the sensitivity of the parts to the low dose rate total dose environment found in nearly all space applications. Parts were tested to 75krad(Si) at low dose rate under biased and unbiased conditions, as outlined in MIL-STD-883 Test Method 1019, and were then subjected to a high temperature biased anneal at +100°C for 168 hours.

ATE characterization testing at downpoints showed no rejects to the SMD Group A parametric limits (indicated by a 'Bin 1' category) after biased and grounded irradiation at low dose rate and after the 168 hour +100°C biased anneal. Attributes data is presented in [Table 3](#), while variables data for selected parameters is plotted in [Figures 5](#) through [43](#). No differences between biased and unbiased irradiation were noted and the part is not considered bias sensitive.

TABLE 3. REPORTED PARAMETERS

FIGURE	PARAMETER	LIMIT LOW	LIMIT HIGH	UNIT	NOTES
5	Dominant bus output voltage	2.25	3.0	V	D = 0V
	Dominant bus output voltage	0.1	1.25	V	D = 0V
6	Recessive bus output voltage	1.8	2.7	V	D = 3V
	Recessive bus output voltage	1.8	2.8	V	D = 3V
7	Dominant differential output voltage	1.5	3.0	V	D = 0V
	Dominant differential output voltage	1.2	3.0	V	D = 0V
8	Recessive differential output voltage	-120	12	mV	D = 3V
	Recessive differential output voltage	-500	50	mV	D = 3V
9	Logic HIGH input current	-30	30	μA	D input
	Logic LOW input current	-30	30	μA	D input
10	Output short-circuit current	-250	-	mA	CANH = -7V, CANL open
	Output short-circuit current	-	250	mA	CANL = 12V, CANH open
11	Output short-circuit current	-1.0	-	mA	CANH = 12V, CANL open
	Output short-circuit current	-	1.0	mA	CANL = -7V, CANH open
12	Input threshold voltage, rising	-	900	mV	RS = 0V, 10k and 50k
	Input threshold voltage, falling	500	-	mV	RS = 0V, 10k and 50k
13	Input hysteresis voltage	40	-	mV	
14	Input threshold voltage, rising, loopback mode	-	1150	mV	RS = 0V, 10k and 50k
	Input threshold voltage, falling, loopback mode	525	-	mV	RS = 0V, 10k and 50k
15	Input hysteresis voltage, loopback mode	50	-	mV	
16	Receiver output HIGH voltage	2.4	-	V	I _{OUT} = -4mA
	Receiver output LOW voltage	-	0.4	V	I _{OUT} = 4mA
17	CAN bus input current	-	500	μA	CANH or CANL = 12V
18	CAN bus input current, supply off	-	250	μA	CANH or CANL = 12V, V _{CC} = 0V
19	CAN bus input current	-400	-	μA	CANH or CANL = -7V
20	CAN bus input current, supply off	-150	-	μA	CANH or CANL = -7V, V _{CC} = 0V
21	Input resistance	20.0	50.0	kΩ	
22	Differential input resistance	40.0	100.0	kΩ	
23	Supply current, listen mode	-	2.0	mA	
24	Supply current, low current shutdown mode	-	50.0	μA	
25	Supply current, dominant	-	7.0	mA	

TABLE 3. REPORTED PARAMETERS

FIGURE	PARAMETER	LIMIT LOW	LIMIT HIGH	UNIT	NOTES
26	Supply current, recessive	-	5.0	mA	
27	CANH leakage current	-30.0	30.0	μA	
28	CANL leakage current	-30.0	30.0	μA	
29	VREF leakage current	-30.0	30.0	μA	
30	Driver propagation delay, LOW to HIGH	-	150.0	ns	RS = 0V
	Driver propagation delay, LOW to HIGH	-	850.0	ns	RS = 10k
	Driver propagation delay, LOW to HIGH	-	1400.0	ns	RS = 50k
31	Driver propagation delay, HIGH to LOW	-	155.0	ns	RS = 0V
	Driver propagation delay, HIGH to LOW	-	800.0	ns	RS = 10k
	Driver propagation delay, HIGH to LOW	-	1300.0	ns	RS = 50k
32	Driver output skew	-	50.0	ns	RS = 0V
	Driver output skew	-	510.0	ns	RS = 10k
	Driver output skew	-	800.0	ns	RS = 50k
33	Driver output rise time	20.0	100.0	ns	RS = 0V
	Driver output rise time	200.0	780.0	ns	RS = 10k
	Driver output rise time	400.0	1400.0	ns	RS = 50k
34	Driver output fall time	10.0	75.0	ns	RS = 0V
	Driver output fall time	175.0	500.0	ns	RS = 10k
	Driver output fall time	300.0	1000.0	ns	RS = 50k
35	Total loop delay, dominant to recessive	-	210.0	ns	RS = 0V
	Total loop delay, dominant to recessive	-	875.0	ns	RS = 10k
	Total loop delay, dominant to recessive	-	1400.0	ns	RS = 50k
36	Total loop delay, recessive to dominant	-	270.0	ns	RS = 0V
	Total loop delay, recessive to dominant	-	825.0	ns	RS = 10k
	Total loop delay, recessive to dominant	-	1300.0	ns	RS = 50k
37	Receiver propagation delay, LOW to HIGH	-	110.0	ns	
	Receiver propagation delay, HIGH to LOW	-	110.0	ns	
38	Receiver skew	-	35.0	ns	
39	Loopback delay, IO to receiver output	-	75.0	ns	
40	VREF pin voltage	1.35	1.65	V	-5μA to 5μA
41	VREF pin voltage	1.2	1.8	V	-50μA to 50μA
42	RS input current, high speed mode	-450.0	-	μA	
43	RS input current, listen mode	-10.0	-	μA	

NOTES:

3. Limits are taken from Standard Microcircuit Drawing (SMD) [5962-15228](#).

Notice

1. Descriptions of circuits, software and other related information in this document are provided only to illustrate the operation of semiconductor products and application examples. You are fully responsible for the incorporation or any other use of the circuits, software, and information in the design of your product or system. Renesas Electronics disclaims any and all liability for any losses and damages incurred by you or third parties arising from the use of these circuits, software, or information.
 2. Renesas Electronics hereby expressly disclaims any warranties against and liability for infringement or any other claims involving patents, copyrights, or other intellectual property rights of third parties, by or arising from the use of Renesas Electronics products or technical information described in this document, including but not limited to, the product data, drawings, charts, programs, algorithms, and application examples.
 3. No license, express, implied or otherwise, is granted hereby under any patents, copyrights or other intellectual property rights of Renesas Electronics or others.
 4. You shall not alter, modify, copy, or reverse engineer any Renesas Electronics product, whether in whole or in part. Renesas Electronics disclaims any and all liability for any losses or damages incurred by you or third parties arising from such alteration, modification, copying or reverse engineering.
 5. Renesas Electronics products are classified according to the following two quality grades: "Standard" and "High Quality". The intended applications for each Renesas Electronics product depends on the product's quality grade, as indicated below.
"Standard": Computers; office equipment; communications equipment; test and measurement equipment; audio and visual equipment; home electronic appliances; machine tools; personal electronic equipment; industrial robots; etc.
"High Quality": Transportation equipment (automobiles, trains, ships, etc.); traffic control (traffic lights); large-scale communication equipment; key financial terminal systems; safety control equipment; etc.
Unless expressly designated as a high reliability product or a product for harsh environments in a Renesas Electronics data sheet or other Renesas Electronics document, Renesas Electronics products are not intended or authorized for use in products or systems that may pose a direct threat to human life or bodily injury (artificial life support devices or systems; surgical implantations; etc.), or may cause serious property damage (space system; undersea repeaters; nuclear power control systems; aircraft control systems; key plant systems; military equipment; etc.). Renesas Electronics disclaims any and all liability for any damages or losses incurred by you or any third parties arising from the use of any Renesas Electronics product that is inconsistent with any Renesas Electronics data sheet, user's manual or other Renesas Electronics document.
 6. When using Renesas Electronics products, refer to the latest product information (data sheets, user's manuals, application notes, "General Notes for Handling and Using Semiconductor Devices" in the reliability handbook, etc.), and ensure that usage conditions are within the ranges specified by Renesas Electronics with respect to maximum ratings, operating power supply voltage range, heat dissipation characteristics, installation, etc. Renesas Electronics disclaims any and all liability for any malfunctions, failure or accident arising out of the use of Renesas Electronics products outside of such specified ranges.
 7. Although Renesas Electronics endeavors to improve the quality and reliability of Renesas Electronics products, semiconductor products have specific characteristics, such as the occurrence of failure at a certain rate and malfunctions under certain use conditions. Unless designated as a high reliability product or a product for harsh environments in a Renesas Electronics data sheet or other Renesas Electronics document, Renesas Electronics products are not subject to radiation resistance design. You are responsible for implementing safety measures to guard against the possibility of bodily injury, injury or damage caused by fire, and/or danger to the public in the event of a failure or malfunction of Renesas Electronics products, such as safety design for hardware and software, including but not limited to redundancy, fire control and malfunction prevention, appropriate treatment for aging degradation or any other appropriate measures. Because the evaluation of microcomputer software alone is very difficult and impractical, you are responsible for evaluating the safety of the final products or systems manufactured by you.
 8. Please contact a Renesas Electronics sales office for details as to environmental matters such as the environmental compatibility of each Renesas Electronics product. You are responsible for carefully and sufficiently investigating applicable laws and regulations that regulate the inclusion or use of controlled substances, including without limitation, the EU RoHS Directive, and using Renesas Electronics products in compliance with all these applicable laws and regulations. Renesas Electronics disclaims any and all liability for damages or losses occurring as a result of your noncompliance with applicable laws and regulations.
 9. Renesas Electronics products and technologies shall not be used for or incorporated into any products or systems whose manufacture, use, or sale is prohibited under any applicable domestic or foreign laws or regulations. You shall comply with any applicable export control laws and regulations promulgated and administered by the governments of any countries asserting jurisdiction over the parties or transactions.
 10. It is the responsibility of the buyer or distributor of Renesas Electronics products, or any other party who distributes, disposes of, or otherwise sells or transfers the product to a third party, to notify such third party in advance of the contents and conditions set forth in this document.
 11. This document shall not be reprinted, reproduced or duplicated in any form, in whole or in part, without prior written consent of Renesas Electronics.
 12. Please contact a Renesas Electronics sales office if you have any questions regarding the information contained in this document or Renesas Electronics products.
- (Note 1) "Renesas Electronics" as used in this document means Renesas Electronics Corporation and also includes its directly or indirectly controlled subsidiaries.
(Note 2) "Renesas Electronics product(s)" means any product developed or manufactured by or for Renesas Electronics.

(Rev.4.0-1 November 2017)



SALES OFFICES

Renesas Electronics Corporation

<http://www.renesas.com>

Refer to "<http://www.renesas.com/>" for the latest and detailed information.

Renesas Electronics America Inc.
1001 Murphy Ranch Road, Milpitas, CA 95035, U.S.A.
Tel: +1-408-432-8888, Fax: +1-408-434-5351

Renesas Electronics Canada Limited
9251 Yonge Street, Suite 8309 Richmond Hill, Ontario Canada L4C 9T3
Tel: +1-905-237-2004

Renesas Electronics Europe Limited
Dukes Meadow, Millboard Road, Bourne End, Buckinghamshire, SL8 5FH, U.K
Tel: +44-1628-651-700, Fax: +44-1628-651-804

Renesas Electronics Europe GmbH
Arcadiastrasse 10, 40472 Düsseldorf, Germany
Tel: +49-211-6503-0, Fax: +49-211-6503-1327

Renesas Electronics (China) Co., Ltd.
Room 1709 Quantum Plaza, No.27 ZhichunLu, Haidian District, Beijing, 100191 P. R. China
Tel: +86-10-8235-1155, Fax: +86-10-8235-7679

Renesas Electronics (Shanghai) Co., Ltd.
Unit 301, Tower A, Central Towers, 555 Langao Road, Putuo District, Shanghai, 200333 P. R. China
Tel: +86-21-2226-0888, Fax: +86-21-2226-0999

Renesas Electronics Hong Kong Limited
Unit 1601-1611, 16/F., Tower 2, Grand Century Place, 193 Prince Edward Road West, Mongkok, Kowloon, Hong Kong
Tel: +852-2265-6688, Fax: +852-2886-9022

Renesas Electronics Taiwan Co., Ltd.
13F, No. 363, Fu Shing North Road, Taipei 10543, Taiwan
Tel: +886-2-8175-9600, Fax: +886-2-8175-9670

Renesas Electronics Singapore Pte. Ltd.
80 Bendemeer Road, Unit #06-02 Hyflux Innovation Centre, Singapore 339949
Tel: +65-6213-0200, Fax: +65-6213-0300

Renesas Electronics Malaysia Sdn.Bhd.
Unit 1207, Block B, Menara Amcorp, Amcorp Trade Centre, No. 18, Jln Persiaran Barat, 46050 Petaling Jaya, Selangor Darul Ehsan, Malaysia
Tel: +60-3-7955-9390, Fax: +60-3-7955-9510

Renesas Electronics India Pvt. Ltd.
No.777C, 100 Feet Road, HAL 2nd Stage, Indiranagar, Bangalore 560 038, India
Tel: +91-80-67208700, Fax: +91-80-67208777

Renesas Electronics Korea Co., Ltd.
17F, KAMCO Yangjae Tower, 262, Gangnam-daero, Gangnam-gu, Seoul, 06265 Korea
Tel: +82-2-558-3737, Fax: +82-2-558-5338