

## Introduction

This report provides the results of the Total Ionizing Dose (TID) testing of the [ISL72026CSEH](#), [ISL72027CSEH](#), and [ISL72028CSEH](#) Controller Area Network (CAN) transceivers. The test was conducted to determine the sensitivity of the parts to the total dose environment. Irradiations were performed at Low Dose Rate (LDR) to 75krad(Si) at 0.01rad(Si)/s under biased and grounded conditions and were followed by a biased anneal at +100°C for 168 hours. Irradiations were also performed at High Dose Rate (HDR) to 150krad(Si) at 54.6rad(Si)/s under biased and grounded conditions and were followed by biased anneals at +100°C for 168 hours. For the post-HDR anneals the sample populations were split following the 100krad(Si) exposure; half the population was annealed at that time and the second half of the population was exposed to an additional 50krad(Si) and then annealed. No rejects to the SMD parametric limits were encountered at any downpoints.

## Related Literature

For a full list of related documents, visit our website

- [ISL72026CSEH](#)
- [ISL72027CSEH](#)
- [ISL72028CSEH](#)

## Part Description

The Intersil ISL7202xCSEH product family consists of the ISL72026CSEH, ISL72027CSEH, and ISL72028CSEH, which differ in functionality as outlined in the following. These parts are 3.3V radiation tolerant Controller Area Network (CAN) transceivers that are compatible with the ISO11898-2 standard. Applications include serial communications in satellites and aerospace, as well as communications and telemetry data processing in harsh industrial environments. The transceiver can transmit and receive at bus speeds of up to 1Mbps. The devices are designed to operate over a common-mode range of -7V to +12V with a maximum of 120 nodes. The devices have three discrete selectable driver rise/fall time options, a listen mode feature, a loopback test feature (ISL72026CSEH), and a split termination output (ISL72027CSEH and ISL72028CSEH).

The Receiver (Rx) inputs feature a “full fail-safe” design, which ensures a logic high receiver output if the Rx inputs are floating, shorted, or terminated but not driven. The parts are available in an 8 Ld hermetic ceramic flatpack and die form and operates over the -55°C to +125°C temperature range. The logic inputs are compatible with 5V and 3.3V systems. The three parts use the same die and the specific functionality is selected by wire bonding diagram.

The use of redundant bus transceivers is common in high reliability systems. In this arrangement, both active and quiescent devices can be present simultaneously on the bus with the quiescent devices powered down as cold spares. To support cold sparing, the powered-down ISL7202xCSEH transceiver ( $V_{CC} < 200\text{mV}$ ) has a resistance between the VREF pin and the CANH pin, or the CANL pin and the  $V_{CC}$  supply rail of  $>480\text{k}\Omega$  (max) with a typical resistance of  $>2\text{M}\Omega$ . In a powered down transceiver, the resistance between CANH and CANL has a typical resistance of  $80\text{k}\Omega$ .

The individual part descriptions are as follows:

- ISL72026CSEH: CAN transceiver, 1Mbps, listen mode, loopback
- ISL72027CSEH: CAN transceiver, 1Mbps, listen mode, split termination output
- ISL72028CSEH: CAN transceiver, 1Mbps, low power shutdown, split termination output

For more information about the CAN protocol, refer to the relevant Intersil datasheet. [Figures 1, 2, and 3](#) show the functional diagrams for all three variants, and [Table 1](#) shows their pin assignments.

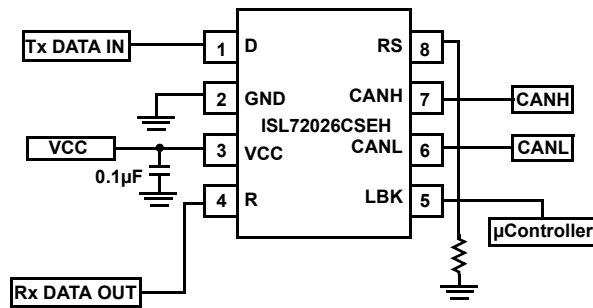

Figure 1. ISL72026CSEH Functional Diagram

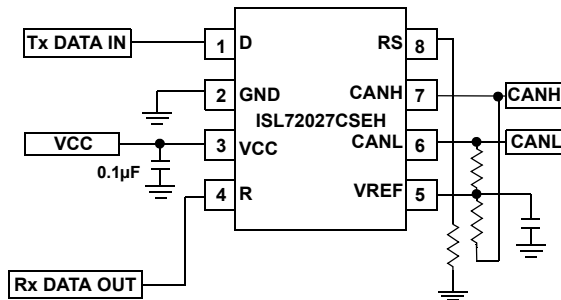

Figure 2. ISL72027CSEH Functional Diagram

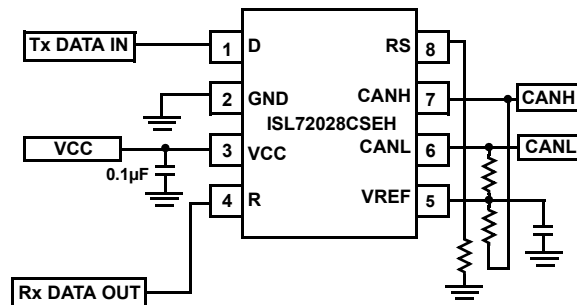

Figure 3. ISL72028CSEH Functional Diagram

Table 1. ISL7202xCSEH Pinouts

Pin Number	ISL72026CSEH	ISL72027CSEH	ISL72028CSEH
	Pin Name		
1	D	D	D
2	GND	GND	GND
3	VCC	VCC	VCC
4	R	R	R
5	LBK	VREF	VREF
6	CANL	CANL	CANL
7	CANH	CANH	CANH
8	RS	RS	RS
Package lid	Tied internally to pin 2 (GND)	Tied internally to pin 2 (GND)	Tied internally to pin 2 (GND)

## 1. Test Description

### 1.1 Irradiation Facilities

The low dose rate irradiations were performed using a Hopewell Designs N40 panoramic low dose rate  $^{60}\text{Co}$  irradiator at the Intersil facility in Palm Bay, Florida. The dose rate was  $0.0089\text{rad}(\text{Si})/\text{s}$  ( $8.9\text{mrad}(\text{Si})/\text{s}$ ), in accordance with MIL-STD-883 Method 1019. The high dose rate irradiations were performed using a Gammacell 220 irradiator also located in the Intersil Palm Bay facility. The high dose rate was  $54.6\text{rad}(\text{Si})/\text{s}$ . Both irradiations used a PbAl spectrum hardening filter to shield the test board and devices under test against low energy secondary gamma radiation.

### 1.2 Test Fixturing

[Figure 4](#) shows the configuration and power supply sequencing used for biased irradiation.

### 1.3 ISL7202xCSEH Radiation Schematic

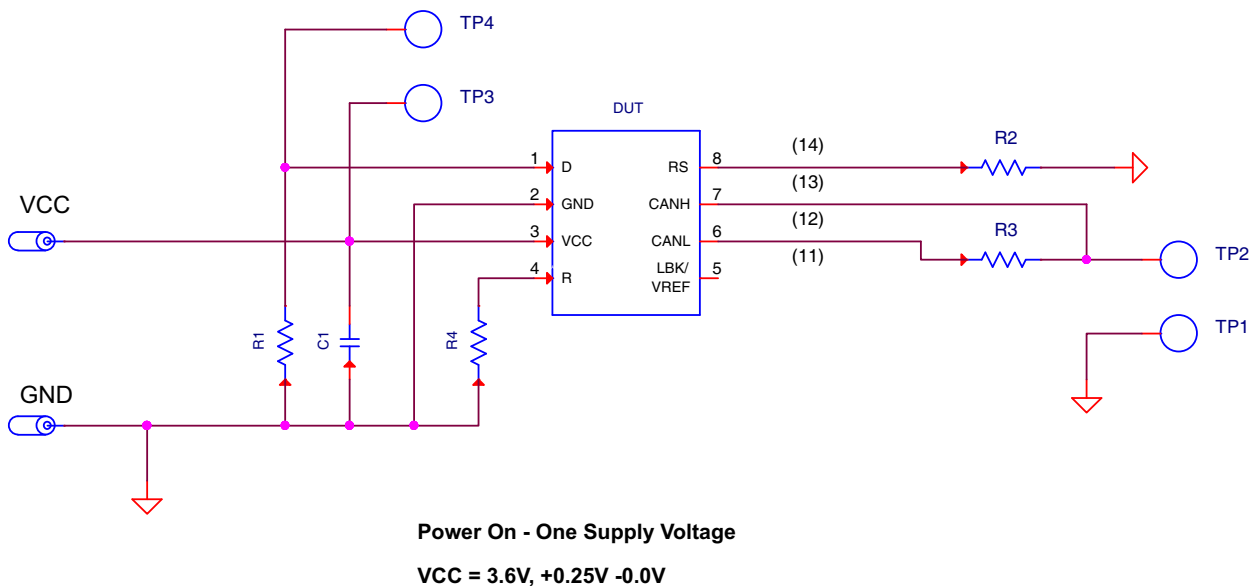

Figure 4. Irradiation Bias Configuration for the ISL7202xCSEH

### 1.4 Characterization Equipment and Procedures

All electrical testing was performed outside the irradiator using production Automated Test Equipment (ATE) with data logging of all parameters at each downpoint. All downpoint electrical testing was performed at room temperature.

### 1.5 Experimental Matrix

Testing proceeded according to the guidelines of MIL-STD-883 Test Method 1019. The experimental matrix consisted of twelve samples irradiated under bias and twelve samples irradiated with all pins grounded for each of the three part types. Three control units were used.

Samples of the ISL72026CSEH, ISL72027CSEH, and ISL72028CSEH were drawn from development lot J676671.1 and were packaged in the production hermetic 8 Ld ceramic flatpack, package code KCR. The samples were processed through the standard burn-in cycle and were screened to SMD 5962-15228 limits at room, low, and high temperatures before irradiation.

## 1.6 Downpoints

Low dose rate downpoints were 0krad(Si), 10krad(Si), 30krad(Si), 50krad(Si), and 75krad(Si). The samples were subjected to a high-temperature biased anneal for 168 hours at +100°C following irradiation.

High dose rate downpoints were 0krad(Si), 10krad(Si), 30krad(Si), 50krad(Si), 75krad(Si), 100krad(Si), and 150krad(Si), with half the samples (6) subjected to a high temperature biased anneal for 168 hours at +100°C following the 100krad(Si) irradiation and the remaining 6 units undergoing the same anneal after 150krad(Si).

## 2. Results

### 2.1 Attributes Data

Testing at low dose rate of the ISL72026CSEH, ISL72027CSEH, and ISL72028CSEH showed no reject devices after irradiation or anneal. [Table 2](#) summarizes the total dose results.

**Table 2. ISL72026CSEH, ISL72027CSEH, and ISL72028CSEH Total Dose Test Attributes Data**

Part	Rate	Bias	Sample Size	Downpoint	Bin 1 ( <a href="#">Note 1</a> )	Rejects
ISL72026CSEH	0.0089rad(Si)/s	<a href="#">Figure 4</a>	12	Pre-irradiation	12	
				10krad(Si)	12	0
				30krad(Si)	12	0
				50krad(Si)	12	0
				75krad(Si)	12	0
				Anneal, 168 hours at +100°C	12	0
ISL72026CSEH	0.0089rad(Si)/s	Grounded	12	Pre-irradiation	12	
				10krad(Si)	12	0
				30krad(Si)	12	0
				50krad(Si)	12	0
				75krad(Si)	12	0
				Anneal, 168 hours at +100°C	12	0
ISL72027CSEH	0.0089rad(Si)/s	<a href="#">Figure 4</a>	12	Pre-irradiation	12	
				10krad(Si)	12	0
				30krad(Si)	12	0
				50krad(Si)	12	0
				75 krad(Si)	12	0
				Anneal, 168 hours at +100°C	12	0
ISL72027CSEH	0.0089rad(Si)/s	Grounded	12	Pre-irradiation	12	
				10krad(Si)	12	0
				30krad(Si)	12	0
				50krad(Si)	12	0
				75krad(Si)	12	0
				Anneal, 168 hours at +100°C	12	0
ISL72028CSEH	0.0089rad(Si)/s	<a href="#">Figure 4</a>	12	Pre-irradiation	12	
				10krad(Si)	12	0
				30krad(Si)	12	0
				50krad(Si)	12	0
				75krad(Si)	12	0
				Anneal, 168 hours at +100°C	12	0

Table 2. ISL72026CSEH, ISL72027CSEH, and ISL72028CSEH Total Dose Test Attributes Data (Continued)

Part	Rate	Bias	Sample Size	Downpoint	Bin 1 (Note 1)	Rejects
ISL72028CSEH	0.0089rad(Si)/s	Grounded	12	Pre-irradiation	12	
				10krad(Si)	12	0
				30krad(Si)	12	0
				50krad(Si)	12	0
				75krad(Si)	12	0
				Anneal, 168 hours at +100°C	12	0
<b>High Dose Rate Attributes Data</b>						
ISL72026CSEH	54.6rad(Si)/s	<a href="#">Figure 4</a>	12	Pre-irradiation	12	
				10krad(Si)	12	0
				30krad(Si)	12	0
				50krad(Si)	12	0
				75krad(Si)	12	0
				100krad(Si)	12	0
				Anneal, 168 hours at +100°C	6	0
				150krad(Si)	6	0
				Anneal, 168 hours at +100°C	6	0
ISL72026CSEH	54.6rad(Si)/s	Grounded	12	Pre-irradiation	12	
				10krad(Si)	12	0
				30krad(Si)	12	0
				50krad(Si)	12	0
				75krad(Si)	12	0
				100krad(Si)	12	0
				Anneal, 168 hours at +100°C	6	0
				150krad(Si)	6	0
				Anneal, 168 hours at +100°C	6	0
ISL72027CSEH	54.6rad(Si)/s	<a href="#">Figure 4</a>	12	Pre-irradiation	12	
				10krad(Si)	12	0
				30krad(Si)	12	0
				50krad(Si)	12	0
				75 krad(Si)	12	0
				100krad(Si)	12	0
				Anneal, 168 hours at +100°C	6	0
				150krad(Si)	6	0
				Anneal, 168 hours at +100°C	6	0

Table 2. ISL72026CSEH, ISL72027CSEH, and ISL72028CSEH Total Dose Test Attributes Data (Continued)

Part	Rate	Bias	Sample Size	Downpoint	Bin 1 (Note 1)	Rejects
ISL72027CSEH	54.6rad(Si)/s	Grounded	12	Pre-irradiation	12	
				10krad(Si)	12	0
				30krad(Si)	12	0
				50krad(Si)	12	0
				75krad(Si)	12	0
				100krad(Si)	12	0
				Anneal, 168 hours at +100°C	6	0
				150krad(Si)	6	0
				Anneal, 168 hours at +100°C	6	0
ISL72028CSEH	54.6rad(Si)/s	<a href="#">Figure 4</a>	12	Pre-irradiation	12	
				10krad(Si)	12	0
				30krad(Si)	12	0
				50krad(Si)	12	0
				75krad(Si)	12	0
				100krad(Si)	12	0
				Anneal, 168 hours at +100°C	6	0
				150krad(Si)	6	0
				Anneal, 168 hours at +100°C	6	0
ISL72028CSEH	54.6rad(Si)/s	Grounded	12	Pre-irradiation	12	
				10krad(Si)	12	0
				30krad(Si)	12	0
				50krad(Si)	12	0
				75krad(Si)	12	0
				100krad(Si)	12	0
				Anneal, 168 hours at +100°C	6	0
				150krad(Si)	6	0
				Anneal, 168 hours at +100°C	6	0

## Notes:

1. Bin 1 indicates a device that passes all pre-irradiation specification limits.



### 3. Variables Data

The plots in [Figures 5](#) through [70](#) show data at all downpoints for both low and high dose rates. The plots show the average of key parameters as a function of total dose for each of the two irradiation conditions, Biased (B\_) and Unbiased (U\_), for all three variants (\_26, \_27, \_28), if available. PA\_L on the graphs stands for the Post-Anneal downpoint for the low dose rate samples; PA\_H1 and PA\_H2 indicate the Post-Anneal downpoints for the high dose rate samples after 100krad(Si) and 150krad(Si), respectively. For example, the legend Avg\_26 (B\_H1) indicates the average, biased, HDR response for the ISL72026CSEH to 100krad(Si), plus anneal. Most data shown was taken at a supply voltage of 3.0V, unless it was determined that the 3.6V data was worst case. In general, though, the 3.6V supply data showed similar stability and is not plotted. The figure sequence and the symbols of the reported parameters are consistent with those used in the SMD. All parameters showed excellent stability over irradiation. See [“Conclusion” on page 43](#) for more information.

Although most of the plots show all three variants, the following figures show the response of only one or two variants, according to their functionality.

- [Figures 20](#) and [21](#): ISL72026CSEH and ISL72027CSEH, input threshold voltage in Listen mode.
- [Figure 22](#): ISL72026CSEH and ISL72027CSEH, input hysteresis voltage in Listen mode.
- [Figure 36](#): ISL72026CSEH and ISL72027CSEH, supply current in Listen mode.
- [Figure 37](#): ISL72028CSEH, supply current in low power Shutdown mode.
- [Figure 42](#): ISL72027CSEH and ISL72028CSEH, VREF cold sparing leakage current.
- [Figures 63](#) and [64](#): ISL72026CSEH, loopback delay, input to receiver output.
- [Figures 65](#) and [66](#): ISL72027CSEH and ISL72028CSEH, VREF pin voltage, 5 $\mu$ A sourcing and sinking.
- [Figures 67](#) and [68](#): ISL72027CSEH and ISL72028CSEH, VREF pin voltage, 50 $\mu$ A sourcing and sinking.

#### 3.1 Variables Data Plots

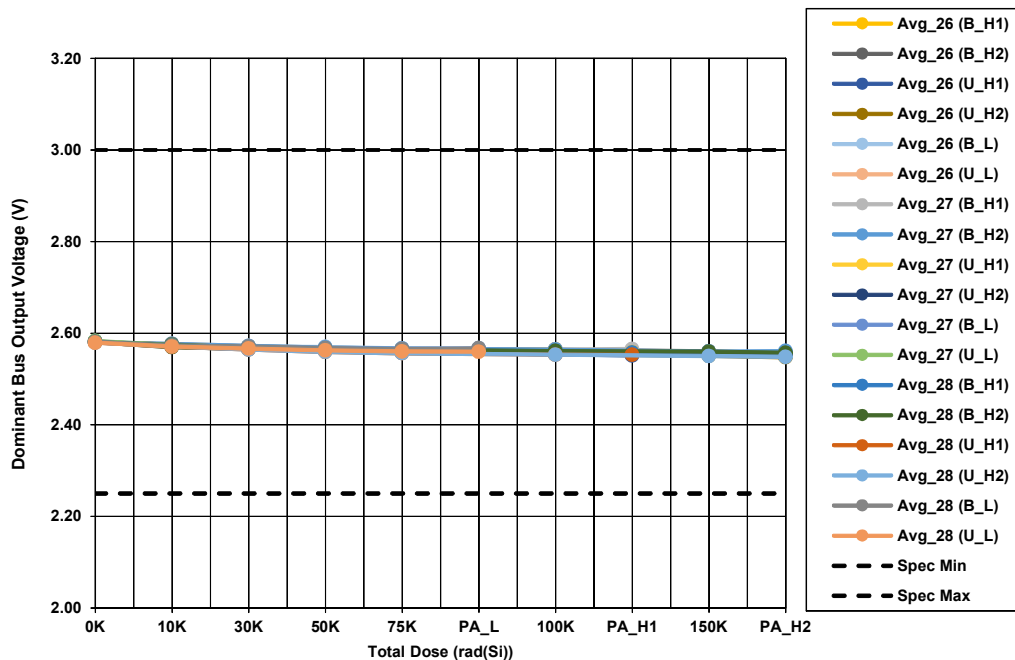

Figure 5. ISL72026CSEH, ISL72027CSEH, and ISL72028CSEH transmitter dominant bus output voltage ( $V_{O(DOM)}$ ) for 3.0V supply,  $D = 0V$ ,  $RS = 0V$ , and CAN HIGH as a function of low and high dose rate irradiation for the biased (B\_ per [Figure 4](#)) and unbiased (U\_ all pins grounded) cases. The post-irradiation SMD limits are 2.25V to 3.0V.

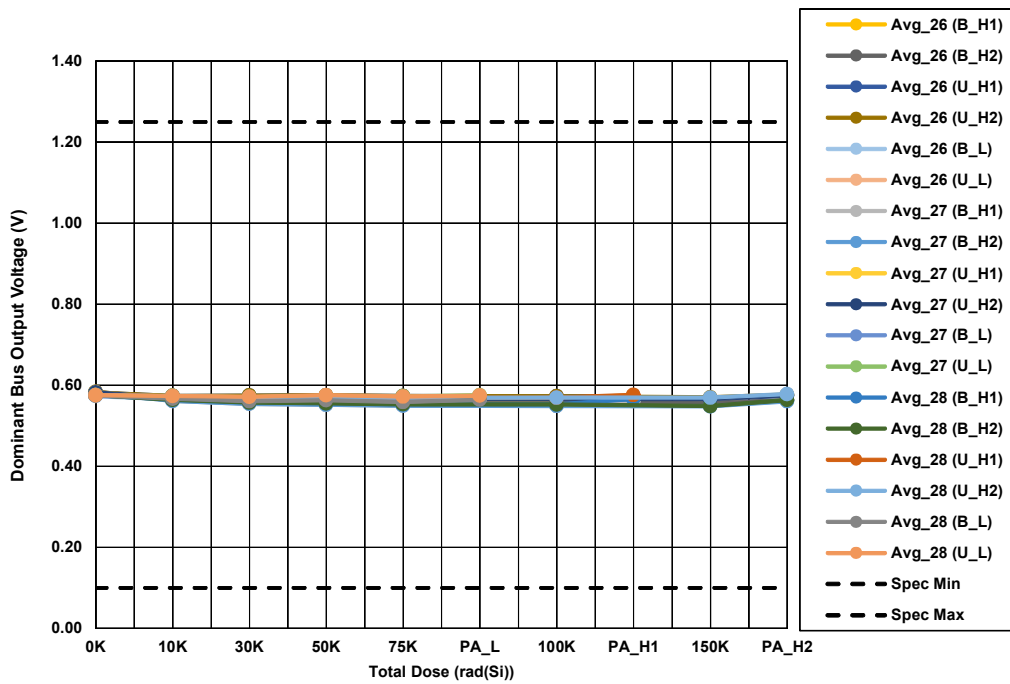

Figure 6. ISL72026CSEH, ISL72027CSEH, and ISL72028CSEH transmitter dominant bus output voltage ( $V_{O(DOM)}$ ) for 3.0V supply,  $D = 0V$ ,  $RS = 0V$ , and CAN LOW as a function of low and high dose rate irradiation for the biased (B\_ per Figure 4) and unbiased (U\_ all pins grounded) cases. The post-irradiation SMD limits are 0.1V to 1.25V.

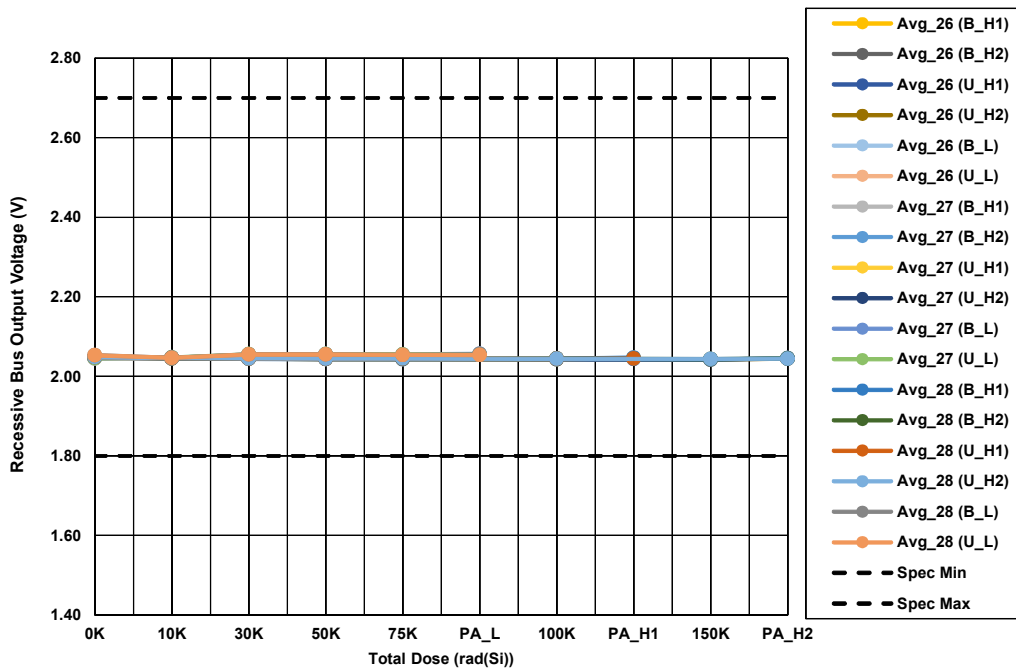

Figure 7. ISL72026CSEH, ISL72027CSEH, and ISL72028CSEH transmitter recessive bus output voltage ( $V_{O(REC)}$ ) for 3.0V supply,  $D = 0V$ ,  $RS = 0V$  and CAN HIGH as a function of low and high dose rate irradiation for the biased (B\_ - per Figure 4) and unbiased (U\_ - all pins grounded) cases. The post-irradiation SMD limits are 1.8V to 2.7V.

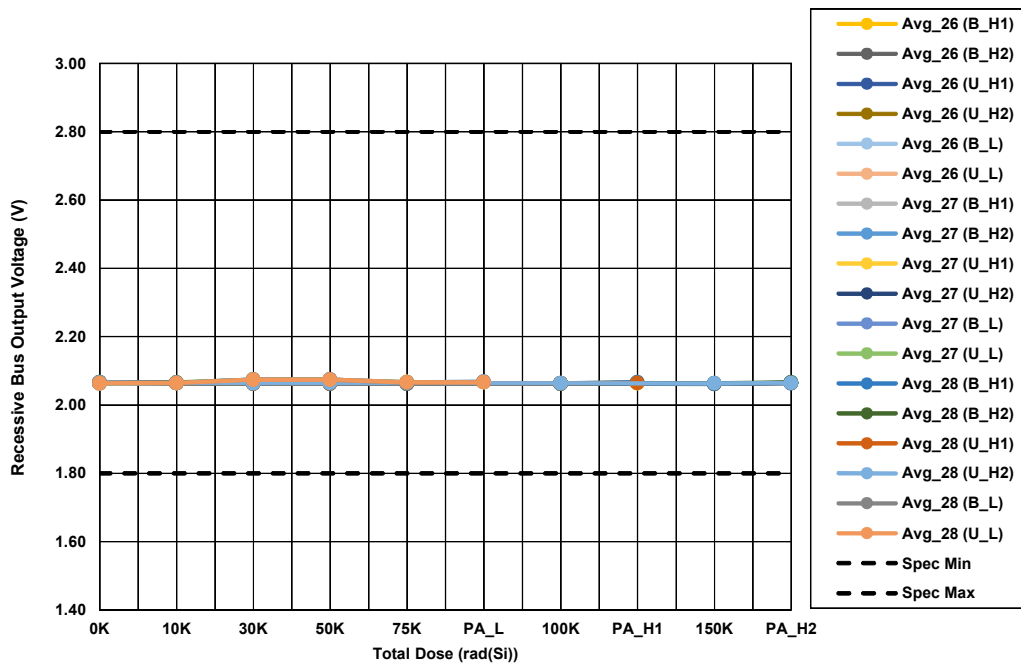

Figure 8. ISL72026CSEH, ISL72027CSEH, and ISL72028CSEH transmitter recessive bus output voltage ( $V_{O(REC)}$ ) for 3.0V supply,  $D = 0V$ ,  $RS = 0V$  and CAN LOW as a function of low and high dose rate irradiation for the biased (B\_ - per Figure 4) and unbiased (U\_ - all pins grounded) cases. The post-irradiation SMD limits are 1.8V to 2.8V.

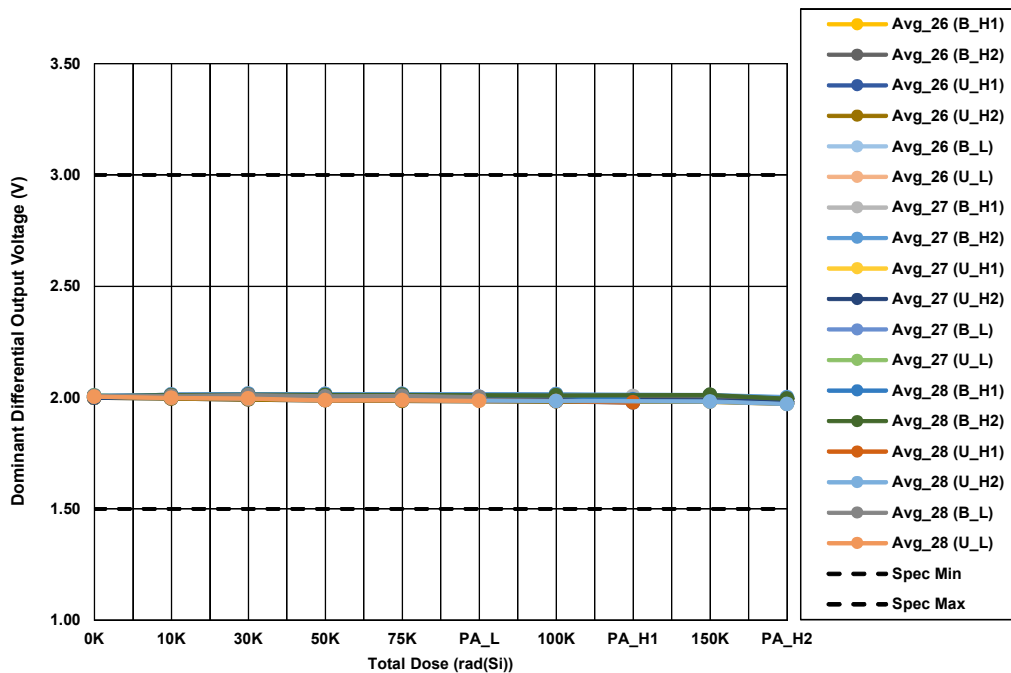

Figure 9. ISL72026CSEH, ISL72027CSEH, and ISL72028CSEH transmitter dominant output differential voltage ( $V_{OD(DOM)}$ ) for 3.0V supply,  $D = 0V$  and  $RS = 0V$  as a function of low and high dose rate irradiation for the biased (B\_ - per Figure 4) and unbiased (U\_ - all pins grounded) cases. The post-irradiation SMD limits are 1.5V to 3.0V.

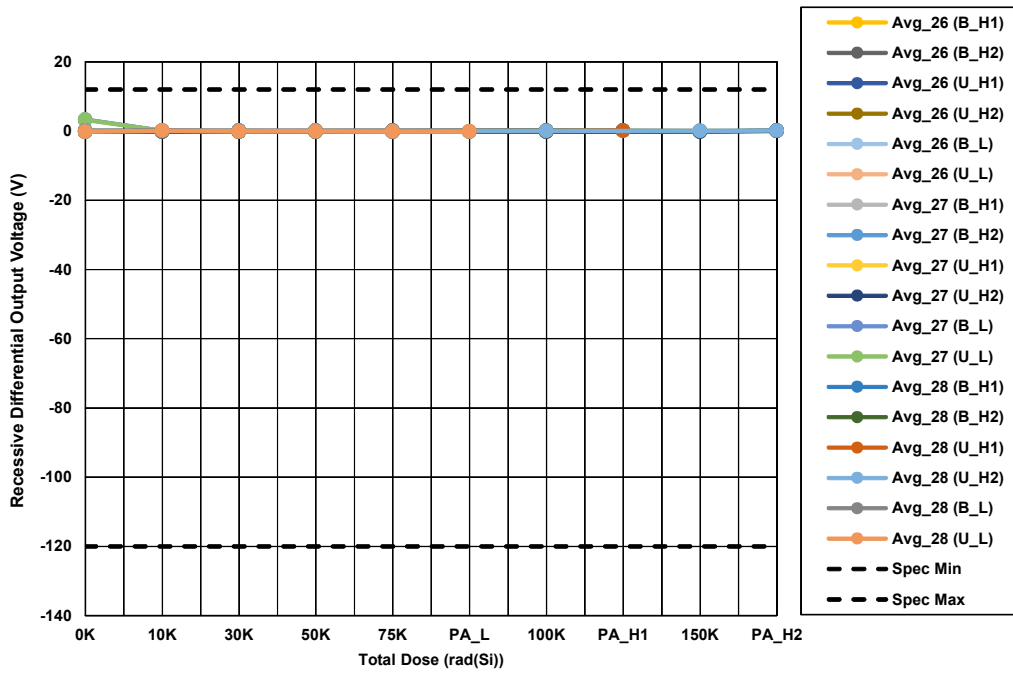

Figure 10. ISL72026CSEH, ISL72027CSEH, and ISL72028CSEH transmitter recessive output differential voltage ( $V_{OD(REC)}$ ) for 3.0V supply,  $D = 0V$ ,  $RS = 0V$  as a function of low and high dose rate irradiation for the biased (B\_ - per Figure 4) and unbiased (U\_ - all pins grounded) cases. The post-irradiation SMD limits are -120mV to 12mV.

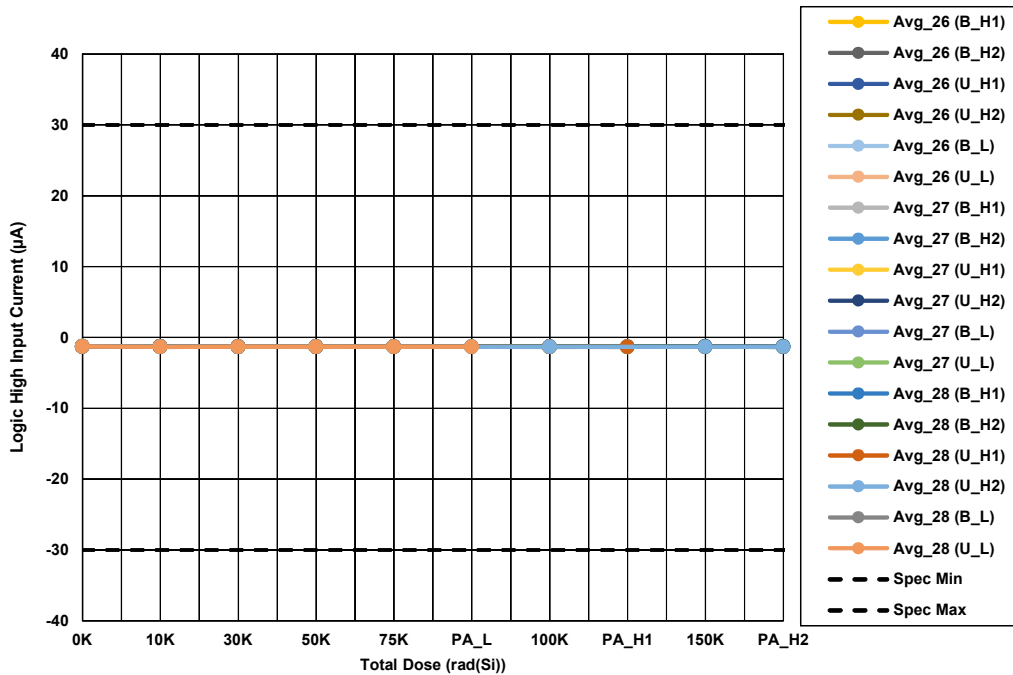

Figure 11. ISL72026CSEH, ISL72027CSEH, and ISL72028CSEH transmitter D input HIGH ( $D = 2.0V$ ) input current ( $I_{IH}$ ) for 3.0V supply, as a function of low and high dose rate irradiation for the biased (B\_ - per Figure 4) and unbiased (U\_ - all pins grounded) cases. The post-irradiation SMD limits are -30µA to +30µA.

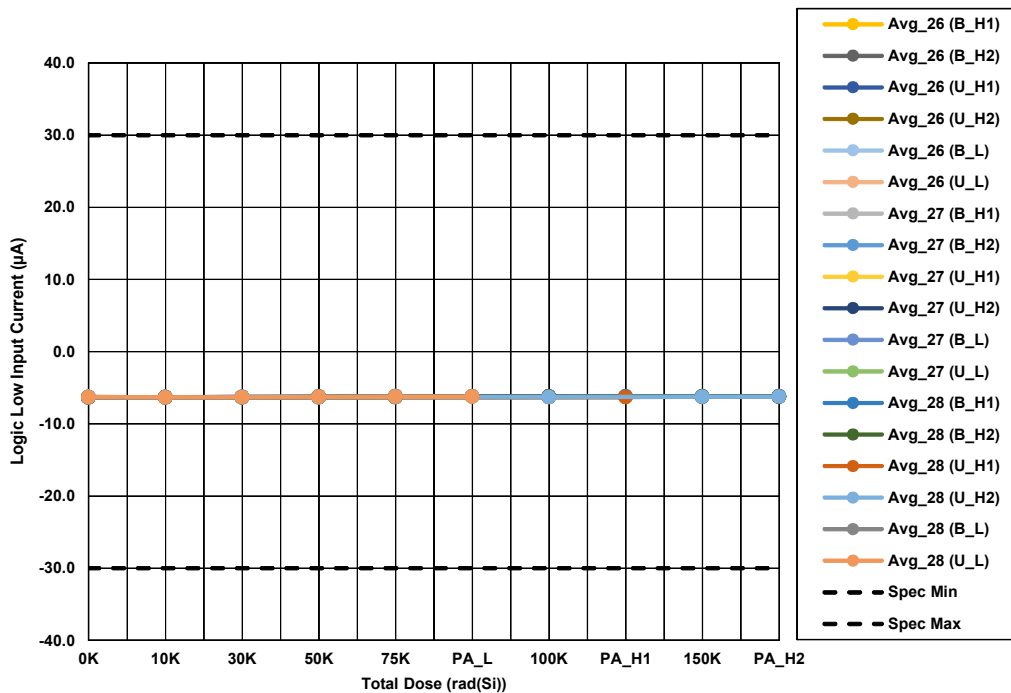

Figure 12. ISL72026CSEH, ISL72027CSEH, and ISL72028CSEH transmitter D input LOW ( $I_{IL}$ ) for 3.0V supply, as a function of low and high dose rate irradiation for the biased (B\_ - per [Figure 4](#)) and unbiased (U\_ - all pins grounded) cases. The post-irradiation SMD limits are  $-30\mu\text{A}$  to  $+30\mu\text{A}$ .

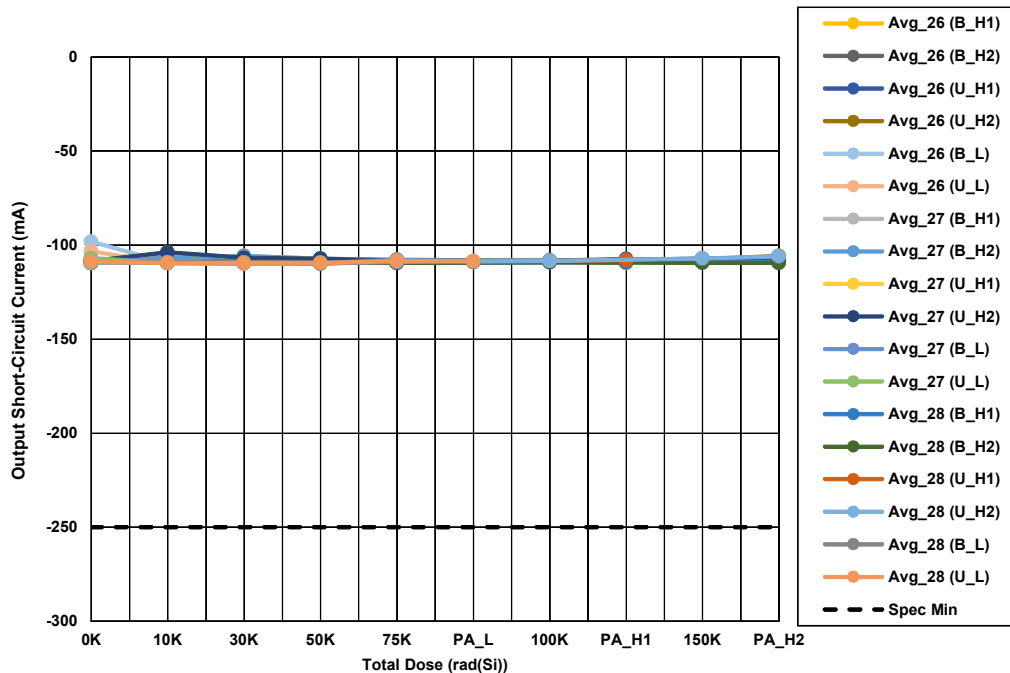

Figure 13. ISL72026CSEH, ISL72027CSEH, and ISL72028CSEH transmitter output short-circuit current ( $I_{OSC}$ ) for 3.0V supply,  $V_{CANH} = -7\text{V}$  and  $V_{CANL} = \text{open}$ , as a function of low and high dose rate irradiation for the biased (B\_ - per [Figure 4](#)) and unbiased (U\_ - all pins grounded) cases. The post-irradiation SMD limit is  $-250\text{mA}$  minimum.

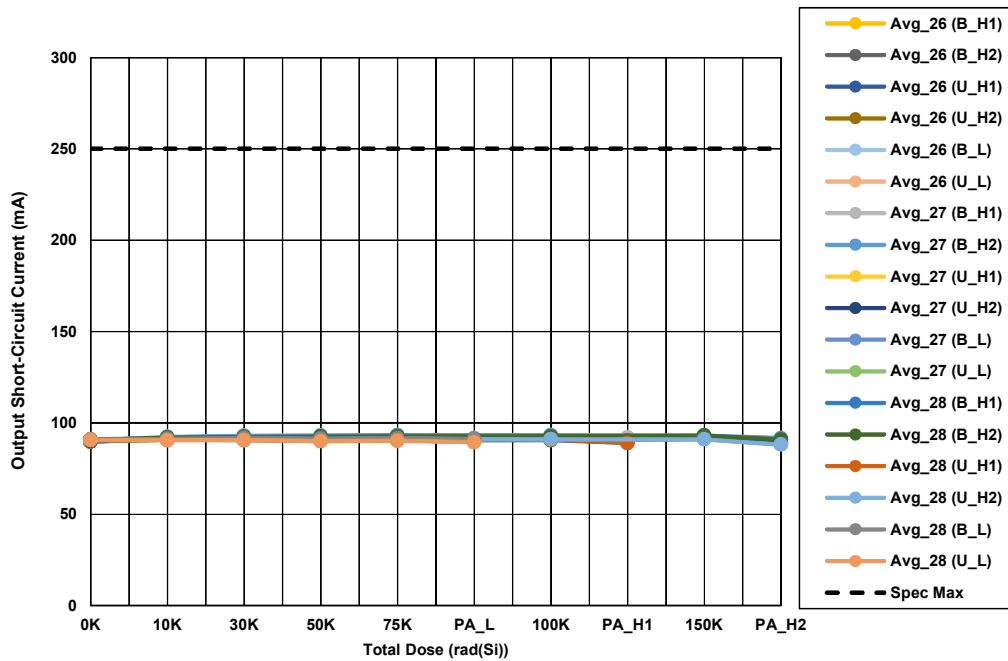

Figure 14. ISL72026CSEH and ISL72027CSEH transmitter output short-circuit current ( $I_{O_{SC}}$ ) for 3.0V supply,  $V_{CANL} = 12V$  and  $V_{CANH} = open$ , as a function of low and high dose rate irradiation for the biased (B\_ - per [Figure 4](#)) and unbiased (U\_ - all pins grounded) cases. The post-irradiation SMD limit is 250mA maximum.

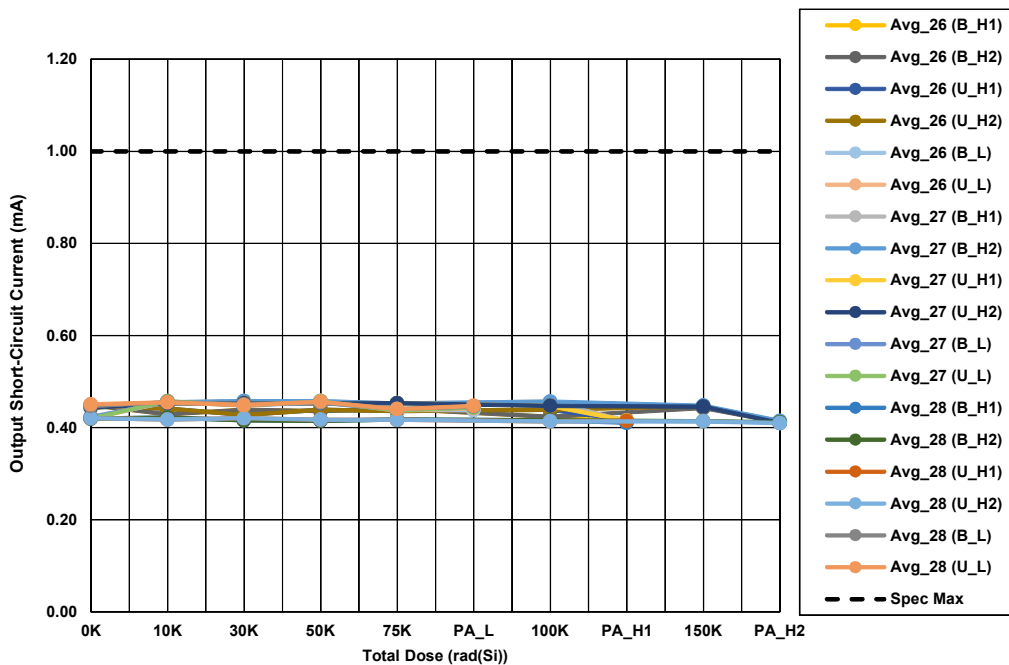

Figure 15. ISL72026CSEH and ISL72027CSEH transmitter output short-circuit current ( $I_{O_{SC}}$ ) for 3.0V supply,  $V_{CANH} = 12V$  and  $V_{CANL} = open$ , as a function of low and high dose rate irradiation for the biased (B\_ - per [Figure 4](#)) and unbiased (U\_ - all pins grounded) cases. The post-irradiation SMD limit is 1mA maximum.

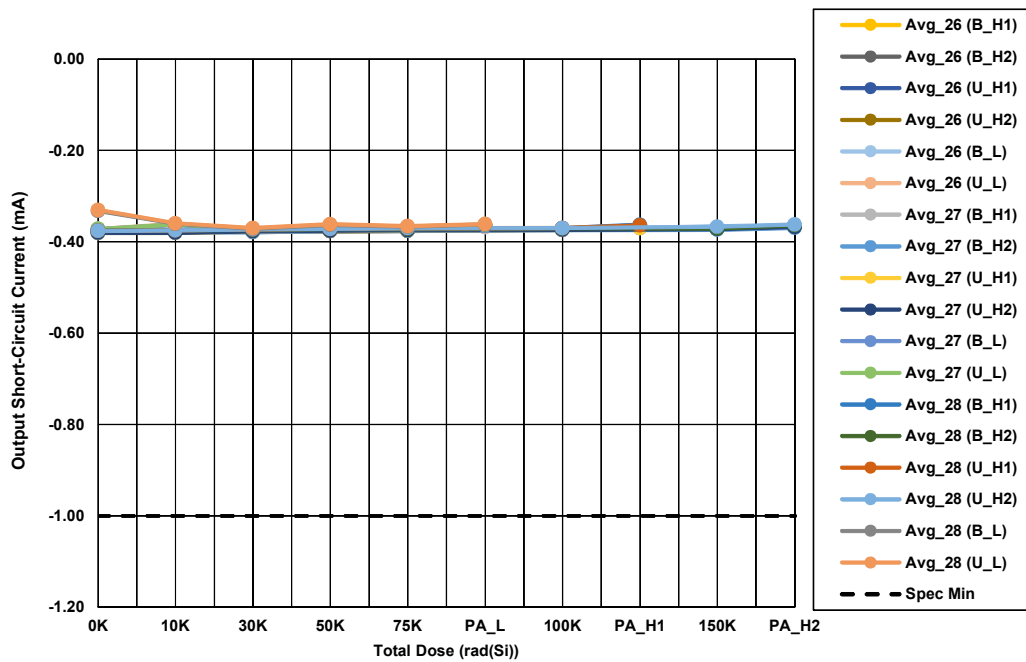

Figure 16. ISL72026CSEH, ISL72027CSEH, and ISL72028CSEH transmitter output short-circuit current ( $I_{OSC}$ ) for 3.0V supply,  $V_{CANL} = -7V$  and  $V_{CANH} = open$ , as a function of low and high dose rate irradiation for the biased (B\_ - per Figure 4) and unbiased (U\_ - all pins grounded) cases. The post-irradiation SMD limit is -1mA minimum.

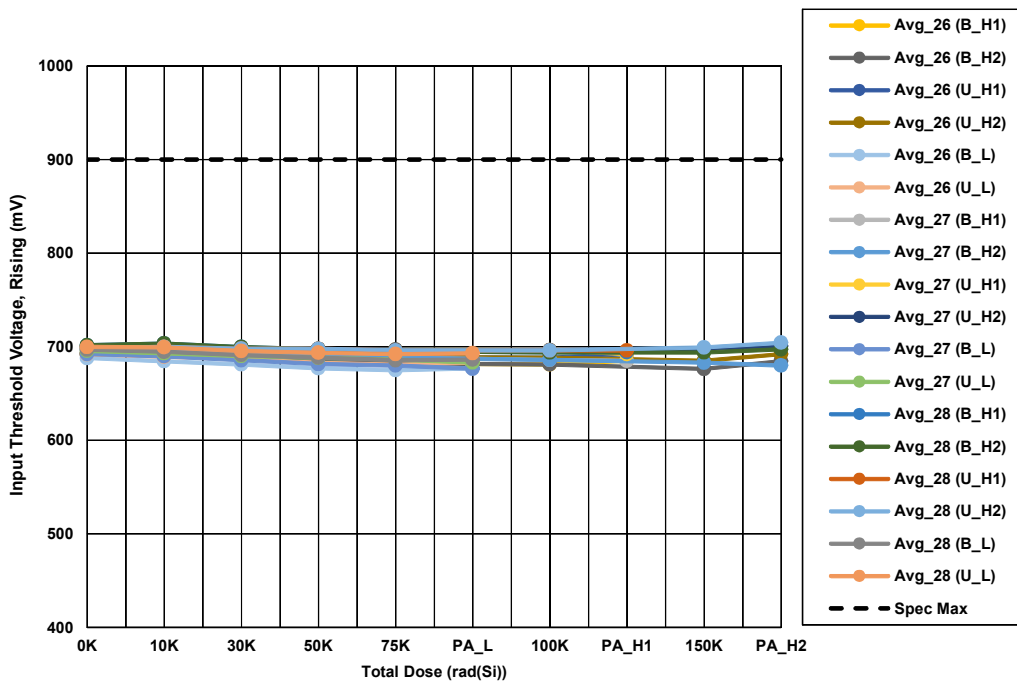

Figure 17. ISL72026CSEH, ISL72027CSEH, and ISL72028CSEH receiver rising (recessive to dominant) input threshold voltage ( $V_{THR}$ ) for 3.0V supply,  $R_S = 0V$ , as a function of low and high dose rate irradiation for the biased (B\_ - per Figure 4) and unbiased (U\_ - all pins grounded) cases. The post-irradiation SMD limit is 900mV maximum.

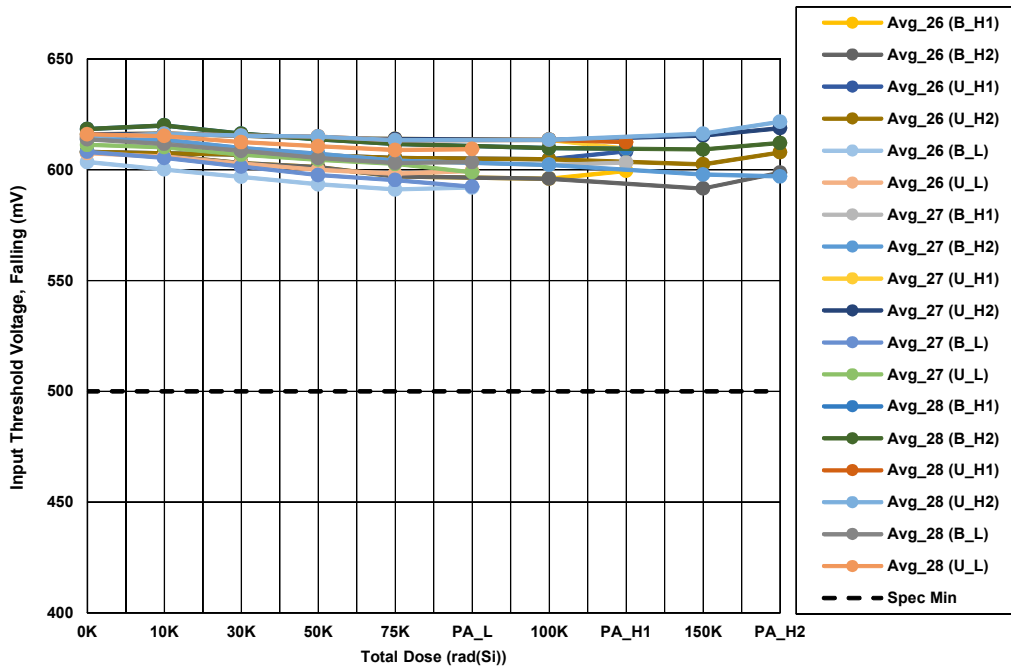

Figure 18. ISL72026CSEH, ISL72027CSEH, and ISL72028CSEH receiver falling (dominant to recessive) input threshold voltage ( $V_{THF}$ ) for 3.0V supply,  $R_S = 0V$ , as a function of low and high dose rate irradiation for the biased (B\_ - per Figure 4) and unbiased (U\_ - all pins grounded) cases. The post-irradiation SMD limit is 500mV minimum.

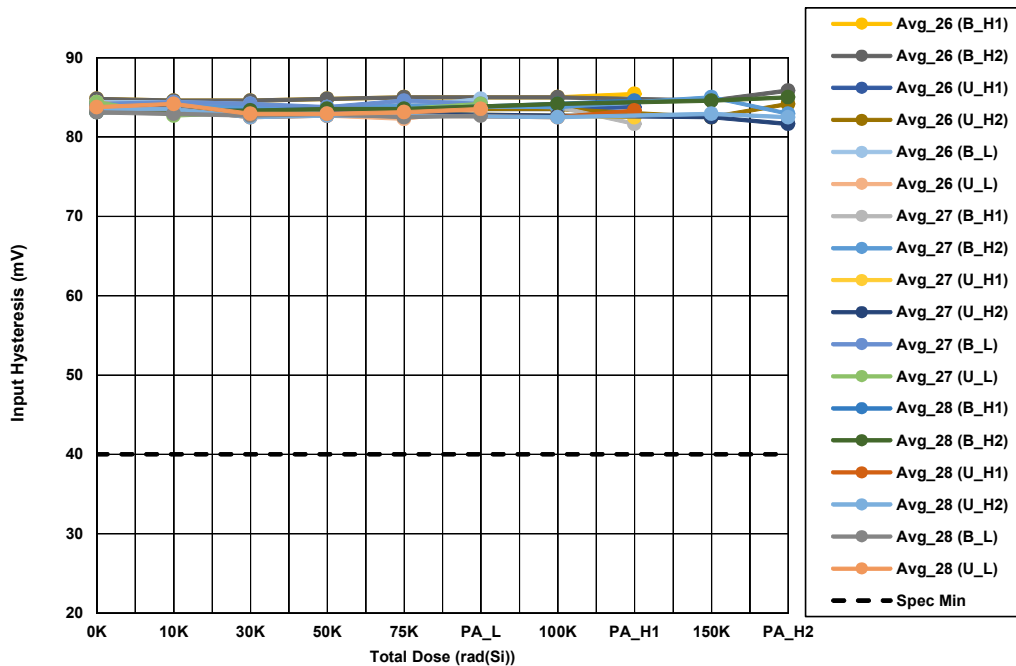

Figure 19. ISL72026CSEH, ISL72027CSEH, and ISL72028CSEH receiver input hysteresis ( $V_{HYS} = V_{THR} - V_{THF}$ ) for 3.0V supply,  $R_S = 0V$ , as a function of low and high dose rate irradiation for the biased (B\_ - per Figure 4) and unbiased (U\_ - all pins grounded) cases. The post-irradiation SMD limit is 40mV minimum.



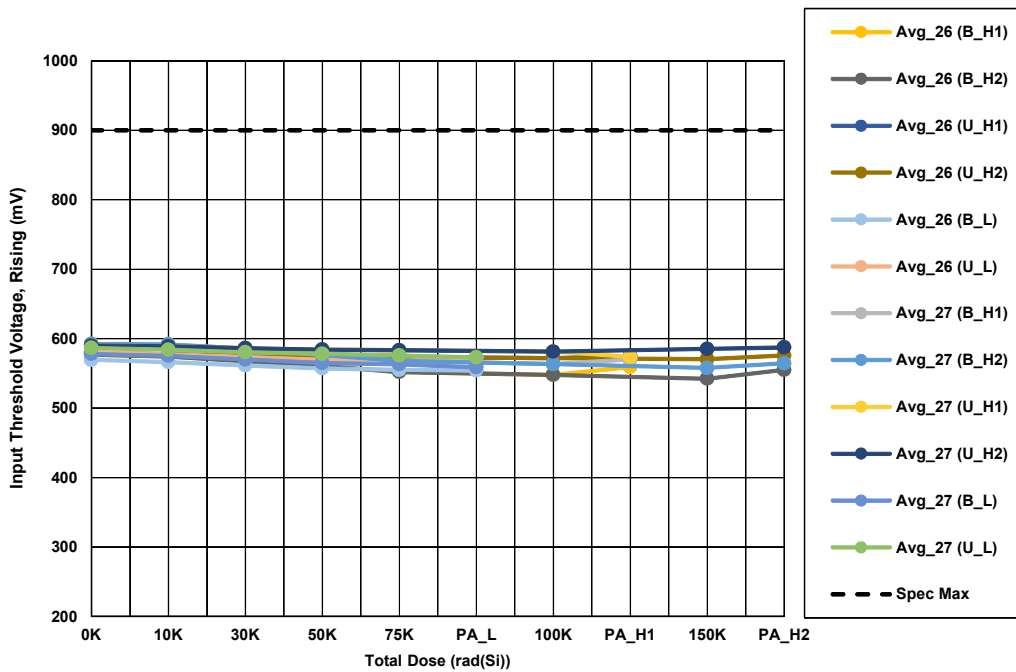

Figure 20. ISL72026CSEH and ISL72027CSEH receiver listen mode rising (recessive to dominant) input threshold voltage ( $V_{THRLM}$ ) for 3.0V supply,  $R_S = V_{CC}$ , as a function of low and high dose rate irradiation for the biased (B\_ - per Figure 4) and unbiased (U\_ - all pins grounded) cases. The post-irradiation SMD limit is 900mV maximum.

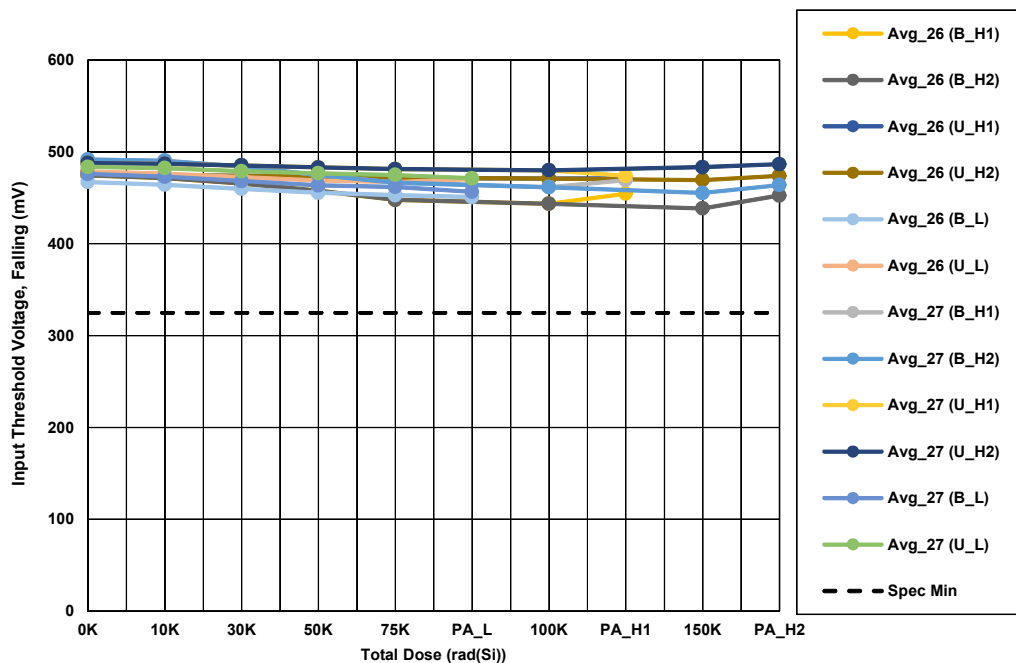

Figure 21. ISL72026CSEH and ISL72027CSEH receiver listen mode falling (dominant to recessive) input threshold voltage ( $V_{THFLM}$ ) for 3.0V supply,  $R_S = V_{CC}$ , as a function of low and high dose rate irradiation for the biased (B\_ - per Figure 4) and unbiased (U\_ - all pins grounded) cases. The post-irradiation SMD limit is 325mV minimum.

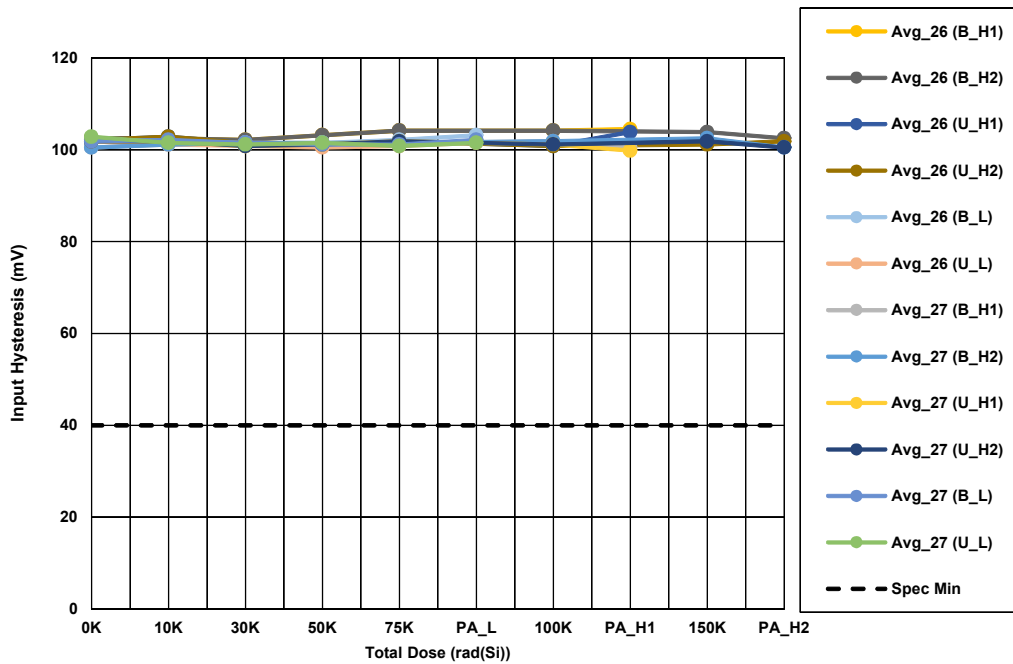

Figure 22. ISL72026CSEH and ISL72027CSEH receiver listen mode input hysteresis ( $V_{HYSLM} = V_{THRLM} - V_{THFLM}$ ) for 3.0V supply,  $R_S = V_{CC}$ , as a function of low and high dose rate irradiation for the biased (B\_ - per Figure 4) and unbiased (U\_ - all pins grounded) cases. The post-irradiation SMD limit is 40mV minimum.

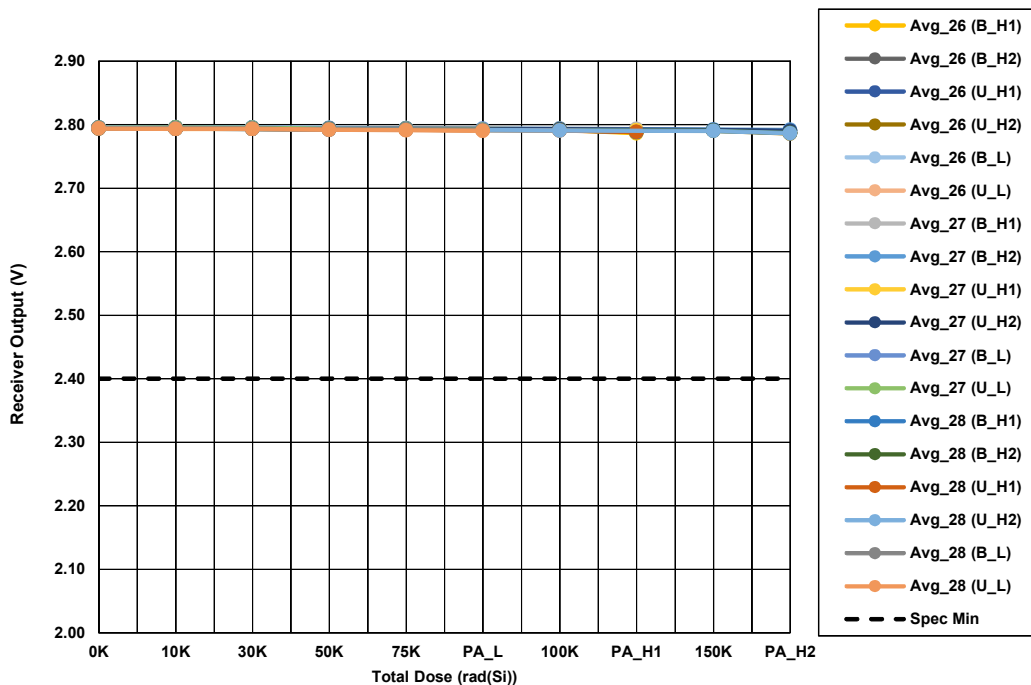

Figure 23. ISL72026CSEH, ISL72027CSEH, and ISL72028CSEH receiver output HIGH voltage ( $V_{OH}$ ) for 3.0V supply,  $I_{OUT} = -4mA$ , as a function of low and high dose rate irradiation for the biased (B\_ - per Figure 4) and unbiased (U\_ - all pins grounded) cases. The post-irradiation SMD limit is 2.4V minimum.

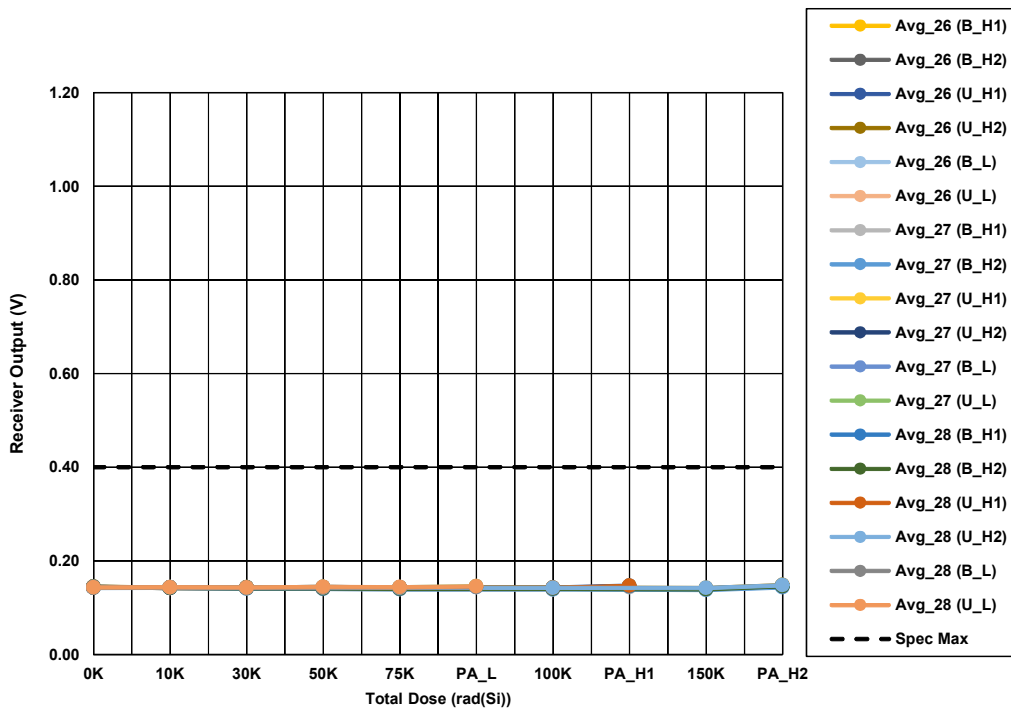

Figure 24. ISL72026CSEH, ISL72027CSEH, and ISL72028CSEH receiver output LOW voltage ( $V_{OL}$ ) for 3.0V supply,  $I_{OUT} = 4mA$ , as a function of low and high dose rate irradiation for the biased ( $B_-$  - per [Figure 4](#)) and unbiased ( $U_-$  - all pins grounded) cases. The post-irradiation SMD limit is 0.4V maximum.

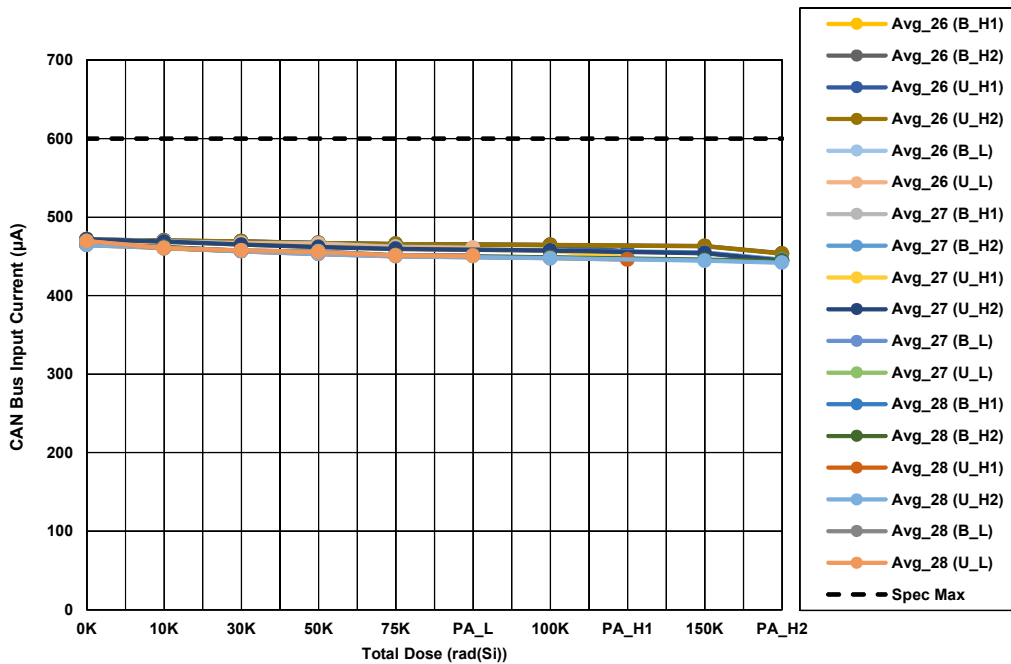

Figure 25. ISL72026CSEH, ISL72027CSEH, and ISL72028CSEH receiver CAN bus input current ( $I_{CAN}$ ) for 3.0V supply,  $CAN_H = 12V$ ,  $D = 3V$ ,  $LBK = RS = 0V$ , as a function of low and high dose rate irradiation for the biased ( $B_-$  - per [Figure 4](#)) and unbiased ( $U_-$  - all pins grounded) cases. The post-irradiation SMD limit is 600µA maximum.

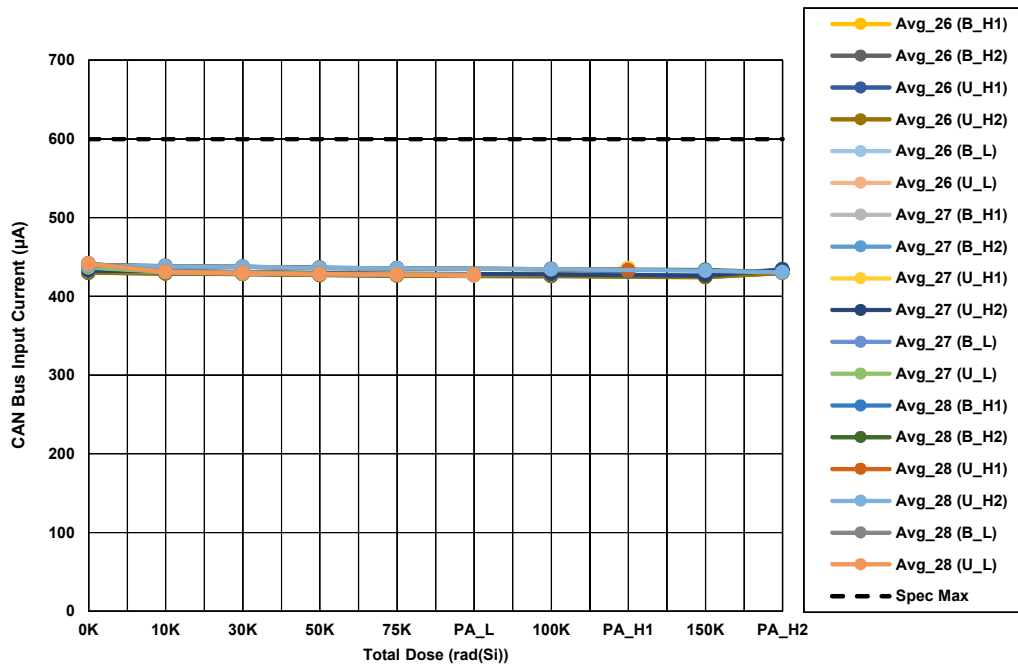

Figure 26. ISL72026CSEH, ISL72027CSEH, and ISL72028CSEH receiver CAN bus input current ( $I_{CAN}$ ) for 3.0V supply, CANL = 12V, D = 3V, LBK = RS = 0V, as a function of low and high dose rate irradiation for the biased (B\_ - per Figure 4) and unbiased (U\_ - all pins grounded) cases. The post-irradiation SMD limit is 600µA maximum.

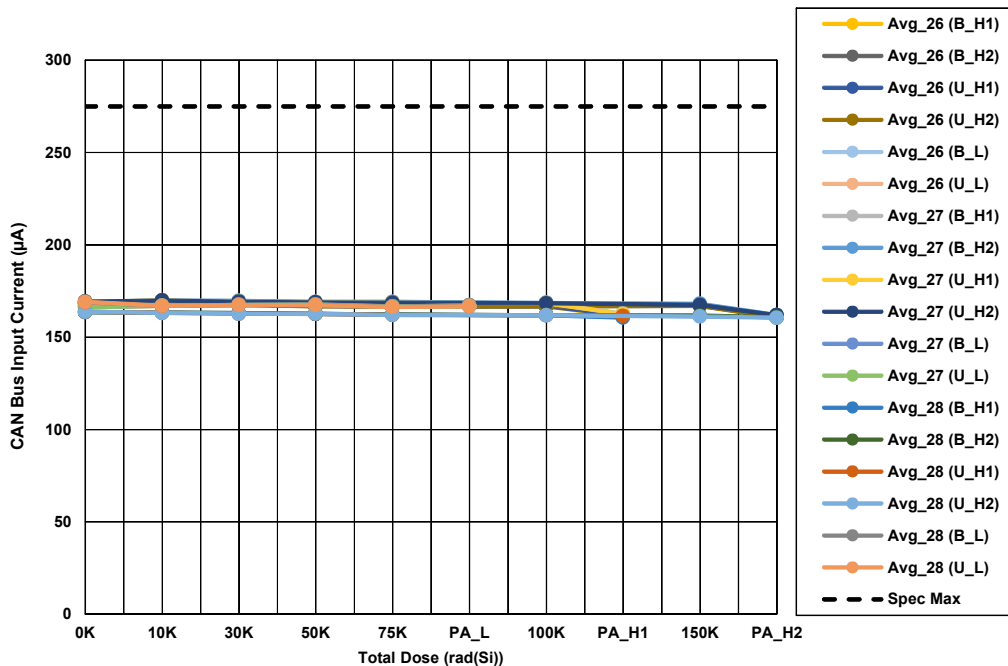

Figure 27. ISL72026CSEH, ISL72027CSEH, and ISL72028CSEH receiver CAN bus input current ( $I_{CAN}$ ), CANH = 12V, D = 3V, VCC = RS = 0V, as a function of low and high dose rate irradiation for the biased (B\_ - per Figure 4) and unbiased (U\_ - all pins grounded) cases. The post-irradiation SMD limit is 275µA maximum.

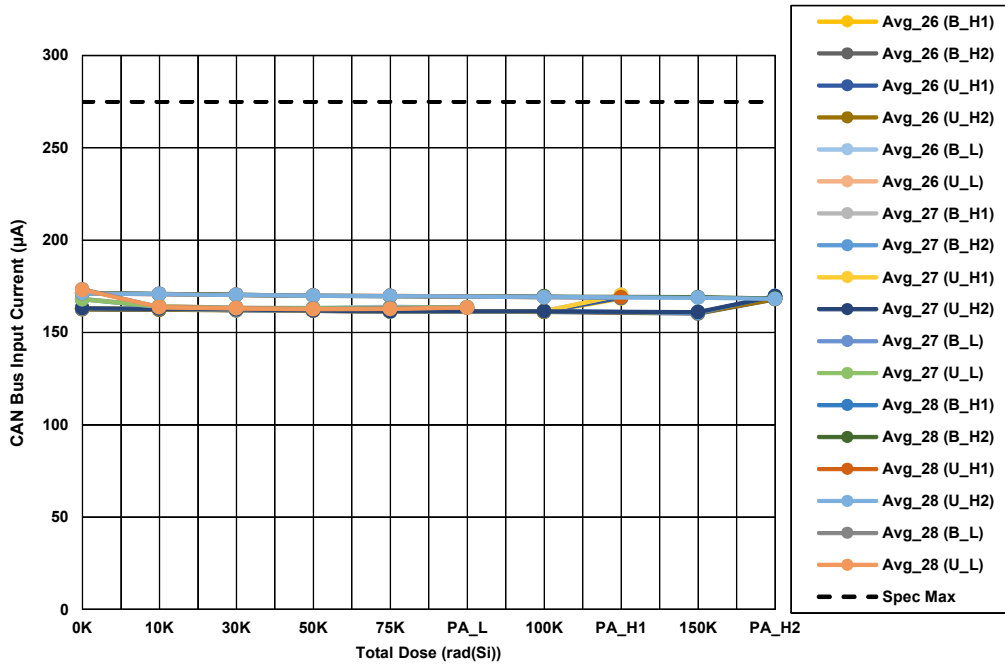

Figure 28. ISL72026CSEH, ISL72027CSEH, and ISL72028CSEH receiver CAN bus input current ( $I_{CAN}$ ), CANL = 12V, D = 3V, VCC = RS = 0V, as a function of low and high dose rate irradiation for the biased (B\_ - per Figure 4) and unbiased (U\_ - all pins grounded) cases. The post-irradiation SMD limit is 275µA maximum.

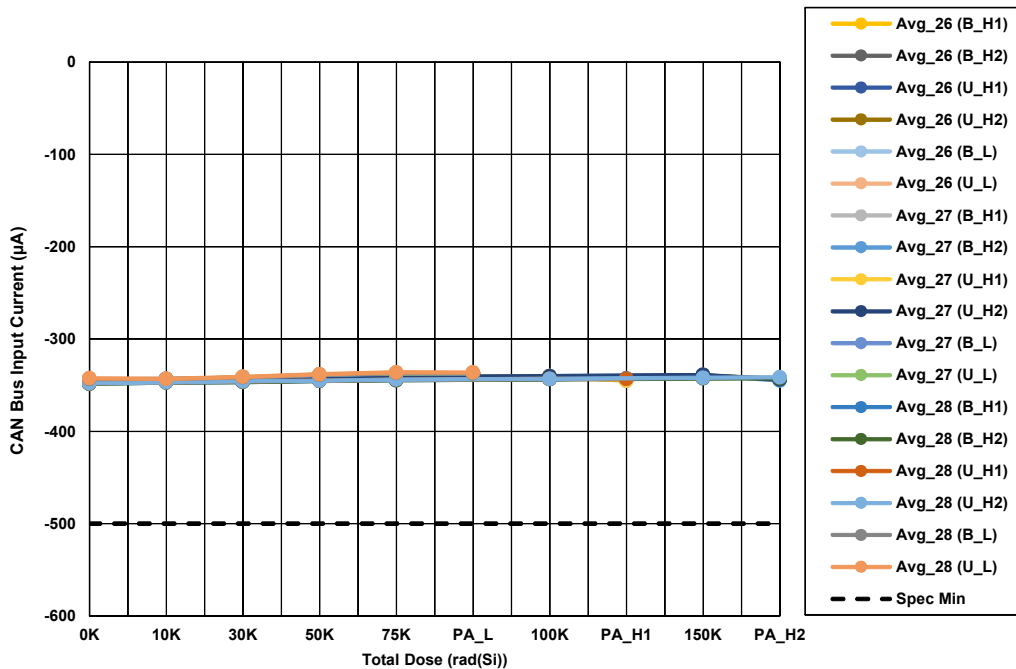

Figure 29. ISL72026CSEH, ISL72027CSEH, and ISL72028CSEH receiver CAN bus input current ( $I_{CAN}$ ) for a 3.0V supply, CANH = -7V, D = 3V, LBK = RS = 0V, as a function of low and high dose rate irradiation for the biased (B\_ - per Figure 4) and unbiased (U\_ - all pins grounded) cases. The post-irradiation SMD limit is -500µA minimum.

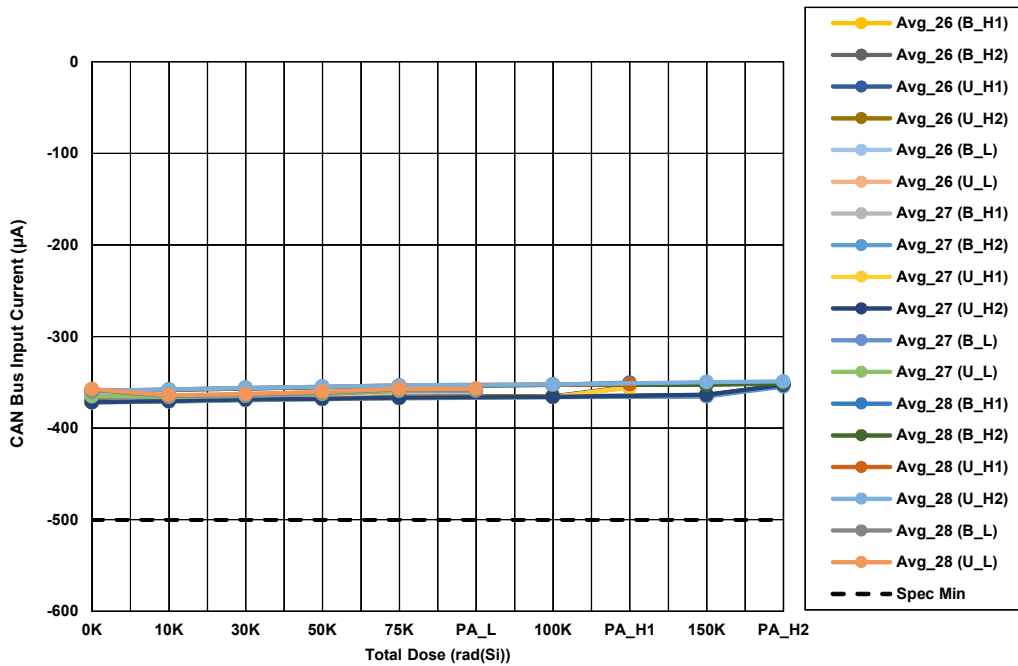

Figure 30. ISL72026CSEH, ISL72027CSEH, and ISL72028CSEH receiver CAN bus input current ( $I_{CAN}$ ) for a 3.0V supply, CANL = -7V, D = 3V, LBK = RS = 0V, as a function of low and high dose rate irradiation for the biased (B\_ - per Figure 4) and unbiased (U\_ - all pins grounded) cases. The post-irradiation SMD limit is -500µA minimum.

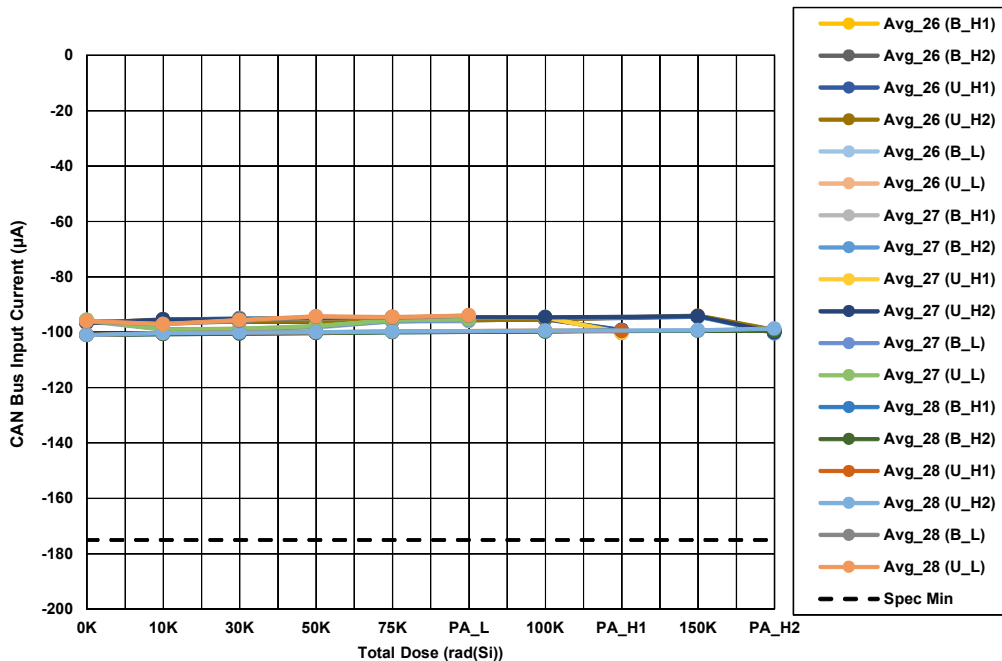

Figure 31. ISL72026CSEH, ISL72027CSEH, and ISL72028CSEH receiver CAN bus input current ( $I_{CAN}$ ), CANH = -7V, D = 3V,  $V_{CC}$  = RS = 0V, as a function of low and high dose rate irradiation for the biased (B\_ - per Figure 4) and unbiased (U\_ - all pins grounded) cases. The post-irradiation SMD limit is -175µA minimum.

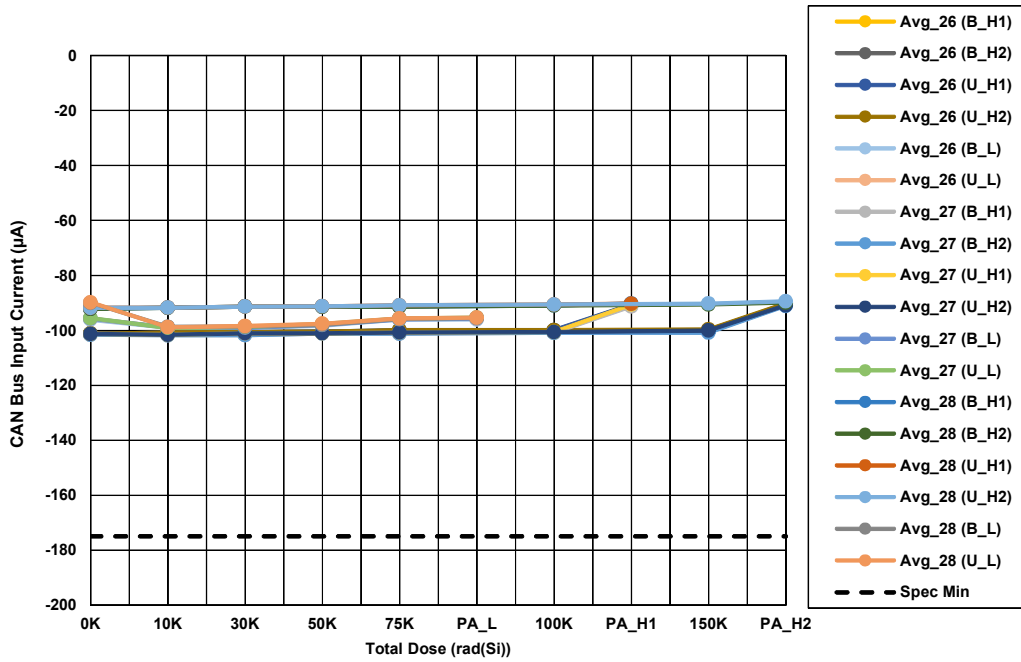

Figure 32. ISL72026CSEH, ISL72027CSEH, and ISL72028CSEH receiver CAN bus input current ( $I_{CAN}$ ), CANL = -7V, D = 3V,  $V_{CC}$  = RS = 0V, as a function of low and high dose rate irradiation for the biased (B\_ - per Figure 4) and unbiased (U\_ - all pins grounded) cases. The post-irradiation SMD limit is -175µA minimum.

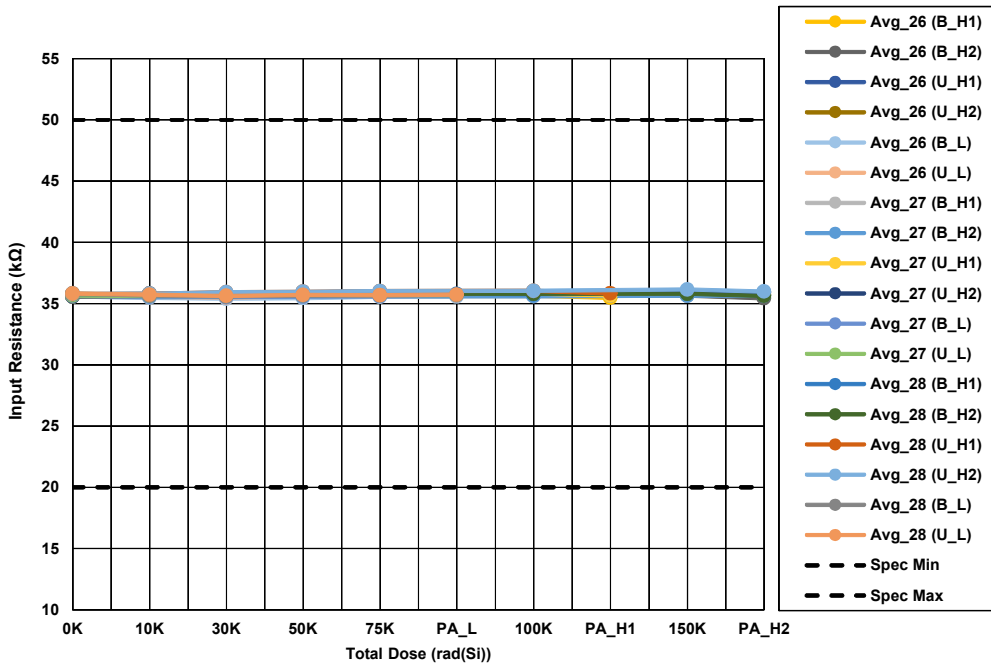

Figure 33. ISL72026CSEH, ISL72027CSEH, and ISL72028CSEH receiver input resistance ( $R_{IN}$ ), for a 3.0V supply, CANH, input to ground, D = 3V, LBK = RS = 0V, as a function of low and high dose rate irradiation for the biased (B\_ - per Figure 4) and unbiased (U\_ - all pins grounded) cases. The post-irradiation SMD limits are 20kΩ to 50kΩ.

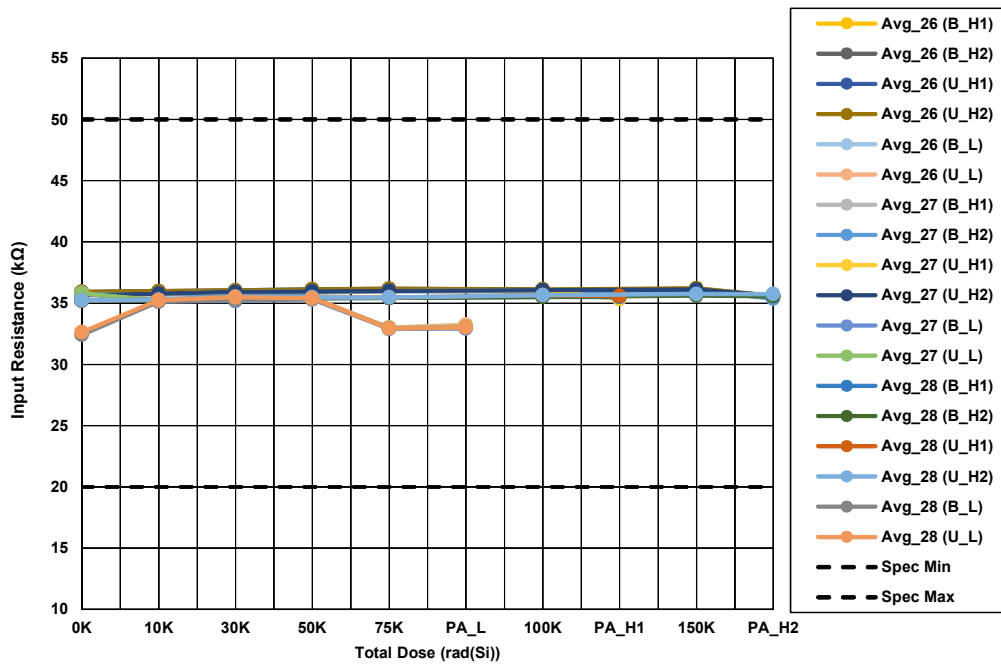

Figure 34. ISL72026CSEH, ISL72027CSEH, and ISL72028CSEH receiver input resistance ( $R_{IN}$ ), for a 3.0V supply, CANL, input to ground,  $D = 3V$ ,  $LBK = RS = 0V$ , as a function of low and high dose rate irradiation for the biased ( $B_{-}$  - per Figure 4) and unbiased ( $U_{-}$  - all pins grounded) cases. The post-irradiation SMD limits are 20kΩ to 50kΩ.

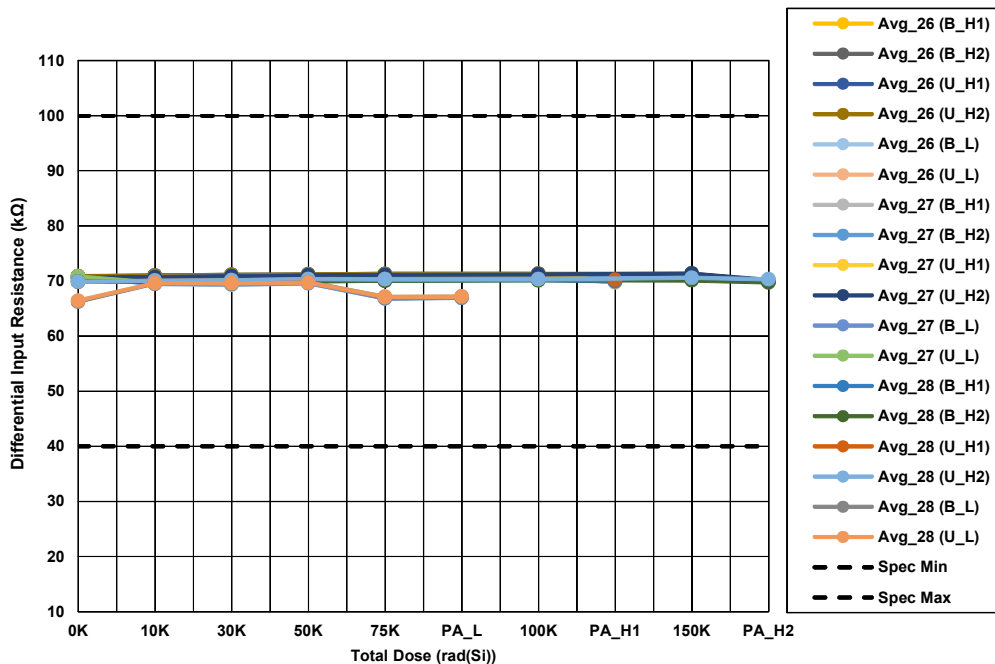

Figure 35. ISL72026CSEH, ISL72027CSEH, and ISL72028CSEH receiver differential input resistance ( $R_{IND}$ ), for a 3.0V supply, input to input,  $D = 3V$ ,  $LBK = RS = 0V$ , as a function of low and high dose rate irradiation for the biased ( $B_{-}$  - per Figure 4) and unbiased ( $U_{-}$  - all pins grounded) cases. The post-irradiation SMD limits are 40kΩ to 100kΩ.



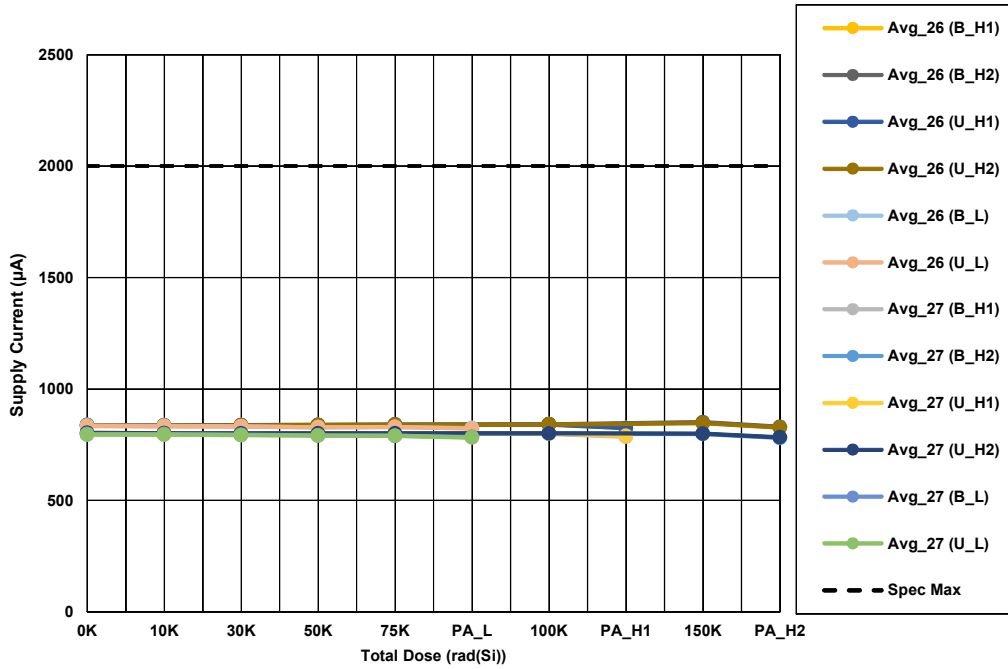

Figure 36. ISL72026CSEH and ISL72027CSEH supply current in Listen mode ( $I_{CC(L)}$ ), at 3.0V supply,  $RS = D = V_{CC}$ , as a function of low and high dose rate irradiation for the biased (B\_ - per Figure 4) and unbiased (U\_ - all pins grounded) cases. The post-irradiation SMD limit is 2mA maximum.

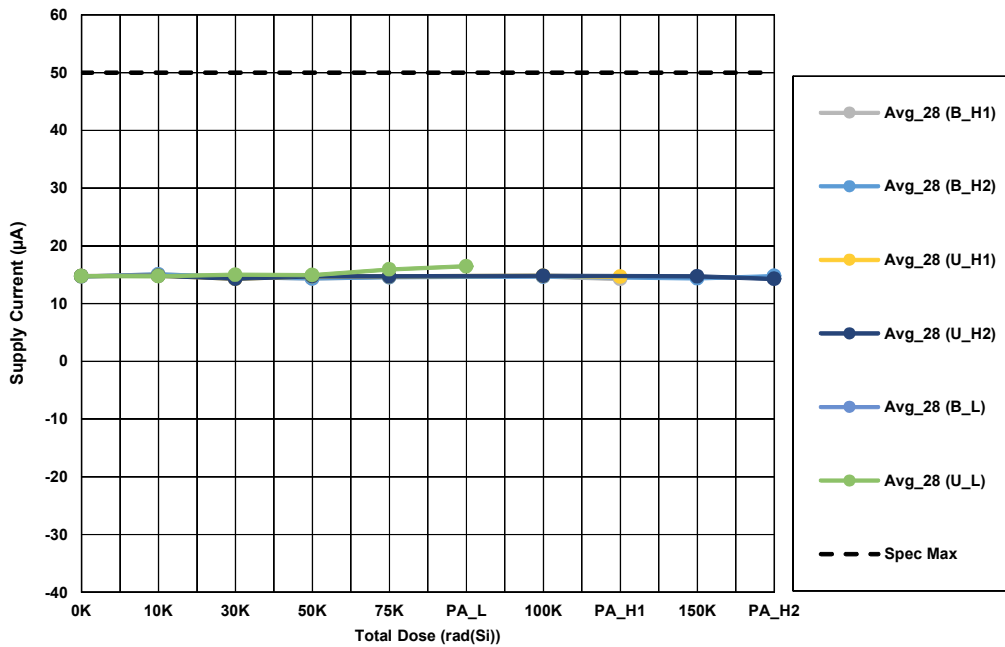

Figure 37. ISL72028CSEH supply current in low power shutdown mode ( $I_{CC(L)}$ ),  $RS = D = V_{CC}$ , as a function of low and high dose rate irradiation for the biased (B\_ - per Figure 4) and unbiased (U\_ - all pins grounded) cases. The post-irradiation SMD limit is 50µA maximum.

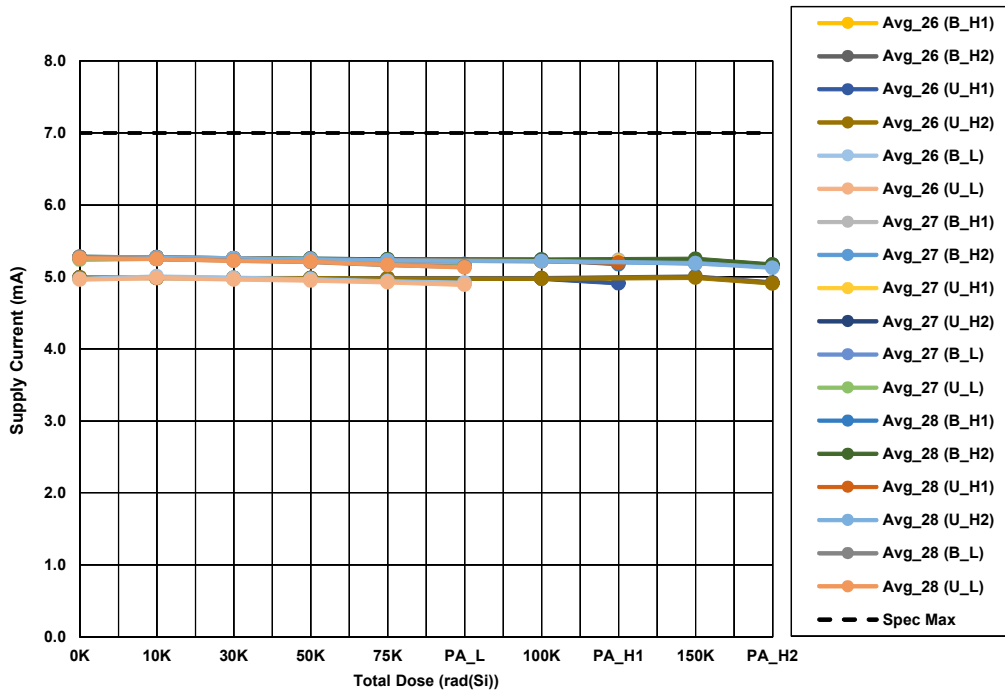

Figure 38. ISL72026CSEH, ISL72027CSEH, and ISL72028CSEH supply current in dominant mode ( $I_{CC(DOM)}$ ), at 3.0V supply,  $R_S = D = LBK = 0V$ , as a function of low and high dose rate irradiation for the biased (B\_ - per [Figure 4](#)) and unbiased (U\_ - all pins grounded) cases. The post-irradiation SMD limit is 7mA maximum.

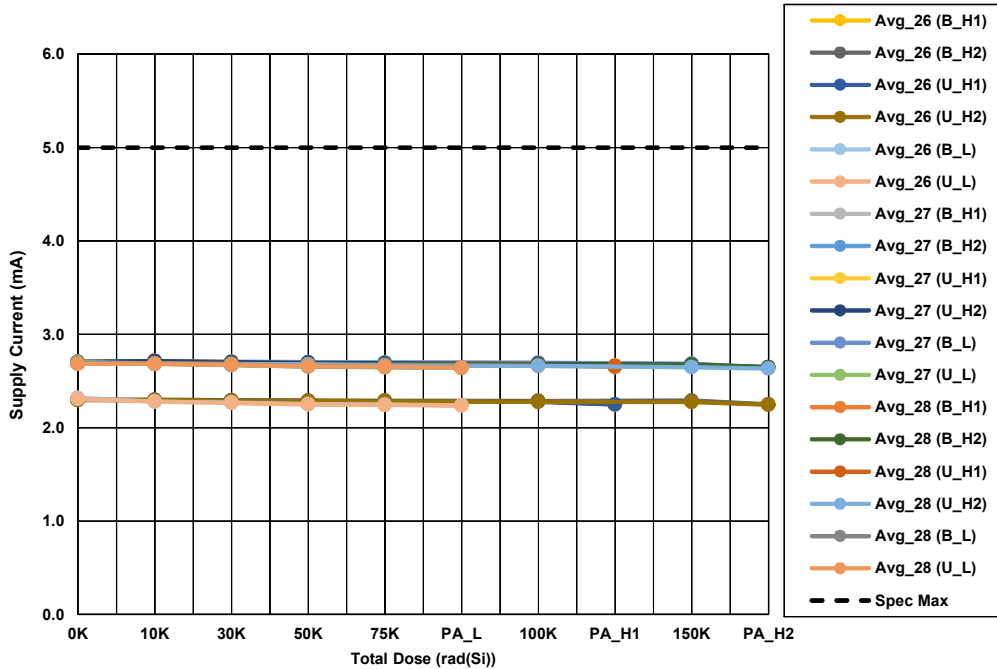

Figure 39. ISL72026CSEH, ISL72027CSEH, and ISL72028CSEH supply current in recessive mode ( $I_{CC(REC)}$ ), at 3.0V supply,  $R_S = LBK = 0V$ ,  $D = V_{CC}$ , as a function of low and high dose rate irradiation for the biased (B\_ - per [Figure 4](#)) and unbiased (U\_ - all pins grounded) cases. The post-irradiation SMD limit is 5mA maximum.

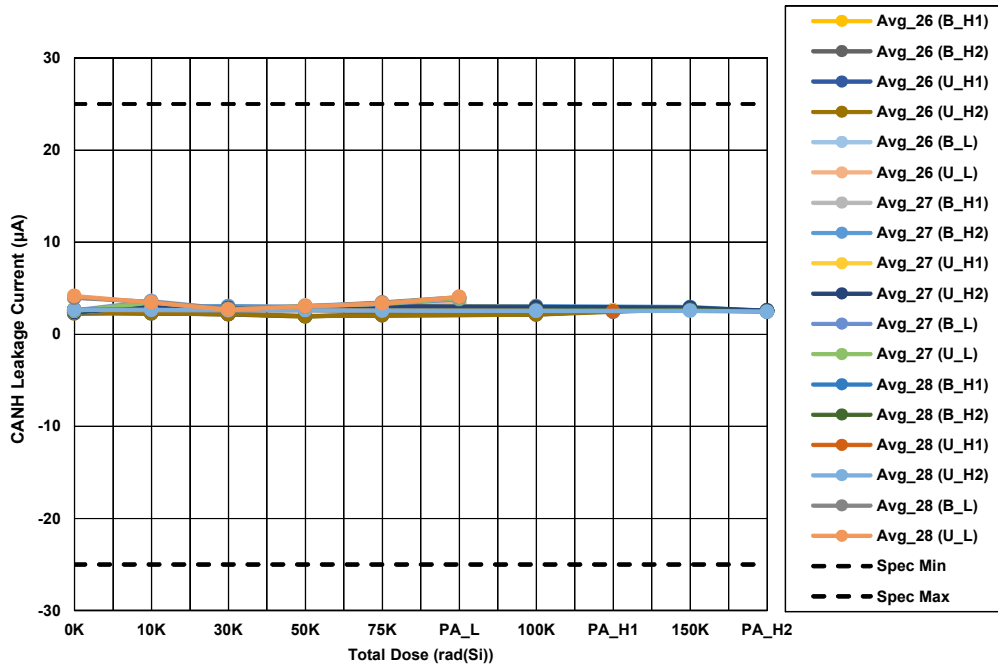

Figure 40. ISL72026CSEH, ISL72027CSEH, and ISL72028CSEH cold sparing CANH leakage current ( $I_L(CANH)$ ),  $V_{CC} = 0.2V$ ,  $V_{REF} = 12V$ ,  $R_S = 0V$ ,  $CANH = 12V$ ,  $CANL = open$ ,  $D = VS$ , as a function of low and high dose rate irradiation for the biased (B\_ - per Figure 4) and unbiased (U\_ - all pins grounded) cases. The post-irradiation SMD limits are  $-25\mu A$  to  $25\mu A$ .

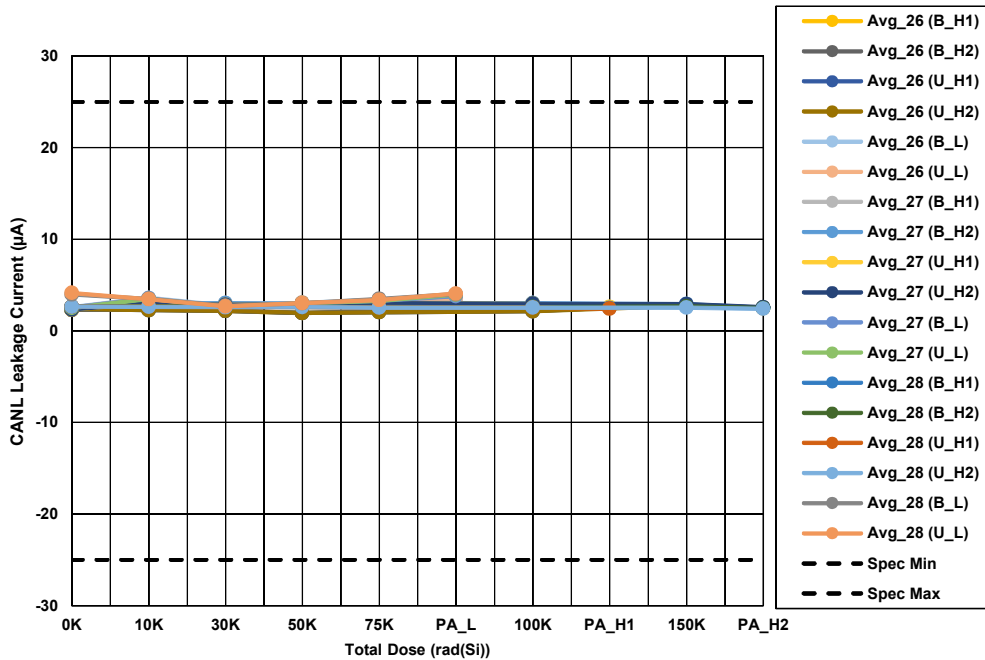

Figure 41. ISL72026CSEH, ISL72027CSEH, and ISL72028CSEH cold sparing CANL leakage current ( $I_L(CANL)$ ),  $V_{CC} = 0.2V$ ,  $V_{REF} = 12V$ ,  $R_S = 0V$ ,  $CANL = 12V$ ,  $CANH = open$ ,  $D = VS$ , as a function of low and high dose rate irradiation for the biased (B\_ - per Figure 4) and unbiased (U\_ - all pins grounded) cases. The post-irradiation SMD limits are  $-25\mu A$  to  $25\mu A$ .

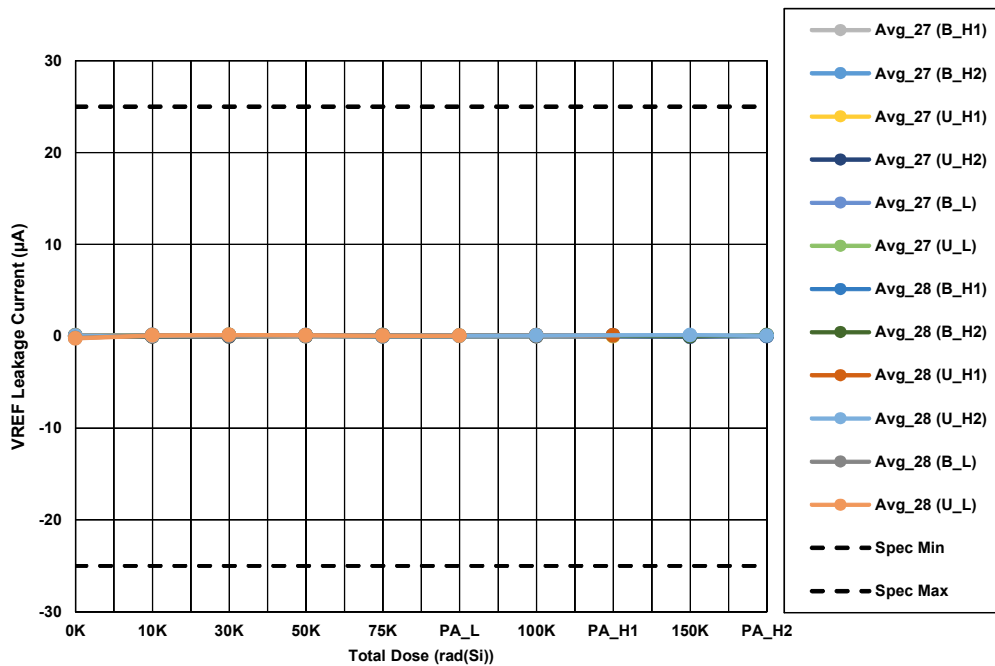

Figure 42. ISL72027CSEH and ISL72028CSEH cold sparing  $V_{REF}$  leakage current ( $I_L(V_{REF})$ ),  $V_{CC} = 0.2V$ ,  $V_{REF} = 12V$ ,  $D = VS$ , as a function of low and high dose rate irradiation for the biased (B\_ - per Figure 4) and unbiased (U\_ - all pins grounded) cases. The post-irradiation SMD limits are  $-25\mu A$  to  $25\mu A$ .

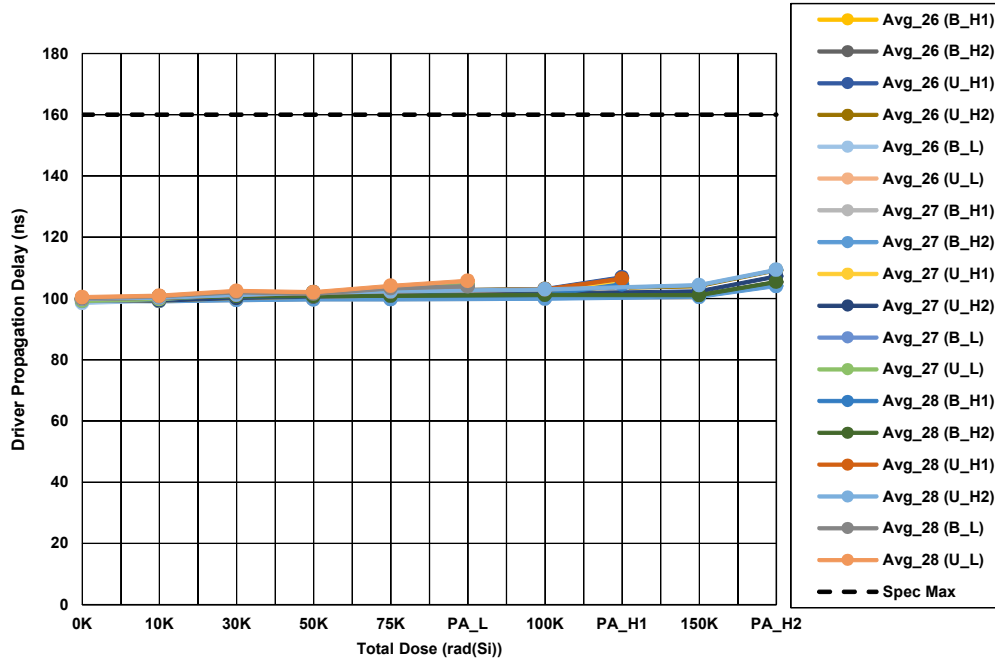

Figure 43. ISL72026CSEH, ISL72027CSEH, and ISL72028CSEH driver propagation delay, LOW to HIGH ( $t_{PLH}$ ), for a 3.0V supply,  $R_S = 0V$ , as a function of low and high dose rate irradiation for the biased (B\_ - per Figure 4) and unbiased (U\_ - all pins grounded) cases. The post-irradiation SMD limit is 160ns maximum.

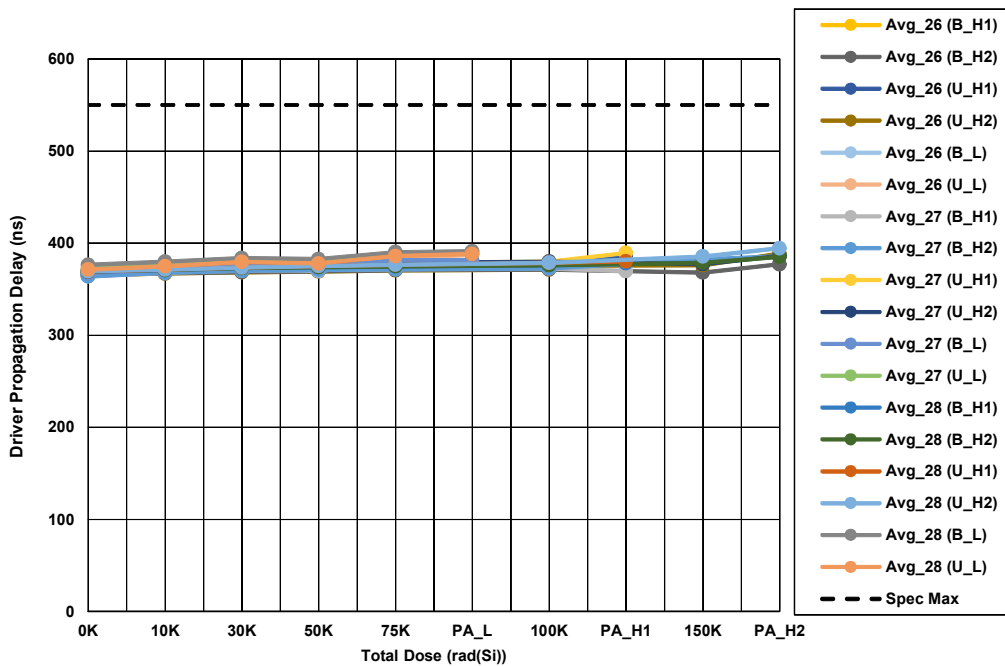

Figure 44. ISL72026CSEH, ISL72027CSEH, and ISL72028CSEH driver propagation delay, LOW to HIGH ( $t_{pLH}$ ), for a 3.0V supply,  $R_S = 10k\Omega$ , as a function of low and high dose rate irradiation for the biased (B\_ - per Figure 4) and unbiased (U\_ - all pins grounded) cases. The post-irradiation SMD limit is 550ns maximum.

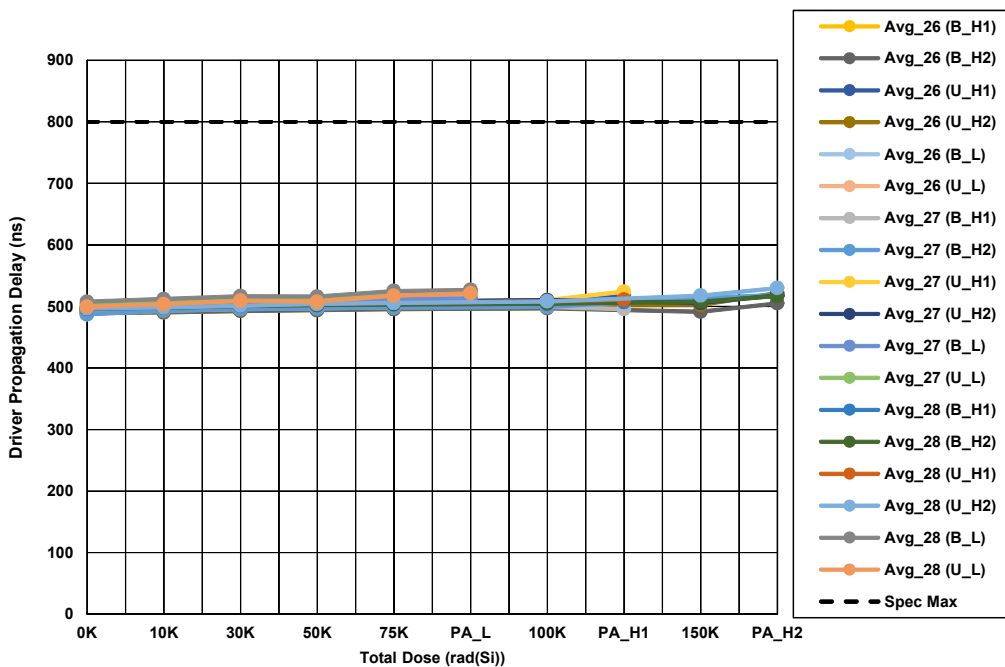

Figure 45. ISL72026CSEH, ISL72027CSEH, and ISL72028CSEH driver propagation delay, LOW to HIGH ( $t_{pLH}$ ), for a 3.0V supply,  $R_S = 50k\Omega$ , as a function of low and high dose rate irradiation for the biased (B\_ - per Figure 4) and unbiased (U\_ - all pins grounded) cases. The post-irradiation SMD limit is 800ns maximum.

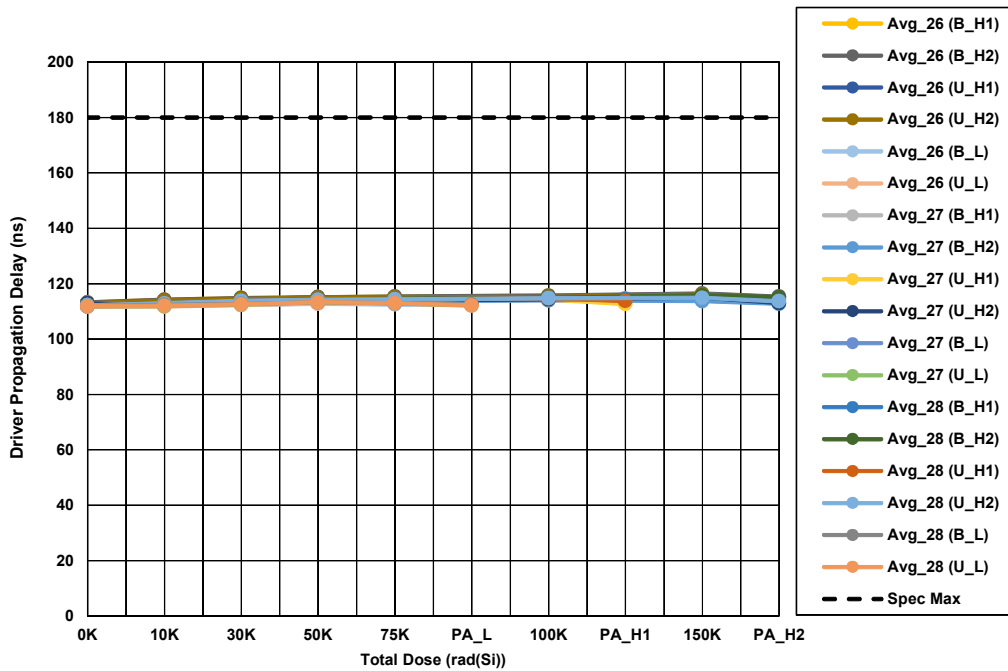

Figure 46. ISL72026CSEH, ISL72027CSEH, and ISL72028CSEH driver propagation delay, HIGH to LOW ( $t_{PHL}$ ), for a 3.0V supply,  $R_S = 0\Omega$ , as a function of low and high dose rate irradiation for the biased ( $B_-$  - per [Figure 4](#)) and unbiased ( $U_-$  - all pins grounded) cases. The post-irradiation SMD limit is 180ns maximum.

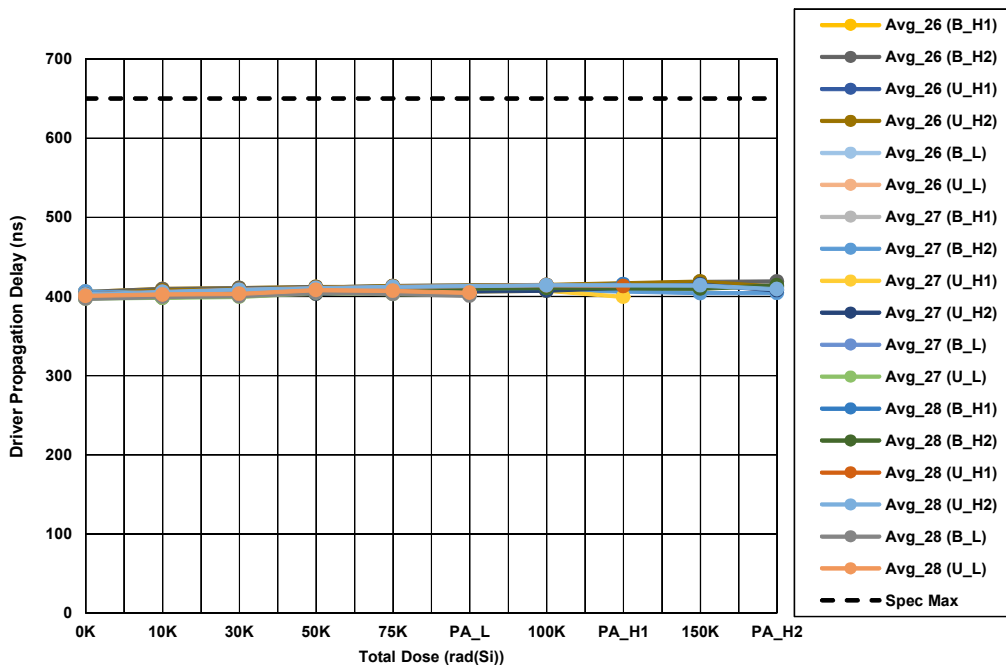

Figure 47. ISL72026CSEH, ISL72027CSEH, and ISL72028CSEH driver propagation delay, HIGH to LOW ( $t_{PHL}$ ), for a 3.0V supply,  $R_S = 10k\Omega$ , as a function of low and high dose rate irradiation for the biased ( $B_-$  - per [Figure 4](#)) and unbiased ( $U_-$  - all pins grounded) cases. The post-irradiation SMD limit is 650ns maximum.

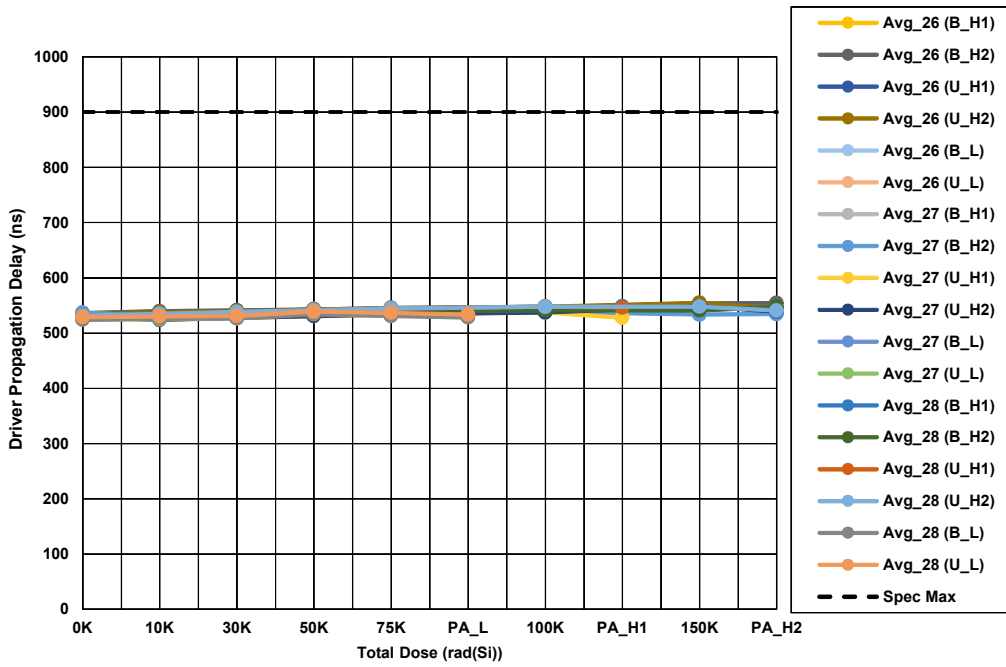

Figure 48. ISL72026CSEH, ISL72027CSEH, and ISL72028CSEH driver propagation delay, HIGH to LOW ( $t_{PHL}$ ), for a 3.0V supply,  $R_S = 50k\Omega$ , as a function of low and high dose rate irradiation for the biased (B\_ - per Figure 4) and unbiased (U\_ - all pins grounded) cases. The post-irradiation SMD limit is 900ns maximum.

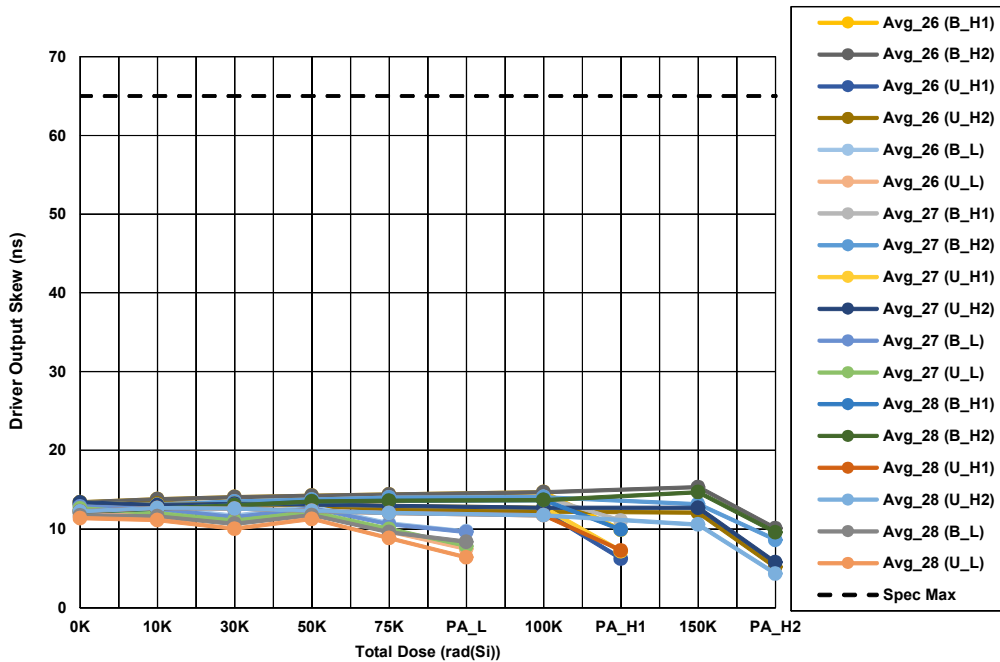

Figure 49. ISL72026CSEH, ISL72027CSEH, and ISL72028CSEH driver output skew ( $t_{SKEW} = t_{PHL} - t_{PLH}$ ) for a 3.0V supply,  $R_S = 0V$ , as a function of low and high dose rate irradiation for the biased (B\_ - per Figure 4) and unbiased (U\_ - all pins grounded) cases. The post-irradiation SMD limit is 65ns maximum.

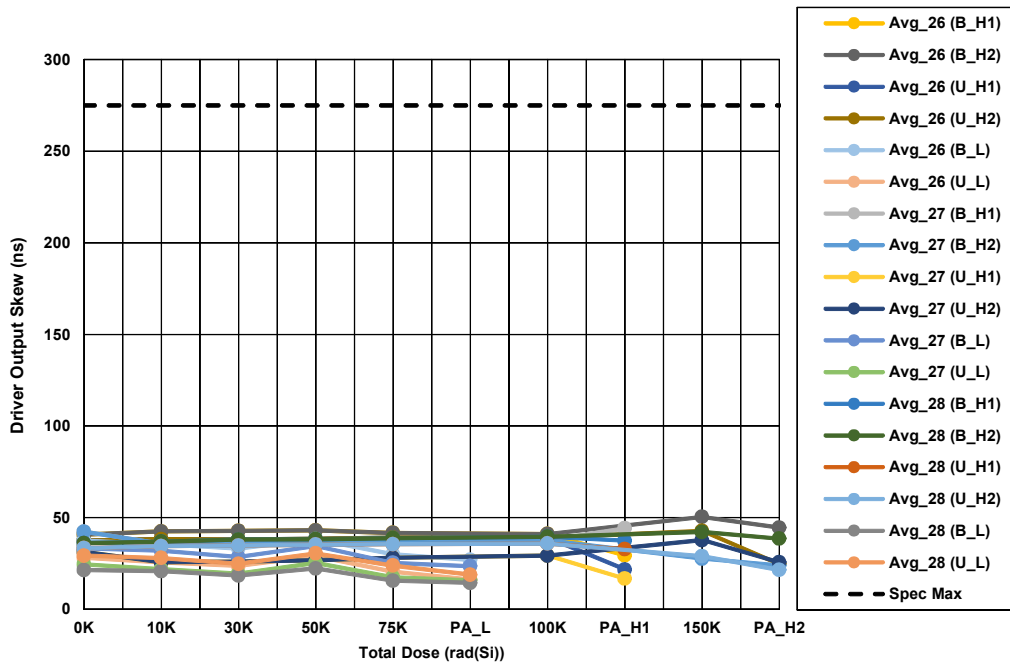

Figure 50. ISL72026CSEH, ISL72027CSEH, and ISL72028CSEH driver output skew ( $t_{SKEW} = t_{PHL} - t_{PLH}$ ) for a 3.0V supply,  $R_S = 10k\Omega$ , as a function of low and high dose rate irradiation for the biased (B\_ - per Figure 4) and unbiased (U\_ - all pins grounded) cases. The post-irradiation SMD limit is 275ns maximum.

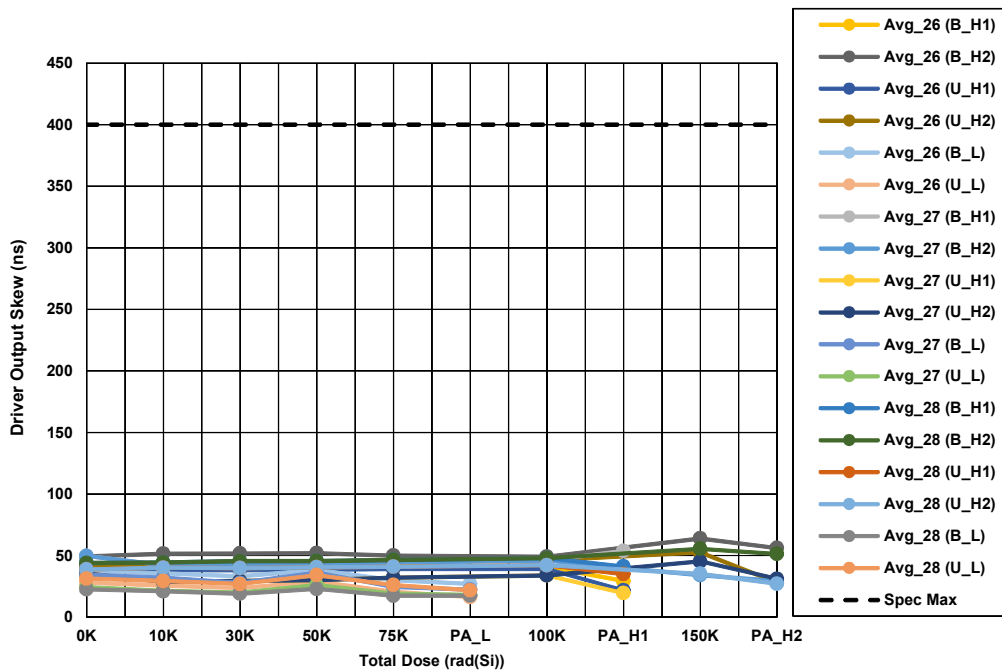

Figure 51. ISL72026CSEH, ISL72027CSEH, and ISL72028CSEH driver output skew ( $t_{SKEW} = t_{PHL} - t_{PLH}$ ) for a 3.0V supply,  $R_S = 50k\Omega$ , as a function of low and high dose rate irradiation for the biased (B\_ - per Figure 4) and unbiased (U\_ - all pins grounded) cases. The post-irradiation SMD limit is 400ns maximum.



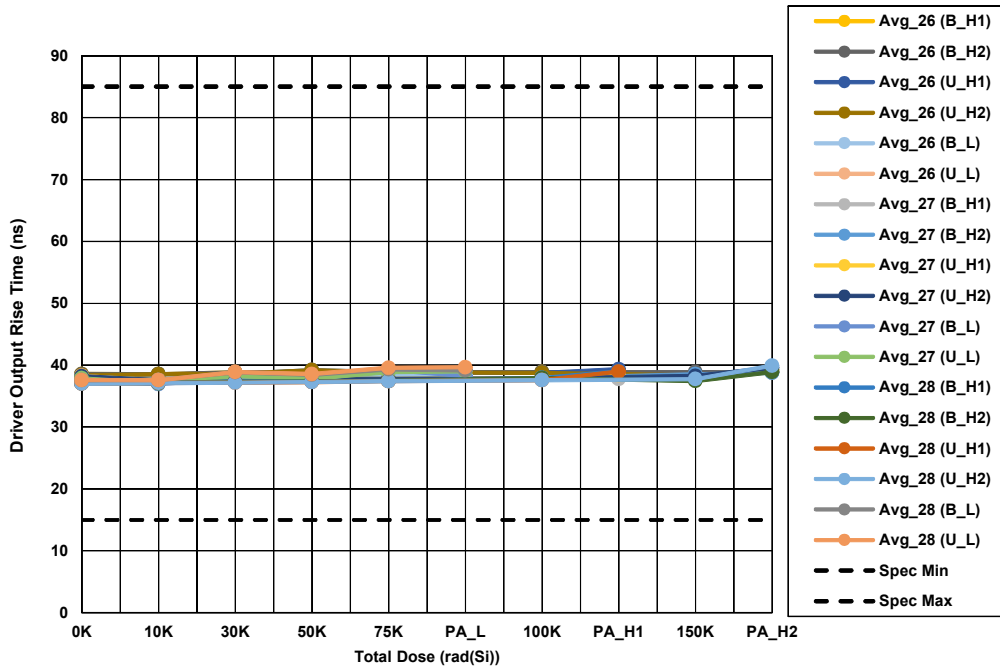

Figure 52. ISL72026CSEH, ISL72027CSEH, and ISL72028CSEH driver output rise time for a 3.0V supply, RS = 0V, as a function of low and high dose rate irradiation for the biased (B\_ - per Figure 4) and unbiased (U\_ - all pins grounded) cases. The post-irradiation SMD limits are 15ns to 85ns.

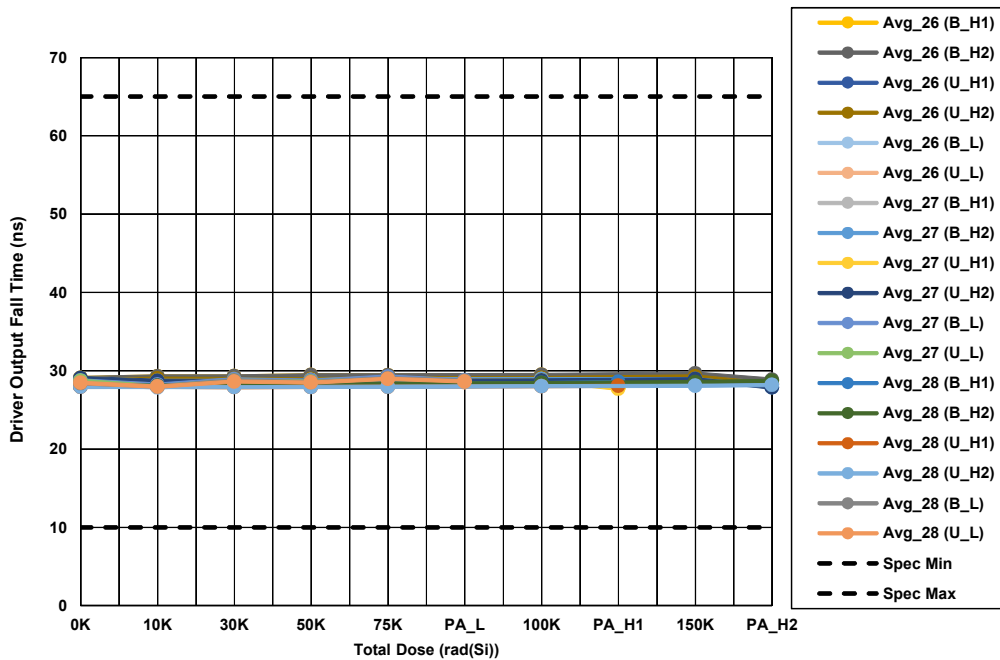

Figure 53. ISL72026CSEH, ISL72027CSEH, and ISL72028CSEH driver output fall time for a 3.0V supply, RS = 0V, as a function of low and high dose rate irradiation for the biased (B\_ - per Figure 4) and unbiased (U\_ - all pins grounded) cases. The post-irradiation SMD limits are 10ns to 65ns.

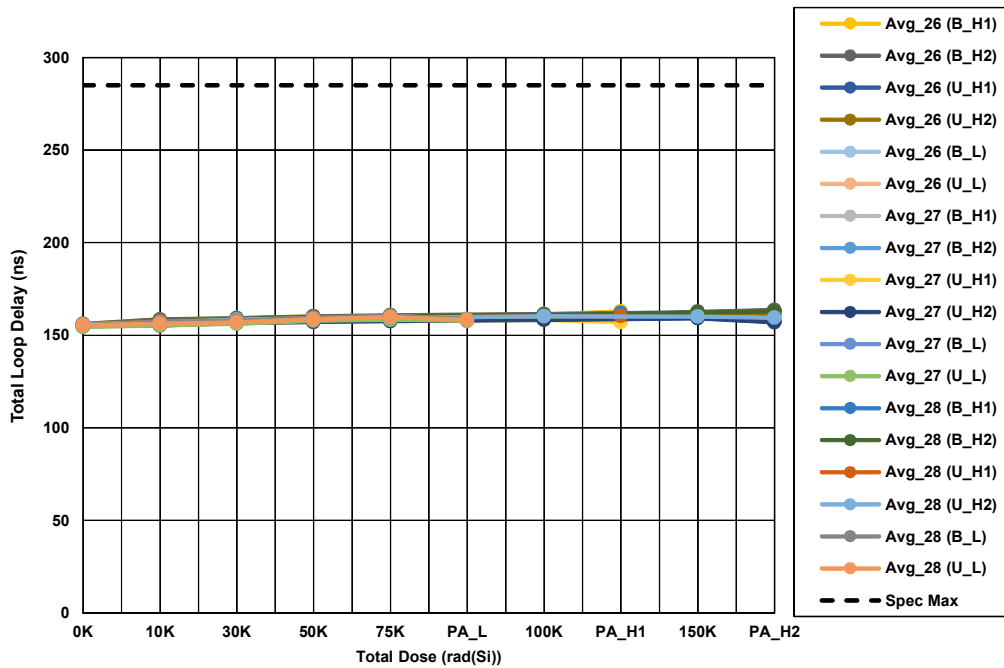

Figure 54. ISL72026CSEH, ISL72027CSEH, and ISL72028CSEH total loop delay, ( $t_{LOOP2}$ ), driver input to receiver output, dominant to recessive, for a 3.0V supply,  $R_S = 0V$ , as a function of low and high dose rate irradiation for the biased (B\_ - per Figure 4) and unbiased (U\_ - all pins grounded) cases. The post-irradiation SMD limit is 285ns maximum.

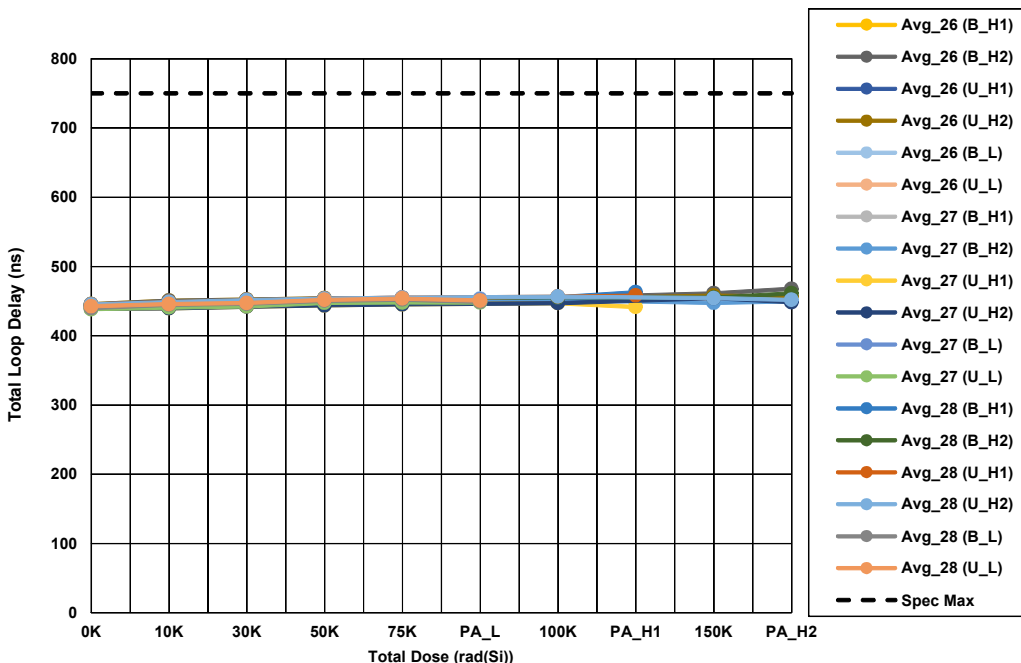

Figure 55. ISL72026CSEH, ISL72027CSEH, and ISL72028CSEH total loop delay, ( $t_{LOOP2}$ ), driver input to receiver output, dominant to recessive, for a 3.0V supply,  $R_S = 10k\Omega$ , as a function of low and high dose rate irradiation for the biased (B\_ - per Figure 4) and unbiased (U\_ - all pins grounded) cases. The post-irradiation SMD limit is 750ns maximum.

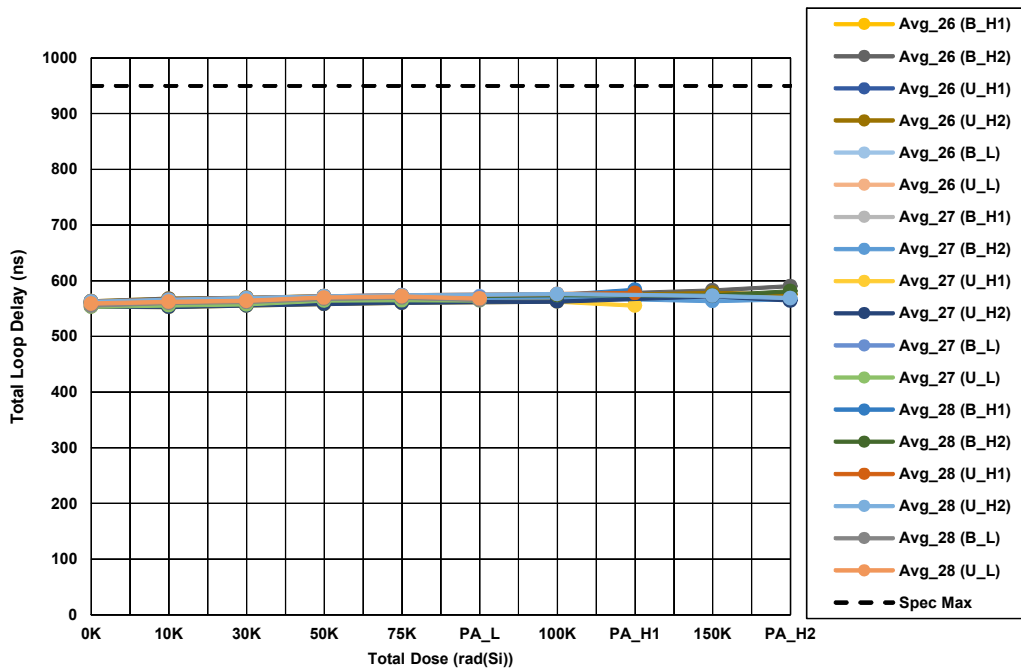

Figure 56. ISL72026CSEH, ISL72027CSEH, and ISL72028CSEH total loop delay, ( $t_{LOOP2}$ ), driver input to receiver output, dominant to recessive, for a 3.0V supply,  $R_S = 50k\Omega$ , as a function of low and high dose rate irradiation for the biased (B\_ - per Figure 4) and unbiased (U\_ - all pins grounded) cases. The post-irradiation SMD limit is 950ns maximum.

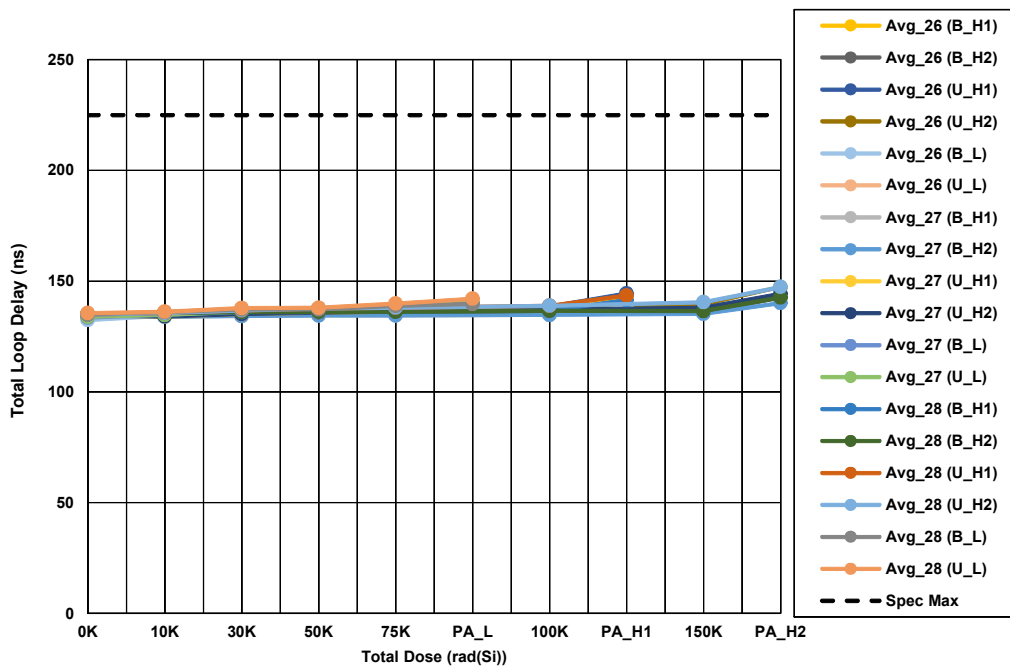

Figure 57. ISL72026CSEH, ISL72027CSEH, and ISL72028CSEH total loop delay, ( $t_{LOOP1}$ ), driver input to receiver output, recessive to dominant, for a 3.0V supply,  $R_S = 0V$ , as a function of low and high dose rate irradiation for the biased (B\_ - per Figure 4) and unbiased (U\_ - all pins grounded) cases. The post-irradiation SMD limit is 225ns maximum.

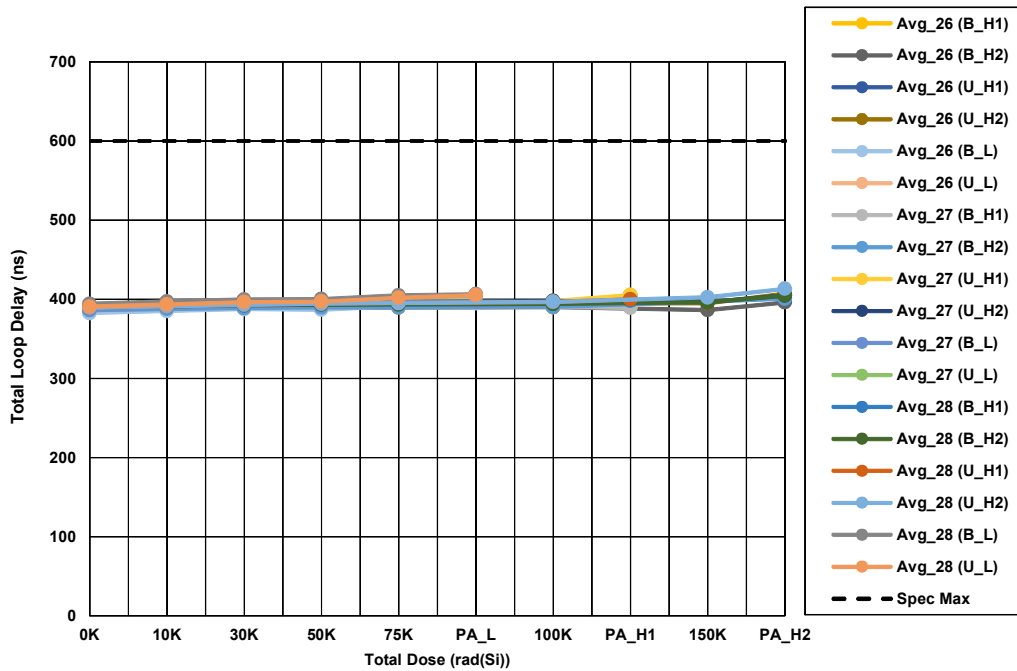

Figure 58. ISL72026CSEH, ISL72027CSEH, and ISL72028CSEH driver total loop delay, ( $t_{LOOP1}$ ), driver input to receiver output, recessive to dominant, for a 3.0V supply,  $R_S = 10k\Omega$ , as a function of low and high dose rate irradiation for the biased (B\_ - per Figure 4) and unbiased (U\_ - all pins grounded) cases. The post-irradiation SMD limit is 600ns maximum.

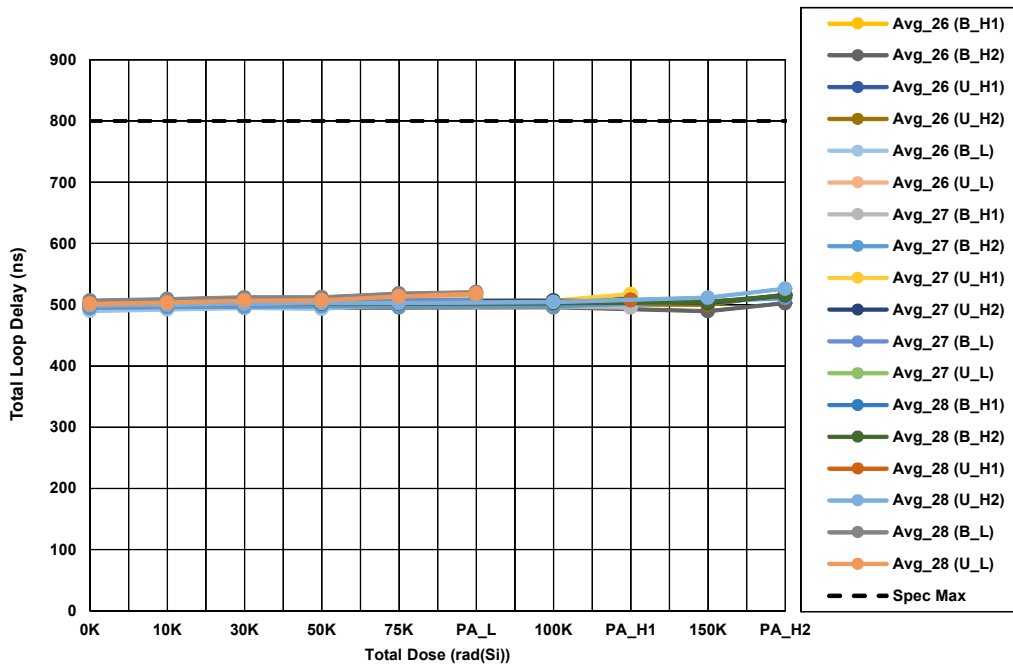

Figure 59. ISL72026CSEH, ISL72027CSEH, and ISL72028CSEH driver total loop delay, ( $t_{LOOP1}$ ), driver input to receiver output, recessive to dominant, for a 3.0V supply,  $R_S = 50k\Omega$ , as a function of low and high dose rate irradiation for the biased (B\_ - per Figure 4) and unbiased (U\_ - all pins grounded) cases. The post-irradiation SMD limit is 800ns maximum.

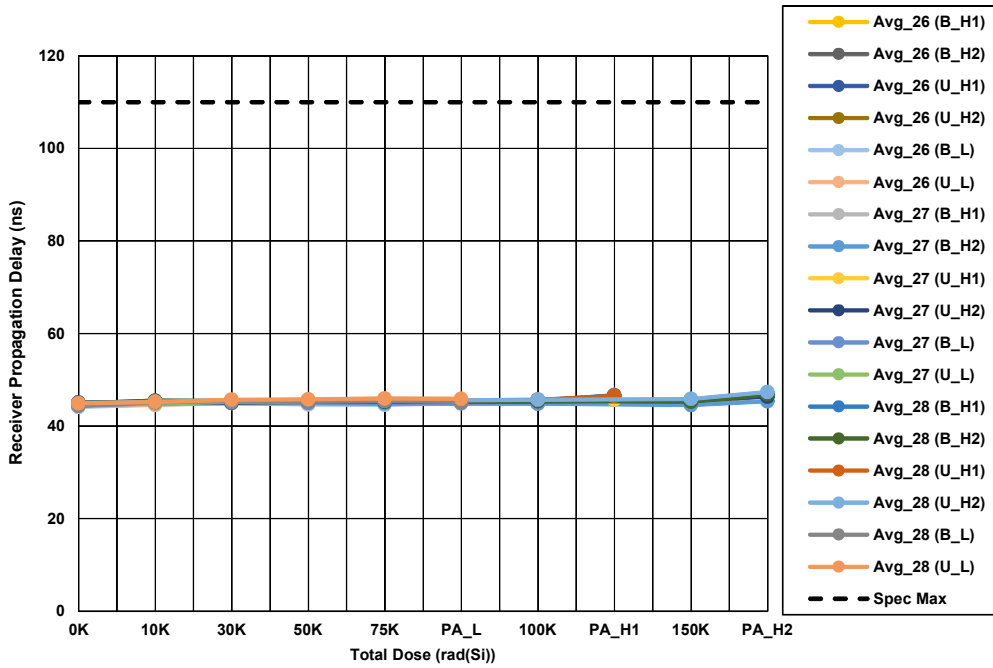

Figure 60. ISL72026CSEH, ISL72027CSEH, and ISL72028CSEH receiver propagation delay, dominant to recessive, ( $T_{PHL}$ ), for a 3.0V supply, as a function of low and high dose rate irradiation for the biased (B\_ - per [Figure 4](#)) and unbiased (U\_ - all pins grounded) cases. The post-irradiation SMD limit is 110ns maximum.

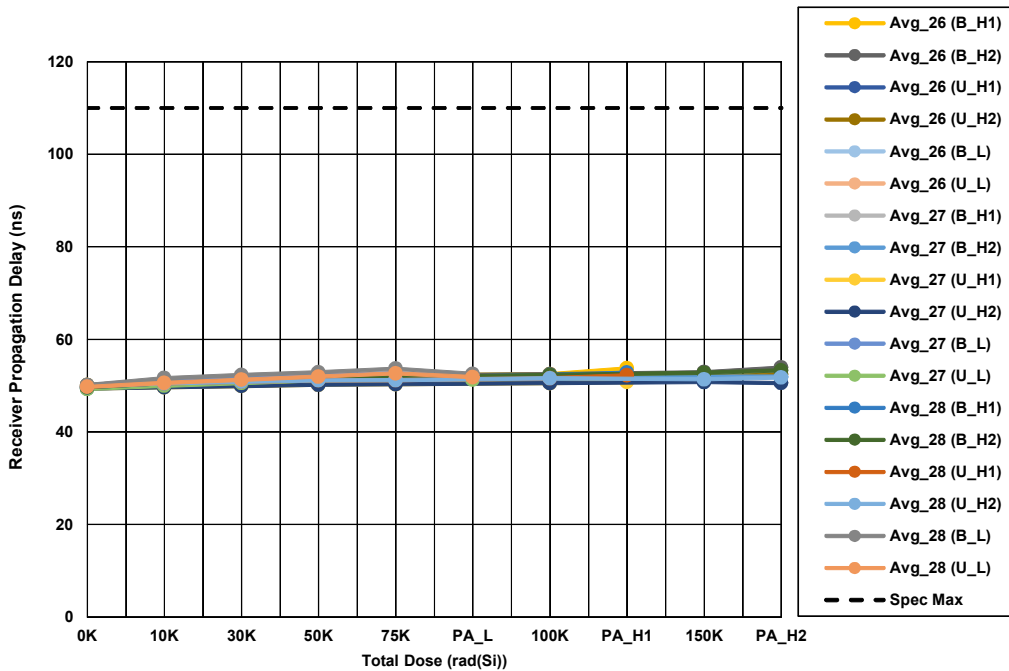

Figure 61. ISL72026CSEH, ISL72027CSEH, and ISL72028CSEH receiver propagation delay, recessive to dominant ( $T_{PLH}$ ), for a 3.0V supply, as a function of low and high dose rate irradiation for the biased (B\_ - per [Figure 4](#)) and unbiased (U\_ - all pins grounded) cases. The post-irradiation SMD limit is 110ns maximum.

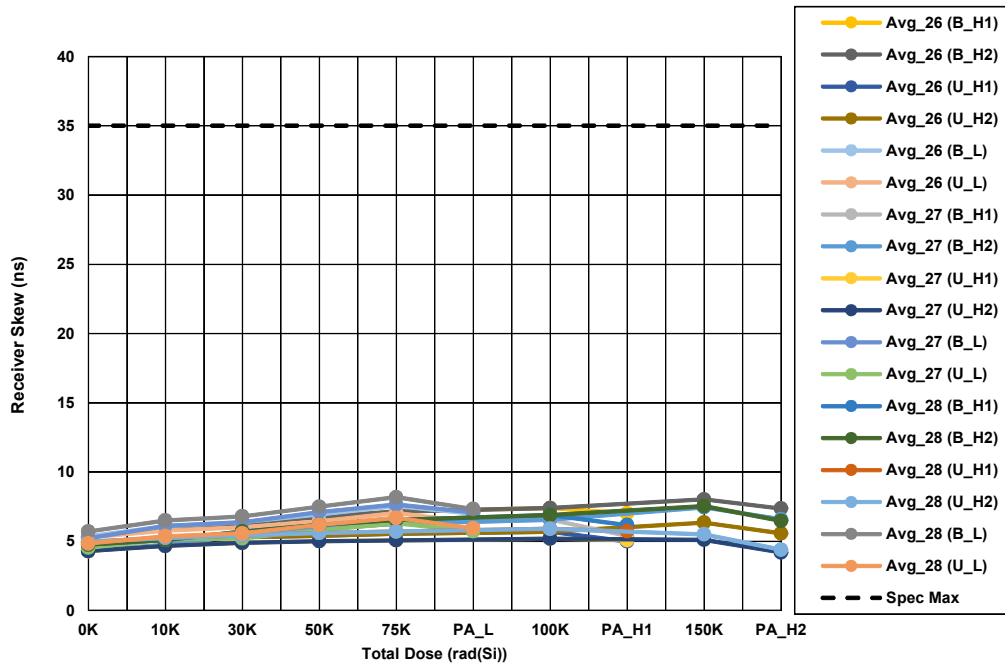

Figure 62. ISL72026CSEH, ISL72027CSEH, and ISL72028CSEH receiver skew ( $t_{SKEW1} = t_{PHL} - t_{PLH}$ ) for a 3.0V supply, as a function of low and high dose rate irradiation for the biased (B\_ - per Figure 4) and unbiased (U\_ - all pins grounded) cases. The post-irradiation SMD limit is 35ns maximum.

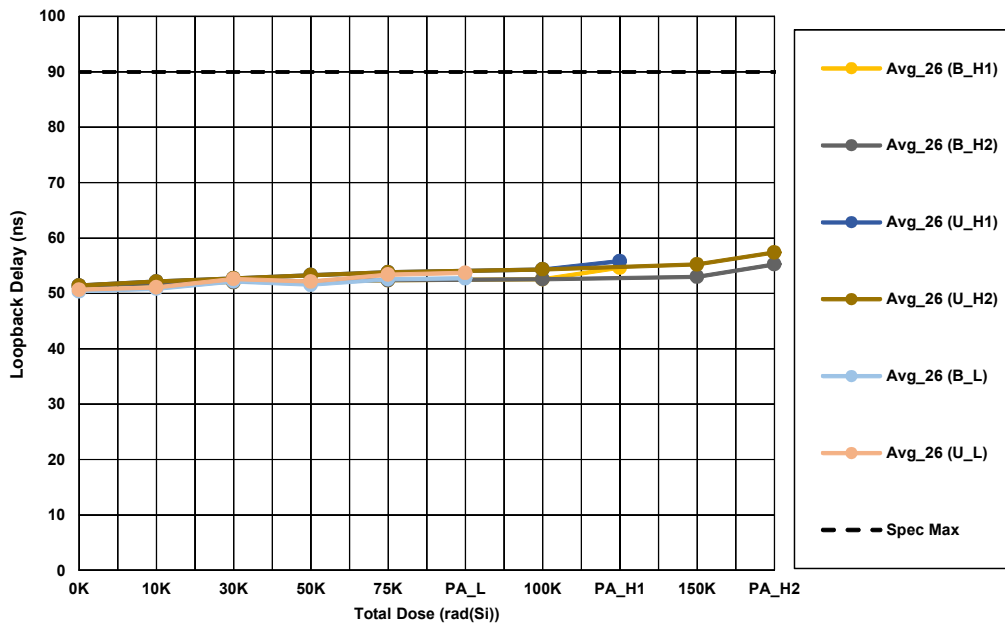

Figure 63. ISL72026CSEH loopback HIGH to LOW delay ( $t_{LBK}$ ), for a 3.0V supply, IO to receiver output, as a function of low and high dose rate irradiation for the biased (B\_ - per Figure 4) and unbiased (U\_ - all pins grounded) cases. The post-irradiation SMD limit is 90ns maximum.

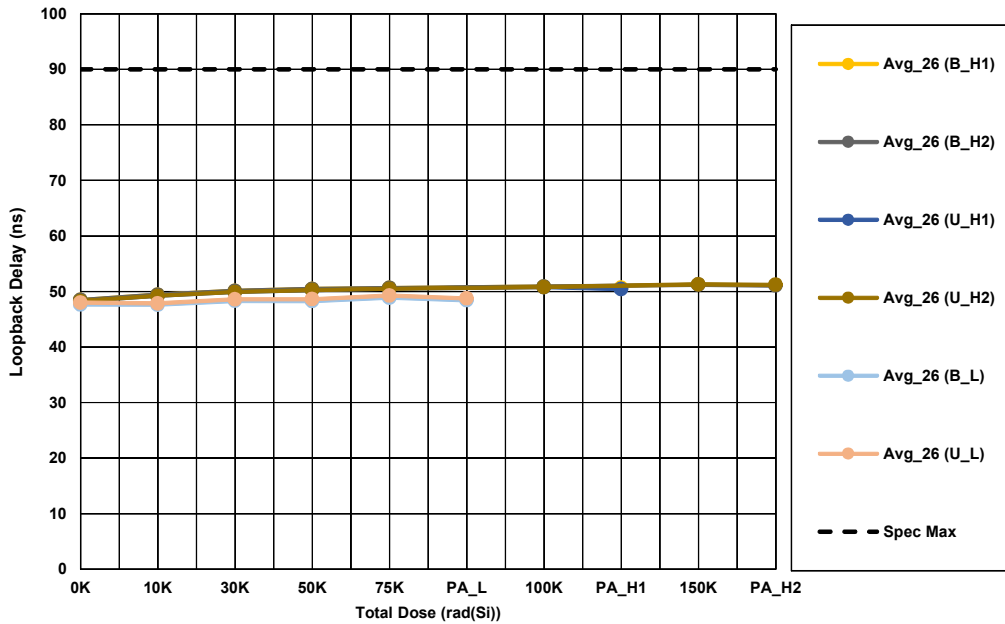

Figure 64. ISL72026CSEH loopback LOW to HIGH delay ( $t_{LBK}$ ), for a 3.0V supply, IO to receiver output, as a function of low and high dose rate irradiation for the biased (B\_ - per Figure 4) and unbiased (U\_ - all pins grounded) cases. The post-irradiation SMD limit is 90ns maximum.

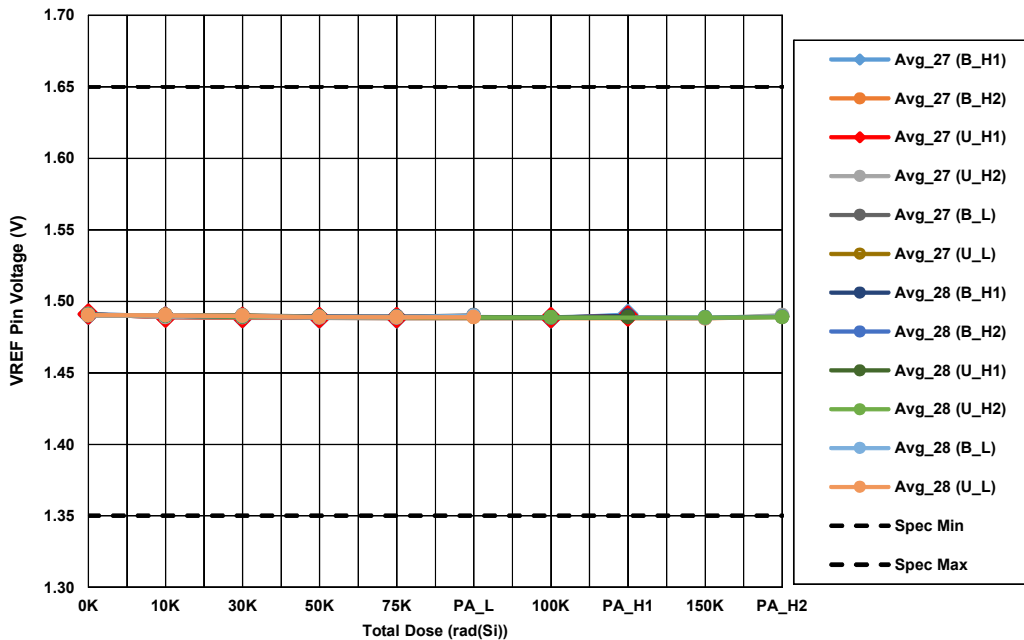

Figure 65. ISL72027CSEH and ISL72028CSEH reference pin voltage ( $V_{REF}$ ), for a 3.0V supply, sinking 5 $\mu$ A, as a function of low and high dose rate irradiation for the biased (B\_ - per Figure 4) and unbiased (U\_ - all pins grounded) cases. The post-irradiation SMD limits are 1.35V to 1.65V.

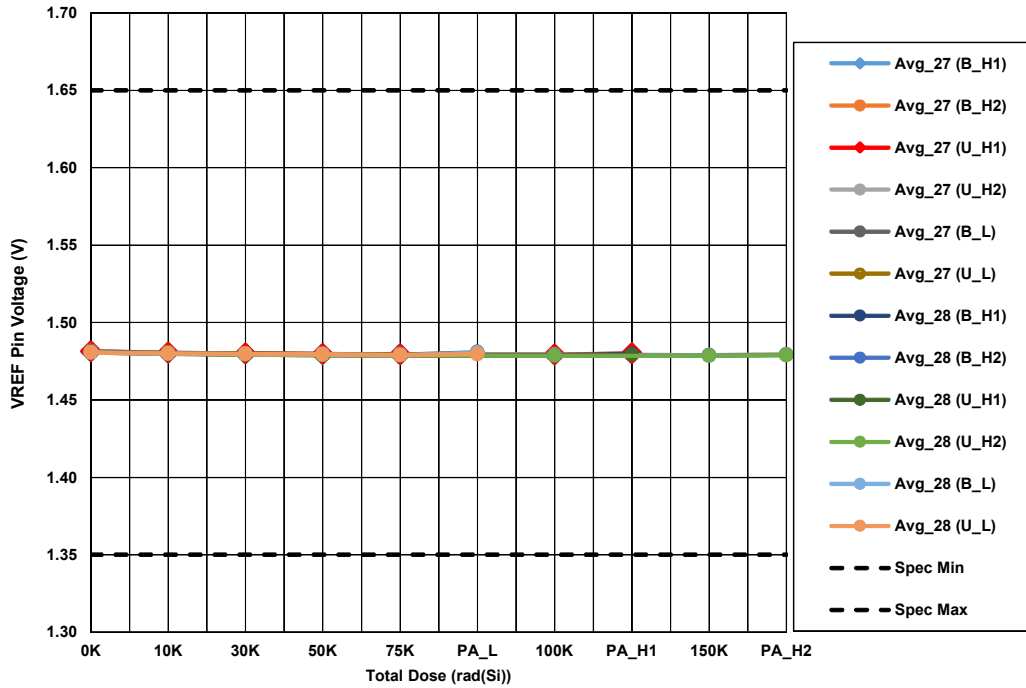

Figure 66. ISL72027CSEH and ISL72028CSEH reference pin voltage ( $V_{REF}$ ), for a 3.0V supply, sourcing  $5\mu A$ , as a function of low and high dose rate irradiation for the biased ( $B_{-}$  - per [Figure 4](#)) and unbiased ( $U_{-}$  - all pins grounded) cases. The post-irradiation SMD limits are 1.35V to 1.65V.

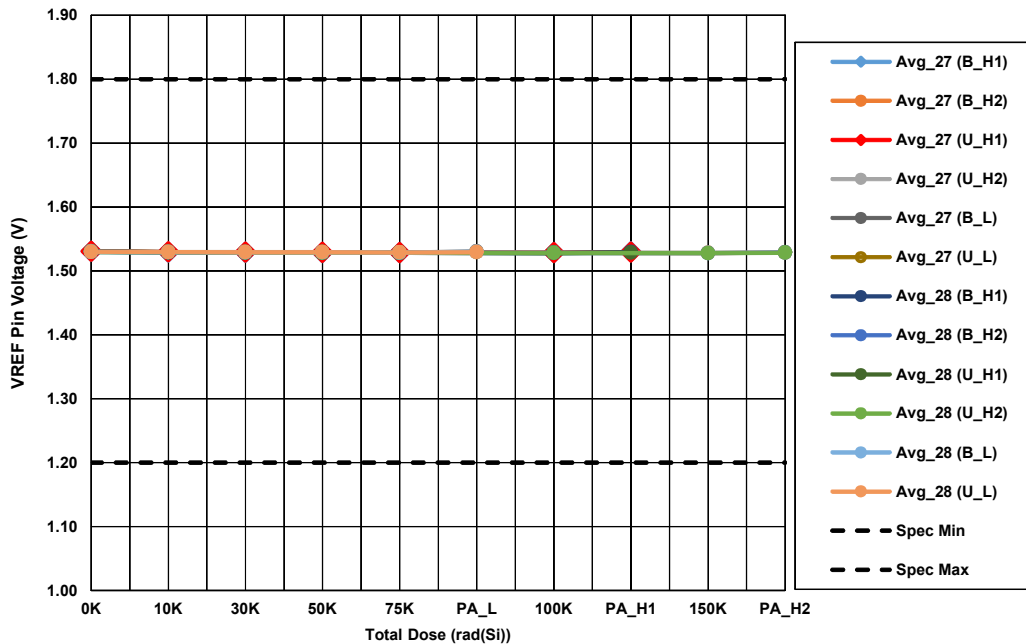

Figure 67. ISL72027CSEH and ISL72028CSEH reference pin voltage ( $V_{REF}$ ), for a 3.0V supply, sinking  $50\mu A$ , as a function of low and high dose rate irradiation for the biased ( $B_{-}$  - per [Figure 4](#)) and unbiased ( $U_{-}$  - all pins grounded) cases. The post-irradiation SMD limits are 1.2V to 1.8V.



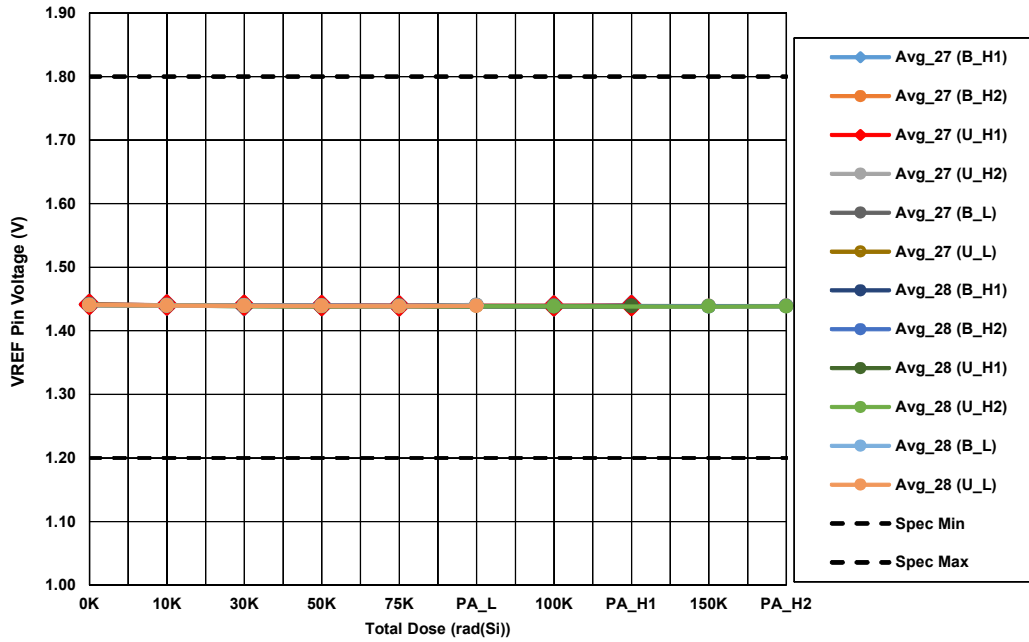

Figure 68. ISL72027CSEH and ISL72028CSEH reference pin voltage ( $V_{REF}$ ), for a 3.0V supply, sourcing 50 $\mu$ A, as a function of low and high dose rate irradiation for the biased (B\_ - per Figure 4) and unbiased (U\_ - all pins grounded) cases. The post-irradiation SMD limits are 1.2V to 1.8V.

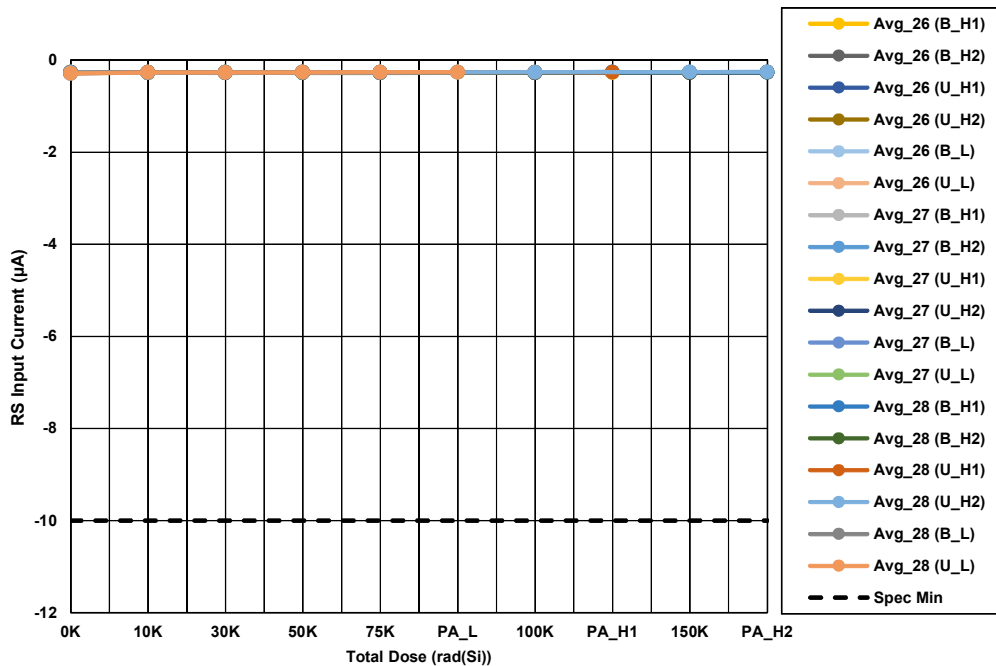

Figure 69. ISL72026CSEH, ISL72027CSEH, and ISL72028CSEH RS input current for a 3.6V supply, ( $I_{RS}$ ), high speed mode, as a function of low and high dose rate irradiation for the biased (B\_ - per Figure 4) and unbiased (U\_ - all pins grounded) cases. The post-irradiation SMD limit is -10 $\mu$ A minimum.

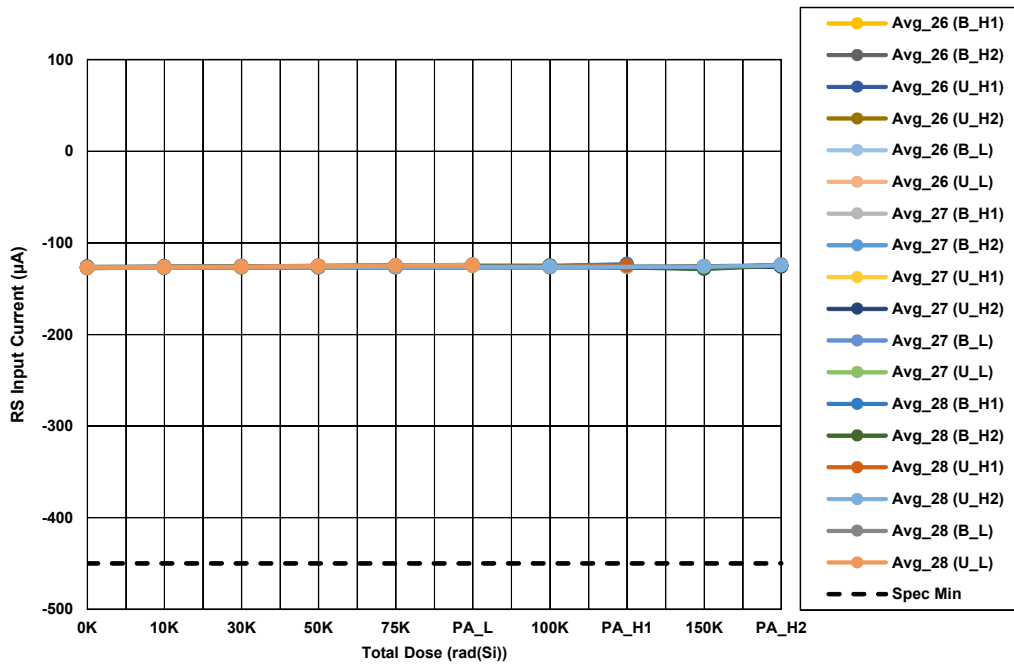

Figure 70. ISL72026CSEH, ISL72027CSEH, and ISL72028CSEH RS input current, ( $I_{RSL}$ ), listen mode, as a function of low and high dose rate irradiation for the biased (B\_ - per Figure 4) and unbiased (U\_ - all pins grounded) cases. The post-irradiation SMD limit is  $-450\mu\text{A}$  minimum.

## 4. Conclusion

This document reports the results of a total dose test of the ISL72026CSEH, ISL72027CSEH, and ISL72028CSEH Controller Area Network (CAN) transceivers. The test was conducted to determine the sensitivity of the parts at low and high dose rates. Parts were tested to 75krad(Si) at low dose rate under biased and unbiased conditions, and to 150krad(Si) at high dose rate. Both types of irradiation were performed as outlined in MIL-STD-883 Test Method 1019. The low dose rate samples were subjected to a high temperature biased anneal at +100°C for 168 hours after 75krad(Si). The high dose rate samples were split after 100krad(Si), with half undergoing a high temperature biased anneal at +100°C for 168 hours, and the other half being exposed to 150krad(Si) before undergoing the same anneal.

ATE characterization testing at downpoints showed no rejects to the SMD Group A parametric limits (indicated by a 'Bin 1' category) after biased and grounded irradiation and after the 168 hour +100°C biased anneals. Attributes data are presented in [Table 2](#) and variables data for selected parameters are plotted in [Figures 5](#) through [70](#) and are shown in [Table 3](#). No differences between variants at low and high dose rate and biased and unbiased irradiation responses were noted, and the part is not considered bias sensitive.

**Table 3. Reported Parameters**

Figure	Parameter	Limit Low	Limit High	Unit	Notes
<a href="#">5</a>	Dominant Bus Output Voltage	2.25	3.0	V	D = 0V
<a href="#">6</a>	Dominant Bus Output Voltage	0.1	1.25	V	D = 0V
<a href="#">7</a>	Recessive Bus Output Voltage	1.8	2.7	V	D = 3V
<a href="#">8</a>	Recessive Bus Output Voltage	1.8	2.8	V	D = 3V
<a href="#">9</a>	Dominant Differential Output Voltage	1.5	3.0	V	D = 0V
<a href="#">10</a>	Recessive Differential Output Voltage	-120	12	mV	D = 3V
<a href="#">11</a>	Logic High Input Current	-30	30	μA	D input High
<a href="#">12</a>	Logic Low Input Current	-30	30	μA	D input Low
<a href="#">13</a>	Output Short-Circuit Current	-250	-	mA	CANH = -7V, CANL open
<a href="#">14</a>	Output Short-Circuit Current	-	250	mA	CANL = 12V, CANH open
<a href="#">15</a>	Output Short-Circuit Current	-	1.0	mA	CANH = 12V, CANL open
<a href="#">16</a>	Output Short-Circuit Current	-1.0	-	mA	CANL = -7V, CANH open
<a href="#">17</a>	Input Threshold Voltage, Rising	-	900	mV	RS = 0V, 10k and 50k
<a href="#">18</a>	Input Threshold Voltage, Falling	500	-	mV	RS = 0V, 10k and 50k
<a href="#">19</a>	Input Hysteresis Voltage	40	-	mV	
<a href="#">20</a>	Input Threshold Voltage, Rising, Listen Mode	-	900	mV	RS = 0V
<a href="#">21</a>	Input Threshold Voltage, Falling, Listen Mode	325	-	mV	RS = 0V
<a href="#">22</a>	Input Hysteresis Voltage, Listen Mode	40	-	mV	
<a href="#">23</a>	Receiver Output High Voltage	2.4	-	V	I <sub>OUT</sub> = -4mA
<a href="#">24</a>	Receiver Output Low Voltage	-	0.4	V	I <sub>OUT</sub> = 4mA
<a href="#">25</a>	CAN Bus Input Current	-	600	μA	CANH = 12V
<a href="#">26</a>	CAN Bus Input Current	-	600	μA	CANL = 12V
<a href="#">27</a>	CAN Bus Input Current, Supply Off	-	275	μA	CANH = 12V, V <sub>CC</sub> = 0V
<a href="#">28</a>	CAN Bus Input Current, Supply Off	-	275	μA	CANL = 12V, V <sub>CC</sub> = 0V
<a href="#">29</a>	CAN Bus Input Current	-500	-	μA	CANH = -7V
<a href="#">30</a>	CAN Bus Input Current	-500	-	μA	CANL = -7V
<a href="#">31</a>	CAN Bus Input Current, Supply Off	-175	-	μA	CANH = -7V, V <sub>CC</sub> = 0V
<a href="#">32</a>	CAN Bus Input Current, Supply Off	-175	-	μA	CANL = -7V, V <sub>CC</sub> = 0V
<a href="#">33</a>	Input Resistance	20.0	50.0	kΩ	

Table 3. Reported Parameters

Figure	Parameter	Limit Low	Limit High	Unit	Notes
<a href="#">34</a>	Input Resistance	20.0	50.0	k $\Omega$	
<a href="#">35</a>	Differential Input Resistance	40.0	100.0	k $\Omega$	
<a href="#">36</a>	Supply Current, Listen Mode	-	2.0	mA	
<a href="#">37</a>	Supply Current, Low Current Shutdown Mode	-	50.0	$\mu$ A	
<a href="#">38</a>	Supply Current, Dominant	-	7.0	mA	
<a href="#">39</a>	Supply Current, Recessive	-	5.0	mA	
<a href="#">40</a>	CANH Leakage Current (Coldspare)	-25.0	25.0	$\mu$ A	
<a href="#">41</a>	CANL Leakage Current (Coldspare)	-25.0	25.0	$\mu$ A	
<a href="#">42</a>	VREF Leakage Current (Coldspare)	-25.0	25.0	$\mu$ A	
<a href="#">43</a>	Driver Propagation Delay, LOW to HIGH	-	160.0	ns	RS = 0V
<a href="#">44</a>	Driver Propagation Delay, LOW to HIGH	-	550.0	ns	RS = 10k
<a href="#">45</a>	Driver Propagation Delay, LOW to HIGH	-	800.0	ns	RS = 50k
<a href="#">46</a>	Driver Propagation Delay, HIGH to LOW	-	180.0	ns	RS = 0V
<a href="#">47</a>	Driver Propagation Delay, HIGH to LOW	-	650.0	ns	RS = 10k
<a href="#">48</a>	Driver Propagation Delay, HIGH to LOW	-	900.0	ns	RS = 50k
<a href="#">49</a>	Driver Output Skew	-	65.0	ns	RS = 0V
<a href="#">50</a>	Driver Output Skew	-	275.0	ns	RS = 10k
<a href="#">51</a>	Driver Output Skew	-	400.0	ns	RS = 50k
<a href="#">52</a>	Driver Output Rise time	15.0	85.0	ns	RS = 0V
<a href="#">53</a>	Driver Output Fall time	10.0	65.0	ns	RS = 0V
<a href="#">54</a>	Total Loop Delay, Dominant to Recessive	-	285.0	ns	RS = 0V
<a href="#">55</a>	Total Loop Delay, Dominant to Recessive	-	750.0	ns	RS = 10k
<a href="#">56</a>	Total Loop Delay, Dominant to Recessive	-	950.0	ns	RS = 50k
<a href="#">57</a>	Total Loop Delay, Recessive to Dominant	-	225.0	ns	RS = 0V
<a href="#">58</a>	Total Loop Delay, Recessive to Dominant	-	600.0	ns	RS = 10k
<a href="#">59</a>	Total Loop Delay, Recessive to Dominant	-	800.0	ns	RS = 50k
<a href="#">60</a>	Receiver Propagation Delay, HIGH to LOW	-	110.0	ns	
<a href="#">61</a>	Receiver Propagation Delay, LOW to HIGH	-	110.0	ns	
<a href="#">62</a>	Receiver Skew	-	35.0	ns	
<a href="#">63</a>	Loopback Delay, IO to Receiver Output	-	90.0	ns	
<a href="#">64</a>	Loopback Delay, IO to Receiver Output	-	90.0	ns	
<a href="#">65</a>	VREF Pin Voltage	1.35	1.65	V	-5 $\mu$ A to 5 $\mu$ A
<a href="#">66</a>	VREF Pin Voltage	1.35	1.65	V	-5 $\mu$ A to 5 $\mu$ A
<a href="#">67</a>	VREF Pin Voltage	1.2	1.8	V	-50 $\mu$ A to 50 $\mu$ A
<a href="#">68</a>	VREF Pin Voltage	1.2	1.8	V	-50 $\mu$ A to 50 $\mu$ A
<a href="#">69</a>	RS Input Current, High Speed Mode	-10.0	-	$\mu$ A	
<a href="#">70</a>	RS Input Current, Listen Mode	-450.0	-	$\mu$ A	

Notes:

1. Limits are taken from Standard Microcircuit Drawing (SMD) 5962-15228.

## 5. Revision History

Rev.	Date	Description
0.00	Jul 12, 2017	Initial release

## IMPORTANT NOTICE AND DISCLAIMER

RENESAS ELECTRONICS CORPORATION AND ITS SUBSIDIARIES (“RENESAS”) PROVIDES TECHNICAL SPECIFICATIONS AND RELIABILITY DATA (INCLUDING DATASHEETS), DESIGN RESOURCES (INCLUDING REFERENCE DESIGNS), APPLICATION OR OTHER DESIGN ADVICE, WEB TOOLS, SAFETY INFORMATION, AND OTHER RESOURCES “AS IS” AND WITH ALL FAULTS, AND DISCLAIMS ALL WARRANTIES, EXPRESS OR IMPLIED, INCLUDING, WITHOUT LIMITATION, ANY IMPLIED WARRANTIES OF MERCHANTABILITY, FITNESS FOR A PARTICULAR PURPOSE, OR NON-INFRINGEMENT OF THIRD PARTY INTELLECTUAL PROPERTY RIGHTS.

These resources are intended for developers skilled in the art designing with Renesas products. You are solely responsible for (1) selecting the appropriate products for your application, (2) designing, validating, and testing your application, and (3) ensuring your application meets applicable standards, and any other safety, security, or other requirements. These resources are subject to change without notice. Renesas grants you permission to use these resources only for development of an application that uses Renesas products. Other reproduction or use of these resources is strictly prohibited. No license is granted to any other Renesas intellectual property or to any third party intellectual property. Renesas disclaims responsibility for, and you will fully indemnify Renesas and its representatives against, any claims, damages, costs, losses, or liabilities arising out of your use of these resources. Renesas' products are provided only subject to Renesas' Terms and Conditions of Sale or other applicable terms agreed to in writing. No use of any Renesas resources expands or otherwise alters any applicable warranties or warranty disclaimers for these products.

(Rev.1.0 Mar 2020)

### Corporate Headquarters

TOYOSU FORESIA, 3-2-24 Toyosu,  
Koto-ku, Tokyo 135-0061, Japan  
[www.renesas.com](http://www.renesas.com)

### Contact Information

For further information on a product, technology, the most up-to-date version of a document, or your nearest sales office, please visit:  
[www.renesas.com/contact/](http://www.renesas.com/contact/)

### Trademarks

Renesas and the Renesas logo are trademarks of Renesas Electronics Corporation. All trademarks and registered trademarks are the property of their respective owners.