

**Purpose** - This report describes the results of single event effects testing of the ISL7124SRH quad operational amplifier ('op amp') to determine whether this part meets the single-event transient (SET) design criterion of less than one volt perturbation of the output at an objective linear energy transfer (LET) value of 35 MeVcm<sup>2</sup>/mg. The ISL7124SRH is a hardened version of the popular '124' industry-standard single-supply operational amplifier. It is implemented in the hardened Intersil RSG process; the dielectrically isolated material used in this process eliminates single-event latchup and improves SET hardness.

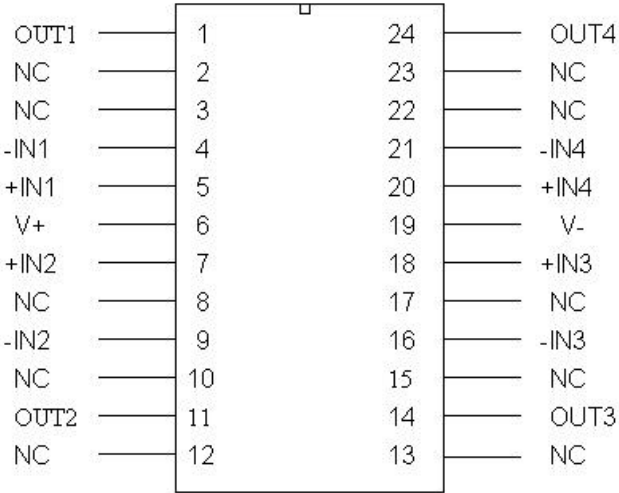
**Definition of Single Event Effects** - Single Event Effects (SEE) include any manifestation of circuit upset or disturbance induced by a single ion strike, including soft errors such as perturbation of the output of the amplifier or hard errors characterized by device latch up or burnout. In analog parts such as the ISL7124SRH, there are two SEE phenomena of interest. Single Event Latchup (SEL) is a potentially destructive phenomenon in which the die latches up, drawing excessive and potentially destructive supply current. Single Event Transient (SET) is a nondestructive phenomenon in which the part's output will show a positive or negative transient; if such a transient propagates to bistable circuitry in the system, an upset condition may result.

**Radiation Source** – The Cyclotron facility at Texas A&M University was used to provide heavy ions for this test. The SEE line is coupled to the K500 superconducting cyclotron and is capable of providing a wide range of test particles and energies for simulation of single events effects in the space environment. Beams can be delivered with a high degree of uniformity over a 2" x 2" cross sectional area. Uniformity is achieved by means of magnetic defocusing and scattering by thin foils. A degrader foil system makes it possible to set the desired beam LET value at a particular depth inside the target without changing the beam or rotating the target. The beam energy is reduced by means of a degrader foil having a suitable thickness and orientation with respect to the incident beam. It is possible at present to have three different foils in the holder at one time. Each foil can be inserted, withdrawn, and rotated remotely through use of computer controls, enabling testing at several LET levels without the need for accessing the test fixture directly.

**Instrumentation** – The instrumentation used to bias and monitor the devices under test included the following:

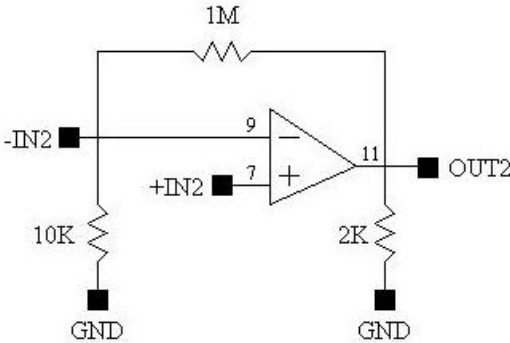
- 3 dc voltage meters to monitor amplifier output voltages.
- 2 dc current meters to monitor supply currents.
- 4-channel storage oscilloscope.
- 2 high-speed digital counters.
- Regulated power supplies for input and supply biasing.

**Units for Test-** Test devices were packaged in delidded 24 lead DIP packages to utilize existing test hardware (Figure 1).

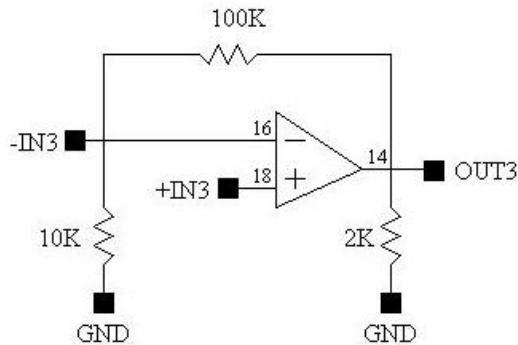


**Figure 1: ISL7124SRH SEE Package Pin Diagram**

**Test Methodology**– A test fixture was designed to configure two of the opamps in a closed loop gain configuration.



**Figure 2: Opamp 2 configured as a non-inverting amplifier with gain = 101.**



**Figure 3: Opamp 3 configured as a non-inverting amplifier with gain = 11.**

**Table 1: SEE bias conditions**

Bias cond	Vcc (V)	Vee (V)	IN2+ (V)	IN3+ (V)
A	15	-15	0.05	0.5
B	15	-15	0.1	1
C	7	0	0.02	0.15
D	7	0	0.03	0.3

Four bias conditions, shown in Table 1, were used to test the two device types at LET values of 40, 36 and 28 MeVcm<sup>2</sup>/mg. The opamp with a loop gain of 101 was used in each beam exposure to generate the triggering waveform for the storage oscilloscope. The oscilloscope trigger level was set at 100mV. The triggering level for both counters was set at a 500mV threshold. Use of the counters allowed an error rate to be measured and was used to derive the LET cross section. Counter 1 was used to monitor the x101 gain opamp and counter 2 was used to monitor the x11 opamp. The recorded output from the oscilloscope set at infinite persistence allows a visual record of the maximum perturbation of the output signal throughout the beam exposure.

Although the outputs to the oscilloscope were monitored at the test fixture inside the beam irradiation chamber, the outputs were connected to the test box through 6 feet

long coax cables having a capacitance of approximately 300pF to ground. There were also 2K ohm load resistors located at the outputs inside the test fixture to ground.

Due to time limitations and the number of bias conditions investigated, we were able to test only one sample of the ISL7124SRH.

Table 2 shows the data points taken with relevant information including the number of counts seen at the output of each amplifier.

Figures 6 and 7 show cross section vs. LET curves for amplifier gain configurations of 101 and 11, respectively.

Figures 8 through 20 represent output waveforms of the amplifiers under test at various bias conditions and LET values. This information is useful in quantifying the excursion of the output as a result of SEE induced upsets. Note that the SEE induced output excursion meets the design goal of 1V at a LET of 36 MeVcm<sup>2</sup>/mg. The indicated error voltage amplitude represents an improvement over previous LM124 test results.

**Table 2: ISL7124SRH SEU test data**

Bias cond	Test unit	File	LET	Count 1	Count 2	Run
A	1	0	36	1476	1492	122
B	1	1	36	1613	1454	124
C	1	2	36	735	536	126
D	1	3	36	650	491	127
D	1	4	28	320	289	128
C	1	6	28	327	148	131
B	1	8	28	689	666	134
A	1	9	28	621	767	135
A	1	10	40	1383	1583	136
B	1	11	40	1555	1420	137
C	1	12	40	731	580	138
D	1	13	40	728	586	139

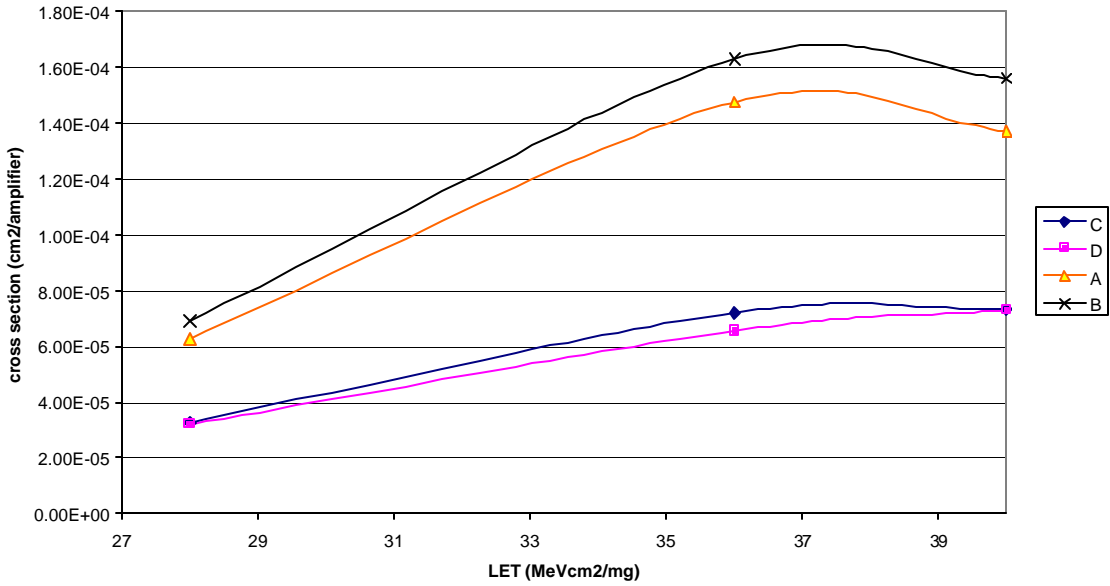


Figure 6: ISL7124SRH SEE Cross Section (gain=101) for bias conditions A – D.

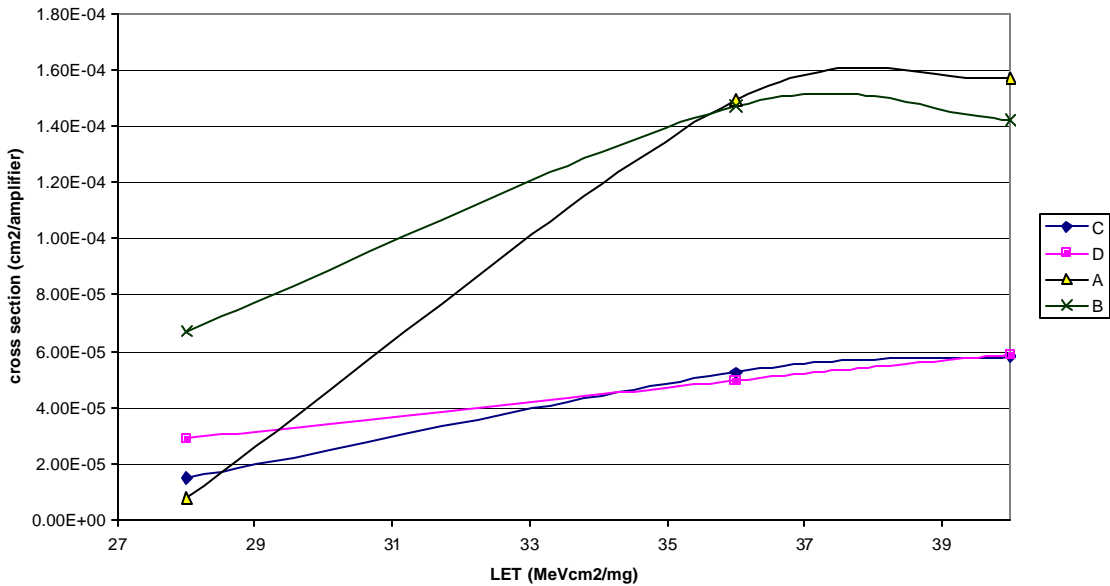
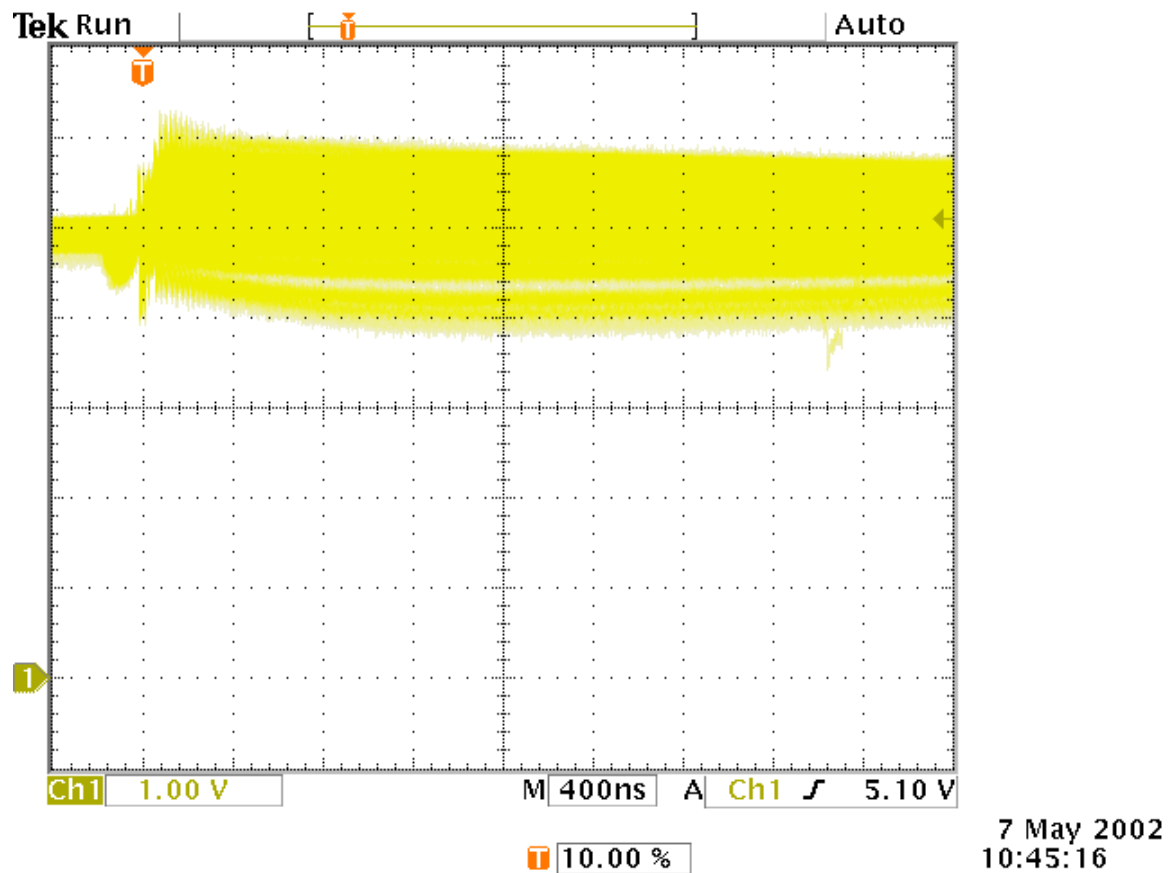
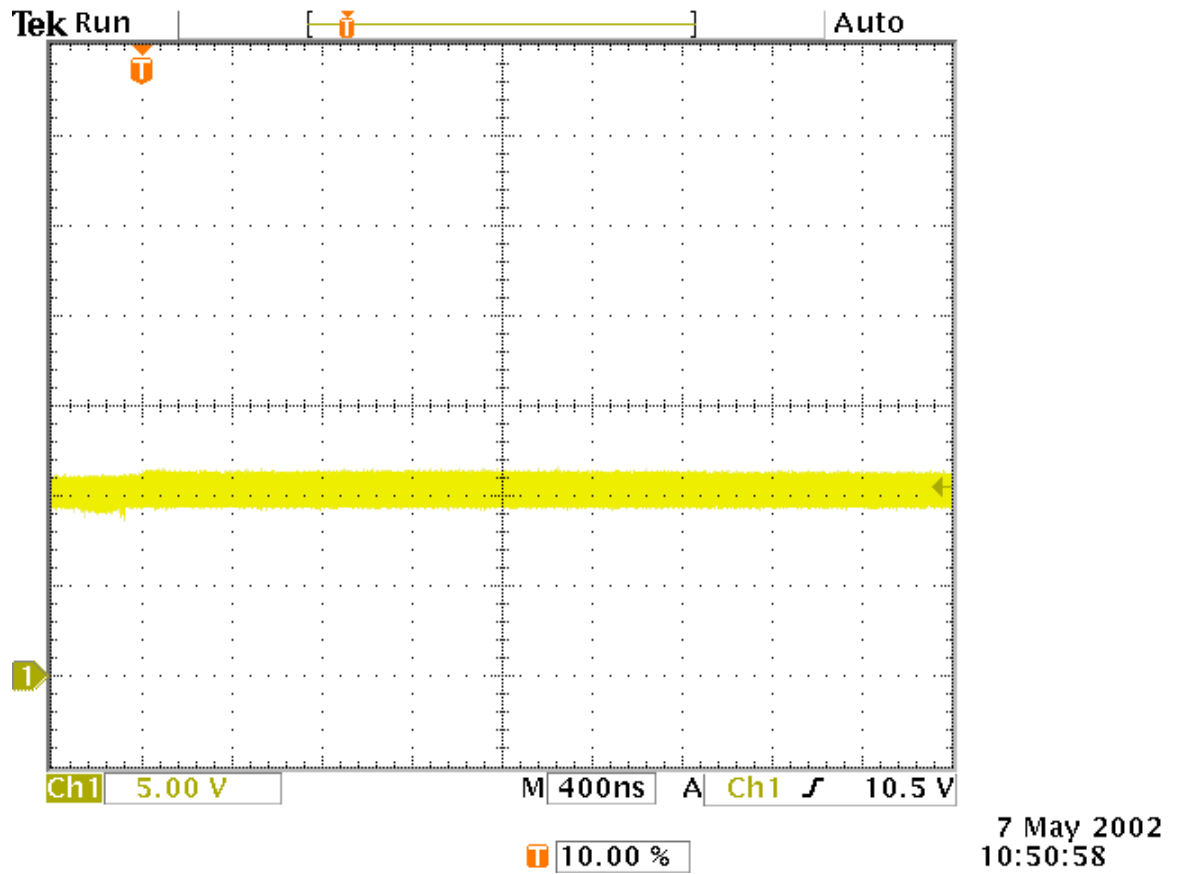


Figure 7: ISL7124SRH SEE Cross Section (gain=11) for bias conditions A - D.



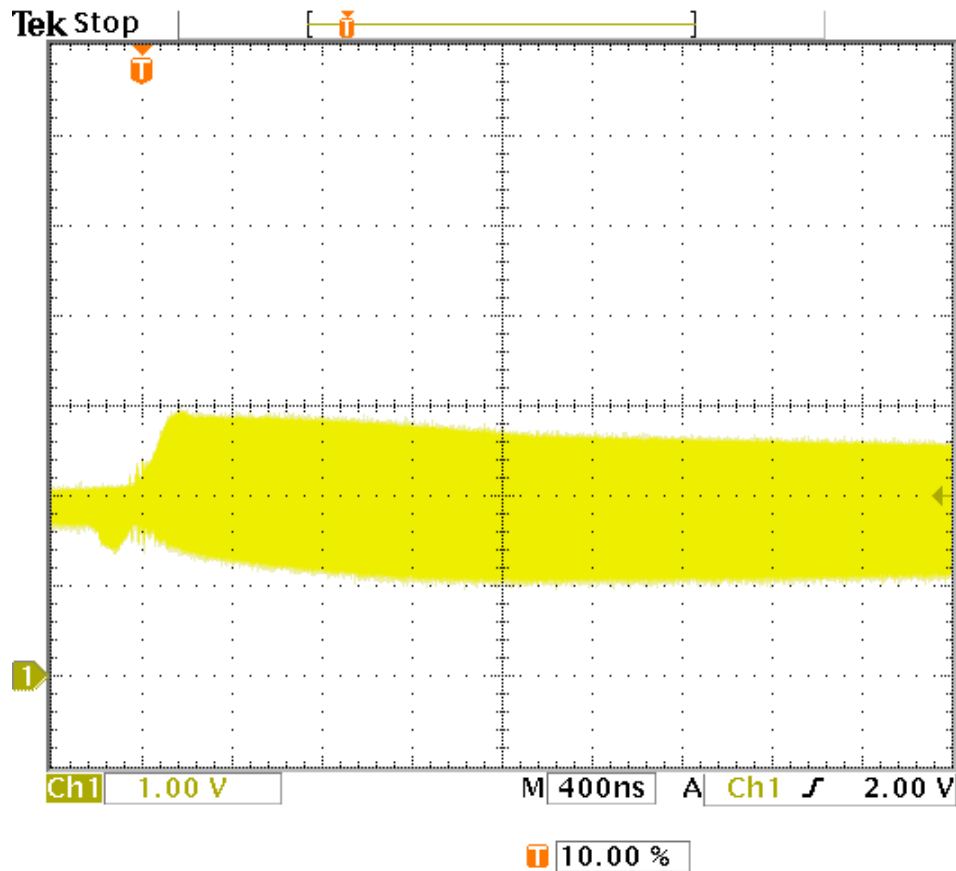
**Figure 8: ISL7124SRH SEE response using Kr, LET= 36MeV/mg.cm<sup>2</sup>.**

Gain = 101, Vcc = +15V, Vee = -15V and Vin = 50mV; output at 5.05V. Note SET transients of approximately 1V magnitude.



**Figure 9: ISL7124SRH SEE response using Kr, LET= 36MeV/mg.cm<sup>2</sup>.**

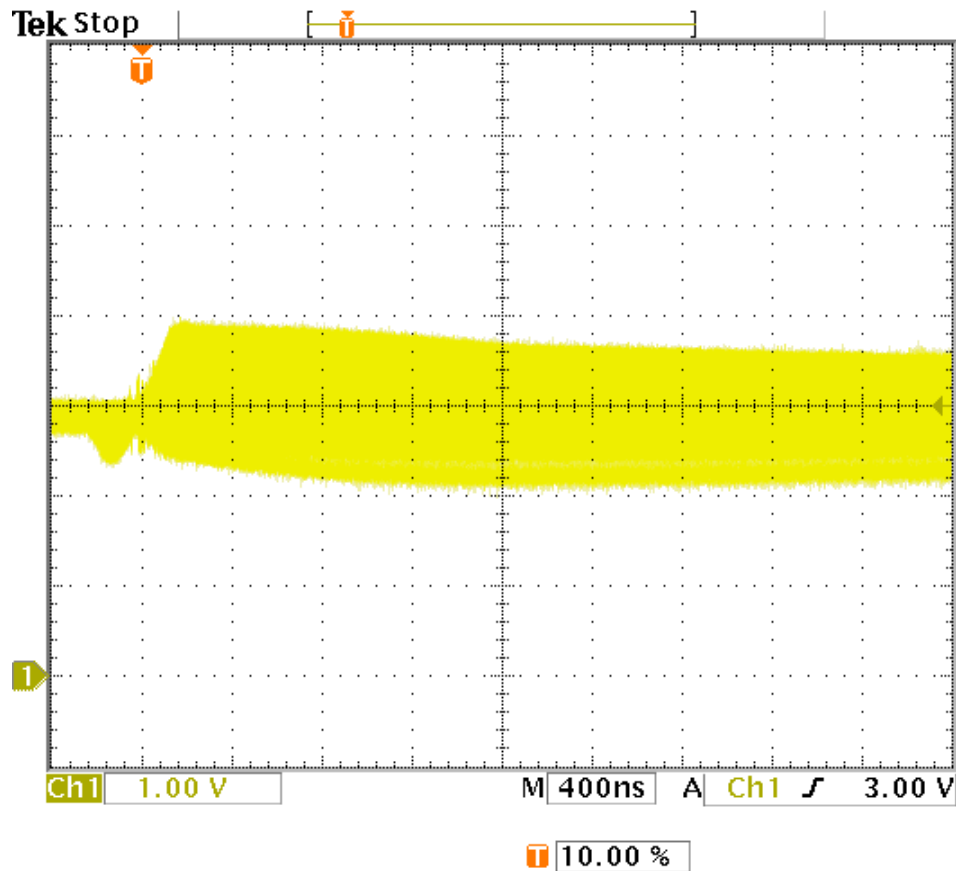
Gain = 101, Vcc = +15V, Vee = -15V and Vin = 100mV; output at 10.1V. Note lack of SET transients.



**Figure 10: ISL7124SRH SEE response using Kr, LET= 36MeV/mg.cm<sup>2</sup>.**

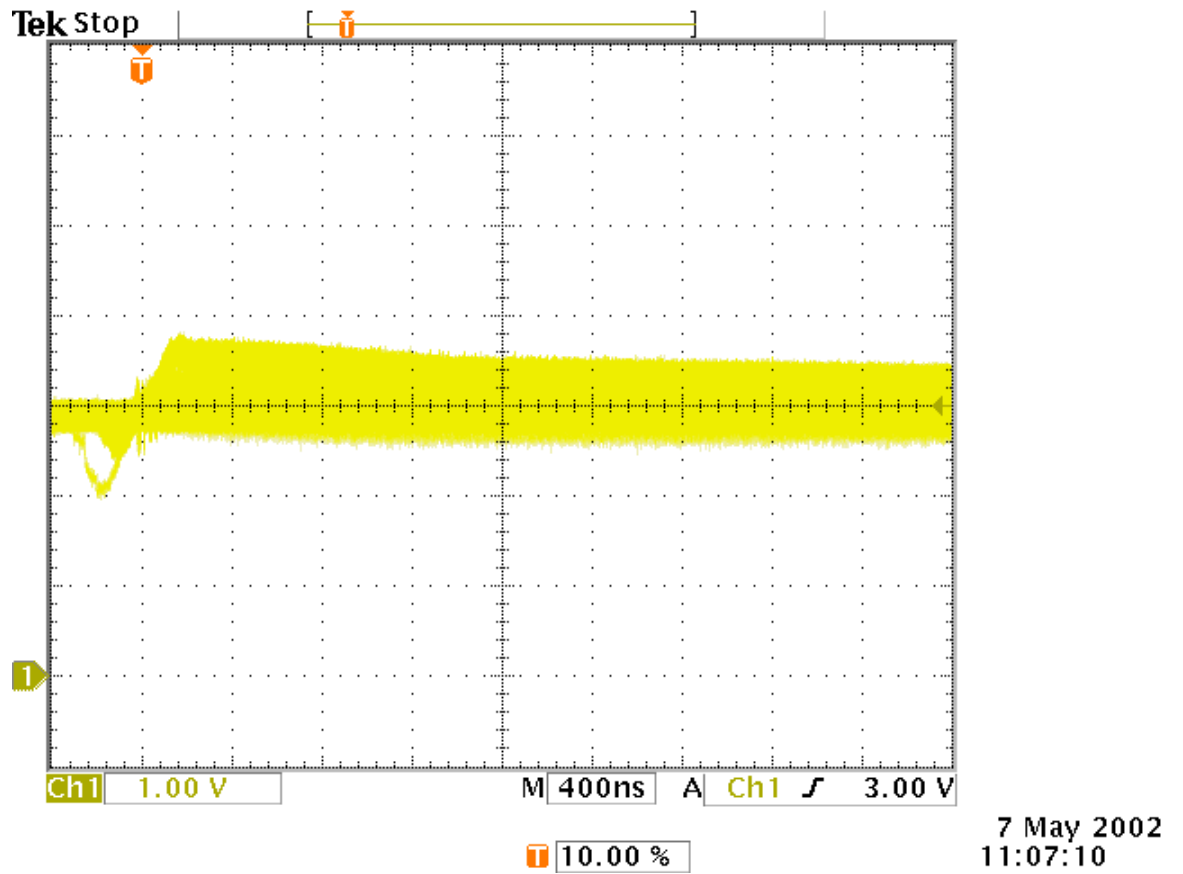
Gain = 101, Vcc = 7V, Vee = 0V and Vin = 20mV; output at 2.02V. Note SET transients of approximately 1V magnitude.





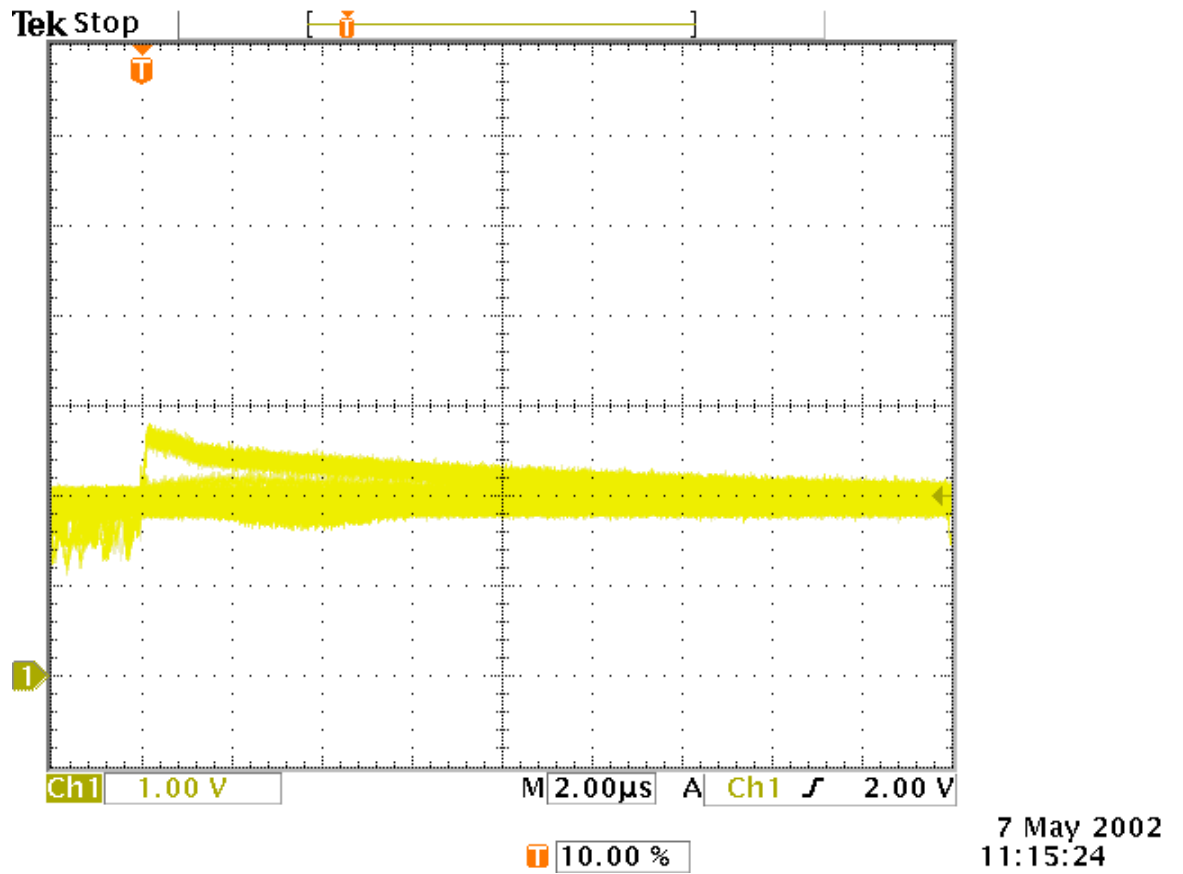
**Figure 11: ISL7124SRH SEE response using Kr, LET= 36MeV/mg.cm<sup>2</sup>.**

Gain = 101, V<sub>cc</sub> = 7V, V<sub>ee</sub> = 0V and V<sub>in</sub> = 30mV; output at 3.03V. Note SET transients of approximately 1V magnitude.



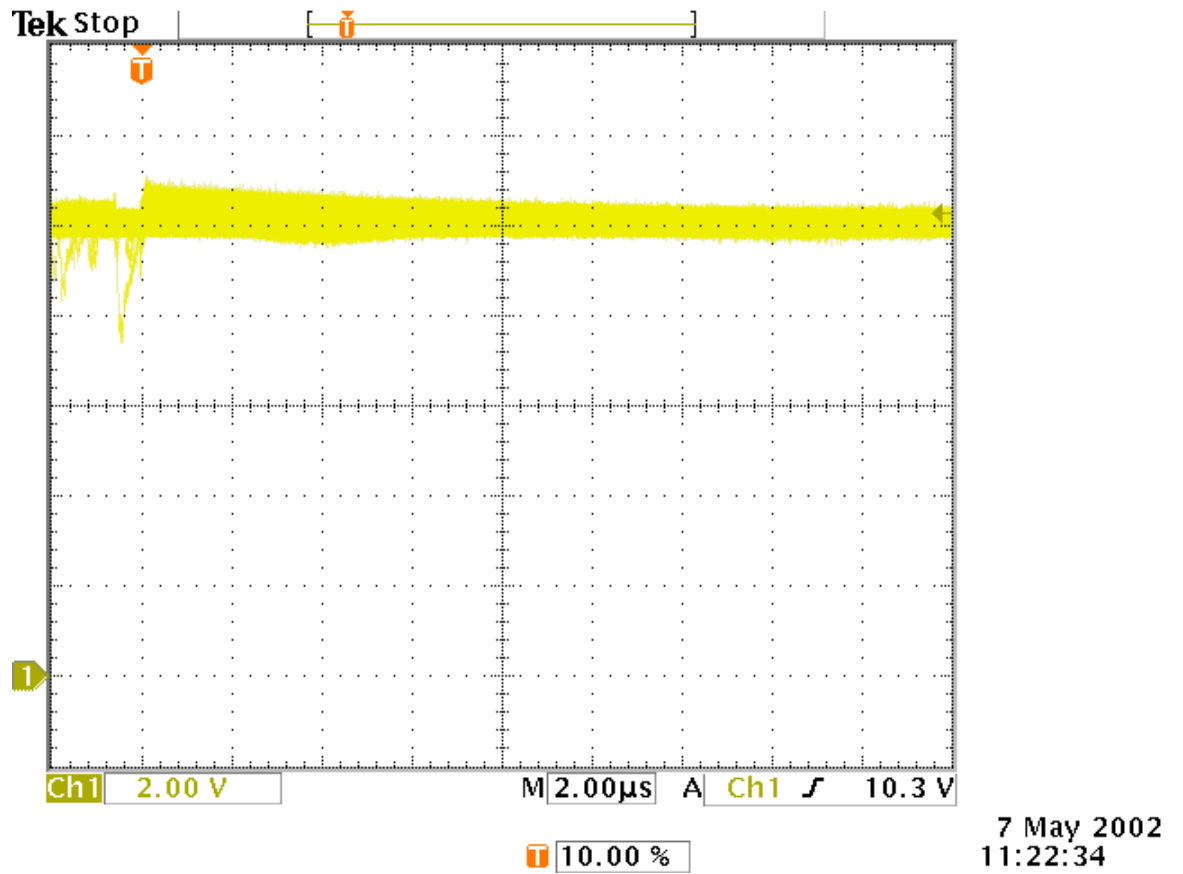
**Figure 12: ISL7124SRH SEE response using Kr, LET= 28MeV/mg.cm<sup>2</sup>.**

Gain = 101, V<sub>cc</sub> = 7V, V<sub>ee</sub> = 0V and V<sub>in</sub> = 30mV; output at 3.03V. Note SET transients of less than 1V magnitude.



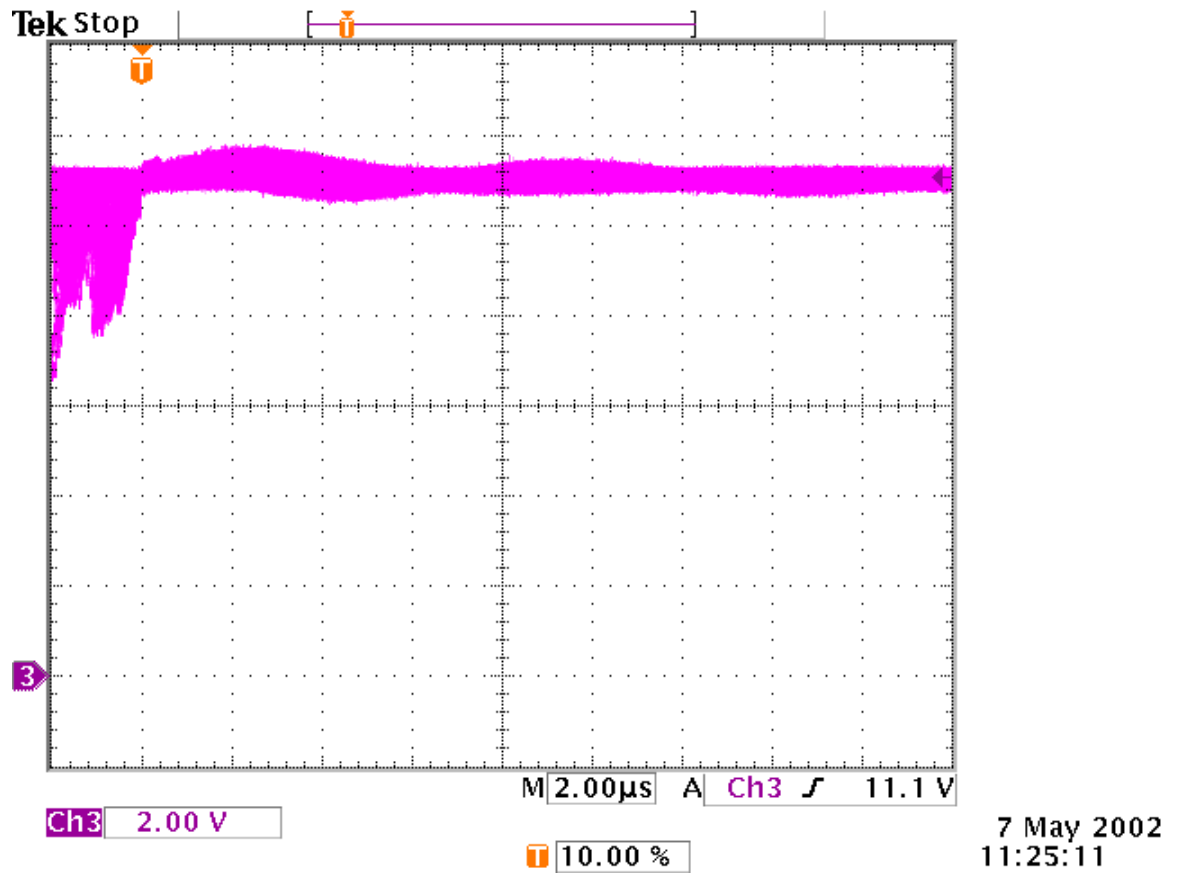
**Figure 13: ISL7124SRH SEE response using Kr, LET= 28MeV/mg.cm<sup>2</sup>.**

Gain = 101, V<sub>cc</sub> = 7V, V<sub>ee</sub> = 0V and V<sub>in</sub> = 20mV; output at 2.02V. Note SET transients of less than 1V magnitude.



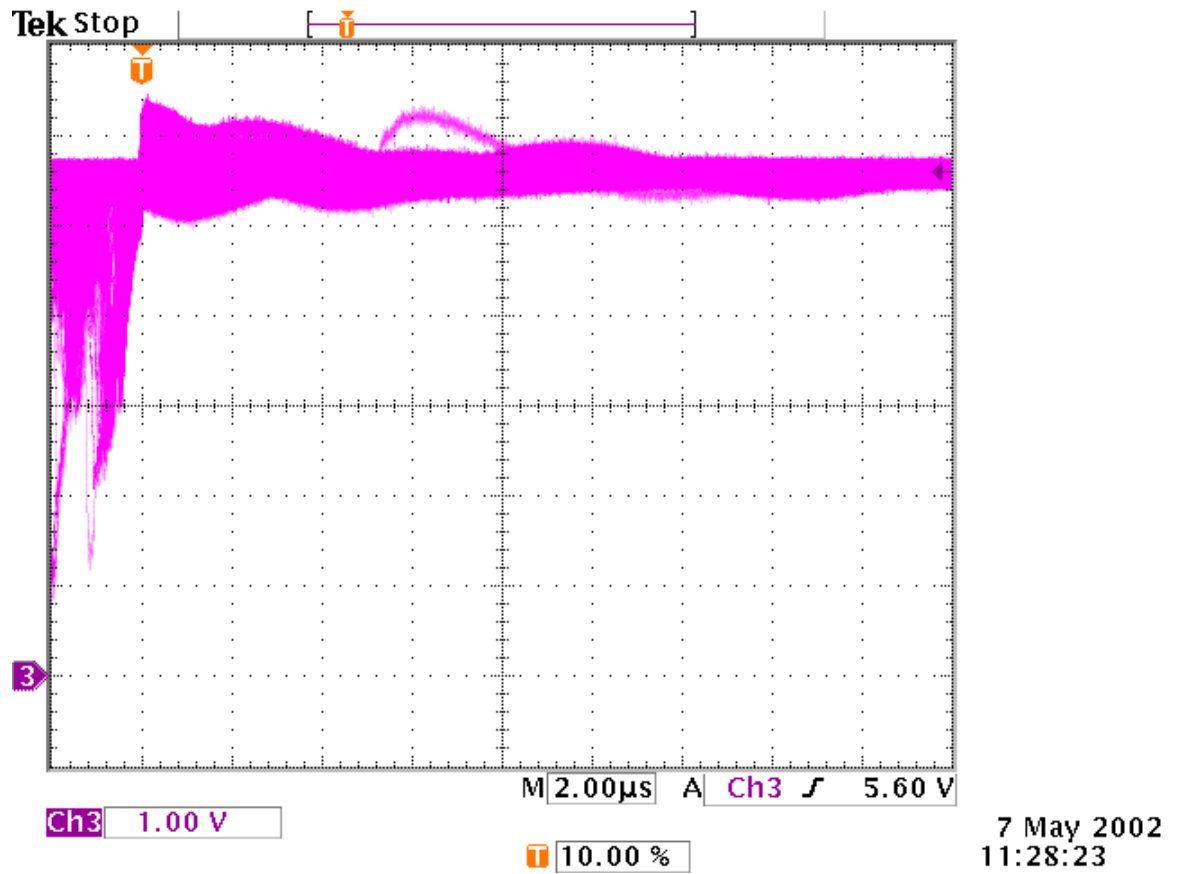
**Figure 14: ISL7124SRH SEE response using Kr, LET= 28MeV/mg.cm<sup>2</sup>.**

Gain = 101, Vcc = +15V, Vee = -15V and Vin = 100mV; output at 10.1V. Note SET transients of approximately 1V magnitude.



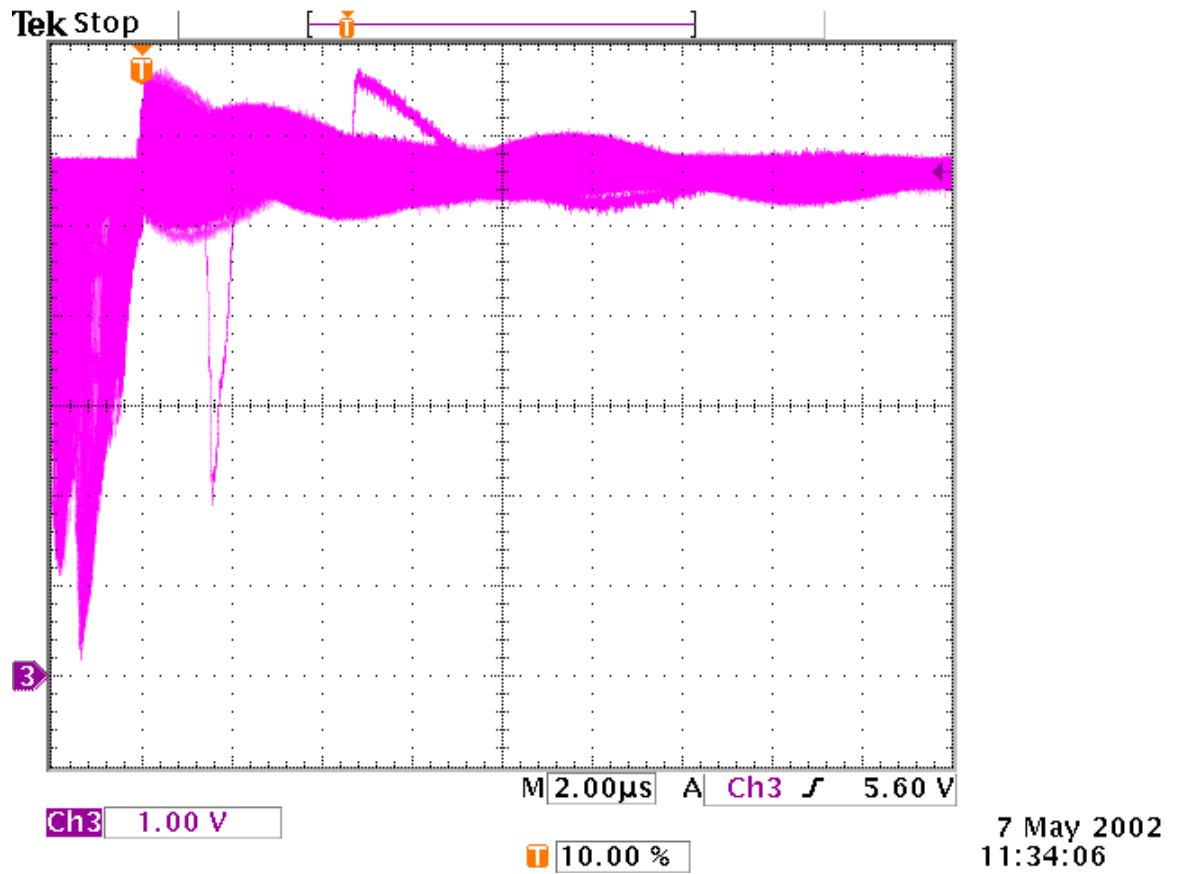
**Figure 15: ISL7124SRH SEE response using Kr, LET= 28MeV/mg.cm<sup>2</sup>.**

Gain = 11, V<sub>cc</sub> = +15V, V<sub>ee</sub> = -15V and V<sub>in</sub> = 1V; output at 11.1V. Note SET transients of less than 1V magnitude. The data waveform before the start of irradiation represents system noise.



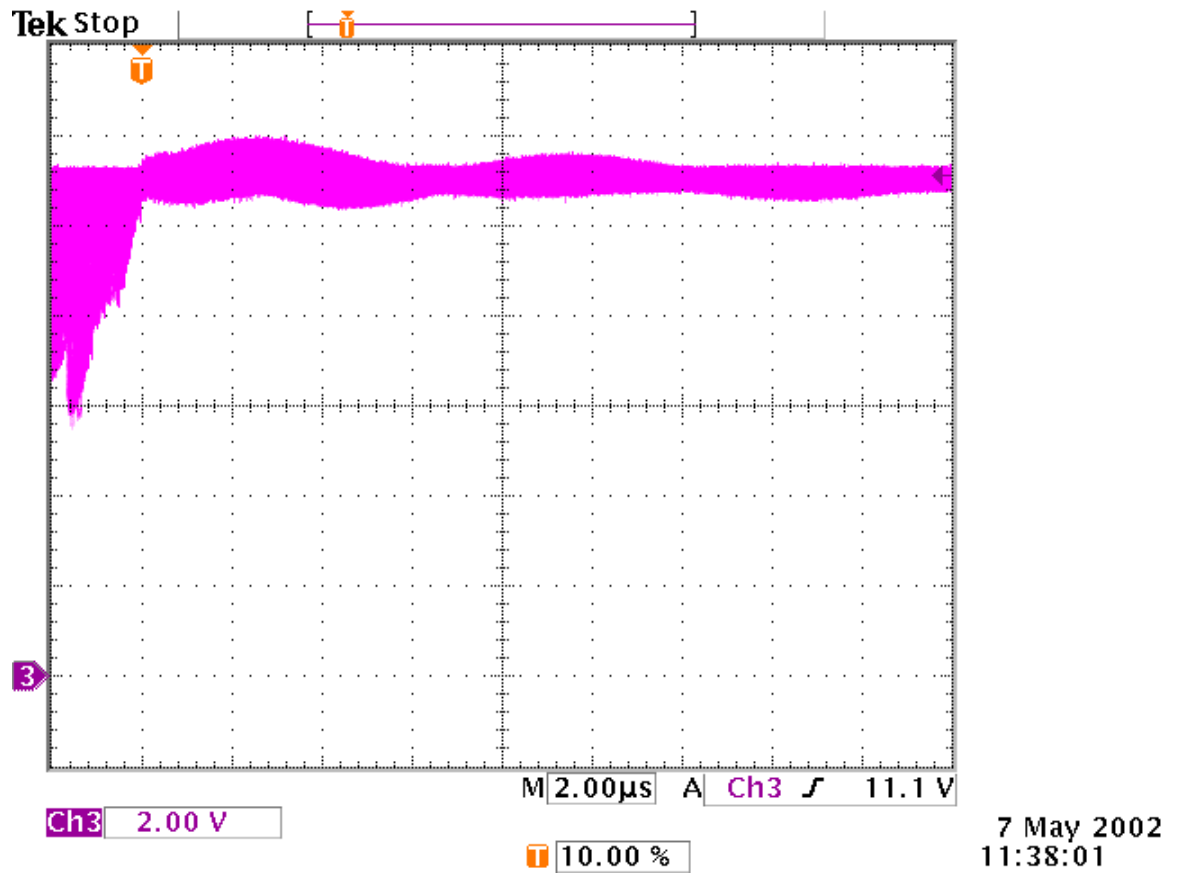
**Figure 16: ISL7124SRH SEE response using Kr, LET= 28MeV/mg.cm<sup>2</sup>.**

Gain = 11, Vcc = +15V, Vee = -15V and Vin = 500mV; output at 5.5V. Note SET transients of less than 1V magnitude. The data waveform before the start of irradiation represents system noise.



**Figure 17: ISL7124SRH SEE response using Kr, LET= 40MeV/mg.cm<sup>2</sup>.**

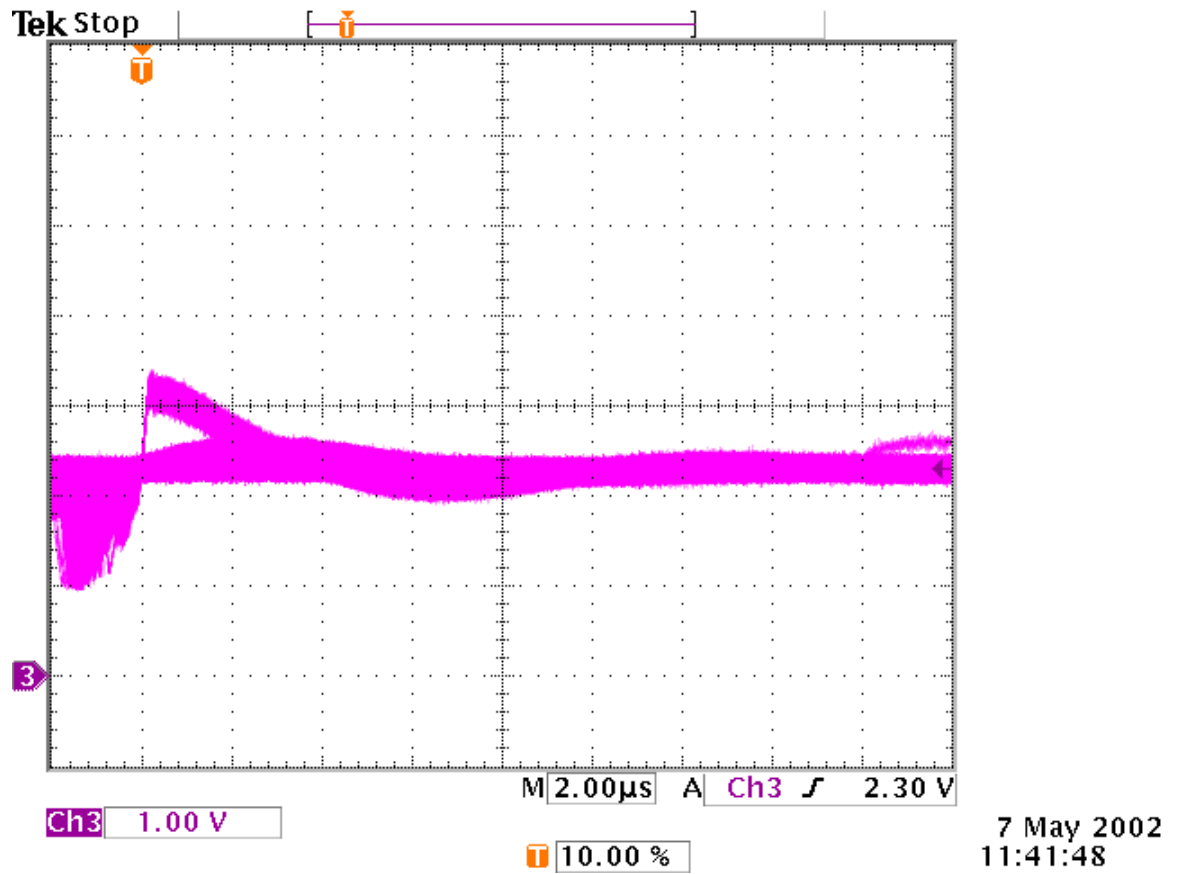
Gain = 11, Vcc = +15V, Vee = -15V and Vin = 500mV; output at 5.5V. Note SET transients of approximately 1V magnitude. The data waveform before the start of irradiation represents system noise.



**Figure 18: ISL7124SRH SEE response using Kr, LET= 40MeV/mg.cm<sup>2</sup>.**

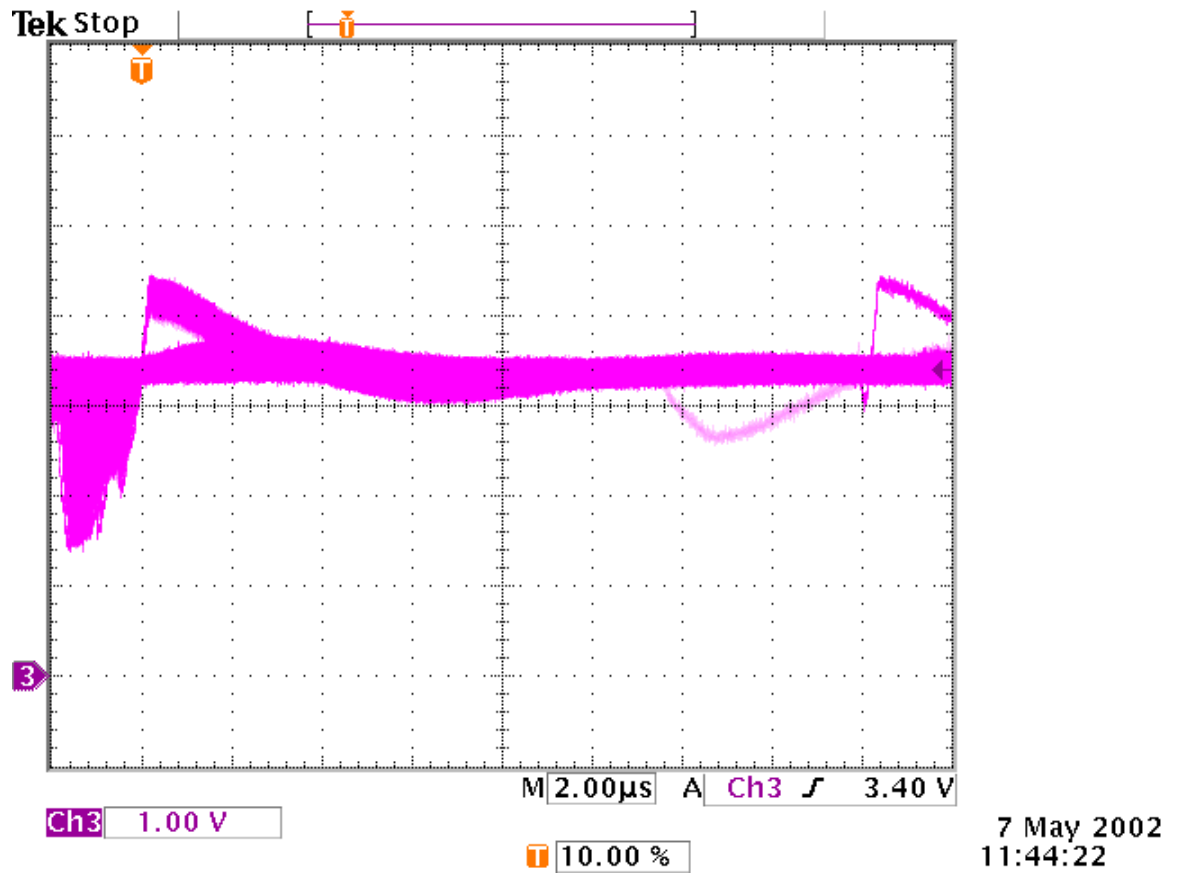
Gain = 11, Vcc = +15V, Vee = -15V and Vin = 1V; output at 11.1V. Note SET transients of less than 1V magnitude. The data waveform before the start of irradiation represents system noise.





**Figure 19: ISL7124SRH SEE response using Kr, LET= 40MeV/mg.cm<sup>2</sup>.**

Gain = 11, Vcc = 7V, Vee = 0V and Vin = 200mV; output at 2.2V. Note SET transients of approximately 1V magnitude. The data waveform before the start of irradiation represents system noise.



**Figure 20: ISL7124SRH SEE response using Kr, LET= 40MeV/mg.cm<sup>2</sup>.**

Gain = 11, Vcc = 7V, Vee = 0V and Vin = 300mV; output at 3.3V. Note SET transients of approximately 1V magnitude. The data waveform before the start of irradiation represents system noise.

**Conclusion** - Based on the results presented, the ISL7124SRH opamp offers some advantages over the competitor's part with respect to maximum SET output voltage excursion. No transient pulses greater than 2 volts were observed at LET levels up to 40 MeVcm<sup>2</sup>/mg. Both the voltage level and duration of transients were proportional to LET. The maximum transients at an LET of 36 MeVcm<sup>2</sup>/mg were observed to be very close to 1V with a typical duration no greater than 10 us compared to the design goal of 1V for 1us.

In order to put the data in perspective, a comparison of the ISL7124SRH test results described in this report and data from Poivey et al [1] for the commercial LM124 is shown in Table 3, below. The commercial part is seen to rail at a very low LET value in the gain=101 configuration, while the ISL7124SRH shows a maximum of 1V SET transient at an LET of 36MeVmg/cm<sup>2</sup>.

**Table 3: Comparison of SEE response of the ISL7124SRH and commercial 124**

Device	Gain	Vin	Vsupply	LET	SET voltage (V)	SET duration (us)
<b>LM124</b>	101	0.05	15/-15	2.86	Vcc rail	1.5
<b>ISL7124</b>	101	0.05	15/-15	36	1	>3
<b>LM124</b>	11	0.5	15/-15	30	2	>10
<b>ISL7124</b>	11	0.5	15/-15	40	1	>10

#### Reference

[1] Poivey, Christian et al., 'Development of a Test Methodology for Single-Event Transients (SETs) in Linear Devices', IEEE Trans. Nuc. Sci., Vol. 48, no. 6, December 2001.