

HS-26C31EH

Total Dose Testing

TR059  
Rev.0.00  
Jan 8, 2018

## Introduction

This report describes the results of Low Dose Rate (LDR) and High Dose Rate (HDR) total dose testing of the [HS-26C31EH](#) quad differential line driver. The data originated from routine production wafer-by-wafer acceptance testing of the part.

Two versions of the base HS-26C31 are available. The HS-26C31RH is acceptance tested on a wafer-by-wafer basis to 300krad(Si) at HDR only, as defined in MIL-STD-883 test method 1019 (50–300rad(Si)/s). The HS-26C31EH is acceptance tested on a wafer-by-wafer basis to 300krad(Si) at high dose rate and to 50krad(Si) at LDR, also as defined in MIL-STD-883 test method 1019 (0.01rad(Si)/s maximum). The HS-26C31RH and HS-26C31EH are identical parts and differ only in radiation lot acceptance testing (RLAT) procedures.

## Product Description

The HS-26C31RH and HS-26C31EH are radiation hardened quad differential line drivers designed for digital data transmission over balanced lines in low voltage RS-422 protocol applications. The use of a CMOS process ensures low power consumption, high speed, and reliable operation in the most severe radiation environments. The HS-26C31RH and HS-26C31EH accept CMOS level inputs and convert them to differential outputs. Enable pins allow several devices to be connected to the same data source and addressed independently. These devices have unique outputs that revert to a high impedance state when the driver is disabled or powered down, maintaining signal integrity in multi-driver applications.

Specifications for Rad Hard QML devices are controlled by the Defense Logistics Agency, Land and Maritime (DLA). The SMD number listed in this report must be used when ordering. Detailed electrical specifications for these devices are contained in SMD [5962-96663](#).

## Related Literature

- MIL-STD-883G test method 1019.7
- For a full list of related documents, visit our website
  - [HS-26C31EH](#) product page

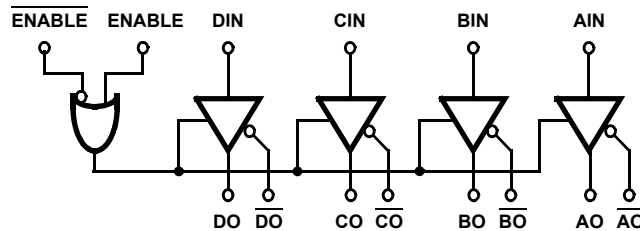

Figure 1. HS-26C31EH Block Diagram

## 1. Test Description

### 1.1 Irradiation Facilities

All data was derived from wafer acceptance testing results. HDR irradiation was performed using a Gammacell industry standard irradiator located in the Palm Bay, Florida Intersil facility. LDR irradiation was performed using the Intersil Palm Bay Hopewell Designs N40 panoramic irradiator located in the same facility. The HDR irradiations were performed at 55rad(Si)/s and the LDR irradiations were performed at 0.010rad(Si)/s.

### 1.2 Test Fixturing

[Figure 2](#) shows the configuration used for biased irradiation.

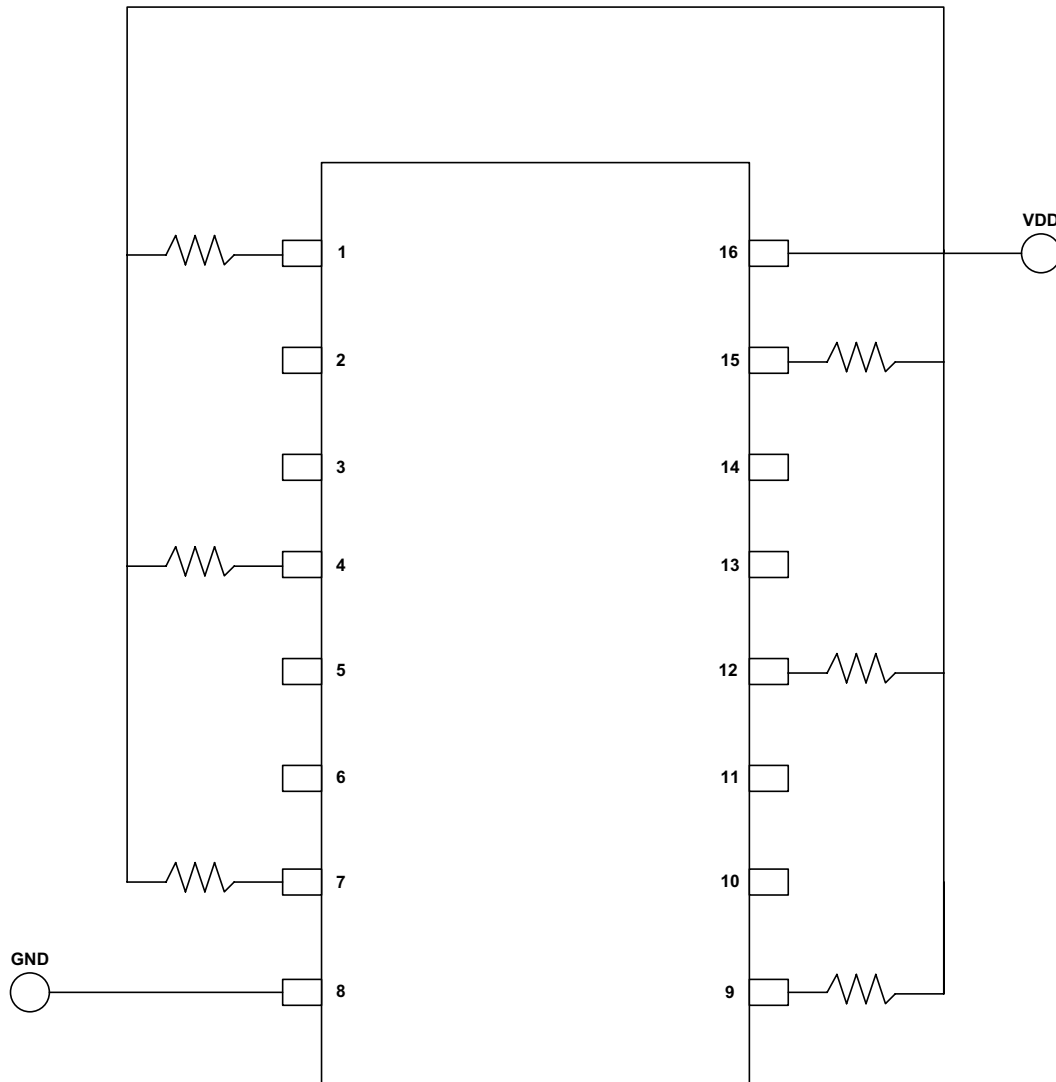

Figure 2. Irradiation Bias Configuration

Notes:

1. VDD = +5V  $\pm$  5%
2. GND = ground
3. All resistors are 47k $\Omega$   $\pm$  5%
4. Use generic 16-pin universal board
5. Use patch labeled HS26C31

### 1.3 Characterization Equipment and Procedures

All electrical testing was performed outside the irradiator using the production Automated Test Equipment (ATE) with datalogging at each downpoint. Downpoint electrical testing was performed at room temperature.

### 1.4 Experimental Matrix

The experimental matrix consisted of 48 samples irradiated at HDR under bias, 20 samples irradiated at LDR with all pins grounded, and 20 samples irradiated at LDR under bias. All samples were part of the wafer-by-wafer acceptance testing procedure.

Samples of the HS-26C31EH die were drawn from production lot G2A0PEH and were packaged in the standard hermetic 16-Ld solder-sealed flatpack (CDFP4-F16) production package. Samples were processed through the standard burn-in cycle before irradiation, as required by MIL-STD-883, and were screened to the SMD 5962-96663 limits at room, high, and low temperatures before the test.

### 1.5 Downpoints

Downpoints were zero and 300krad(Si) for the HDR test. Downpoints were zero, 50krad(Si), 100krad(Si), and 150krad(Si) for the LDR test.

## 2. Results

### 2.1 Attributes Data

Testing of the HS-26C31EH at both dose rates showed no rejected devices after irradiation, screening to the SMD pre-irradiation and post-irradiation limits. The SMD specifies that the part will meet all pre-irradiation limits post-irradiation, that is, the pre-irradiation and post-irradiation limits are the same. Calculations to determine any LDR sensitivity were not required because no rejects occurred in the pre-irradiation Group A limits. Accordingly, the part is considered ELDRS-free up to 150krad(Si), and this conclusion is further supported by referring to the variables data plots in the [Variables Data](#) section. No bias sensitivity was noted in the LDR data.

**Table 1. HS-26C31EH Total Dose Testing Attributes Data**

Dose Rate	Bias	Sample Size	Downpoint	Bin 1 ( <a href="#">Note 6</a> )	Rejects
0.01rad(Si)/s	<a href="#">Figure 2</a>	20	Pre-irradiation	20	
			50krad(Si)	20	0
			100krad(Si)	20	0
			150krad(Si)	20	0
0.01rad(Si)/s	Grounded	20	Pre-irradiation	20	
			50krad(Si)	20	0
			100krad(Si)	20	0
			150krad(Si)	20	
55rad(Si)/s	<a href="#">Figure 2</a>	48	Pre-irradiation	48	
			300krad(Si)/s	48	

Note:

6. Bin 1 indicates a device that passes all pre-irradiation specification limits.

### 2.2 Variables Data

The plots in [Figures 3](#) through [17](#) show data at all downpoints. Most of the plots show the response of all four channels of the parameter of interest as a function of total dose for each of the three irradiation conditions. Note that min/max error bars are not provided for this data because the distributions were tight enough to render this unnecessary. Note also that results are shown for the OUT outputs only; the corresponding data for the OUT\_BAR outputs was so similar as to be indistinguishable and these plots were omitted for clarity. In nearly all cases the guardbanded ATE limits are shown instead of the SMD limits, because the ATE limits are used for the total dose acceptance tests. Both limits are given in the figure captions.

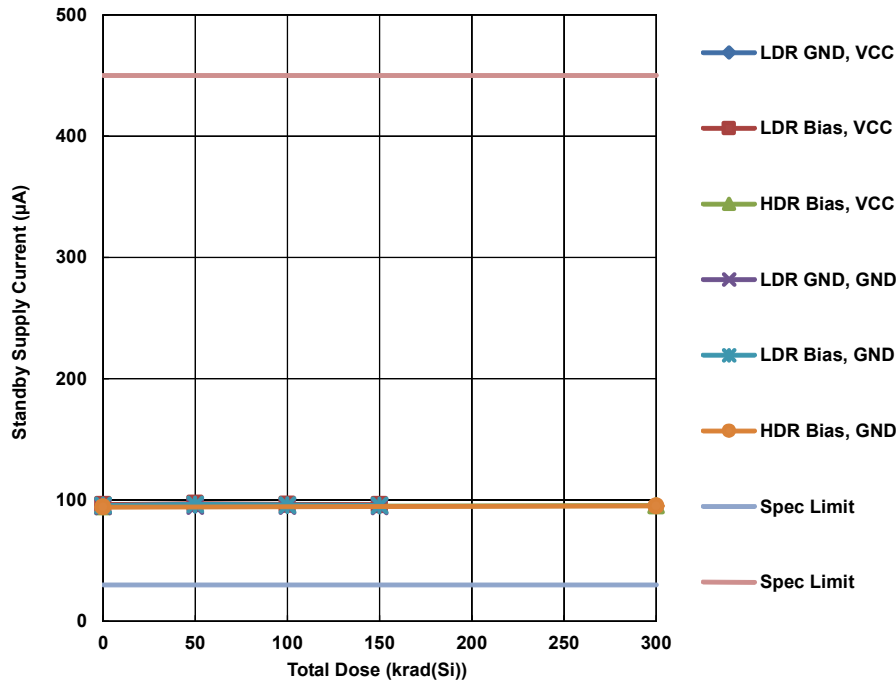

Figure 3. HS-26C31EH standby supply current, inputs at VCC or grounded, as a function of biased HDR total dose irradiation to 300krad(Si) and biased and unbiased (grounded) LDR irradiation to 150krad(Si). The sample size for the HDR cell was 48, while the sample sizes for the LDR cells were 20 each. The SMD limit is 500µA maximum; the internal ATE limits (shown) are 30µA to 450µA.

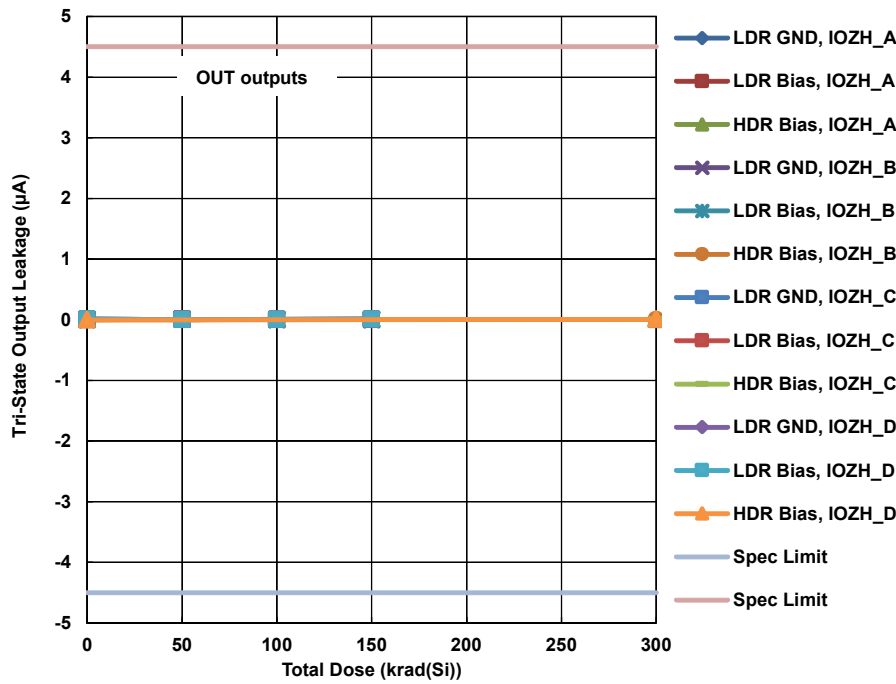

Figure 4. HS-26C31EH tristate output leakage, OUT outputs, channels A through D, as a function of biased HDR total dose irradiation to 300krad(Si) and biased and unbiased (grounded) LDR irradiation to 150krad(Si). The sample size for the HDR cell was 48, while the sample sizes for the LDR cells were 20 each. The SMD limits are -5µA to 5µA; the internal ATE limits (shown) are -4.5µA to 4.5µA.

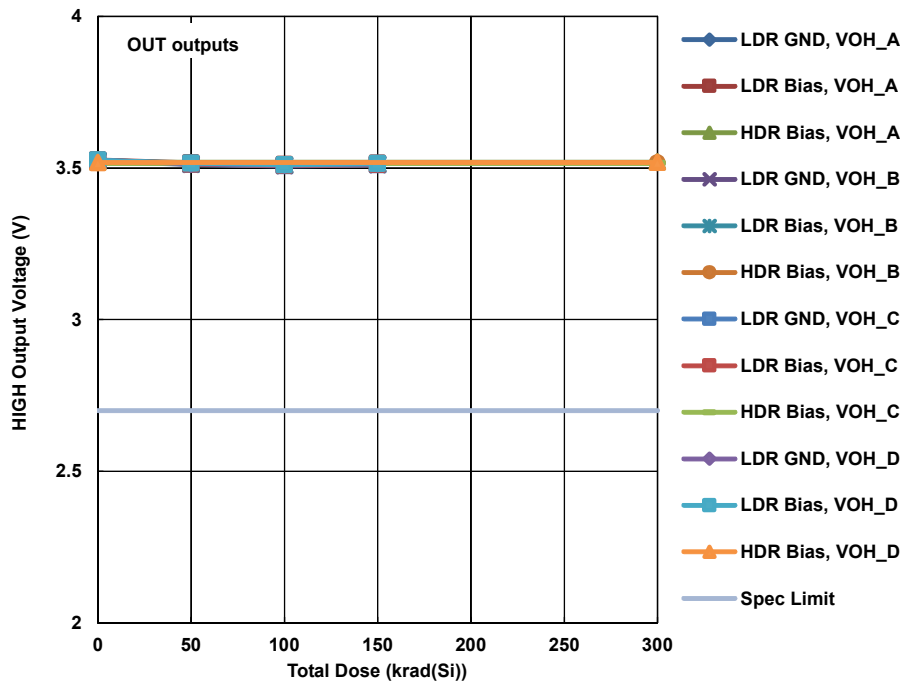

Figure 5. HS-26C31EH output HIGH voltage, OUT outputs, channels A through D, as a function of biased HDR total dose irradiation to 300krad(Si) and biased and unbiased (grounded) LDR irradiation to 150krad(Si). The sample size for the HDR cell was 48, while the sample sizes for the LDR cells were 20 each. The SMD limit is 2.5V minimum; the internal ATE limit (shown) is 2.7V minimum.

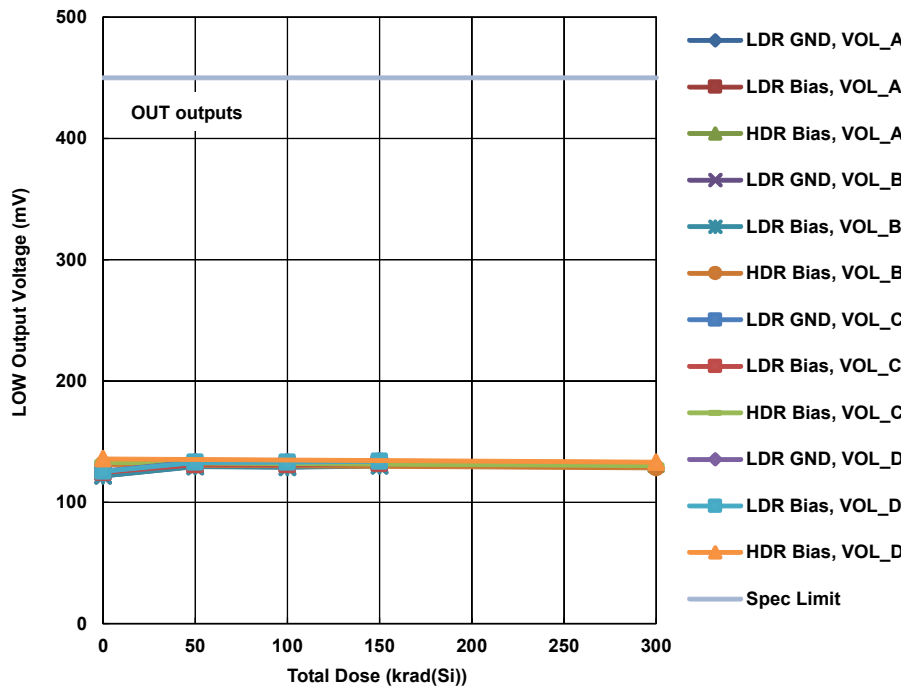

Figure 6. HS-26C31EH output LOW voltage, OUT outputs, channels A through D, as a function of biased HDR total dose irradiation to 300krad(Si) and biased and unbiased (grounded) LDR irradiation to 150krad(Si). The sample size for the HDR cell was 48, while the sample sizes for the LDR cells were 20 each. The SMD limit is 500mV maximum; the internal ATE limit (shown) is 450mV maximum.

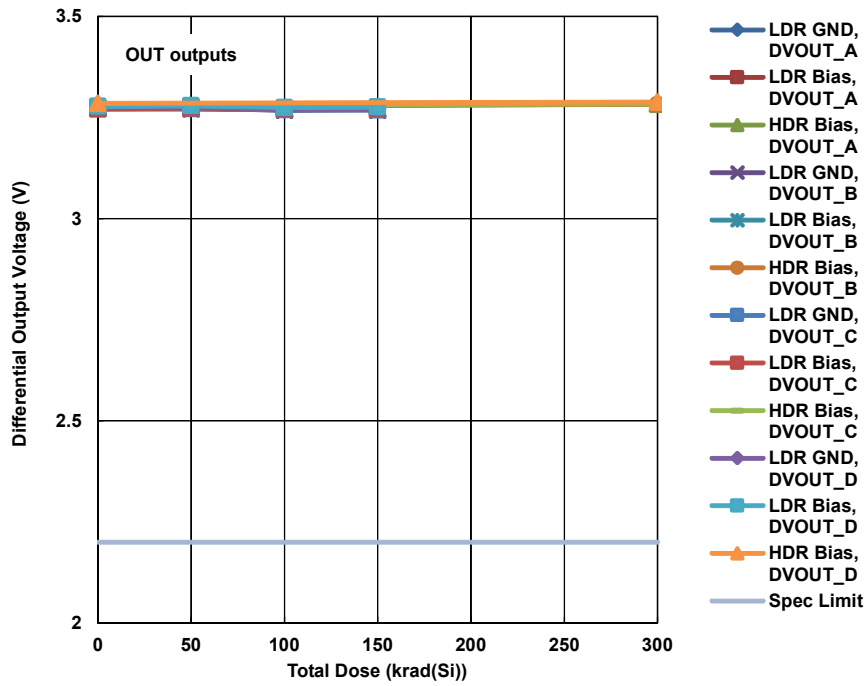

Figure 7. HS-26C31EH differential output voltage, OUT outputs, channels A through D, as a function of biased HDR total dose irradiation to 300krad(Si) and biased and unbiased (grounded) LDR irradiation to 150krad(Si). The sample size for the HDR cell was 48, while the sample sizes for the LDR cells were 20 each. The SMD limit is 2V minimum; the internal ATE limit (shown) is 2.2V minimum.

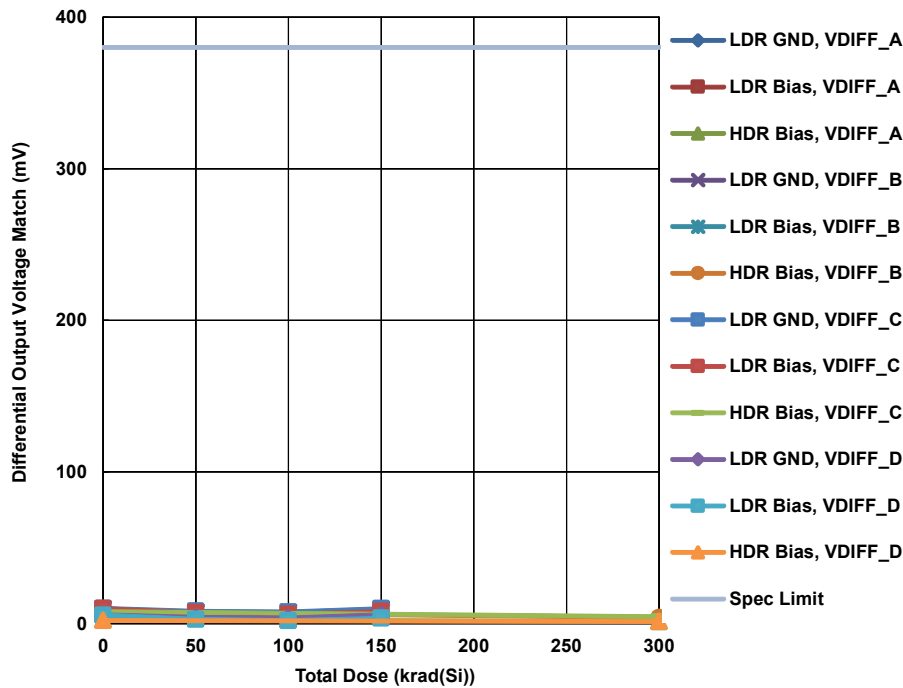

Figure 8. HS-26C31EH differential output voltage match, channels A through D, as a function of biased HDR total dose irradiation to 300krad(Si) and biased and unbiased (grounded) LDR irradiation to 150krad(Si). The sample size for the HDR cell was 48, while the sample sizes for the LDR cells were 20 each. The SMD limit is 400mV maximum; the internal ATE limit (shown) is 380mV maximum.

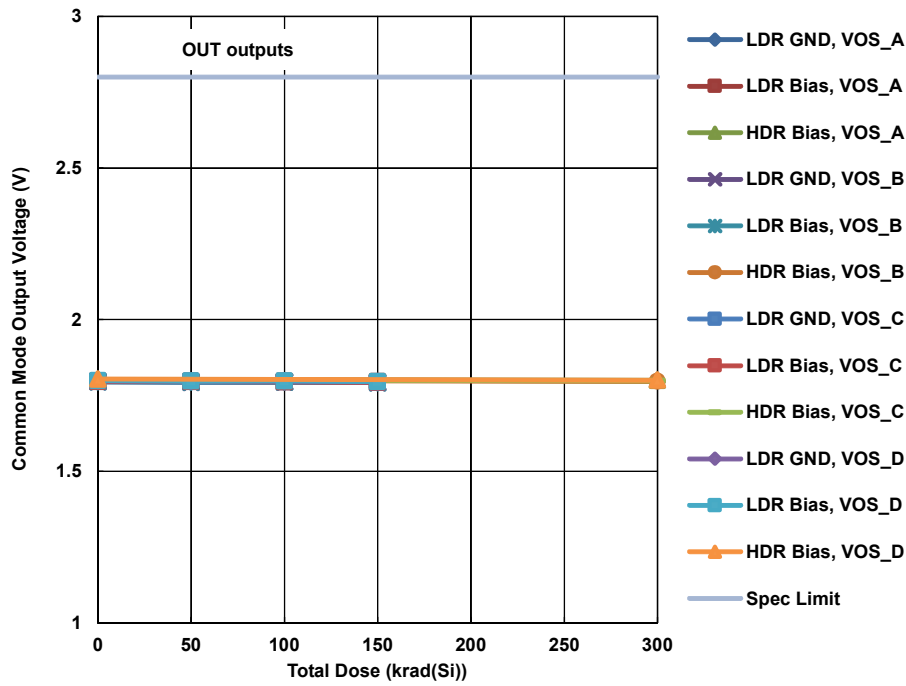

Figure 9. HS-26C31EH common mode output voltage, OUT outputs, channels A through D, as a function of biased HDR total dose irradiation to 300krad(Si) and biased and unbiased (grounded) LDR irradiation to 150krad(Si). The sample size for the HDR cell was 48, while the sample sizes for the LDR cells were 20 each. The SMD limit is 3V maximum; the internal ATE limit (shown) is 2.8V maximum.

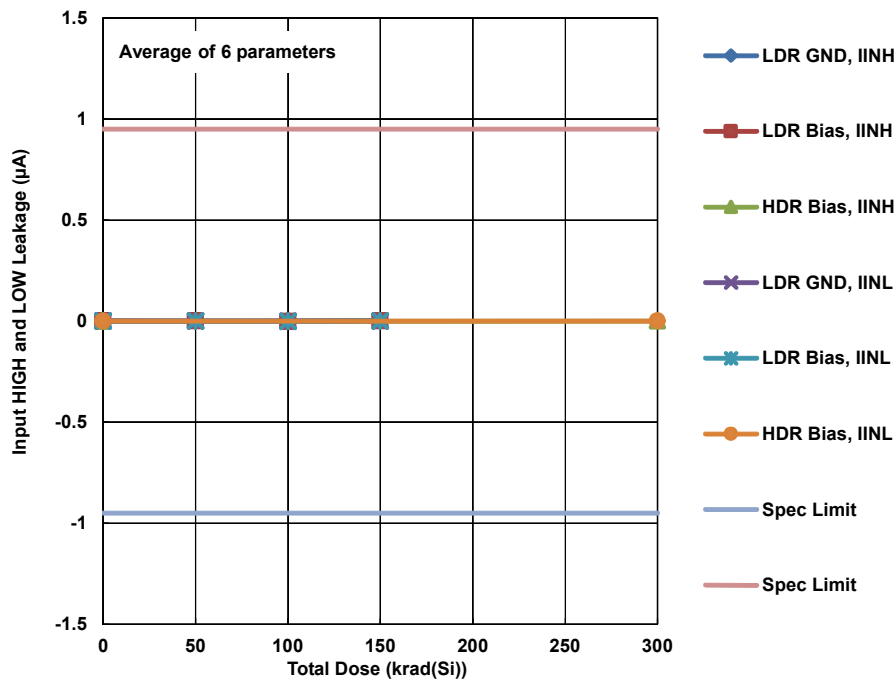

Figure 10. HS-26C31EH input HIGH and LOW leakage, average of channels A through D, ENABLE and ENABLE\_BAR, as a function of biased HDR total dose irradiation to 300krad(Si) and biased and unbiased (grounded) LDR irradiation to 150krad(Si). The sample size for the HDR cell was 48, while the sample sizes for the LDR cells were 20 each. The SMD limits are -1.0µA to +1.0µA; the internal ATE limits (shown) are -0.95µA to +0.95µA.



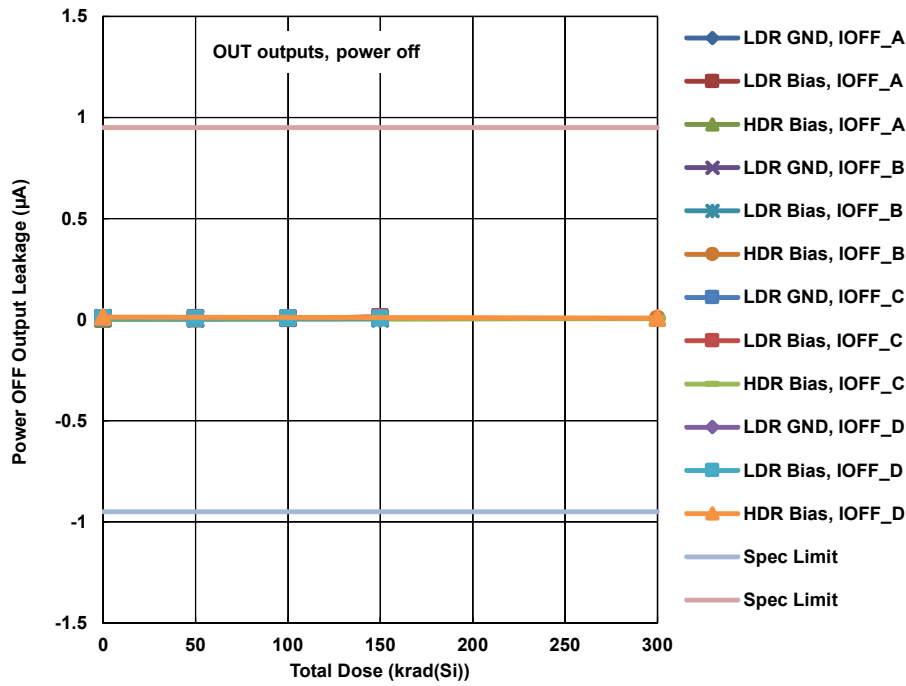

Figure 11. HS-26C31EH power OFF output leakage current, OUT outputs, channels A through D, as a function of biased HDR total dose irradiation to 300krad(Si) and biased and unbiased (grounded) LDR irradiation to 150krad(Si). The sample size for the HDR cell was 48, while the sample sizes for the LDR cells were 20 each. The SMD limits are -100µA to +100µA; the internal ATE limits (shown) are -95µA to +95µA.

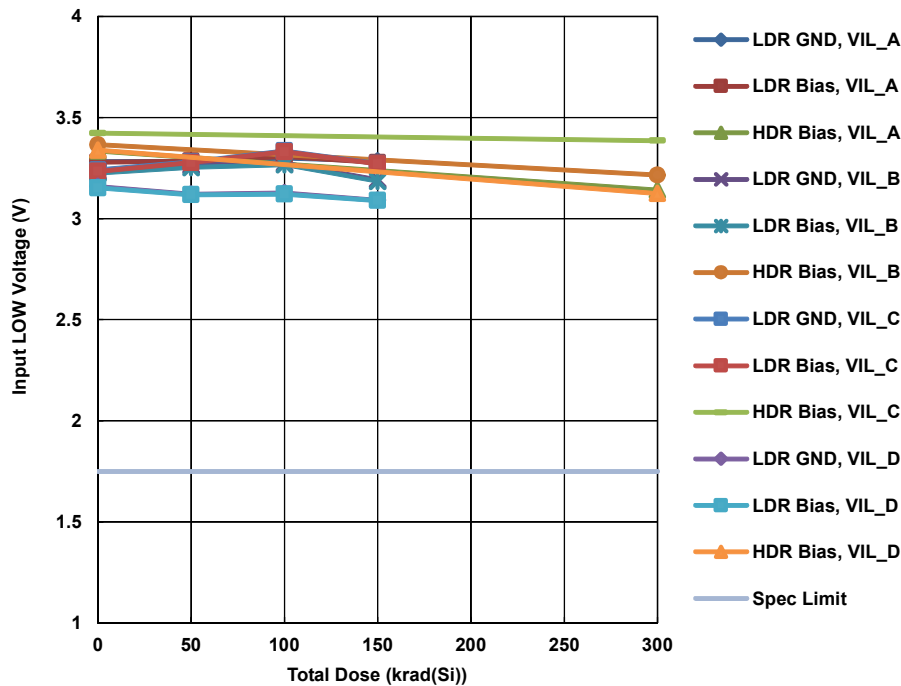

Figure 12. HS-26C31EH input LOW voltage, channels A through D, as a function of biased HDR total dose irradiation to 300krad(Si) and biased and unbiased (grounded) LDR irradiation to 150krad(Si). The sample size for the HDR cell was 48, while the sample sizes for the LDR cells were 20 each. The SMD limit is 1.75V minimum.

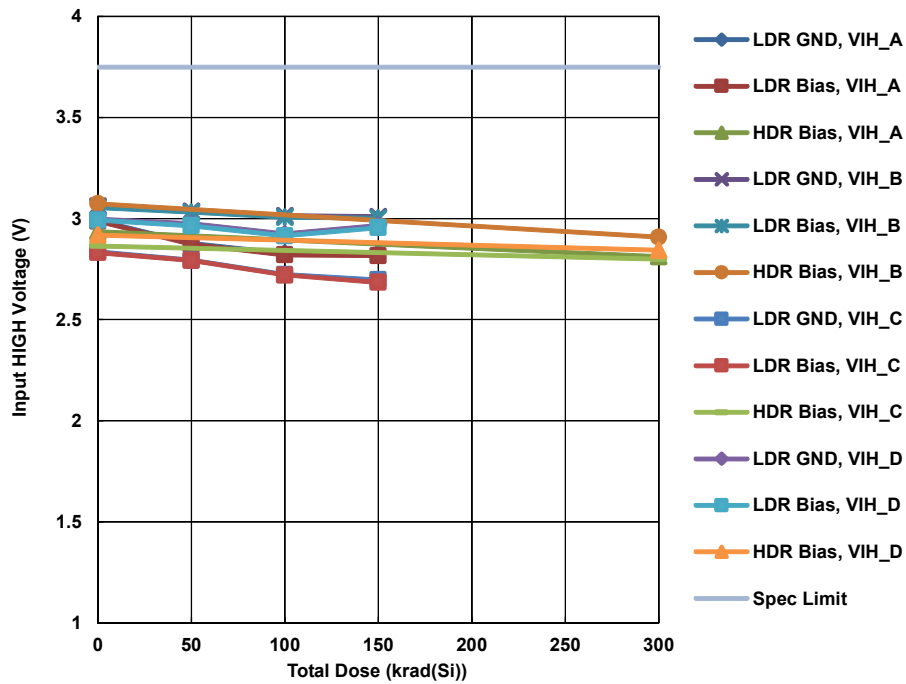

Figure 13. HS-26C31EH input HIGH voltage, channels A through D, as a function of biased HDR total dose irradiation to 300krad(Si) and biased and unbiased (grounded) LDR irradiation to 150krad(Si). The sample size for the HDR cell was 48, while the sample sizes for the LDR cells were 20 each. The SMD limit is 3.75V maximum.

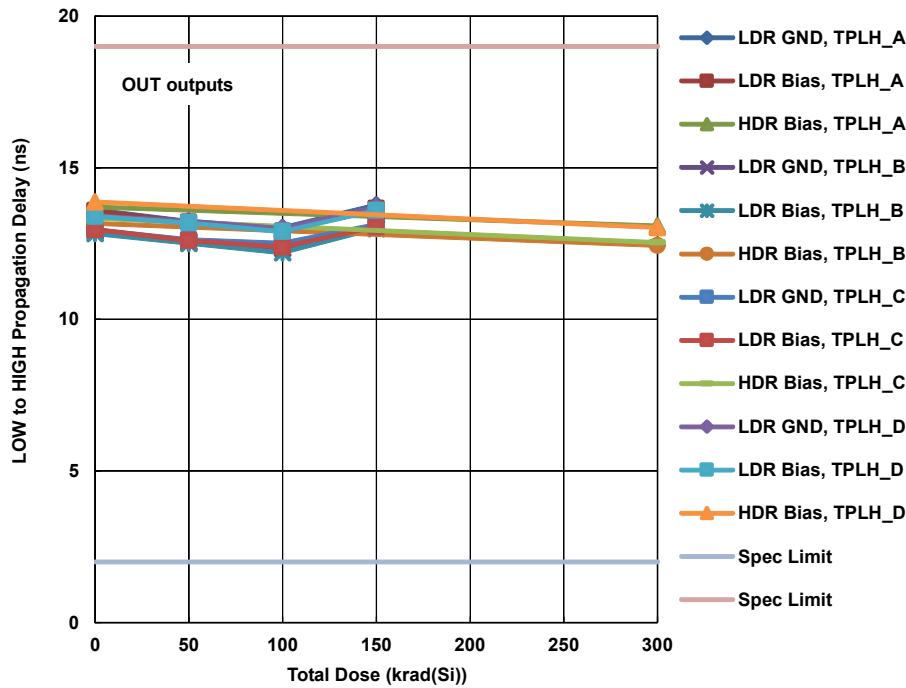

Figure 14. HS-26C31EH LOW to HIGH propagation delay, OUT outputs, channels A through D, as a function of biased HDR total dose irradiation to 300krad(Si) and biased and unbiased (grounded) LDR irradiation to 150krad(Si). The sample size for the HDR cell was 48, while the sample sizes for the LDR cells were 20 each. The SMD limits are 2ns to 22ns; the internal ATE limits (shown) are 2ns to 19ns.

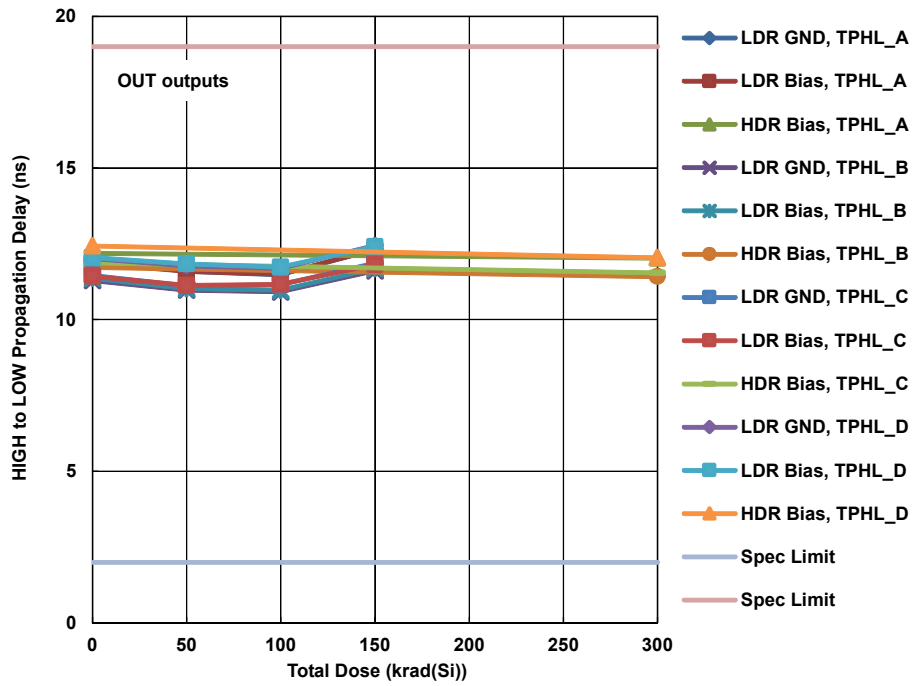

Figure 15. HS-26C31EH HIGH to LOW propagation delay, OUT outputs, channels A through D, as a function of biased HDR total dose irradiation to 300krad(Si) and biased and unbiased (grounded) LDR irradiation to 150krad(Si). The sample size for the HDR cell was 48, while the sample sizes for the LDR cells were 20 each. The SMD limits are 2ns to 22ns; the internal ATE limits (shown) are 2ns to 19ns.

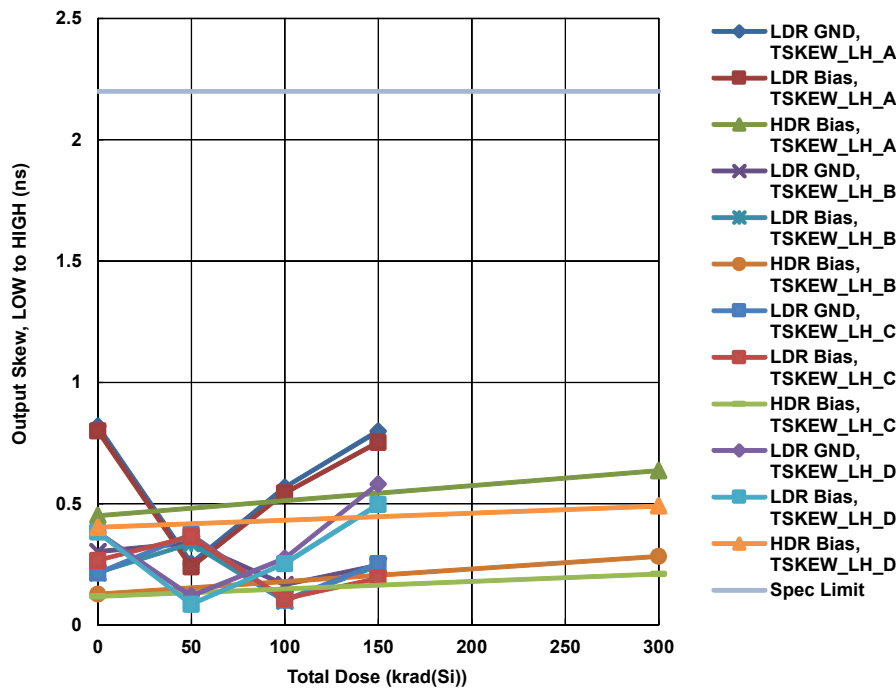

Figure 16. HS-26C31EH LOW to HIGH output skew, channels A through D, as a function of biased HDR total dose irradiation to 300krad(Si) and biased and unbiased (grounded) LDR irradiation to 150krad(Si). The sample size for the HDR cell was 48, while the sample sizes for the LDR cells were 20 each. The SMD limit is 3ns maximum; the internal ATE limit (shown) is 2.2ns maximum.

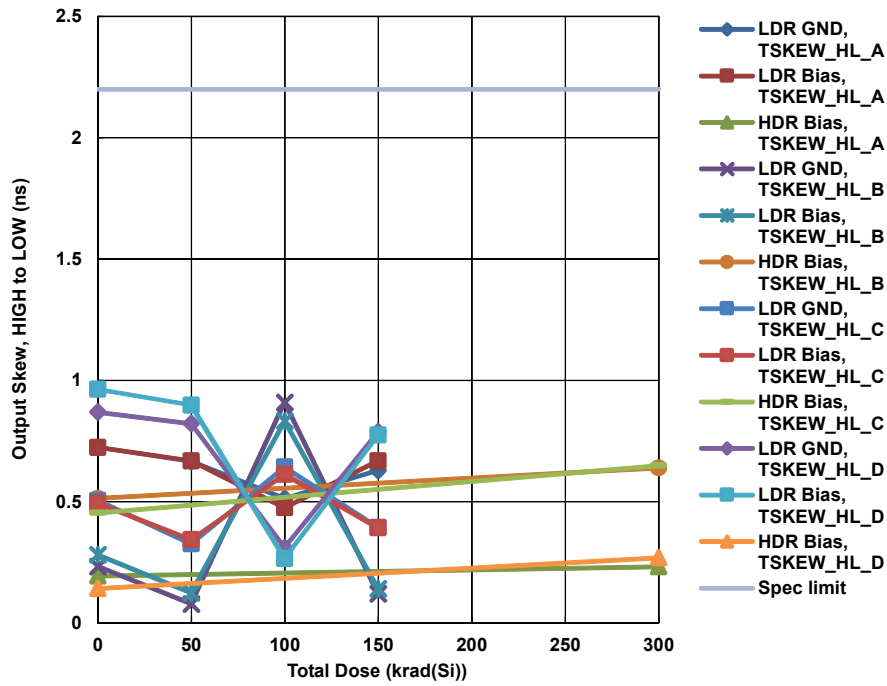

Figure 17. HS-26C31EH HIGH to LOW output skew, channels A through D, as a function of biased HDR total dose irradiation to 300krad(Si) and biased and unbiased (grounded) LDR irradiation to 150krad(Si). The sample size for the HDR cell was 48, while the sample sizes for the LDR cells were 20 each. SMD limit is 3ns maximum; the internal ATE limit (shown) is 2.2ns maximum.

### 3. Discussion and Conclusion

This report describes the results of total dose testing of the HS-26C31EH quad differential line driver. Parts were tested at LDR under biased and unbiased conditions and at HDR under biased conditions as part of routine production acceptance testing, to a total dose of 150krad(Si) (LDR) and 300krad(Si) (HDR). Testing at both dose rates showed zero rejected devices to either internal guardbanded ATE limits or the SMD pre-radiation limits, noting that the SMD pre-irradiation and post-radiation limits are the same for this part. The part is considered ELDRS-free, and no bias sensitivity was noted.

## 4. Appendices

### 4.1 Reported Parameters

Figure	Parameter	Limit, Low (Note 7)	Limit, High (Note 7)	Units	Notes
<a href="#">3</a>	Standby Supply Current	-	450	μ	Inputs at VCC and ground
<a href="#">4</a>	Tristate Output Leakage	-4.5	4.5	μA	OUT outputs
<a href="#">5</a>	Output HIGH Voltage	2.7	-	V	OUT outputs
<a href="#">6</a>	Output LOW Voltage	-	450	mV	OUT outputs
<a href="#">7</a>	Differential Output Voltage	2.2	-	V	OUT outputs
<a href="#">8</a>	Differential Output Voltage Match	-	380	mV	
<a href="#">9</a>	Common Mode Output Voltage	-	2.8	V	OUT outputs
<a href="#">10</a>	Input HIGH and LOW Leakage	-0.95	0.95	μA	
<a href="#">11</a>	Power OFF Output Leakage	-95	95	μA	OUT outputs
<a href="#">12</a>	Input LOW Voltage	1.75	-	V	
<a href="#">13</a>	Input HIGH Voltage	-	3.75	V	
<a href="#">14</a>	LOW to HIGH Propagation Delay	2	19	ns	OUT outputs
<a href="#">15</a>	HIGH to LOW Propagation Delay	2	19	ns	OUT outputs
<a href="#">16</a>	LOW to HIGH Output Skew		2.2	ns	
<a href="#">17</a>	HIGH to LOW Output Skew		2.2	ns	

Note:

7. These limits are taken from Standard Microcircuit Drawing (SMD) 5962-96663, with additional guardbanding for some parameters.

## 5. Revision History

Rev.	Date	Description
0.00	Jan 8, 2018	Initial release

## Notice

1. Descriptions of circuits, software and other related information in this document are provided only to illustrate the operation of semiconductor products and application examples. You are fully responsible for the incorporation or any other use of the circuits, software, and information in the design of your product or system. Renesas Electronics disclaims any and all liability for any losses and damages incurred by you or third parties arising from the use of these circuits, software, or information.
2. Renesas Electronics hereby expressly disclaims any warranties against and liability for infringement or any other claims involving patents, copyrights, or other intellectual property rights of third parties, by or arising from the use of Renesas Electronics products or technical information described in this document, including but not limited to, the product data, drawings, charts, programs, algorithms, and application examples.
3. No license, express, implied or otherwise, is granted hereby under any patents, copyrights or other intellectual property rights of Renesas Electronics or others.
4. You shall not alter, modify, copy, or reverse engineer any Renesas Electronics product, whether in whole or in part. Renesas Electronics disclaims any and all liability for any losses or damages incurred by you or third parties arising from such alteration, modification, copying or reverse engineering.
5. Renesas Electronics products are classified according to the following two quality grades: "Standard" and "High Quality". The intended applications for each Renesas Electronics product depends on the product's quality grade, as indicated below.  
"Standard": Computers; office equipment; communications equipment; test and measurement equipment; audio and visual equipment; home electronic appliances; machine tools; personal electronic equipment; industrial robots; etc.  
"High Quality": Transportation equipment (automobiles, trains, ships, etc.); traffic control (traffic lights); large-scale communication equipment; key financial terminal systems; safety control equipment; etc.  
Unless expressly designated as a high reliability product or a product for harsh environments in a Renesas Electronics data sheet or other Renesas Electronics document, Renesas Electronics products are not intended or authorized for use in products or systems that may pose a direct threat to human life or bodily injury (artificial life support devices or systems; surgical implantations; etc.), or may cause serious property damage (space system; undersea repeaters; nuclear power control systems; aircraft control systems; key plant systems; military equipment; etc.). Renesas Electronics disclaims any and all liability for any damages or losses incurred by you or any third parties arising from the use of any Renesas Electronics product that is inconsistent with any Renesas Electronics data sheet, user's manual or other Renesas Electronics document.
6. When using Renesas Electronics products, refer to the latest product information (data sheets, user's manuals, application notes, "General Notes for Handling and Using Semiconductor Devices" in the reliability handbook, etc.), and ensure that usage conditions are within the ranges specified by Renesas Electronics with respect to maximum ratings, operating power supply voltage range, heat dissipation characteristics, installation, etc. Renesas Electronics disclaims any and all liability for any malfunctions, failure or accident arising out of the use of Renesas Electronics products outside of such specified ranges.
7. Although Renesas Electronics endeavors to improve the quality and reliability of Renesas Electronics products, semiconductor products have specific characteristics, such as the occurrence of failure at a certain rate and malfunctions under certain use conditions. Unless designated as a high reliability product or a product for harsh environments in a Renesas Electronics data sheet or other Renesas Electronics document, Renesas Electronics products are not subject to radiation resistance design. You are responsible for implementing safety measures to guard against the possibility of bodily injury, injury or damage caused by fire, and/or danger to the public in the event of a failure or malfunction of Renesas Electronics products, such as safety design for hardware and software, including but not limited to redundancy, fire control and malfunction prevention, appropriate treatment for aging degradation or any other appropriate measures. Because the evaluation of microcomputer software alone is very difficult and impractical, you are responsible for evaluating the safety of the final products or systems manufactured by you.
8. Please contact a Renesas Electronics sales office for details as to environmental matters such as the environmental compatibility of each Renesas Electronics product. You are responsible for carefully and sufficiently investigating applicable laws and regulations that regulate the inclusion or use of controlled substances, including without limitation, the EU RoHS Directive, and using Renesas Electronics products in compliance with all these applicable laws and regulations. Renesas Electronics disclaims any and all liability for damages or losses occurring as a result of your noncompliance with applicable laws and regulations.
9. Renesas Electronics products and technologies shall not be used for or incorporated into any products or systems whose manufacture, use, or sale is prohibited under any applicable domestic or foreign laws or regulations. You shall comply with any applicable export control laws and regulations promulgated and administered by the governments of any countries asserting jurisdiction over the parties or transactions.
10. It is the responsibility of the buyer or distributor of Renesas Electronics products, or any other party who distributes, disposes of, or otherwise sells or transfers the product to a third party, to notify such third party in advance of the contents and conditions set forth in this document.
11. This document shall not be reprinted, reproduced or duplicated in any form, in whole or in part, without prior written consent of Renesas Electronics.
12. Please contact a Renesas Electronics sales office if you have any questions regarding the information contained in this document or Renesas Electronics products.  
(Note 1) "Renesas Electronics" as used in this document means Renesas Electronics Corporation and also includes its directly or indirectly controlled subsidiaries.  
(Note 2) "Renesas Electronics product(s)" means any product developed or manufactured by or for Renesas Electronics.

(Rev.4.0-1 November 2017)



### SALES OFFICES

Renesas Electronics Corporation

<http://www.renesas.com>

Refer to "<http://www.renesas.com/>" for the latest and detailed information.

**Renesas Electronics America Inc.**  
1001 Murphy Ranch Road, Milpitas, CA 95035, U.S.A.  
Tel: +1-408-432-8888, Fax: +1-408-434-5351

**Renesas Electronics Canada Limited**  
9251 Yonge Street, Suite 8309 Richmond Hill, Ontario Canada L4C 9T3  
Tel: +1-905-237-2004

**Renesas Electronics Europe Limited**  
Dukes Meadow, Millboard Road, Bourne End, Buckinghamshire, SL8 5FH, U.K  
Tel: +44-1628-651-700, Fax: +44-1628-651-804

**Renesas Electronics Europe GmbH**  
Arcadiastrasse 10, 40472 Düsseldorf, Germany  
Tel: +49-211-6503-0, Fax: +49-211-6503-1327

**Renesas Electronics (China) Co., Ltd.**  
Room 1709 Quantum Plaza, No.27 ZhichunLu, Haidian District, Beijing, 100191 P. R. China  
Tel: +86-10-8235-1155, Fax: +86-10-8235-7679

**Renesas Electronics (Shanghai) Co., Ltd.**  
Unit 301, Tower A, Central Towers, 555 Langao Road, Putuo District, Shanghai, 200333 P. R. China  
Tel: +86-21-2226-0888, Fax: +86-21-2226-0999

**Renesas Electronics Hong Kong Limited**  
Unit 1601-1611, 16/F., Tower 2, Grand Century Place, 193 Prince Edward Road West, Mongkok, Kowloon, Hong Kong  
Tel: +852-2265-6688, Fax: +852-2886-9022

**Renesas Electronics Taiwan Co., Ltd.**  
13F, No. 363, Fu Shing North Road, Taipei 10543, Taiwan  
Tel: +886-2-8175-9600, Fax: +886-2-8175-9670

**Renesas Electronics Singapore Pte. Ltd.**  
80 Bendemeer Road, Unit #06-02 Hyflux Innovation Centre, Singapore 339949  
Tel: +65-6213-0200, Fax: +65-6213-0300

**Renesas Electronics Malaysia Sdn.Bhd.**  
Unit 1207, Block B, Menara Amcorp, Amcorp Trade Centre, No. 18, Jln Persiaran Barat, 46050 Petaling Jaya, Selangor Darul Ehsan, Malaysia  
Tel: +60-3-7955-9390, Fax: +60-3-7955-9510

**Renesas Electronics India Pvt. Ltd.**  
No.777C, 100 Feet Road, HAL 2nd Stage, Indiranagar, Bangalore 560 038, India  
Tel: +91-80-67208700, Fax: +91-80-67208777

**Renesas Electronics Korea Co., Ltd.**  
17F, KAMCO Yangjae Tower, 262, Gangnam-daero, Gangnam-gu, Seoul, 06265 Korea  
Tel: +82-2-558-3737, Fax: +82-2-558-5338