

## HS-1840AxH

Neutron Testing of the HS-1840AxH Radiation Hardened 16-Channel Multiplexer

This report summarizes the results of 1MeV-equivalent neutron testing of the HS-1840AxH radiation hardened 16-channel multiplexers. The test was conducted to determine the sensitivity of the part to displacement damage (DD) caused by neutron or proton environments. Neutron fluences ranged from  $5 \times 10^{11} \text{ n/cm}^2$  to  $1 \times 10^{13} \text{ n/cm}^2$ .

### Product Description

The [HS-1840ARH](#) and [HS-1840AEH](#) are radiation hardened, monolithic 16-channel multiplexers constructed with the Renesas Rad-Hard Silicon Gate, bonded wafer, Dielectric Isolation process. The HS-1840ARH and HS-1840AEH provide a high input impedance to the analog source if device power fails (open), or the analog signal voltage inadvertently exceeds the supply by up to  $\pm 35\text{V}$ , regardless of whether the device is powered on or off. The HS-1840ARH and HS-1840AEH are excellent for use in redundant applications, because the secondary device can be operated in a standby unpowered mode requiring no additional power drain. More significantly, a high impedance exists between the active and inactive devices preventing any interaction.

One of the 16channel selections is controlled by a 4-bit binary address plus an Enable-Inhibit input, which conveniently controls the ON/OFF operation of several multiplexers in a system. All inputs have electrostatic discharge protection. The HS-1840ARH and HS-1840AEH are processed and screened in full compliance with MIL-PRF-38535 and QML standards. The devices are available in a 28 Ld SBDIP and a 28 Ld Ceramic Flatpack, which are shown in [Figure 1](#). **Note:** For testing purposes, the 28 Ld Flatpack was used.

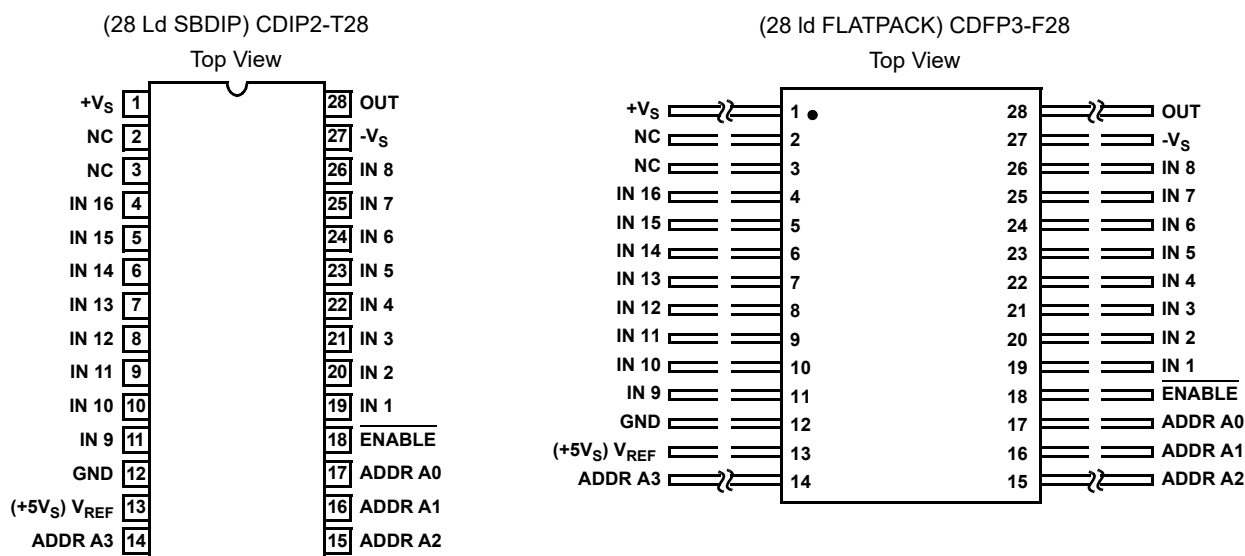

Figure 1. HS-1840AxH Package and Pinouts

## Contents

<b>1. Test Description</b> .....	<b>3</b>
1.1 Irradiation Facility .....	3
1.2 Test Fixturing .....	3
1.3 Radiation Dosimetry .....	3
1.4 Characterization Equipment and Procedures .....	3
1.5 Experimental Matrix .....	3
<b>2. Results</b> .....	<b>4</b>
2.1 Attributes Data .....	4
2.2 Variables Data .....	4
<b>3. Discussion and Conclusion</b> .....	<b>11</b>
<b>4. Revision History</b> .....	<b>11</b>
<b>Appendix</b> .....	<b>12</b>

# 1. Test Description

## 1.1 Irradiation Facility

Neutron fluence irradiations were performed on the test samples on August 31, 2021, at the University of Massachusetts, Lowell (UMASS Lowell) fast neutron irradiator per Mil-STD-883G, Method 1017.2, with each part unpowered during irradiation. The target irradiation levels were  $5 \times 10^{11} \text{n/cm}^2$ ,  $2 \times 10^{12} \text{n/cm}^2$ , and  $1 \times 10^{13} \text{n/cm}^2$ . As neutron irradiation activates many of the heavier elements found in a packaged integrated circuit, the parts exposed at the higher neutron levels required (as expected) some cooldown time before being shipped back to Renesas (Palm Bay, FL) for electrical testing.

## 1.2 Test Fixturing

No formal irradiation test fixturing is involved, as these DD tests are bag tests in that the parts are irradiated with all leads unbiased.

## 1.3 Radiation Dosimetry

Table 1 shows dosimetry from UMASS Lowell indicating the total accumulated gamma dose and actual neutron fluence exposure levels for each set of samples.

Table 1. HS-1840AxH Neutron Fluence Dosimetry Data

Irradiation	Requested Fluence (n/cm <sup>2</sup> )	Reactor Power (kW)	Time (s)	Fluence Rate (n/cm <sup>2</sup> -s) <sup>[1][2]</sup>	Gamma Dose (rad(Si)) <sup>[3]</sup>	Measured Fluence (n/cm <sup>2</sup> ) <sup>[4]</sup>
CRF#62106-A	5.00E+11	10	617	8.10E+08	70	5.38E+11
CRF#62106-B	2.00E+12	100	247	8.10E+09	281	2.05E+12
CRF#62106-C	1.00E+13	1000	123	8.10E+10	1401	1.14E+13

1. Dosimetry method: ASTM E-265.
2. The neutron fluence rate is determined from *Initial Testing of the New Ex-Core Fast Neutron Irradiator at UMass Lowell (6/18/02)*. Validated on 6/07/2011 under the Trident II D5LE neutron facility study by Navy Crane.
3. Based on reactor power at 1,000kW, the gamma dose is  $41 \pm 5.3\%$  krad(Si)/hr as mapped by TLD-based dosimetry.
4. Validated by S-32 flux monitors.

## 1.4 Characterization Equipment and Procedures

Electrical testing was performed before and after irradiation using the Renesas production automated test equipment (ATE). All electrical testing was performed at room temperature.

## 1.5 Experimental Matrix

Testing proceeded in general accordance with the guidelines of MIL-STD-883 TM 1017. The experimental matrix consisted of five samples to be irradiated at  $5 \times 10^{11} \text{n/cm}^2$ , five to be irradiated at  $2 \times 10^{12} \text{n/cm}^2$ , and five to be irradiated at  $1 \times 10^{13} \text{n/cm}^2$ . The actual levels achieved are shown in Table 2, which were  $5.38 \times 10^{11} \text{n/cm}^2$ ,  $2.05 \times 10^{12} \text{n/cm}^2$ , and  $1.14 \times 10^{13} \text{n/cm}^2$ . Three control units were used.

The 15 HS-1840AxH samples were drawn from Lot G4T0LEH. Samples were packaged in the standard hermetic 28 Lead Ceramic Flatpack (CDFP). Samples were processed through burn-in before irradiation and were screened to the SMD limits at room, low, and high temperatures before the start of neutron testing.

## 2. Results

Neutron testing of the HS-1840AxH is complete and the results are provided in this report. It should be understood when interpreting the data that each neutron irradiation was performed on a different set of samples. This is *not* total dose testing, where the damage is cumulative.

### 2.1 Attributes Data

Table 2. HS-1840AxH Attributes Data

1MeV Fluence, (n/cm <sup>2</sup> )		Sample Size	Pass <sup>[1]</sup>	Fail	Notes
Planned	Actual				
5×10 <sup>11</sup>	5.38×10 <sup>11</sup>	5	5	0	All passed
2×10 <sup>12</sup>	2.05×10 <sup>12</sup>	5	5	0	All passed
1×10 <sup>13</sup>	1.14×10 <sup>13</sup>	5	5	0	All passed

1. A pass indicates a sample that passes all SMD limits.

### 2.2 Variables Data

The plots in Figure 2 through Figure 15 show data plots for key parameters before and after irradiation to each level. The plots show the mean of each parameter as a function of neutron irradiation. For the switch measurements, the ATE program recorded the measurements for each of the 16 switches (such as leakage current), however, it was chosen to plot the average of the measurements. Therefore, if the graph and captions state that it is the average, the average of the 16 channels is plotted. The plots also include error bars at each data point, representing the minimum and maximum measured values of the samples, although in some plots the error bars might not be visible because of their values compared to the scale of the graph. While the applicable electrical limits taken from the SMD are also shown, it should be noted that these limits are provided for guidance only as the HS-1840AxH is not specified for the neutron environment. All samples passed the post-irradiation SMD limits after all were exposed up to and including 1.14×10<sup>13</sup>n/cm<sup>2</sup>.

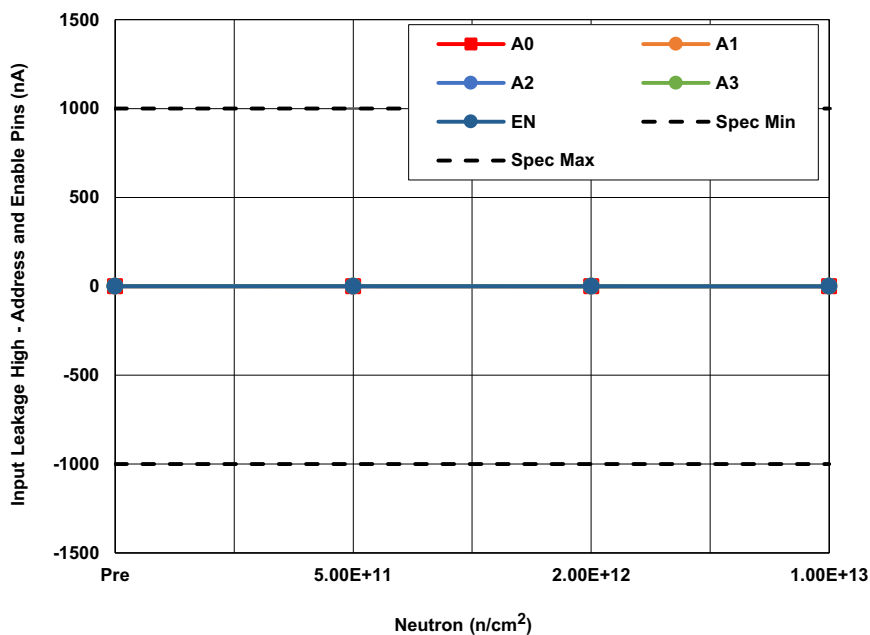

Figure 2. HS-1840AxH input leakage current high, address or enable pins ( $I_{AH}$ ) at  $V_+ = +15V$ ,  $V_- = -15V$ , following irradiation to each level. The error bars (if visible) represent the minimum and maximum measured values. The SMD limits are -1000nA minimum and 1000nA maximum.

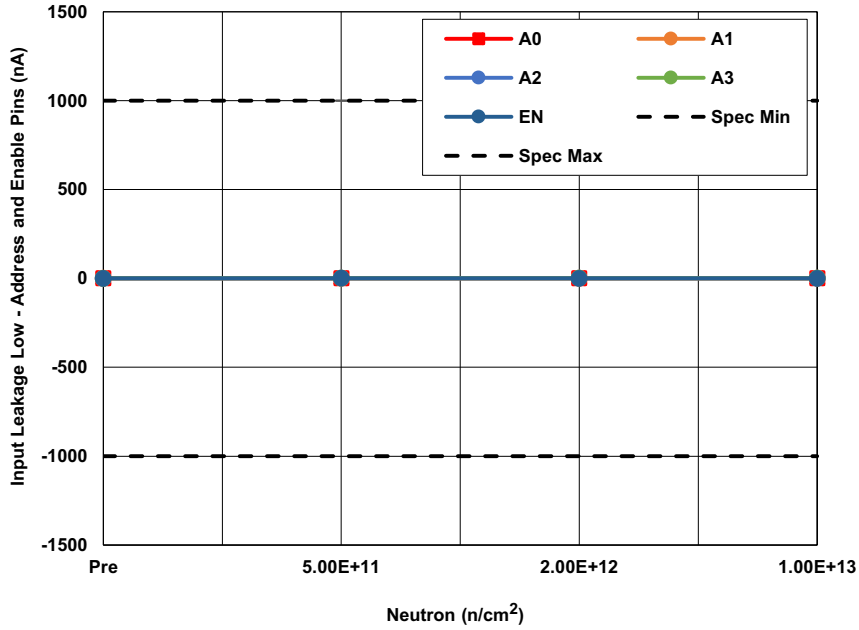

Figure 3. HS-1840AxH input leakage current low, address or enable pins ( $I_{AL}$ ) at  $V_+ = +15V$ ,  $V_- = -15V$ , following irradiation to each level. The error bars (if visible) represent the minimum and maximum measured values. The SMD limits are  $-1000nA$  minimum and  $1000nA$  maximum.

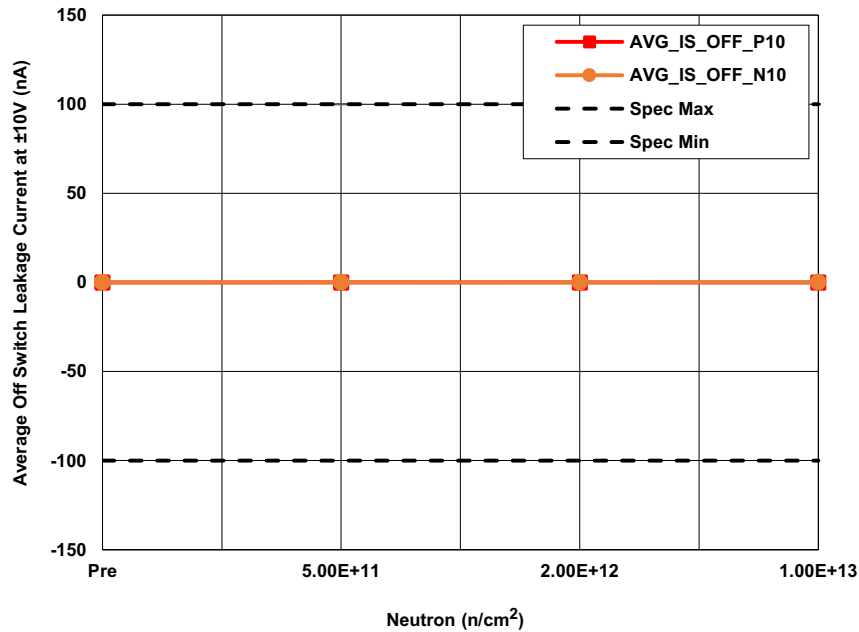

Figure 4. HS-1840AxH average leakage current into the source terminal of an off switch ( $I_{S(OFF)}$ ) following irradiation to each level. The error bars (if visible) represent the minimum and maximum measured values. The SMD limits are  $-100nA$  minimum and  $100nA$  maximum.

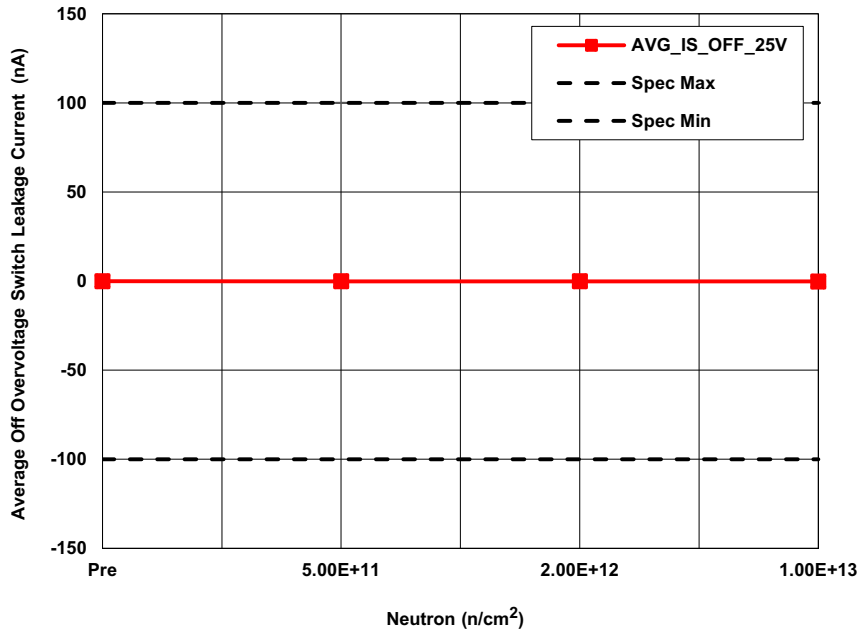

Figure 5. HS-1840AxH average leakage current into the source terminal of an off switch with power off ( $I_{S(OFF)power\ off}$ ) following irradiation to each level. The error bars (if visible) represent the minimum and maximum measured values. The SMD limits are -100nA minimum and 100nA maximum.

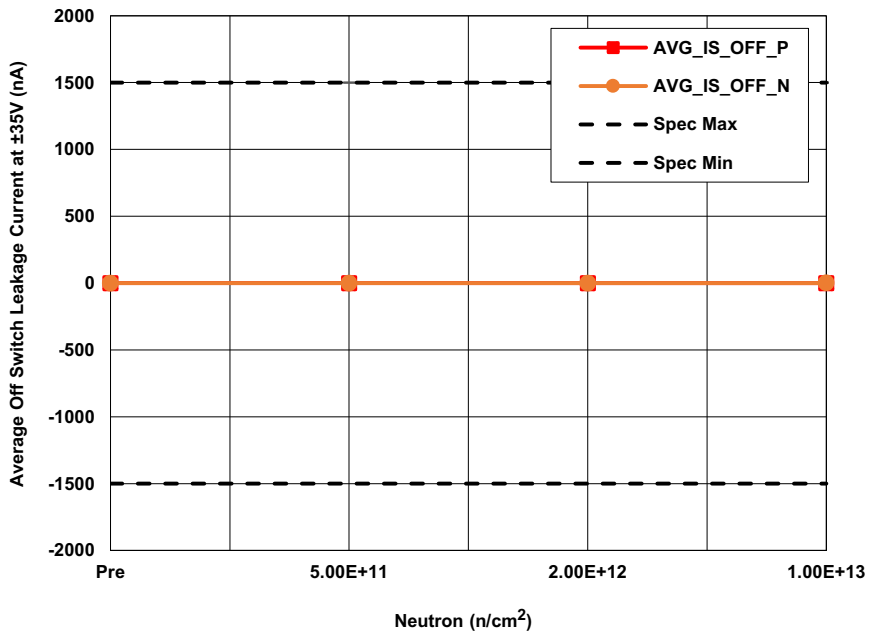

Figure 6. HS-1840AxH average leakage current into the source terminal of an off switch with overvoltage applied ( $I_{S(OFF)overvoltage}$ ) following irradiation to each level. The error bars (if visible) represent the minimum and maximum measured values. The SMD limits are -1500nA minimum and 1500nA maximum.

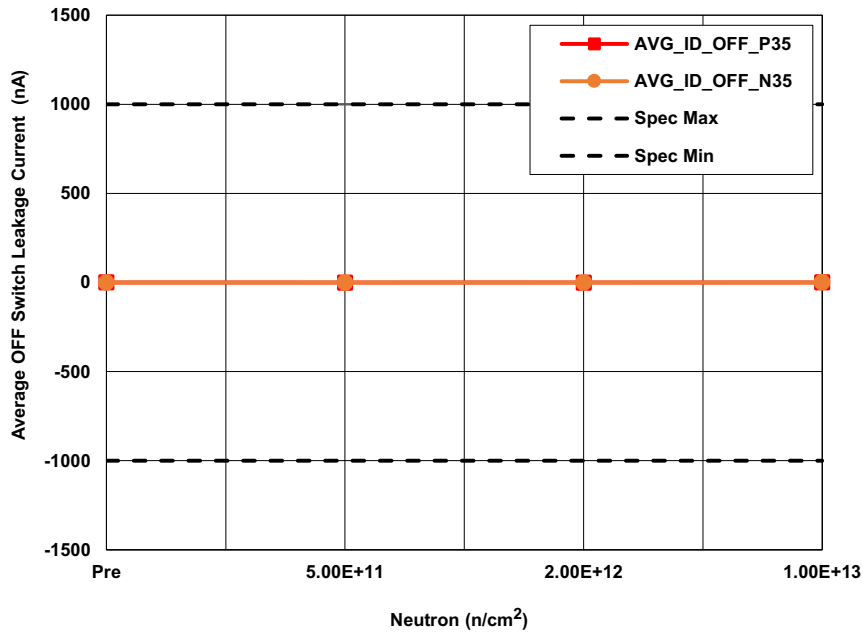

Figure 7. HS-1840AxH average leakage current into the drain terminal of an off switch with overvoltage applied following ( $I_{D(OFF)overvoltage}$ ) irradiation to each level. The error bars (if visible) represent the minimum and maximum measured values. The SMD limits are -1000nA minimum and 1000nA maximum.

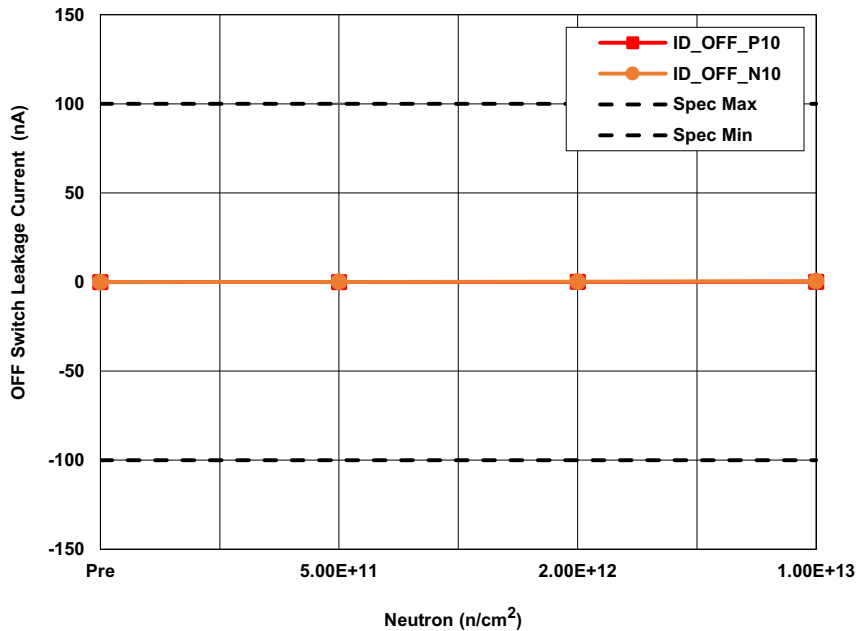

Figure 8. HS-1840AxH leakage current into the drain terminal of an off switch following ( $I_{D(OFF)}$ ) following irradiation to each level. The error bars (if visible) represent the minimum and maximum measured values. The SMD limits are -100nA minimum and 100nA maximum.

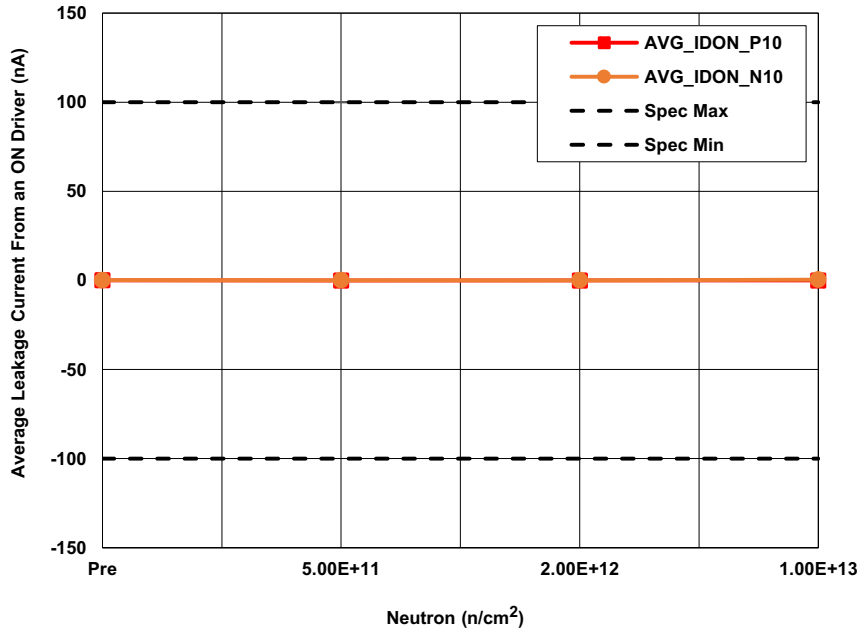

Figure 9. HS-1840AxH average leakage current from an on driver into the switch (drain and source) ( $I_{D(ON)}$ ) following irradiation to each level. The error bars (if visible) represent the minimum and maximum measured values. The SMD limits are -100nA minimum and 100nA maximum.

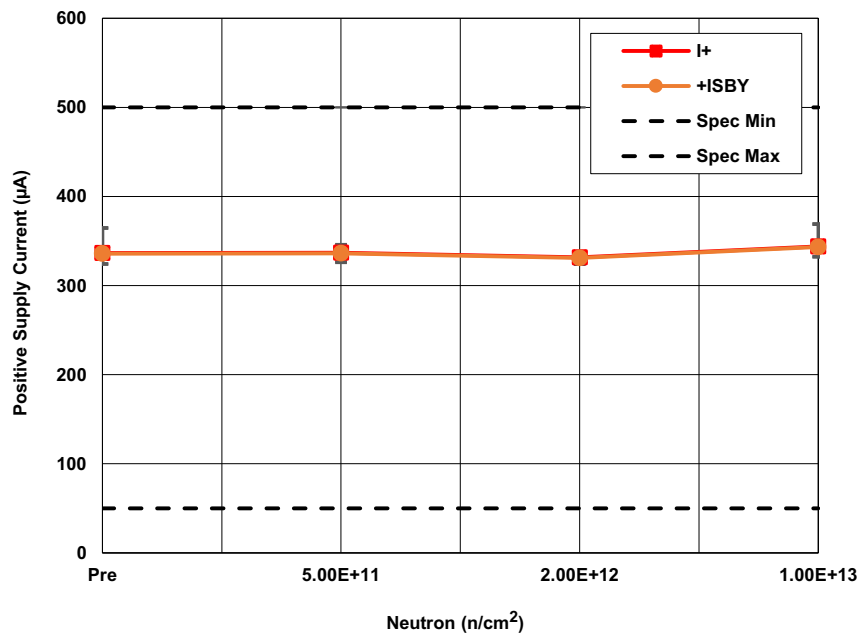

Figure 10. HS-1840AxH positive supply current ( $I_+$ ) and positive standby supply current ( $+I_{SBY}$ ) following irradiation to each level. The error bars (if visible) represent the minimum and maximum measured values. The SMD limits are 50µA minimum and 500µA maximum.



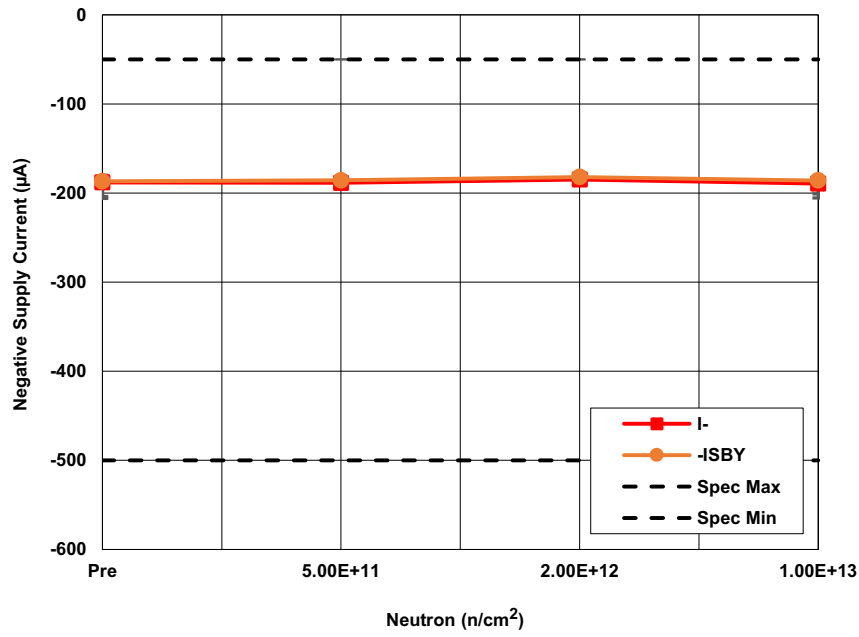

Figure 11. HS-1840AxH negative supply current (I-) and negative standby supply current (-I<sub>SBY</sub>) following irradiation to each level. The error bars (if visible) represent the minimum and maximum measured values. The SMD limits are -500µA minimum and -50µA maximum.

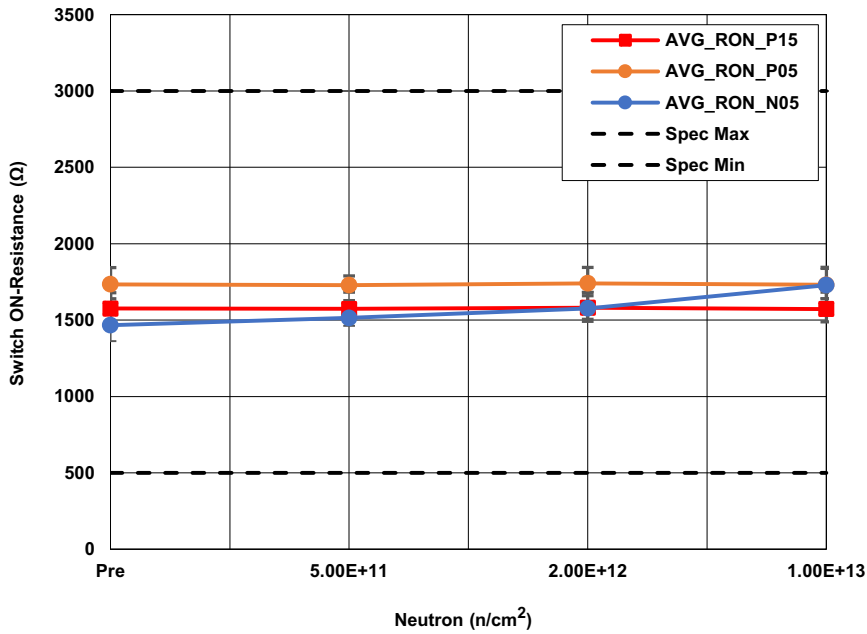

Figure 12. HS-1840AxH switch on-resistance (r<sub>DS(ON)</sub>) following irradiation to each level. The error bars (if visible) represent the minimum and maximum measured values. The SMD limits are 500Ω minimum and 3000Ω maximum.

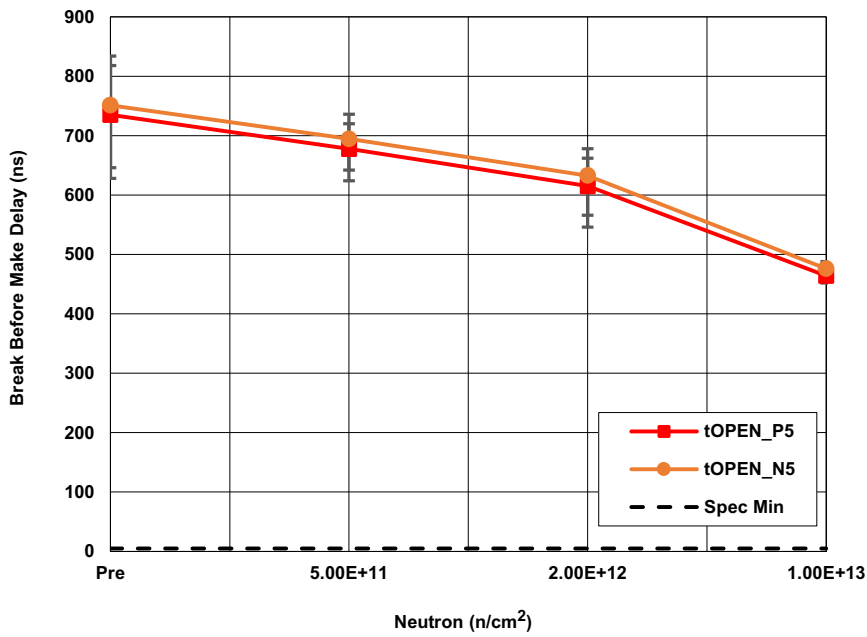

Figure 13. HS-1840AxH break-before-make time delay ( $t_D$ ) following irradiation to each level. The error bars (if visible) represent the minimum and maximum measured values. The SMD limit is 5ns minimum.

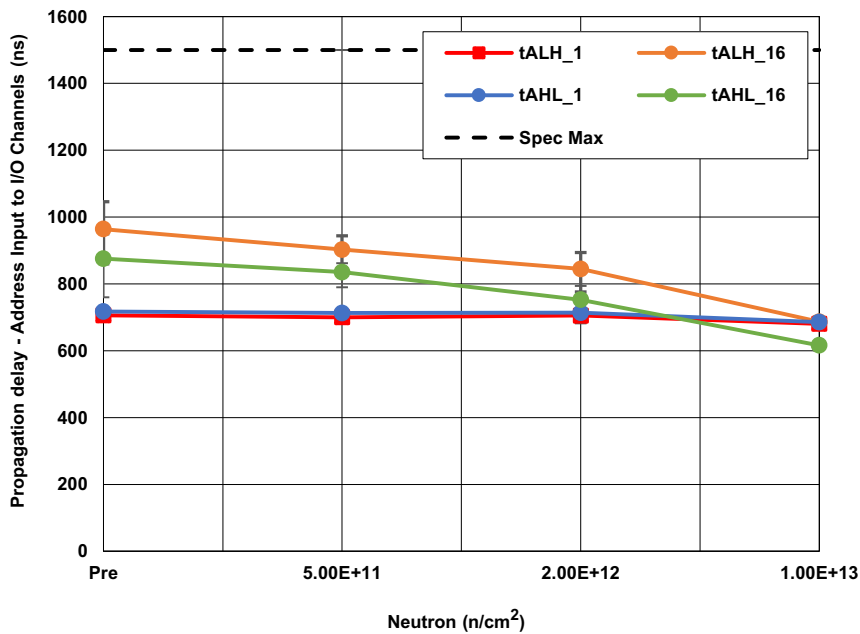

Figure 14. HS-1840AxH propagation delay time, address input to I/O channels ( $t_{on(A)}$ ,  $t_{off(A)}$ ) following irradiation to each level. The error bars (if visible) represent the minimum and maximum measured values. The SMD limit is 1500ns maximum.

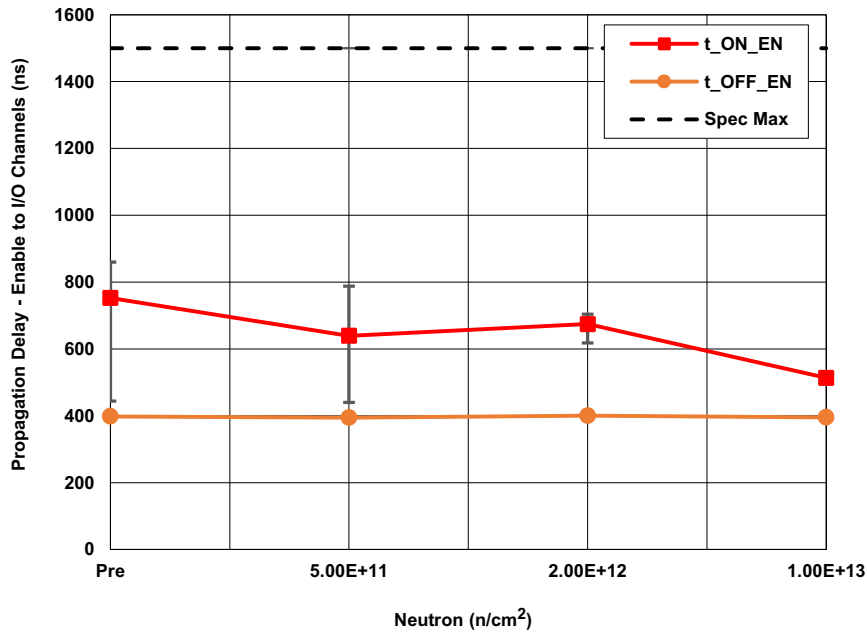

Figure 15. HS-1840AxH propagation delay time, enable to I/O channels (t<sub>on(EN)</sub>, t<sub>off(EN)</sub>) following irradiation to each level. The error bars (if visible) represent the minimum and maximum measured values. The SMD limit is 1500ns maximum.

### 3. Discussion and Conclusion

This document reports the results of 1MeV-equivalent neutron testing of the HS-1840AxH radiation-hardened 16-channel multiplexer. Parts were tested at actual fluences of 5.4×10<sup>11</sup>n/cm<sup>2</sup>, 2.1×10<sup>12</sup>n/cm<sup>2</sup>, and 1.1×10<sup>13</sup>n/cm<sup>2</sup>. The results of key parameters before and after irradiation to each level are plotted in Figure 2 through Figure 15. The plots show the mean of each parameter as a function of neutron irradiation, with error bars that represent the minimum and maximum measured values. The figures also show the applicable electrical limits taken from the SMD, but it should be noted that these limits are provided for guidance only as the HS-1840AxH is not specified for the neutron environment.

All samples passed the post-irradiation SMD limits after all were exposed up to and including 1.1×10<sup>13</sup>n/cm<sup>2</sup>.

### 4. Revision History

Revision	Date	Description
1.00	Mar 23, 2022	Initial release.

## Appendix

Table 3. Reported Parameters

Fig.	Parameter	Symbol	Test Conditions	Low Limit	High Limit	Units
2	Input Leakage Current High address or enable pins	$I_{AH}$	$V_{AH} = 4V, V_{AL} = 0.8V, V_{EN} = 4V$ and $V_{REF} = 5V$ , all unused inputs = 0V	-1000	1000	nA
3	Input Leakage Current Low address or enable pins	$I_{AL}$				
4	Leakage current into the source terminal of an off switch	$I_{S(OFF)}$	$V_S = \pm 10V$	-100	100	nA
5	Leakage current into the source terminal of an off switch with power off	$I_{S(OFF)power\ off}$	$V_S = +25V, V_A = 0V, V_{EN} = 0V, V_- = 0V, V_+ = 0V$ and $V_{REF} = 0V$ , all unused inputs = 0V	-100	100	nA
6	Leakage current into the source terminal of an off switch with overvoltage applied	$I_{S(OFF)overvoltage}$	$V_D = 0V$ , all unused inputs = 0V	-1500	1500	nA
7	Leakage current into the drain terminal of an off switch with overvoltage applied	$I_{D(OFF)overvoltage}$	$V_D = 0V$ , all unused inputs = 0V	-1000	1000	nA
8	Leakage current into the drain terminal of an off switch	$I_{D(OFF)}$	$V_D = \pm 10V$ , all unused inputs = +10V or -10V	-100	100	nA
9	Leakage current from an on driver into the switch (drain and source)	$I_{D(ON)}$	$V_S = +10V, V_D = +10V, V_{EN} = 0.8V$ , all unused inputs = -10V	-100	100	nA
10	Positive Supply Current	$I_+$	$V_A = 0V, V_{EN} = 0.8V$	50	500	$\mu A$
	Positive Standby Supply Current	$+I_{SBY}$	$V_A = 0V, V_{EN} = 4.0V$	50	500	$\mu A$
11	Negative Supply Current	$I_-$	$V_A = 0V, V_{EN} = 0.8V$	-500	-50	$\mu A$
	Negative Standby Supply Current	$-I_{SBY}$	$V_A = 0V, V_{EN} = 4.0V$	-500	-50	$\mu A$
12	Switch On-Resistance	$r_{DS(ON)}$	$V_S = V_+, V_{EN} = 0.8V, I_D = -1mA$	500	3000	$\Omega$
13	Break-Before-Make Time Delay	$t_D$	$C_L = 50pF, R_L = 1k\Omega$	5	-	ns
14	Propagation Delay Time Address Input to I/O Channels	$t_{on(A)}, t_{OFF(A)}$	$C_L = 50pF, R_L = 10k\Omega$	-	1500	ns
15	Propagation Delay Time Enable to I/O Channels	$t_{on(EN)}, t_{OFF(EN)}$	$C_L = 50pF, R_L = 1k\Omega$	-	1500	ns

## IMPORTANT NOTICE AND DISCLAIMER

RENESAS ELECTRONICS CORPORATION AND ITS SUBSIDIARIES (“RENESAS”) PROVIDES TECHNICAL SPECIFICATIONS AND RELIABILITY DATA (INCLUDING DATASHEETS), DESIGN RESOURCES (INCLUDING REFERENCE DESIGNS), APPLICATION OR OTHER DESIGN ADVICE, WEB TOOLS, SAFETY INFORMATION, AND OTHER RESOURCES “AS IS” AND WITH ALL FAULTS, AND DISCLAIMS ALL WARRANTIES, EXPRESS OR IMPLIED, INCLUDING, WITHOUT LIMITATION, ANY IMPLIED WARRANTIES OF MERCHANTABILITY, FITNESS FOR A PARTICULAR PURPOSE, OR NON-INFRINGEMENT OF THIRD PARTY INTELLECTUAL PROPERTY RIGHTS.

These resources are intended for developers skilled in the art designing with Renesas products. You are solely responsible for (1) selecting the appropriate products for your application, (2) designing, validating, and testing your application, and (3) ensuring your application meets applicable standards, and any other safety, security, or other requirements. These resources are subject to change without notice. Renesas grants you permission to use these resources only for development of an application that uses Renesas products. Other reproduction or use of these resources is strictly prohibited. No license is granted to any other Renesas intellectual property or to any third party intellectual property. Renesas disclaims responsibility for, and you will fully indemnify Renesas and its representatives against, any claims, damages, costs, losses, or liabilities arising out of your use of these resources. Renesas' products are provided only subject to Renesas' Terms and Conditions of Sale or other applicable terms agreed to in writing. No use of any Renesas resources expands or otherwise alters any applicable warranties or warranty disclaimers for these products.

(Rev.1.0 Mar 2020)

### Corporate Headquarters

TOYOSU FORESIA, 3-2-24 Toyosu,  
Koto-ku, Tokyo 135-0061, Japan  
[www.renesas.com](http://www.renesas.com)

### Contact Information

For further information on a product, technology, the most up-to-date version of a document, or your nearest sales office, please visit:  
[www.renesas.com/contact/](http://www.renesas.com/contact/)

### Trademarks

Renesas and the Renesas logo are trademarks of Renesas Electronics Corporation. All trademarks and registered trademarks are the property of their respective owners.