

144-PIN PLASTIC FBGA (12x12)

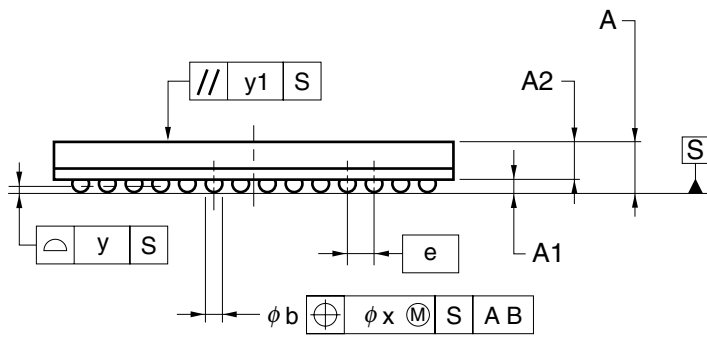
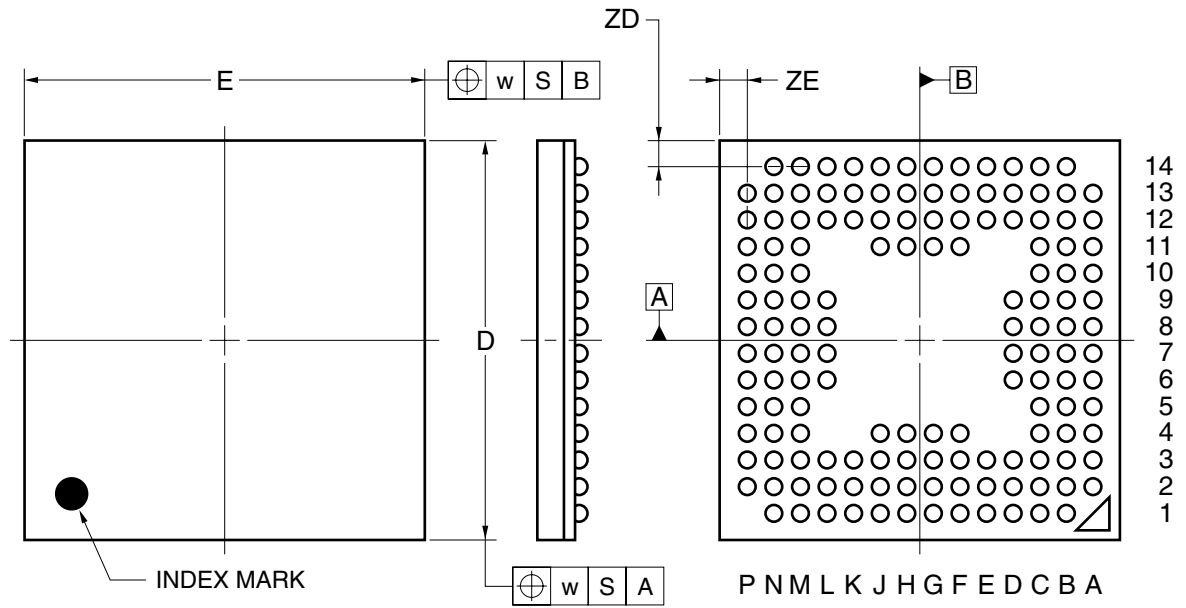

ITEM	MILLIMETERS
D	12.00±0.10
E	12.00±0.10
w	0.20
A	1.48±0.10
A1	0.35±0.06
A2	1.13
e	0.80
b	0.50 ^{+0.05} _{-0.10}
x	0.08
y	0.10
y1	0.20
ZD	0.80
ZE	0.80

P144F1-80-EA8