

SAWN OPTION (Q1) PAGE 1 OF 2

DATE CREATED		REVISIONS		AUTHOR
12/5/12	00	INITIAL RELEASE.		RC
10/15/13	01	ORGANIZE SAWN AND PUNCH DWG		J.HUA
11/21/13	02	ADD EPAD OPTION		J.HUA
12/12/13	03	ADD LAND PATTERN DESCRIPTION		J.HUA
3/6/14	04	UPDATE "L" DIM on PUNCH' TO MATCH		J.HUA
3/2/17	05	ADD EPAD OPTION		J.HUA
5/2/17	06	CHANGE QFN to VFQFPN		J.HUA
9/3/19	07	Update P1 Dim/ Punch to (D1 add S1)		J.HUA
7/30/21	08	Update Dimensions of Wetable Flank		JHTAN

NOTE: REFER TO DCP FOR OFFICIAL RELEASE DATE

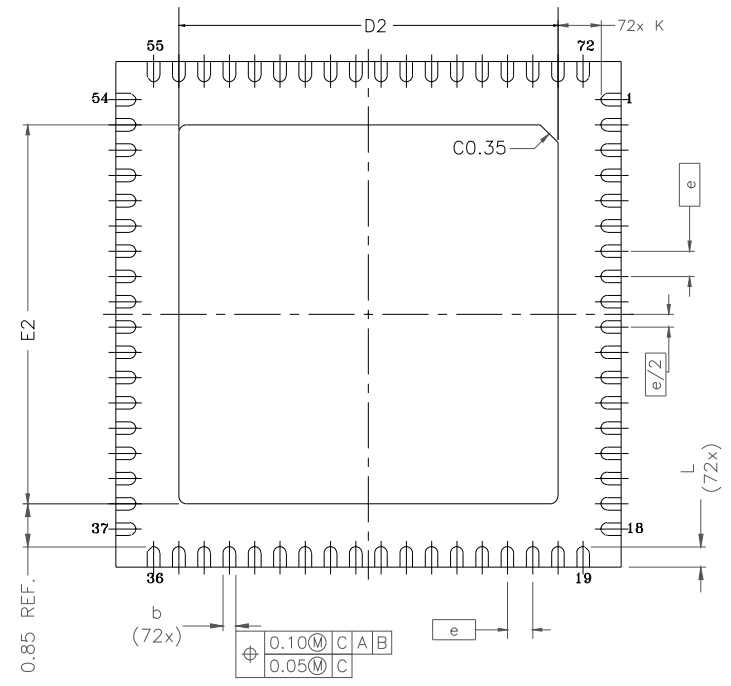
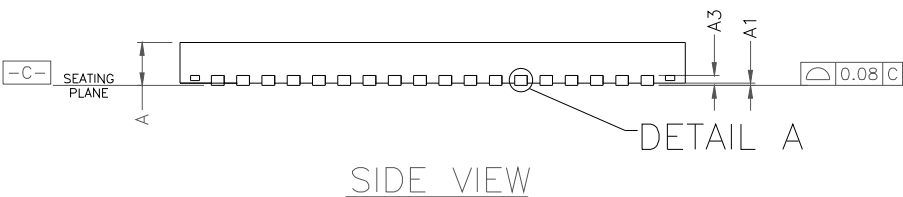
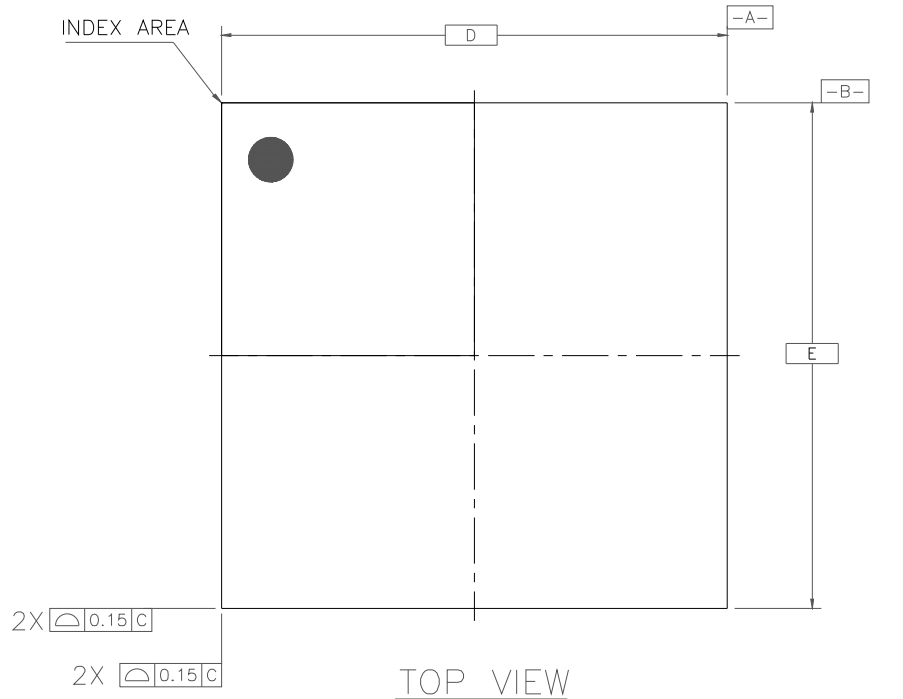

NOTES:

1. ALL DIMENSIONING AND TOLERANCING CONFORM TO ANSI Y14.5M-1994
2. ALL DIMENSIONS ARE IN MILLIMETERS.
3. INDEX AREA (PIN1 IDENTIFIER)

TOLERANCES UNLESS SPECIFIED		6024 Silver Creek Valley Road	
DECIMAL	ANGULAR	San Jose, CA 95138	
X±		PHONE: (408) 284-8200	
XX±		FAX: (408) 284-8591	
XXX±			
TITLE NL/NLG72 Package Outline Drawing			
10.0X10.0 mm Body			
0.50 mm Pitch VFQFPN			
SIZE	DRAWING No.	REV	
C	PSC-4208	08	
DO NOT SCALE DRAWING			SHEET 1 OF 6

SAWN OPTION (Q1) PAGE 2 OF 2

DATE CREATED	REVISIONS		
	REV	DESCRIPTION	AUTHOR
12/5/12	00	INITIAL RELEASE.	rc
10/15/13	01	ORGANIZE SAWN AND PUNCH DWG	J.HUA
11/21/13	02	ADD EPAD OPTION	J.HUA
12/12/13	03	ADD LAND PATTERN DESCRIPTION	J.HUA
3/6/14	04	UPDATE "L" DIM on PUNCH TO MATCH	J.HUA
3/2/17	05	ADD EPAD OPTION	J.HUA
5/2/17	06	CHANGE QFN to VFQFPN	J.HUA
9/3/19	07	Update P1 Dim/ Punch to (D1 add S1)	J.HUA
7/30/21	08	Update Dimensions of Wettable Flank	JHTAN

NOTE: REFER TO DCP FOR OFFICIAL RELEASE DATE

EPAD OPTION:

SYMBOL	DIMENSION			NOTE
	MIN.	NOM.	MAX.	
D2	SEE EPAD OPTION			
F2	SEE EPAD OPTION			
K	0.20	—	—	
A2	0.00	0.65	1.00	
L	0.30	0.40	0.50	
COMMON DIMENSIONS				
DIM SYMBOL	MIN	NOM	MAX	
A	0.80	0.90	1.00	
A1	0	0.02	0.05	
A3 REF	—	0.20 ref	—	
b	0.18	0.25	0.30	
Ⓢ	0.50 BSC			
D	10.00 BSC			
E	10.00 BSC			

SYMBOL	P1			P2			P3			P4		
	MIN.	NOM.	MAX.	MIN.	NOM.	MAX.	MIN.	NOM.	MAX.	MIN.	NOM.	MAX.
E2	5.80	5.95	6.10	7.40	7.50	7.60	8.30	8.40	8.50	7.60	7.70	7.80
D2	5.80	5.95	6.10	7.40	7.50	7.60	8.30	8.40	8.50	7.60	7.70	7.80

SYMBOL	S1		
	MIN.	NOM.	MAX.
E2	6.40	6.50	6.60
D2	6.40	6.50	6.60

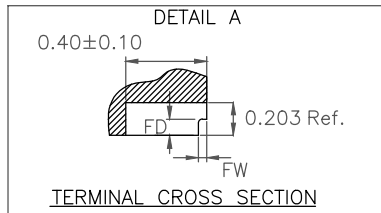

Table 1: Dimensions of wettable flank (DETAIL A)

Symbol	Unit (mm)	
	MIN	MAX
FD	0.100	—
FW	0.001	0.075

TOLERANCES UNLESS SPECIFIED		6024 Silver Creek Valley Road San Jose, CA 95138 PHONE: (408) 284-8200 FAX: (408) 284-8591
DECIMAL	ANGULAR	
X±		
XX±		
XXX±		
TITLE NL/NLG72 Package Outline Drawing 10.0X10.0 mm Body 0.50 mm Pitch VFQFPN		
SIZE	DRAWING No.	REV
C	PSC-4208	08
DO NOT SCALE DRAWING		SHEET 2 OF 6

PUNCH OPTION (Q2) PAGE 1 OF 3

REVISIONS			
DATE CREATED	REV	DESCRIPTION	AUTHOR
12/5/12	00	INITIAL RELEASE.	RC
10/15/13	01	ORGANIZE SAWN AND PUNCH DWG	J.HUA
11/21/13	02	ADD EPAD OPTION	J.HUA
12/12/13	03	ADD LAND PATTERN DESCRIPTION	J.HUA
3/6/14	04	UPDATE "L" DIM on PUNCH' TO MATCH	J.HUA
3/2/17	05	ADD EPAD OPTION	J.HUA
5/2/17	06	CHANGE QFN to VFQFPN	J.HUA
9/3/19	07	Update P1 Dim/ Punch to (D1 add S1)	J.HUA
7/30/21	08	Update Dimensions of Wettable Flank	JHTAN

NOTE: REFER TO DCP FOR OFFICIAL RELEASE DATE

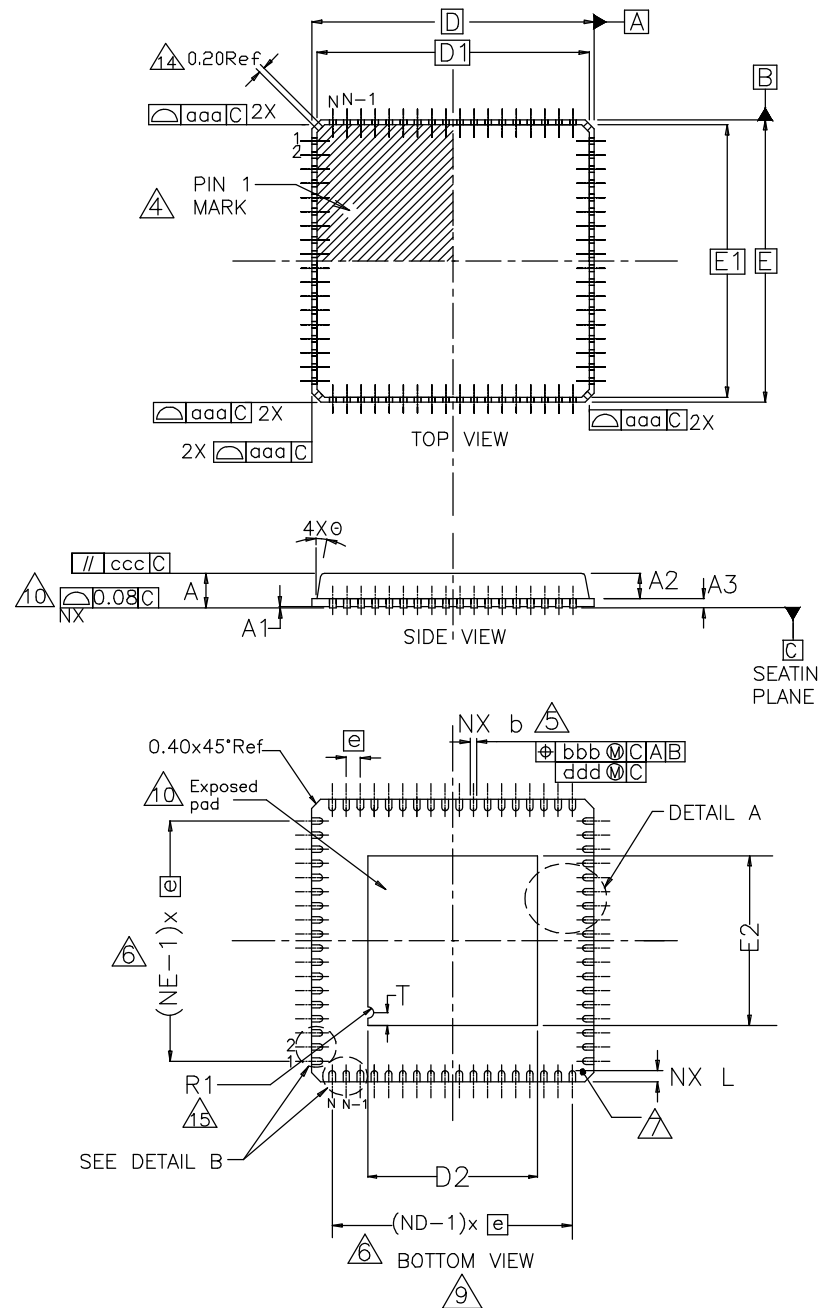

TOLERANCES UNLESS SPECIFIED DECIMAL ANGULAR X± XX± XXX±	6024 Silver Creek Valley Road San Jose, CA 95138 PHONE: (408) 284-8200 FAX: (408) 284-8591	
		
TITLE NL/NLG72 Package Outline Drawing 10.0X10.0 mm Body 0.50 mm Pitch VFQFPN		
SIZE C	DRAWING No. PSC-4208	REV 08
DO NOT SCALE DRAWING		SHEET 3 OF 6

PUNCH OPTION (Q2) PAGE 2 OF 3

DATE CREATED		REVISIONS		
		REV	DESCRIPTION	AUTHOR
12/5/12	00		INITIAL RELEASE.	RC
10/15/13	01		ORGANIZE SAWN AND PUNCH DWG	J.HUA
11/21/13	02		ADD EPAD OPTION	J.HUA
12/12/13	03		ADD LAND PATTERN DESCRIPTION	J.HUA
3/6/14	04		UPDATE "L" DIM on PUNCH' TO MATCH	J.HUA
3/2/17	05		ADD EPAD OPTION	J.HUA
5/2/17	06		CHANGE QFN to VFQFPN	J.HUA
9/3/19	07		Update P1 Dim/ Punch to (D1 add S1)	J.HUA
7/30/21	08		Update Dimensions of Wettable Flank	JHTAN

NOTE: REFER TO DCP FOR OFFICIAL RELEASE DATE

EPAD OPTION:

SYMBOL	DIMENSION			NOTE
	MIN.	NOM.	MAX.	
D2	SEE EPAD OPTION			
E2	SEE EPAD OPTION			
k	0.20	—	—	
N		72		3
Nd		18		6
Ne		18		6
A2	0.00	0.65	1.00	
L	0.30	0.40	0.50	

SYMBOL	D1		
	MIN.	NOM.	MAX.
E2	5.80	5.90	6.00
D2	5.80	5.90	6.00

COMMON DIMENSIONS

SYMBOL \ DIM	MIN	NOM	MAX
A	0.80	0.90	1.00
A1	0	0.02	0.05
D1	9.75 BSC		
E1	9.75 BSC		
A3 REF	—	0.20 ref	—
θ	0	—	14
T ref.	—	0.45	—
R1	—	0.20	—
R ref. b min/2			
NOTES		1,2	
b	0.18	0.25	0.30
⊙	0.50 BSC		
D	10.00 BSC		
E	10.00 BSC		

NOTES:

1. DIMENSIONING & TOLERANCING CONFORM TO ASME Y14.5M-1994.
2. ALL DIMENSIONS ARE IN MILLIMETERS. ANGLES ARE IN DEGREES.
3. N IS THE TOTAL NUMBER OF TERMINALS.
Nd IS THE NUMBER OF TERMINALS IN X-DIRECTION &
Ne IS THE NUMBER OF TERMINALS IN Y-DIRECTION.
4. THE TERMINAL #1 IDENTIFIER AND TERMINAL NUMBERING CONVENTION SHALL CONFORM TO JEDEC PUB. 95 SEC. 4.3 SPP-002. DETAILS OF TERMINAL #1 IDENTIFIER ARE OPTIONAL, BUT MUST BE LOCATED WITHIN THE ZONE INDICATED. THE TERMINAL #1 IDENTIFIER MAY BE EITHER A MOLD OR MARKED FEATURE.
5. DIMENSION b APPLIES TO METALLIZED TERMINAL AND IS MEASURED BETWEEN 0.25mm AND 0.30mm FROM TERMINAL TIP.
6. ND AND NE REFER TO THE NUMBER OF TERMINALS ON EACH D AND E SIDE RESPECTIVELY.
7. DEPOPULATION IS POSSIBLE IN A SYMMETRICAL FASHION.

TOLERANCE OF FORM & POSITION	
aaa	0.15
bbb	0.10
ccc	0.10
ddd	0.05
NOTES	1,2

TOLERANCES UNLESS SPECIFIED DECIMAL ANGULAR X± XX± XXX±	6024 Silver Creek Valley Road San Jose, CA 95138 PHONE: (408) 284-8200 FAX: (408) 284-8591
TITLE NL/NLG72 Package Outline Drawing 10.0X10.0 mm Body 0.50 mm Pitch VFQFPN	
SIZE	DRAWING No. REV
C	PSC-4208 08
DO NOT SCALE DRAWING	
SHEET 4 OF 6	

PUNCH OPTION (Q2) PAGE 3 OF 3

REVISIONS			
DATE CREATED	REV	DESCRIPTION	AUTHOR
12/5/12	00	INITIAL RELEASE.	RC
10/15/13	01	ORGANIZE SAWN AND PUNCH DWG	J.HUA
11/21/13	02	ADD EPAD OPTION	J.HUA
12/12/13	03	ADD LAND PATTERN DESCRIPTION	J.HUA
3/6/14	04	UPDATE "L" DIM on PUNCH' TO MATCH	J.HUA
3/2/17	05	ADD EPAD OPTION	J.HUA
5/2/17	06	CHANGE QFN to VQFPN	J.HUA
9/3/19	07	Update P1 Dim/ Punch to (D1 add S1)	J.HUA
7/30/21	08	Update Dimensions of Wettable Flank	JHTAN

NOTE: REFER TO DCP FOR OFFICIAL RELEASE DATE

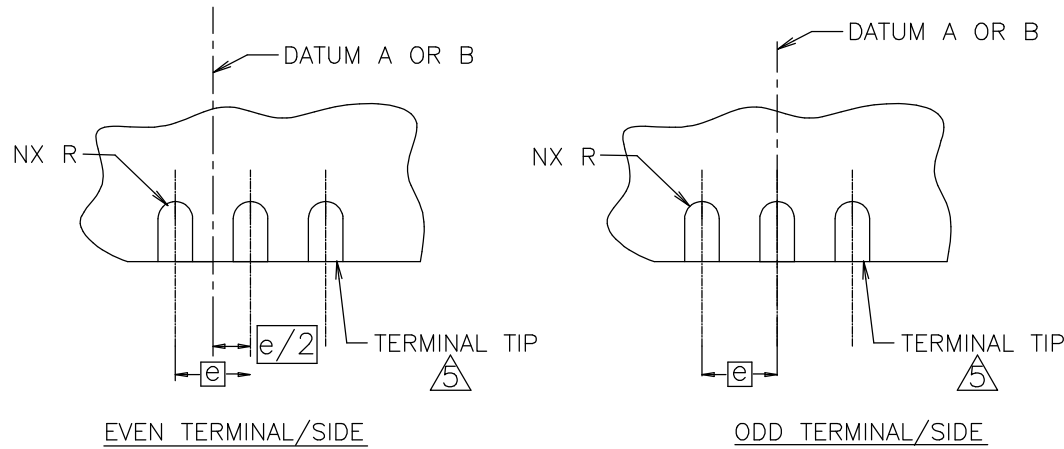

DETAIL B

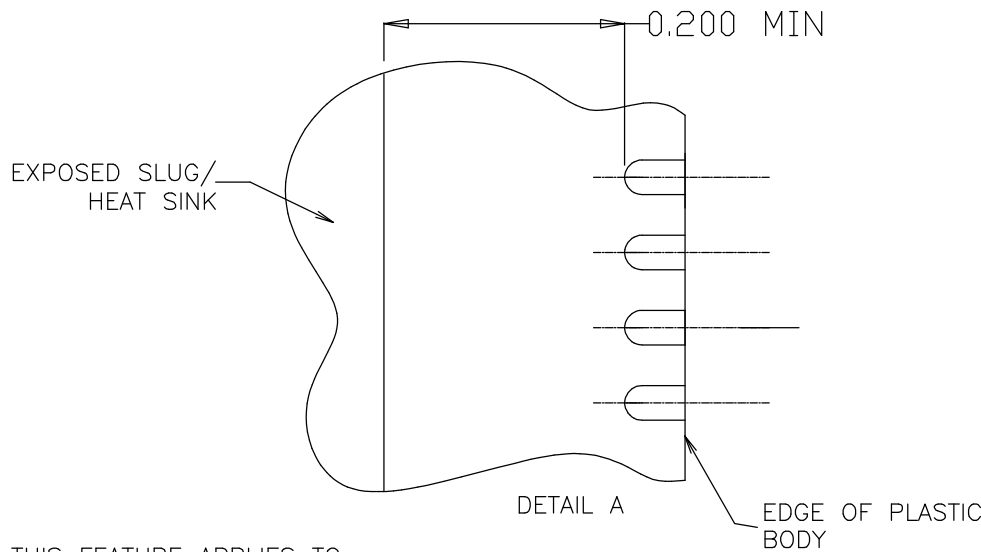

THIS FEATURE APPLIES TO ALL ENDS OF THE PKG.

TOLERANCES UNLESS SPECIFIED		6024 Silver Creek Valley Road San Jose, CA 95138	
DECIMAL	ANGULAR	RENESAS PHONE: (408) 284-8200	
X±		FAX: (408) 284-8591	
XX±		TITLE NL/NLG72 Package Outline Drawing	
XXX±		10.0X10.0 mm Body	
		0.50 mm Pitch VQFPN	
SIZE	DRAWING No.	REV	
C	PSC-4208	08	
DO NOT SCALE DRAWING			SHEET 5 OF 6

DATE CREATED	REVISIONS		
	REV	DESCRIPTION	AUTHOR
12/5/12	00	INITIAL RELEASE.	RC
10/15/13	01	ORGANIZE SAWN AND PUNCH DWG	J.HUA
11/21/13	02	ADD EPAD OPTION	J.HUA
12/12/13	03	ADD LAND PATTERN DESCRIPTION	J.HUA
3/6/14	04	UPDATE "L" DIM on 'PUNCH' TO MATCH	J.HUA
3/2/17	05	ADD EPAD OPTION	J.HUA
5/2/17	06	CHANGE QFN to VFQFPN	J.HUA
9/3/19	07	Update P1 Dim/ Punch to (D1 add S1)	J.HUA
7/30/21	08	Update Dimensions of Wetable Flank	JHTAN

NOTE: REFER TO DCP FOR OFFICIAL RELEASE DATE

SAWN LAND PATTERN

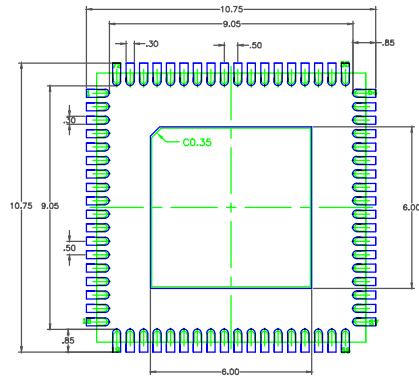

P1 EPAD 5.95 mm SQ

SAWN LAND PATTERN

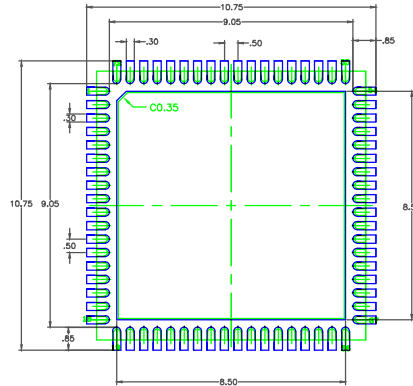

P3 EPAD 8.4 mm SQ

SAWN LAND PATTERN

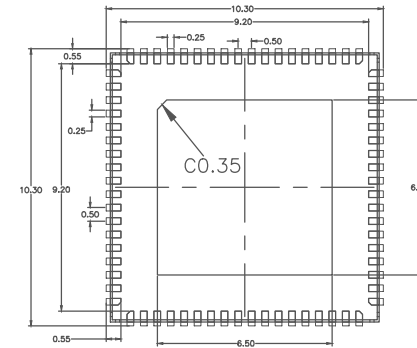

S1 EPAD 6.50 mm SQ

SAWN LAND PATTERN

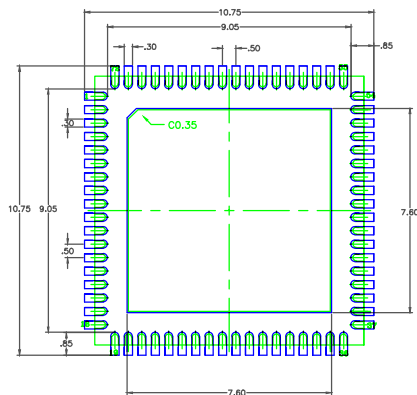

P2 EPAD 7.5 mm SQ

SAWN LAND PATTERN

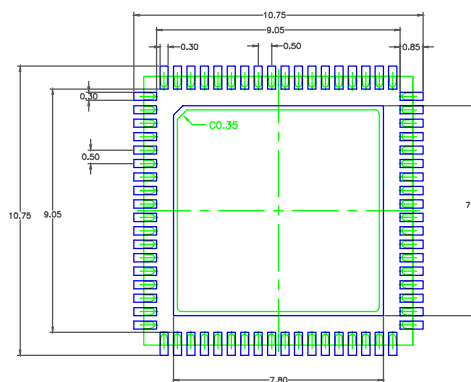

P4 EPAD 7.7 mm SQ

PUNCH LAND PATTERN

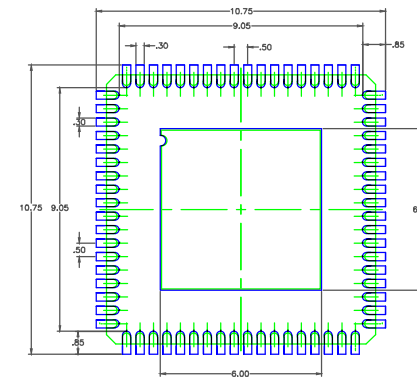

D1 EPAD 5.9 mm SQ

RECOMMENDED LAND PATTERN DIMENSION

NOTES:

1. ALL DIMENSION ARE IN mm. ANGLES IN DEGREES.
2. TOP DOWN VIEW. AS VIEWED ON PCB.
3. COMPONENT OUTLINE SHOW FOR REFERENCE IN GREEN.
4. LAND PATTERN IN BLUE. NSMD PATTERN ASSUMED.
5. LAND PATTERN RECOMMENDATION PER IPC-7351B GENERIC REQUIREMENT FOR SURFACE MOUNT DESIGN AND LAND PATTERN.

TOLERANCES UNLESS SPECIFIED DECIMAL ANGULAR XX± XXX± XXX±	6024 Silver Creek Valley Road San Jose, CA 95138 PHONE: (408) 284-8200 FAX: (408) 284-8591	
	RENESAS	
TITLE NL/NLG72 Package Outline Drawing 10.0X10.0 mm Body 0.50 mm Pitch VFQFPN		
SIZE C	DRAWING No. PSC-4208	REV 08
DO NOT SCALE DRAWING		SHEET 6 OF 6