

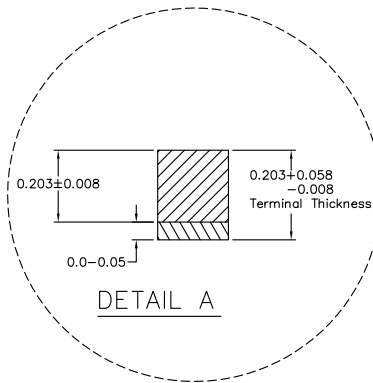

REVISIONS			
REV	DESCRIPTION	DATE	APPROVED
00	INITIAL RELEASE	01/11/16	JH

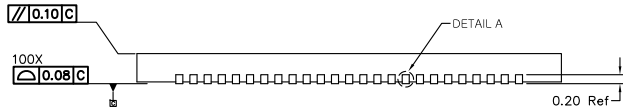
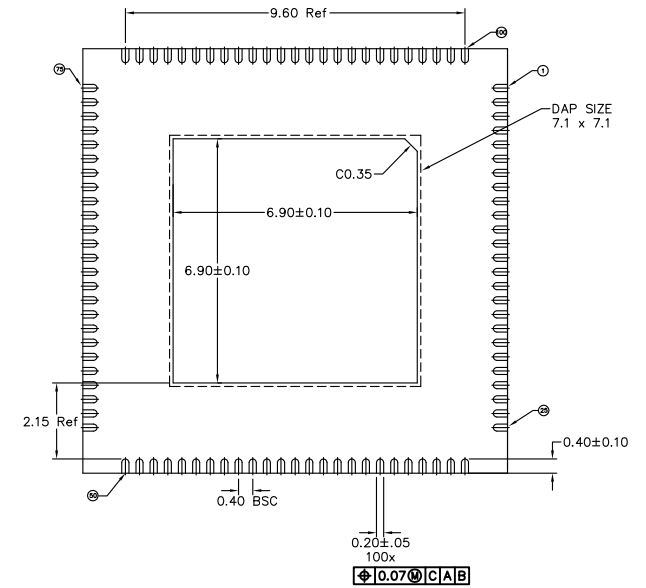
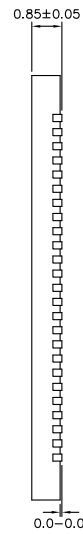
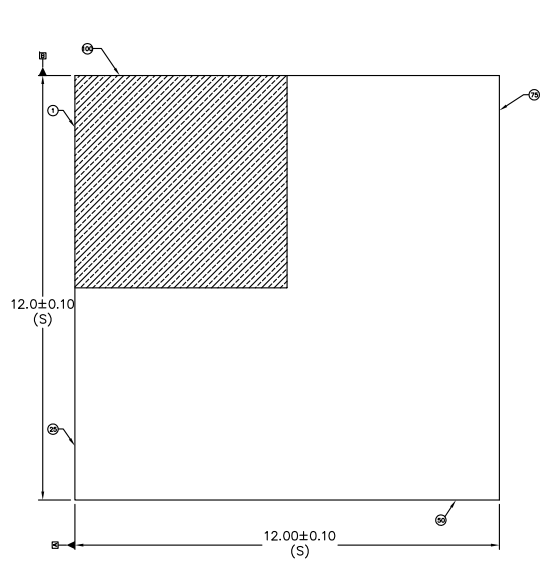

1. ALL DIMENSION ARE IN mm. ANGLES IN DEGREES.
2. COPLANARITY APPLIES TO THE EXPOSED PAD AS WELL AS THE TERMINALS.  
COPLANARITY SHALL NOT EXCEED 0.08 mm.
3. WARPAGE SHALL NOT EXCEED 0.10 mm.
4. PACKAGE LENGTH/ PACKAGE WIDTH ARE CONSIDERED AS SPECIAL CHARACTERISTIC. (S)
5. REFER TO JEDEC MO-220.

TOLERANCES UNLESS SPECIFIED			6024 Silver Creek Valley Road	
DECIMAL ANGULAR			San Jose, CA 95138	
X±		PHONE: (408) 284-8200		
XX±		FAX: (408) 284-8591		
XXX±		www.IDT.com		
APPROVALS	DATE	TITLE NL/NLG100 PACKAGE OUTLINE		
DRAWN <i>BAC</i>	01/11/16	12.0 x 12.0 mm BODY, SAWN		
CHECKED		EPAD 6.90 x 6.90 mm QFN		
		SIZE	DRAWING No.	REV
		C	PSC-4286-01	00
DO NOT SCALE DRAWING				SHEET 1 OF 4

REVISIONS			
REV	DESCRIPTION	DATE	APPROVED
00	INITIAL RELEASE	01/11/16	JH









SYMBOL	DIMENSIONS			NOTE
	MIN.	NOM.	MAX.	
A	0.80	0.85	0.90	
A1	0.00	0.01	0.05	10
A2	0.60	0.65	0.70	
A3	0.20 REF.			
D	12.00 BSC			
E	12.00 BSC			
@	0.40 BSC			
N	100			3
Nd	25			3
Ne	25			3
L	0.30	0.40	0.50	
b	0.15	0.20	0.25	4,12
D2	6.80	6.90	7.00	
E2	6.80	6.90	7.00	

GENERAL ; NOMINAL EXPOSED PAD(D2/E2) DIMENSION = NOMINAL DIE ATTACH PAD DIMENSION-0.20



TOLERANCES UNLESS SPECIFIED		 <b>IDT™</b> www.IDT.com	6024 Silver Creek Valley Road San Jose, CA 95138 PHONE: (408) 284-8200 FAX: (408) 284-8591	
DECIMAL	ANGULAR			
X±				
XX±				
XXX±				
APPROVALS	DATE	TITLE NL/NLG100 PACKAGE OUTLINE		
DRAWN <i>RAC</i>	01/11/16	12.0 x 12.0 mm BODY, SAWN EPAD 6.90 x 6.90 mm QFN		
CHECKED		SIZE	DRAWING No.	REV
		C	PSC-4286-01	00
DO NOT SCALE DRAWING			SHEET 2 OF 4	

REVISIONS			
REV	DESCRIPTION	DATE	APPROVED
00	INITIAL RELEASE	01/11/16	JH

- NOTES:
- DIE THICKNESS ALLOWABLE IS 0.305mm MAXIMUM(.012 INCHES MAXIMUM)
  - DIMENSIONING & TOLERANCES CONFORM TO ASME Y14.5M. – 1994.
  - N IS THE NUMBER OF TERMINALS.  
Nd IS THE NUMBER OF TERMINALS IN X-DIRECTION &  
Ne IS THE NUMBER OF TERMINALS IN Y-DIRECTION.
  -  DIMENSION b APPLIES TO PLATED TERMINAL AND IS MEASURED BETWEEN 0.15 AND 0.30mm FROM TERMINAL TIP.
  -  THE PIN #1 IDENTIFIER MUST BE EXISTED ON THE TOP SURFACE OF THE PACKAGE BY USING INDENTATION MARK OR OTHER FEATURE OF PACKAGE BODY.
  -  EXACT SHAPE AND SIZE OF THIS FEATURE IS OPTIONAL.
  - ALL DIMENSIONS ARE IN MILLIMETERS.
  -  THE SHAPE SHOWN ON FOUR CORNERS ARE NOT ACTUAL I/O.
  -  BILATERAL COPLANARITY ZONE APPLIES TO THE EXPOSED PAD AS WELL AS THE TERMINALS.
  -  APPLIED ONLY FOR TERMINALS.
  -  Q AND R APPLIES ONLY FOR STRAGHT TIEBAR SHAPES.
  -  FOR 0.40mm LEAD PITCH, THE LEAD POSITION TOLERANCE MUST BE 0.07mm AT THE ACTUAL MEAN VALUE OF BODY SIZE.
  - MOLD FLASH OR PLATING COVERAGE ON THE RING PAD AREA SHALL BE ALLOWABLE

TOLERANCES UNLESS SPECIFIED		 <b>6024 Silver Creek Valley Road</b> <b>San Jose, CA 95138</b> <b>PHONE: (408) 284-8200</b> <b>FAX: (408) 284-8591</b>		
DECIMAL	ANGULAR			
X±		<b>www.IDT.com</b>		
XX±				
XXX±				
APPROVALS	DATE	TITLE		
DRAWN <i>RAC</i>	01/11/16	NL/NLG100 PACKAGE OUTLINE		
CHECKED		12.0 x 12.0 mm BODY , SAWN EPAD 6.90 x 6.90 mm QFN		
		SIZE	DRAWING No.	REV
		C	PSC-4286-01	00
DO NOT SCALE DRAWING			SHEET 3 OF 4	

REVISIONS			
REV	DESCRIPTION	DATE	APPROVED
00	INITIAL RELEASE	01/11/16	JH

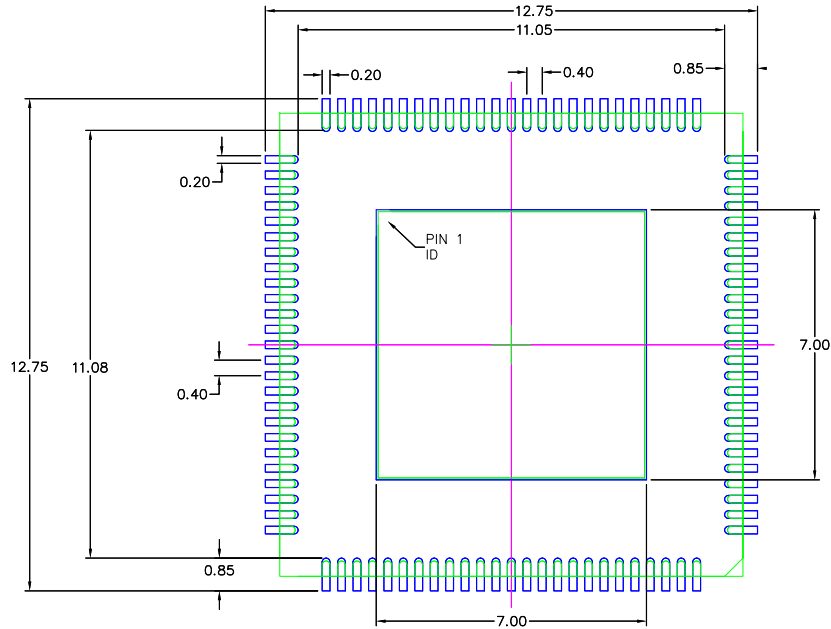

RECOMMENDED LAND PATTERN DIMENSION

NOTES:

1. ALL DIMENSIONS ARE IN mm. ANGLES IN DEGREES.
2. TOP DOWN VIEW. AS VIEWED ON PCB.
3. COMPONENT OUTLINE SHOWS FOR REFERENCE IN GREEN.
4. LAND PATTERN IN BLUE. NSMD PATTERN ASSUMED.
5. LAND PATTERN RECOMMENDATION PER IPC-7351B GENERIC REQUIREMENT FOR SURFACE MOUNT DESIGN AND LAND PATTERN.

TOLERANCES UNLESS SPECIFIED		 <b>IDT™</b> <a href="http://www.IDT.com">www.IDT.com</a>	6024 Silver Creek Valley Road San Jose, CA 95138 PHONE: (408) 284-8200 FAX: (408) 284-8591	
DECIMAL	ANGULAR			
X±				
XX±				
XXX±				
APPROVALS	DATE	TITLE NL/NLG100 PACKAGE OUTLINE		
DRAWN <i>BAC</i>	01/11/16	12.0 x 12.0 mm BODY, SAWN EPAD 6.90 x 6.90 mm QFN		
CHECKED		SIZE	DRAWING No.	REV
		C	PSC-4286-01	00
DO NOT SCALE DRAWING				SHEET 4 OF 4