

TOP VIEW

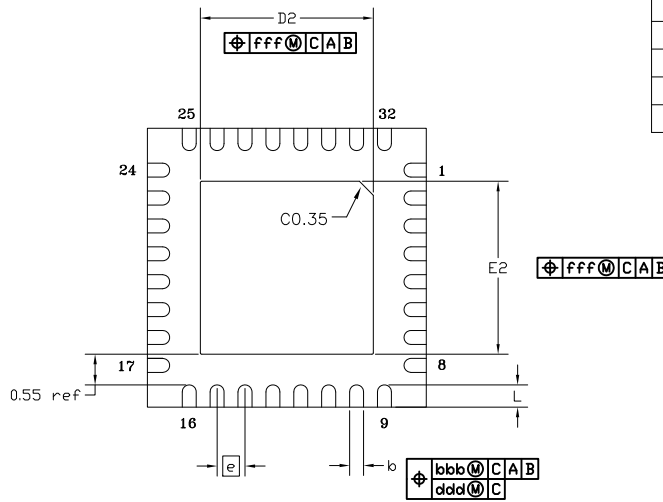

BOTTOM VIEW

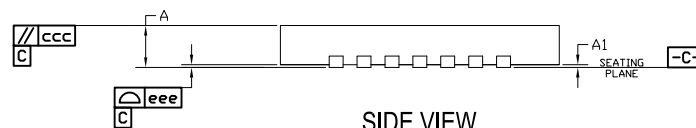

SIDE VIEW

EPAD OPTION

SYMBOL	P1			P2			P3		
	MIN	NOM	MAX	MIN	NOM	MAX	MIN	NOM	MAX
E2	3.00	3.10	3.20	3.10	3.30	3.40	3.60	3.70	3.80
D2	3.00	3.10	3.20	3.10	3.30	3.40	3.60	3.70	3.80

NOTES:

1. ALL DIMENSIONING AND TOLERANCING CONFORM TO ANSI Y14.5M-1982
2. ALL DIMENSIONS ARE IN MILLIMETERS.

REVISIONS			
REV	DESCRIPTION	DATE	APPROVED
00	INITIAL RELEASE	03/23/11	JG
01	COMBINE POD and LAND PATTERN	4/1/13	RC
02	ADD NOTE RECOMMENDED LAND PATTERN	2/25/14	J.H
03	ADD EPAD OPTION & aaa tol change	4/17/14	J.H
04	ADD EPAD OPTION	12/11/14	CM

SYMBOL	DIMENSION		
	MIN	NOM	MAX
L	0.30	0.40	0.50
D	5.00 BSC		
E	5.00 BSC		
e	0.50 BSC		
A	0.70	0.75	0.80
A1	0.00	0.02	0.05
b	.20	.25	.30
aaa	0.10		
bbb	0.10		
ccc	0.10		
ddd	0.05		
eee	0.08		
fff	0.10		

TOLERANCES UNLESS SPECIFIED DECIMAL ANGULAR X± .1 ±1° XX± .05 XXX± .030		 6024 SILVER CREEK VALLEY ROAD. SAN JOSE, CA 95138 PHONE: (408) 284-8200 FAX: (408) 284-3572 <a href="http://www.IDT.com">www.IDT.com</a>	
APPROVALS	DATE		
DRAWN <i>js</i>	03/23/11	SIZE	DRAWING No. PSC-4348
CHECKED		C	REV 04
		DO NOT SCALE DRAWING	
		SHEET 1 OF 2	

REVISIONS			
REV	DESCRIPTION	DATE	APPROVED
00	INITIAL RELEASE	03/23/11	JG
01	COMBINE POD and LAND PATTERN	4/1/13	RC
02	ADD NOTE RECOMMENDED LAND PATTERN	2/25/14	J.H
03	ADD EPAD OPTION & aaa tol change	4/17/14	J.H
04	ADD EPAD OPTION	12/11/14	CM

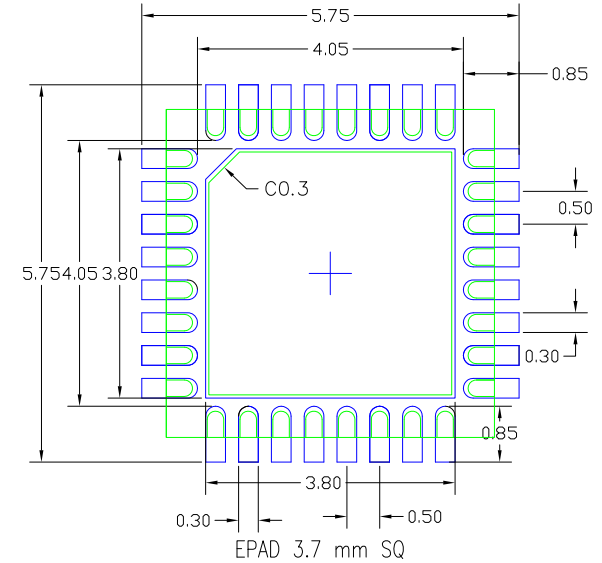
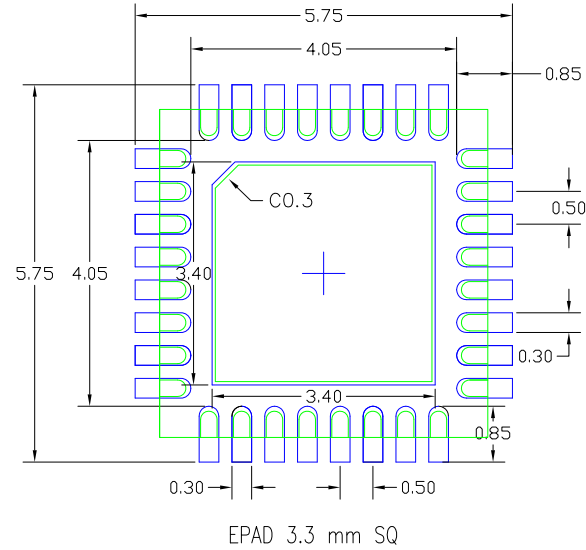
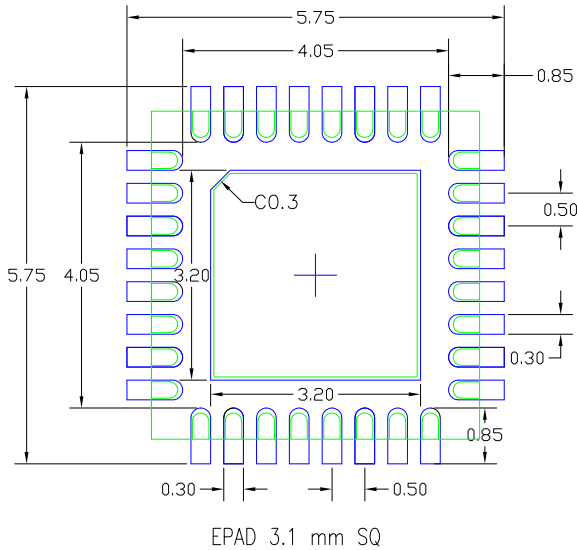

RECOMMENDED LAND PATTERN DIMENSION

NOTES:

1. ALL DIMENSION ARE IN mm. ANGLES IN DEGREES.
2. TOP DOWN VIEW, AS VIEWED ON PCB.
3. COMPONENT OUTLINE SHOW FOR REFERENCE IN GREEN.
4. LAND PATTERN IN BLUE. NSMD PATTERN ASSUMED.
5. LAND PATTERN RECOMMENDATION PER IPC-7351B GENERIC REQUIREMENT FOR SURFACE MOUNT DESIGN AND LAND PATTERN.

TOLERANCES UNLESS SPECIFIED		 <a href="http://www.IDT.com">www.IDT.com</a>	6024 SILVER CREEK VALLEY ROAD, SAN JOSE, CA 95138 PHONE: (408) 284-8200 FAX: (408) 284-3572	
DECIMAL	ANGULAR			
X ± .1	± 1°			
XX ± .05				
XXX ± .030				
APPROVALS	DATE	TITLE NB/NBG32 PACKAGE OUTLINE		
	03/23/11	5.0 x 5.0 mm BODY		
CHECKED		0.50 mm PITCH QFN		
		SIZE	DRAWING No.	REV
		C	PSC-4348	04
DO NOT SCALE DRAWING				SHEET 2 OF 2