

# Package Outline Drawing

L23.6.5x9

23 LEAD QUAD FLAT NO-LEAD PLASTIC PACKAGE

Rev 2, 10/15

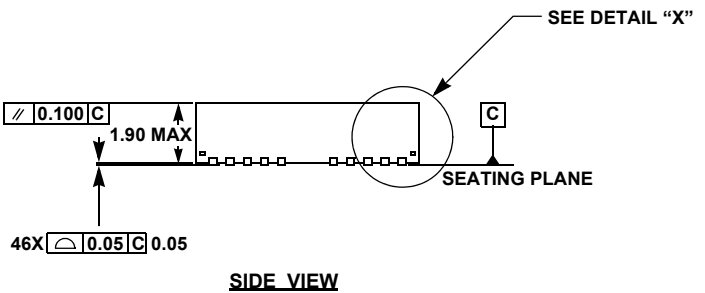
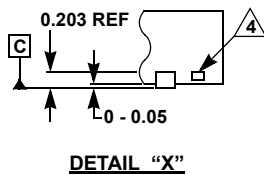
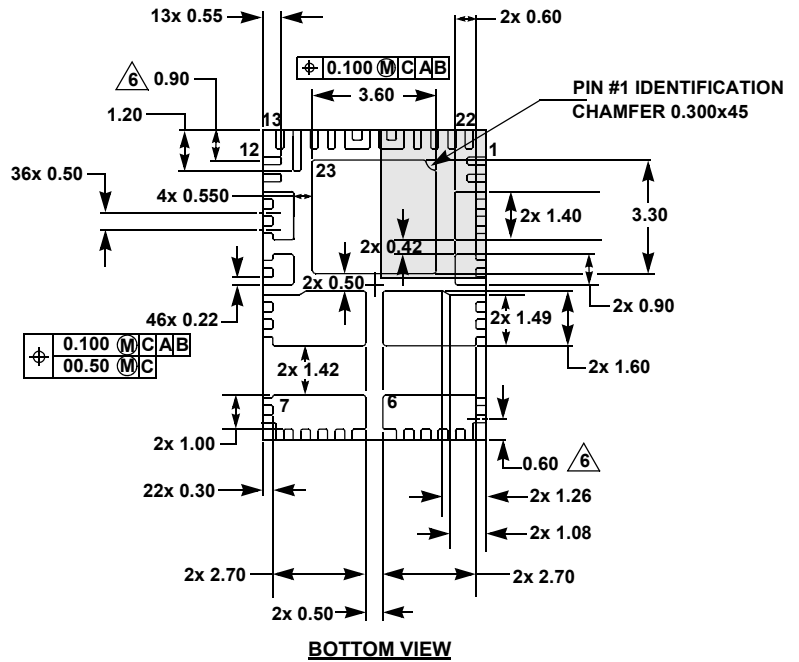
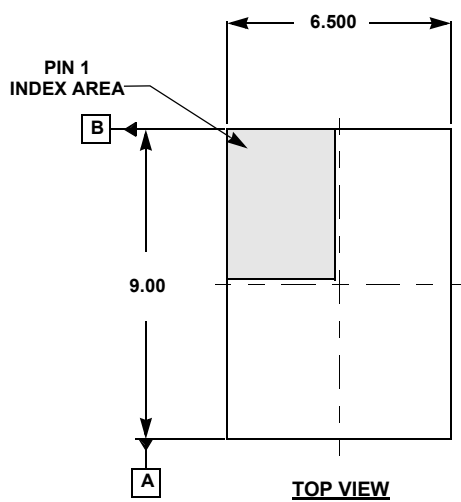

**NOTES:**

1. Dimensions are in millimeters.
2. Dimensioning and tolerancing conform to ASMEY 14.5m-1994.
3. Unless otherwise specified, tolerance: Decimal  $\pm 0.05$ .
4. Tiebar shown (if present) is a non-functional feature.
5. The configuration of the pin #1 identifier is optional, but must be located within the zone indicated. The pin #1 identifier may be either a mold or mark feature.
6. Lead pitches not centered in "y" direction.

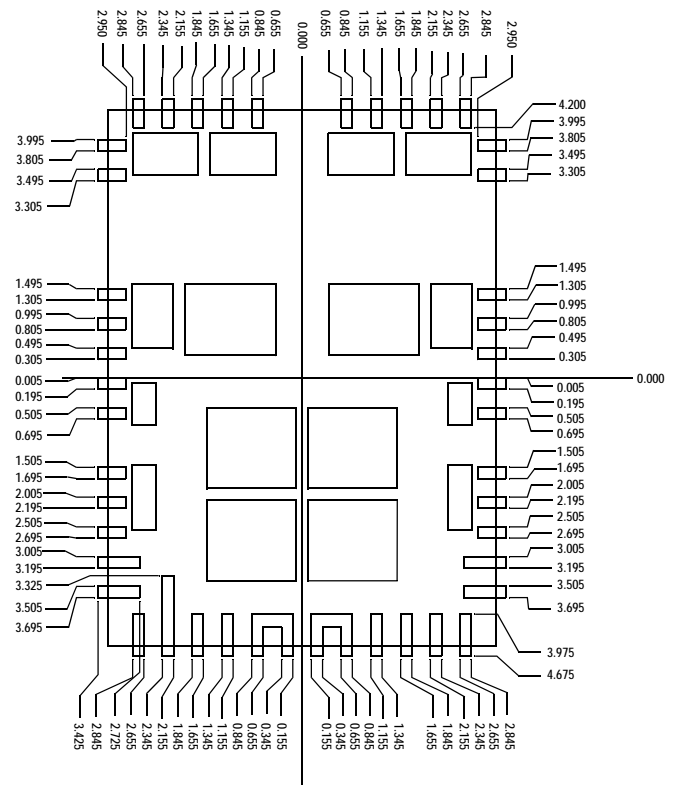

**STENCIL PATTERN WITH 23 MOSLP TOP VIEW**

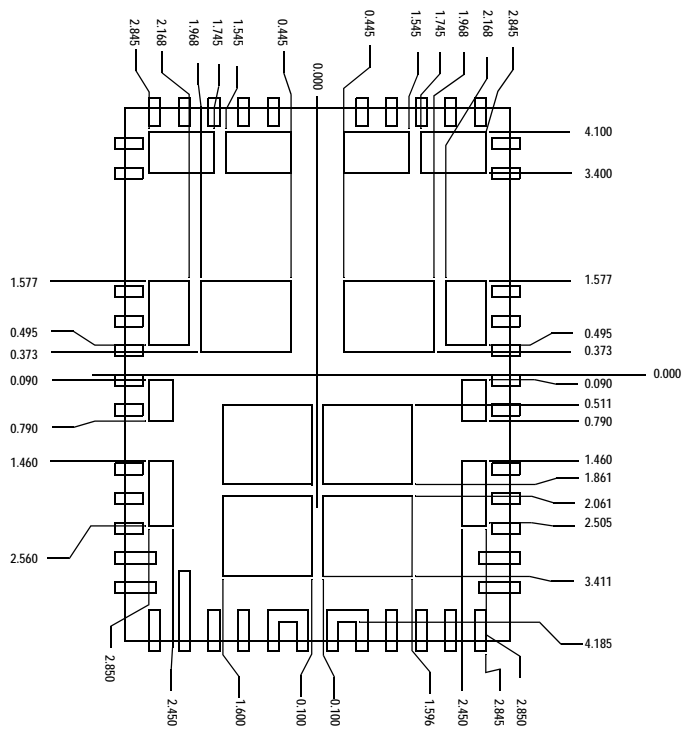

**STENCIL PATTERN WITH 23 MOSLP TOP VIEW**

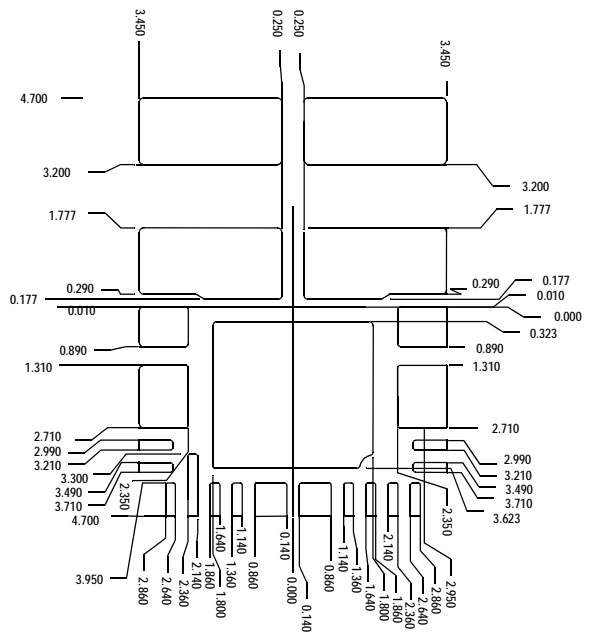

**TYPICAL RECOMMENDED LAND PATTERN**