

DATE CREATED		REVISIONS		
REV	DESCRIPTION	AUTHOR		
11/28/18	00	INITIAL RELEASE	VS	
NOTE: REFER TO DCP FOR OFFICIAL RELEASE DATE				

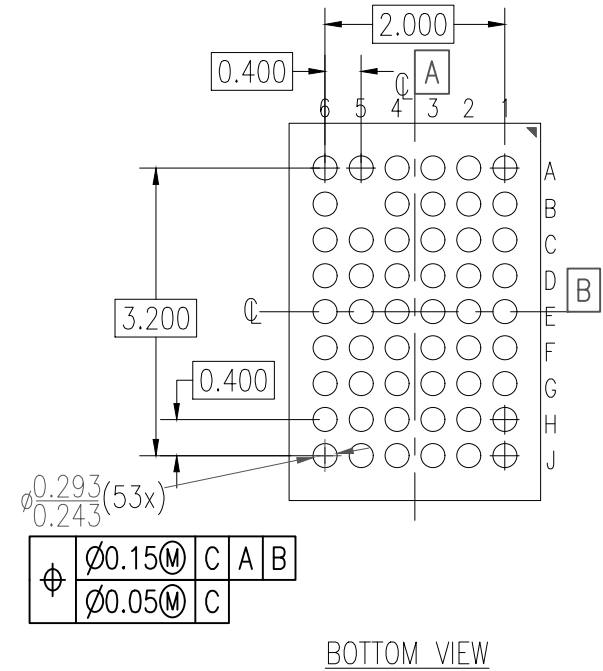
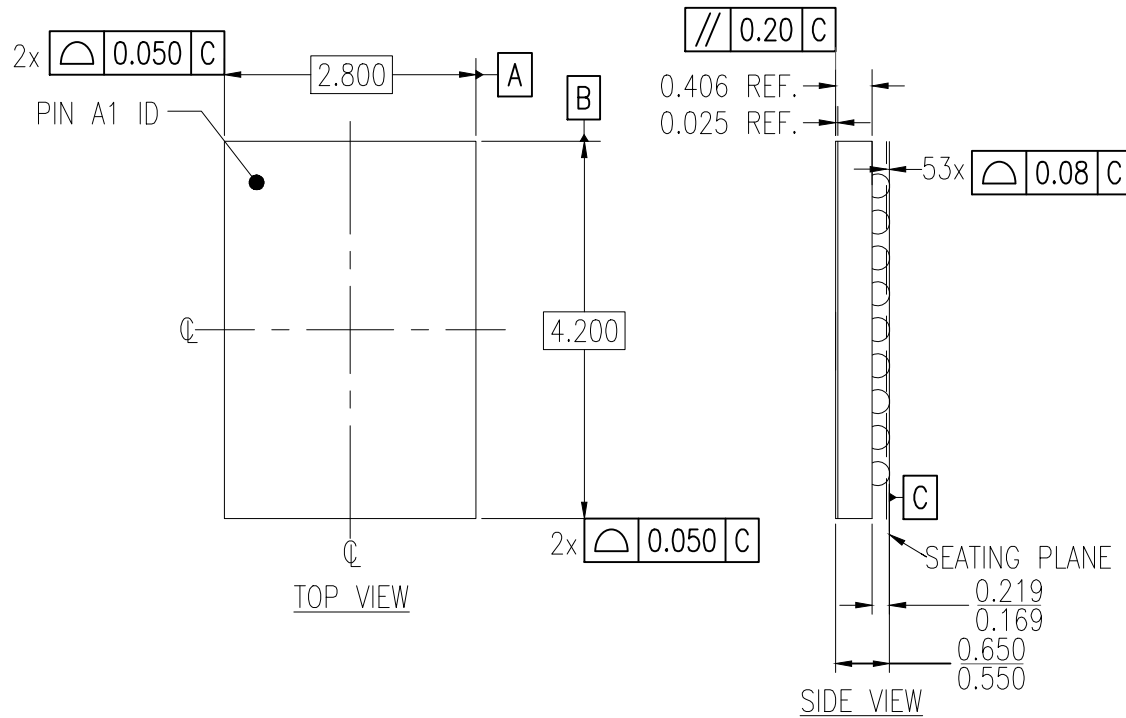

- NOTES:
1. ALL DIMENSIONS AND TOLERANCES ARE PER ASME Y14.5M-2009
 2. ALL DIMENSIONS ARE IN MILLIMETERS.

TOLERANCES UNLESS SPECIFIED DECIMAL ANGULAR XX± 0.05 ± XXX± 0.012 ± XXXX±		6024 SILVER CREEK VALLEY ROAD, SAN JOSE, CA 95138 PHONE: (408) 284-8200 FAX: (408) 284-3572	
		www.IDT.com	
TITLE AZR53 Package Outline Drawing 2.800 x 4.200 x 0.600 mm Body 0.4mm Pitch DSBGA			
SIZE C	DRAWING No. PSC-4783	REV 00	
DO NOT SCALE DRAWING			SHEET 1 OF 2

DATE		REVISIONS		
CREATED	REV	DESCRIPTION	AUTHOR	
11/28/18	00	INITIAL RELEASE	VS	
NOTE: REFER TO DCP FOR OFFICIAL RELEASE DATE				

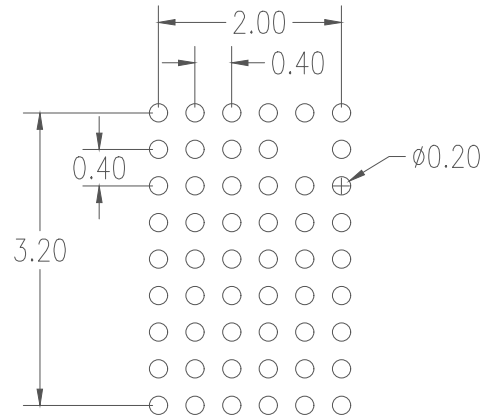

RECOMMENDED LAND PATTERN DIMENSION

NOTE:

1. ALL DIMENSIONS ARE IN MM, ANGLES IN DEGREES.
2. TOP DOWN VIEW, AS VIEW ON PCB.
3. NSMD LAND PATTERN ASSUMED.
4. LAND PATTERN RECOMMENDATION AS PER IPC-7351
GENERIC REQUIREMENT FOR SURFACE MOUNT DESIGN AND LAND PATTERN.

TOLERANCES UNLESS SPECIFIED		 IDT™ www.IDT.com	6024 SILVER CREEK VALLEY ROAD, SAN JOSE, CA 95138 PHONE: (408) 284-8200 FAX: (408) 284-3572		
DECIMAL	ANGULAR		TITLE AZR53 Package Outline Drawing 2.800 x 4.200 x 0.600 mm Body 0.4mm Pitch DSBGA		
XX± 0.05 ±			SIZE C	DRAWING No. PSC-4783	REV 00
XXX± 0.012 ±			DO NOT SCALE DRAWING SHEET 2 OF 2		