

Impedance Ratio	Mode	T5 PART NUMBER	T2 PART NUMBER	¹ FS Input Power (dBm)	R19, R21 (Ohms)	R19, R21 Vishay Part number	R16, R17	R18, R20
1:1 *	ISLA214P25	ADTL1-12+	DNP	10	27	CRCW040227R0FKED	DNP	0 Ohm
	ISLA214P50	ADTL1-12+	DNP	10	30	CRCW040230R0FKED	DNP	0 Ohm
	ISLA216P25	ADTL1-12+	DNP	10	30	CRCW040230R0FKED	DNP	0 Ohm
2:1 *	ISLA214P25	TX-2-5-1	DNP	13	13	CRCW040213R0FKED	DNP	0 Ohm
	ISLA214P50	TX-2-5-1	DNP	13	13.7	CRCW040213R7FKED	DNP	0 Ohm
	ISLA216P25	TX-2-5-1	DNP	13	13.7	CRCW040213R7FKED	DNP	0 Ohm
4:1	ISLA214P25	DNP	TC4-19G2+	16	6.34	CRCW04026R34FKED	0 Ohm	DNP
	ISLA214P50	DNP	TC4-19G2+	16	6.49	CRCW04026R49FKED	0 Ohm	DNP
	ISLA216P25	DNP	TC4-19G2+	16	6.49	CRCW04026R49FKED	0 Ohm	DNP
1:2	ISLA214P25	TX-2-5-1 BACKWARD	DNP	7	60.4	CRCW040260R4FKED	DNP	0 Ohm
	ISLA214P50	TX-2-5-1 BACKWARD	DNP	7	75	CRCW040275R0FKED	DNP	0 Ohm
	ISLA216P25	TX-2-5-1 BACKWARD	DNP	7	75	CRCW040275R0FKED	DNP	0 Ohm

* Default PCB Build

1 ADC Input FS - Neglects 3-4dB Input Network Loss

ISLA216IR72EV1Z Schematics

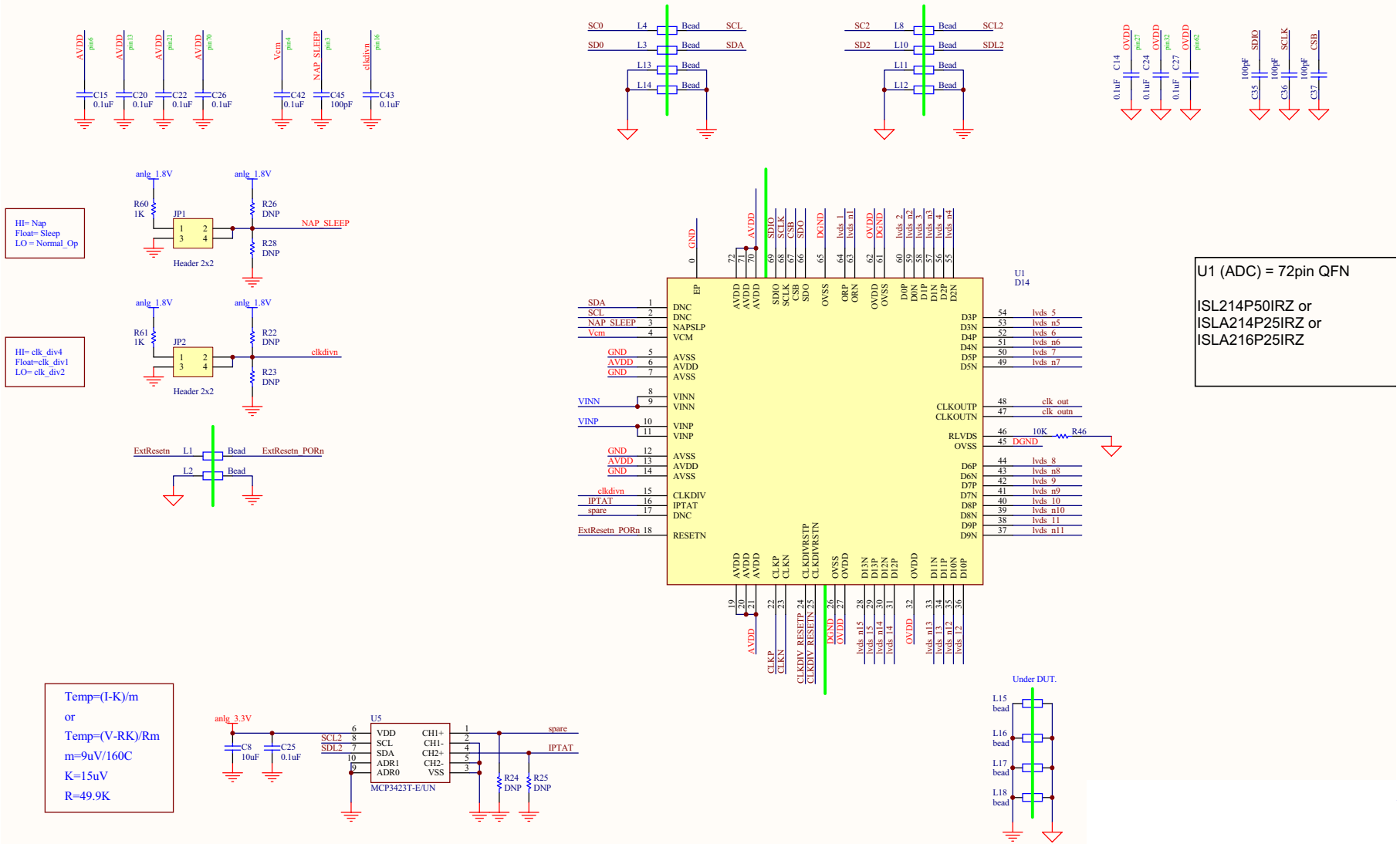

FIGURE 1. ADC

ISLA216IR72EV1Z

U1 (ADC) = 72pin QFN
 ISLA214P50IRZ or
 ISLA214P25IRZ or
 ISLA216P25IRZ

ISLA216IR72EV1Z Schematics (Continued)

Sampling Clock	Populate	Depopulate
LVC MOS	C28, C29	C38, C39
LVDS	C38, C39	C28, C29

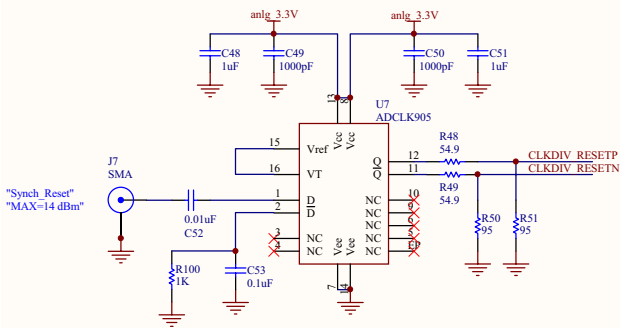
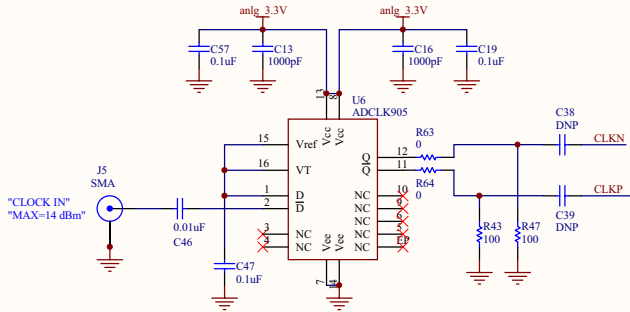
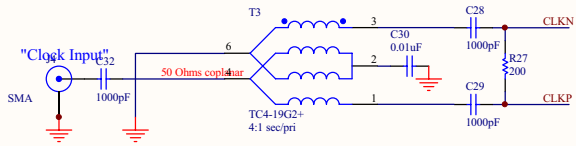

R100 was added to rev B pcb
Rev B pcb also Cut trace at C53

DNP AT2, T1, T2

Optional Path

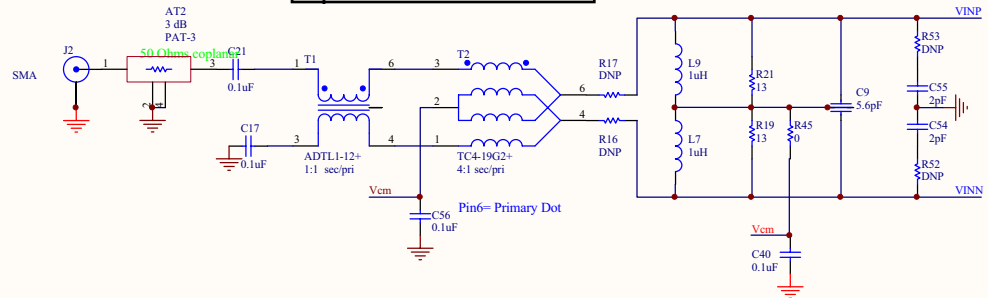

"Analog Input"

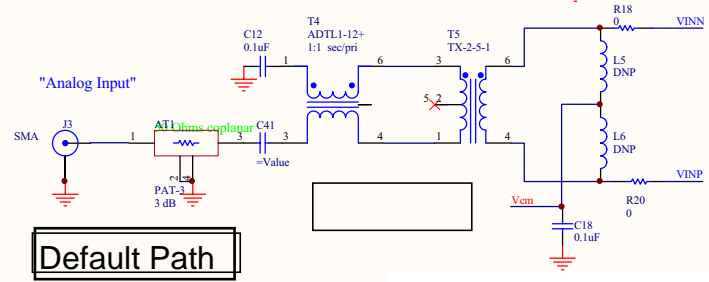

Default Path

FIGURE 2. ANALOG FRONT END, CLOCK, SYNC RESET

ISLA216IR72EV1Z Schematics (Continued)

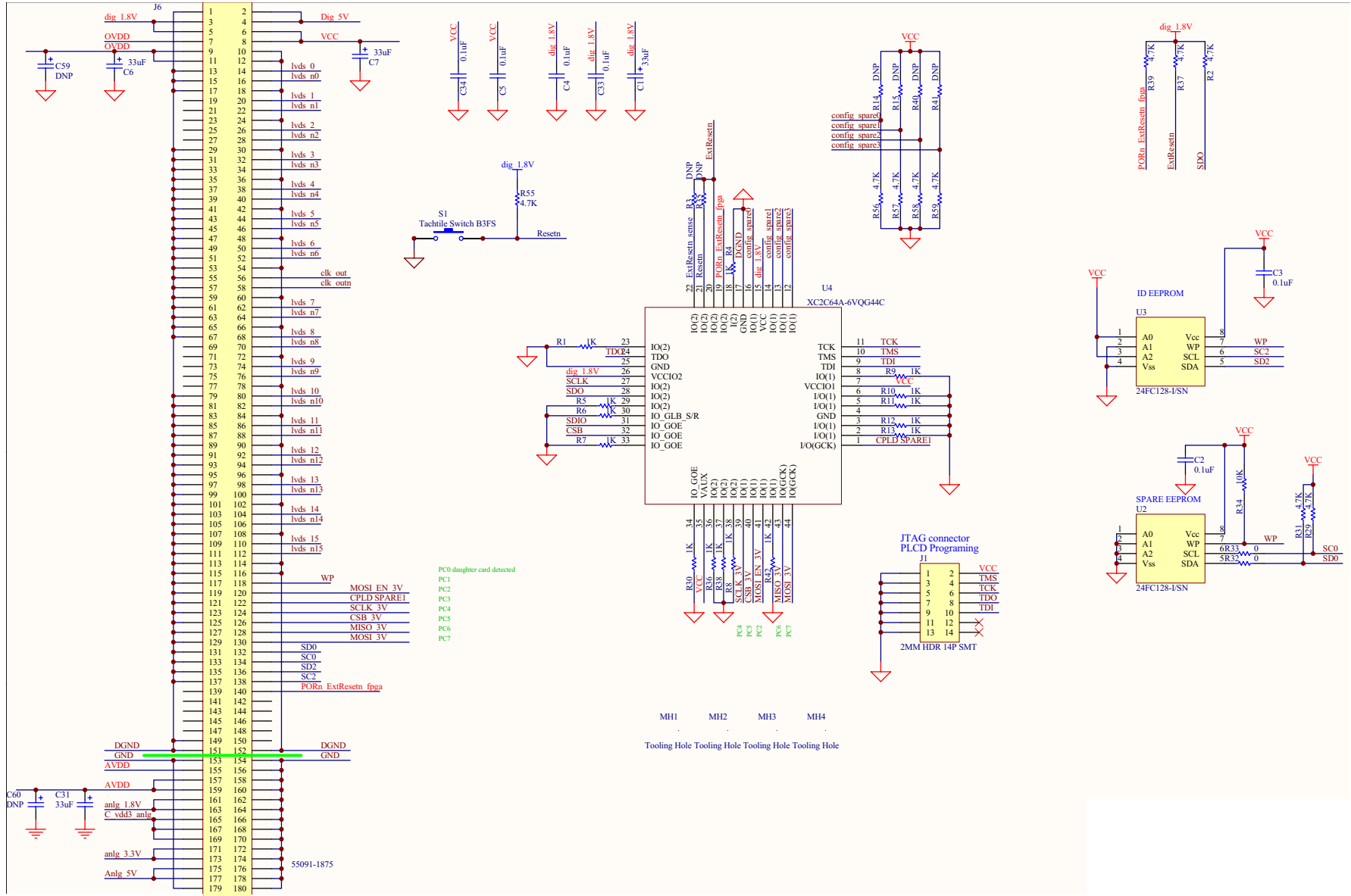

FIGURE 3. IO LEVEL TRANSLATOR ID PROM

ISLA216IR72EV1Z

ISLA216IR72EV1Z Layers

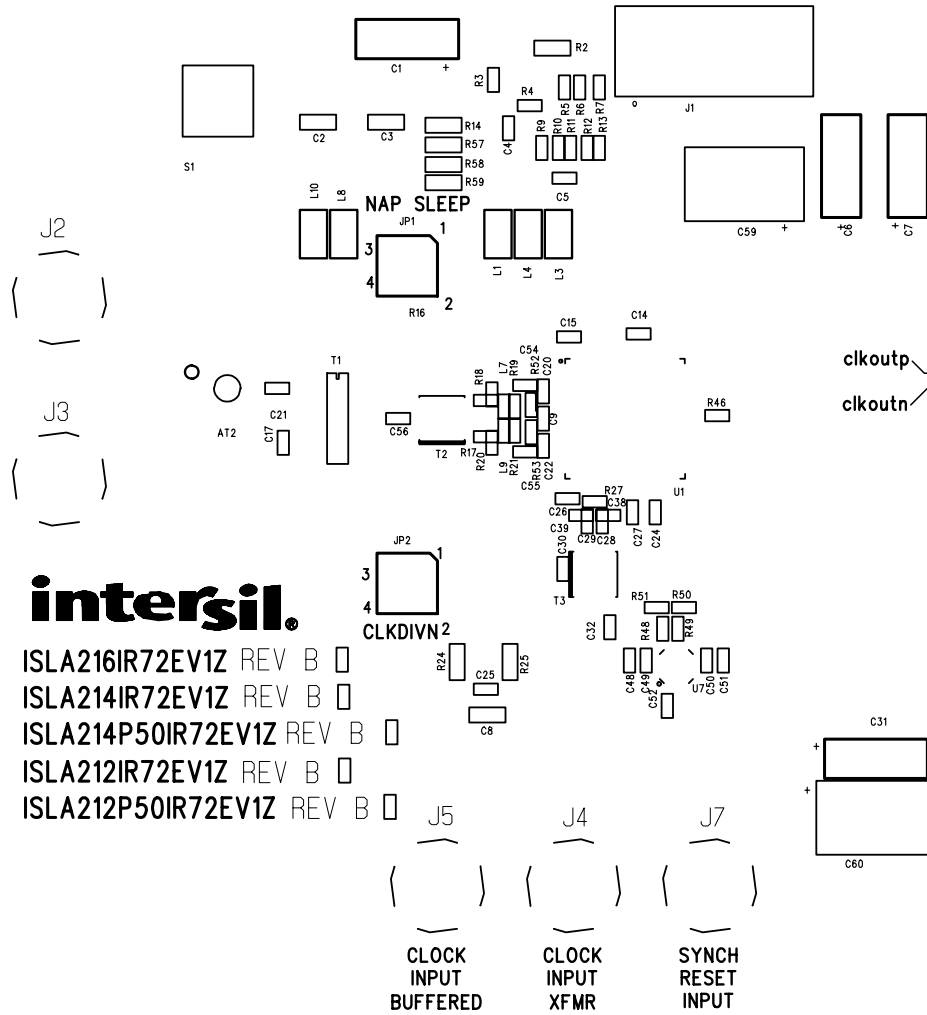

FIGURE 4. TOP SILKSCREEN

ISLA216IR72EV1Z Layers (Continued)

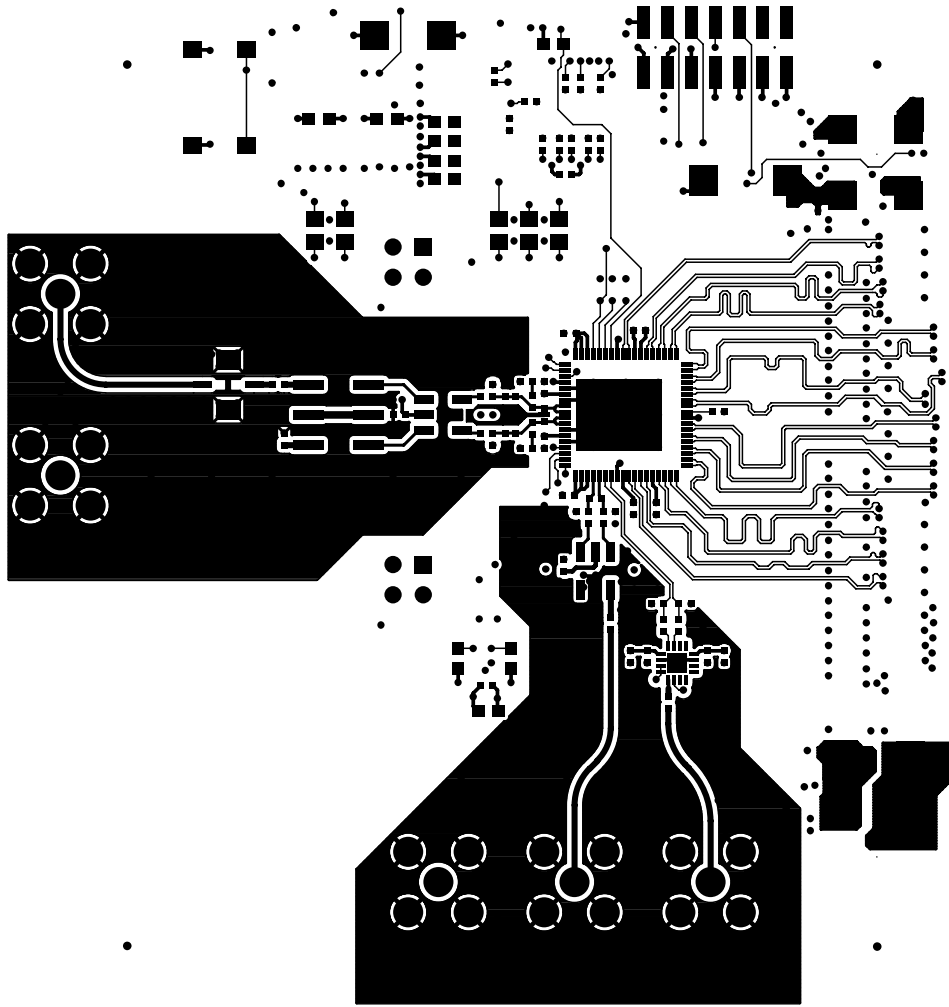

FIGURE 5. TOP LAYER ROUTING

ISLA216IR72EV1Z Layers (Continued)

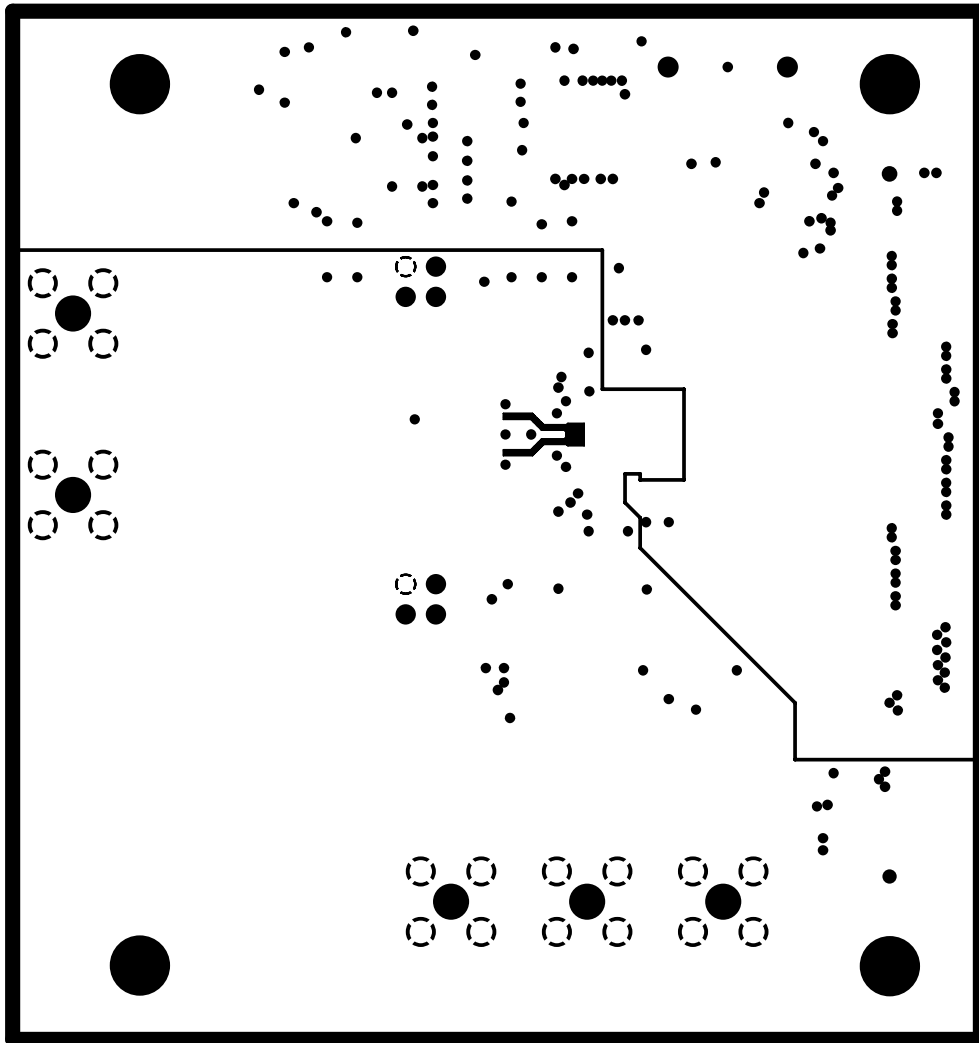

FIGURE 6. SPLIT GROUND PLANE

ISLA216IR72EV1Z Layers (Continued)

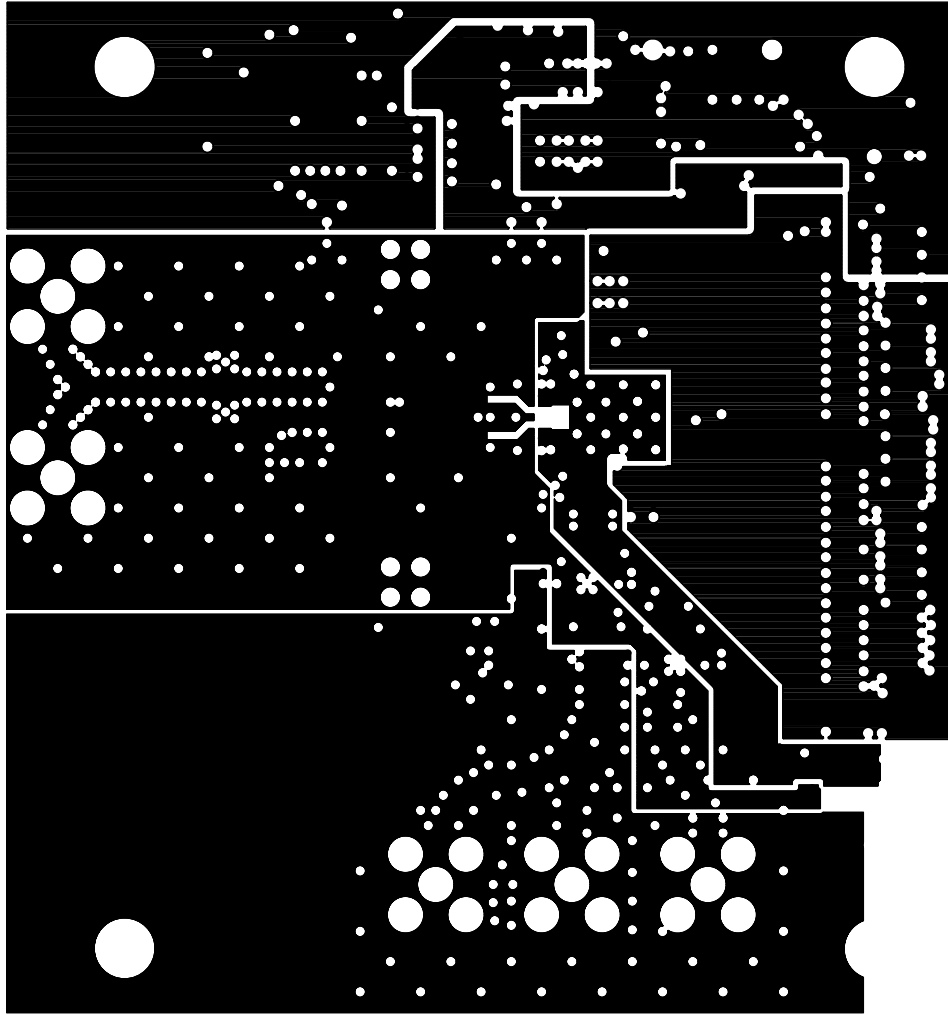

FIGURE 7. SPLIT POWER PLANE

ISLA216IR72EV1Z Layers (Continued)

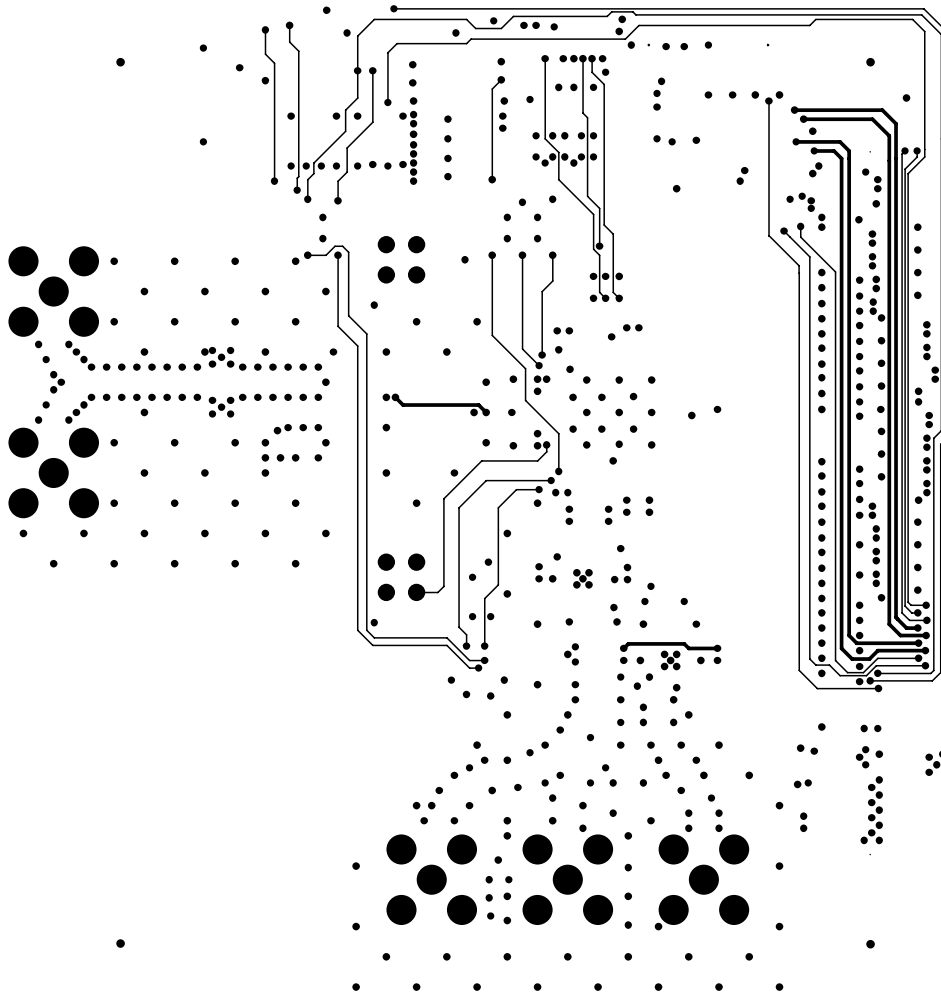

FIGURE 8. INNER LAYER ROUTING

ISLA216IR72EV1Z Layers (Continued)

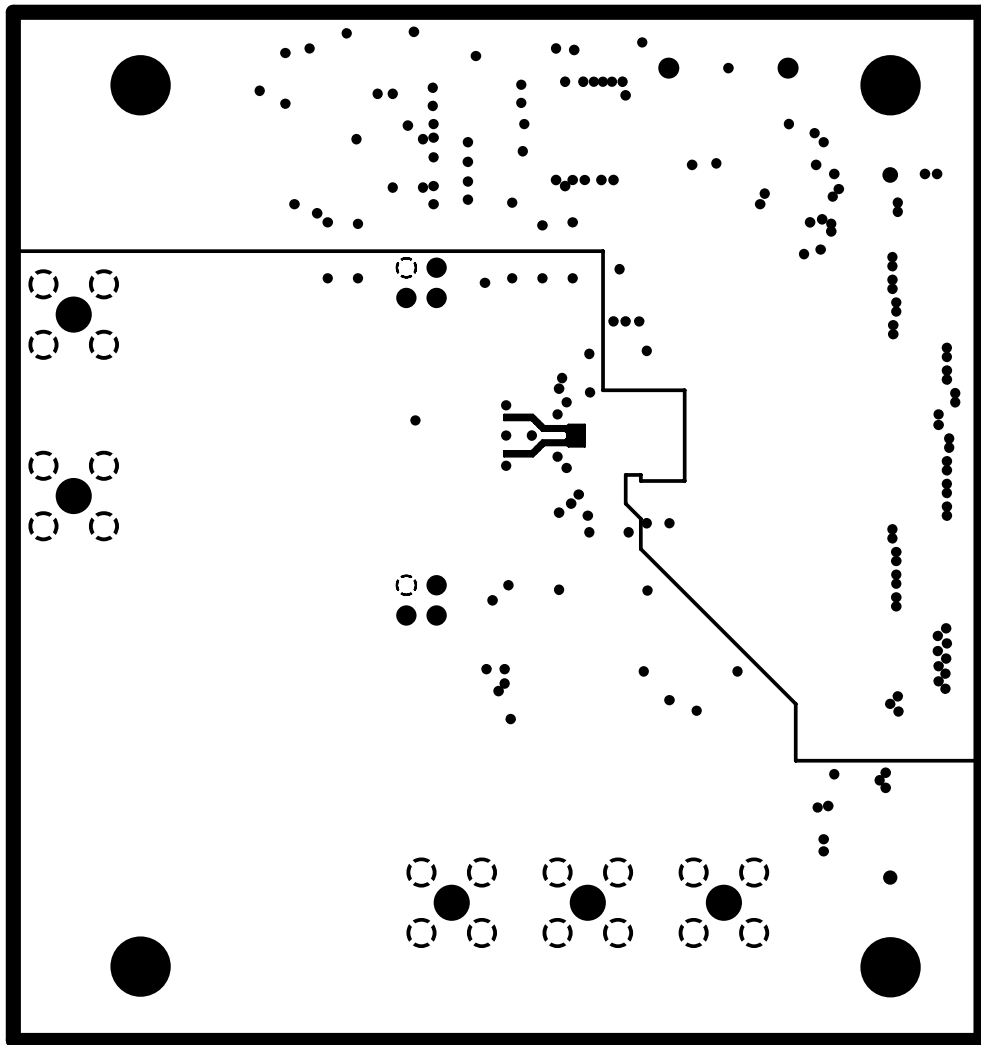

FIGURE 9. 2ND SPLIT GROUND PLANE

ISLA216IR72EV1Z Layers (Continued)

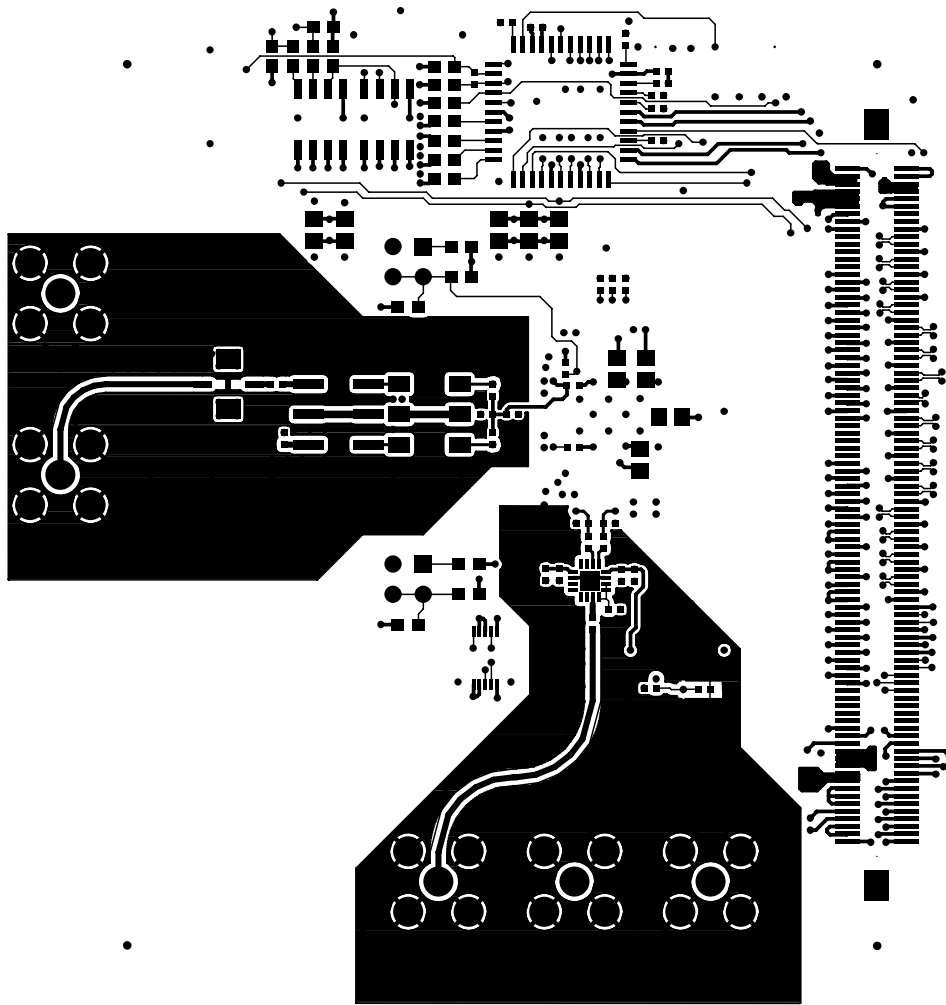

FIGURE 10. BOTTOM LAYER ROUTING

ISLA216IR72EV1Z

ISLA216IR72EV1Z Layers (Continued)

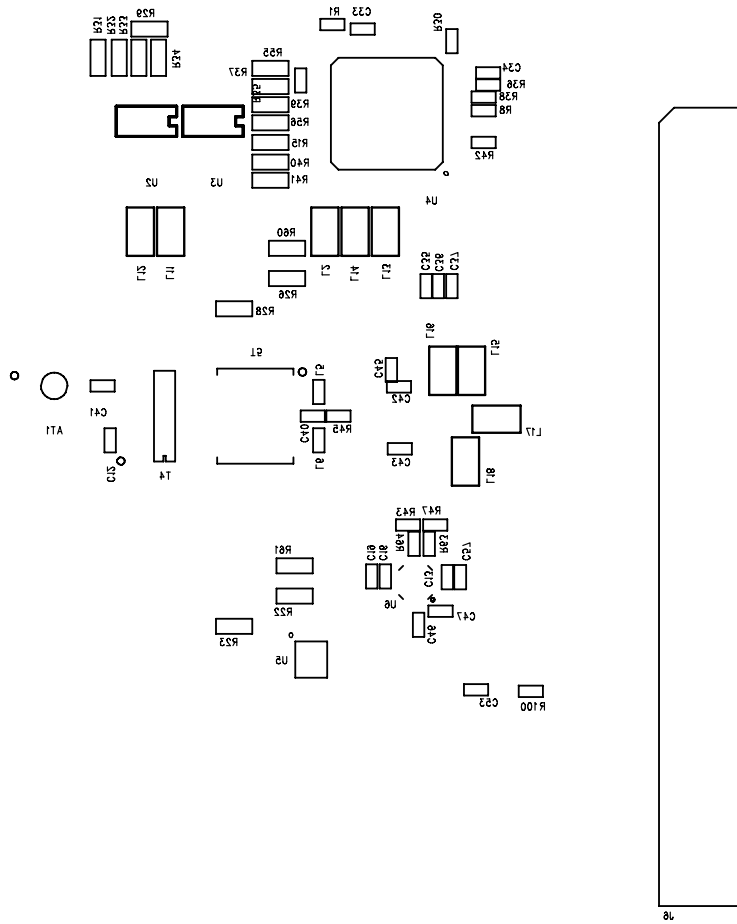

FIGURE 11. BOTTOM SILKSCREEN

Intersil Corporation reserves the right to make changes in circuit design, software and/or specifications at any time without notice. Accordingly, the reader is cautioned to verify that the Application Note or Technical Brief is current before proceeding.

For information regarding Intersil Corporation and its products, see www.intersil.com