

Renesas EEPROM Product Outline

April 3, 2024

Standard Memory Products Section,
Standard Products Department, Standard Products Division,
Analog & Connectivity Product Group,
Renesas Electronics Corporation

EEPROM-2024-E-0403-1

Memory Products Portfolio

■ “One-Renesas” provides optimum memory solutions to various application fields

Memory Types	Products	Sources
Low Power SRAM	<ul style="list-style-type: none"> ■ (5V, 3V) 256Kb, 1Mb, 4Mb ■ (3V) 2Mb, 8Mb, 16Mb, 32Mb, 64Mb 	Renesas
Asynchronous Fast SRAM	<ul style="list-style-type: none"> ■ (5V, 3.3V) 4Mb ■ (5V) 16Kb, 64Kb, 256Kb ■ (5V, 3.3V) 1Mb ■ (3.3V) 4Mb 	former IDT
Synchronous SRAM	<ul style="list-style-type: none"> ■ Pipeline Burst / Flow-through : 4Mb, 9Mb ■ Zero Bus Turnaround (ZBT) : 4Mb, 9Mb, 18Mb 	former IDT
Specialty Memory	<ul style="list-style-type: none"> ■ Multi-Port (5V, 3.3V, 2.5V) 8Kb ~ 36Mb ■ FIFO (5V, 3.3V, 2.5V) 2Kb ~ 9Mb 	former IDT
EEPROM	<ul style="list-style-type: none"> ■ Serial I/F: I2C, SPI (1.8V ~ 5.5V) 2Kb ~ 512Kb 	Renesas
SPI NOR Flash	<ul style="list-style-type: none"> ■ Standard Products: (1.8V) 8Mb ~ 128Mb (3V) 256Kb ~ 128Mb (1.8 ~ 3V, Wide Vcc) 256Kb ~ 32Mb ■ System-Enhancing Products: Fusion / FusionHD 512Kb~32Mb / DataFlash 2Mb~64Mb / Ultra-Low Energy 1Mb~4Mb 	former Dialog

Covered by this Material

Advantages: Renesas EEPROM

1. High reliability by MONOS technology

- ✓ More than 30 years of production, from 3um-process to date
- ✓ Distinguished Erase/Write endurance

2. Stable supply and long-term support

- ✓ PLP (Product Longevity Program) Applicable*

3. Wide variety of product lineup

- ✓ Serial EEPROM : 2Kb to 512Kb for both I²C and SPI

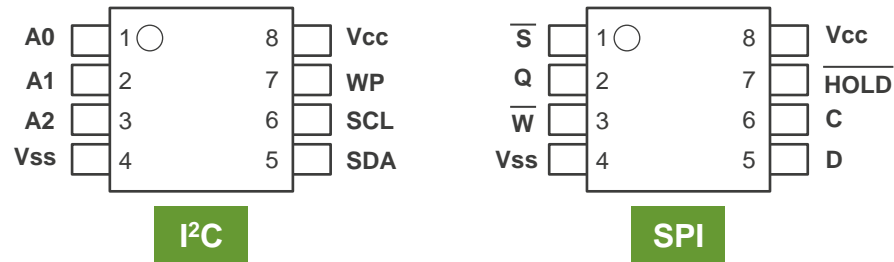

Pin Arrangement : 8-pin SOP / 8-pin TSSOP (Top View)



Product **Longevity** Program







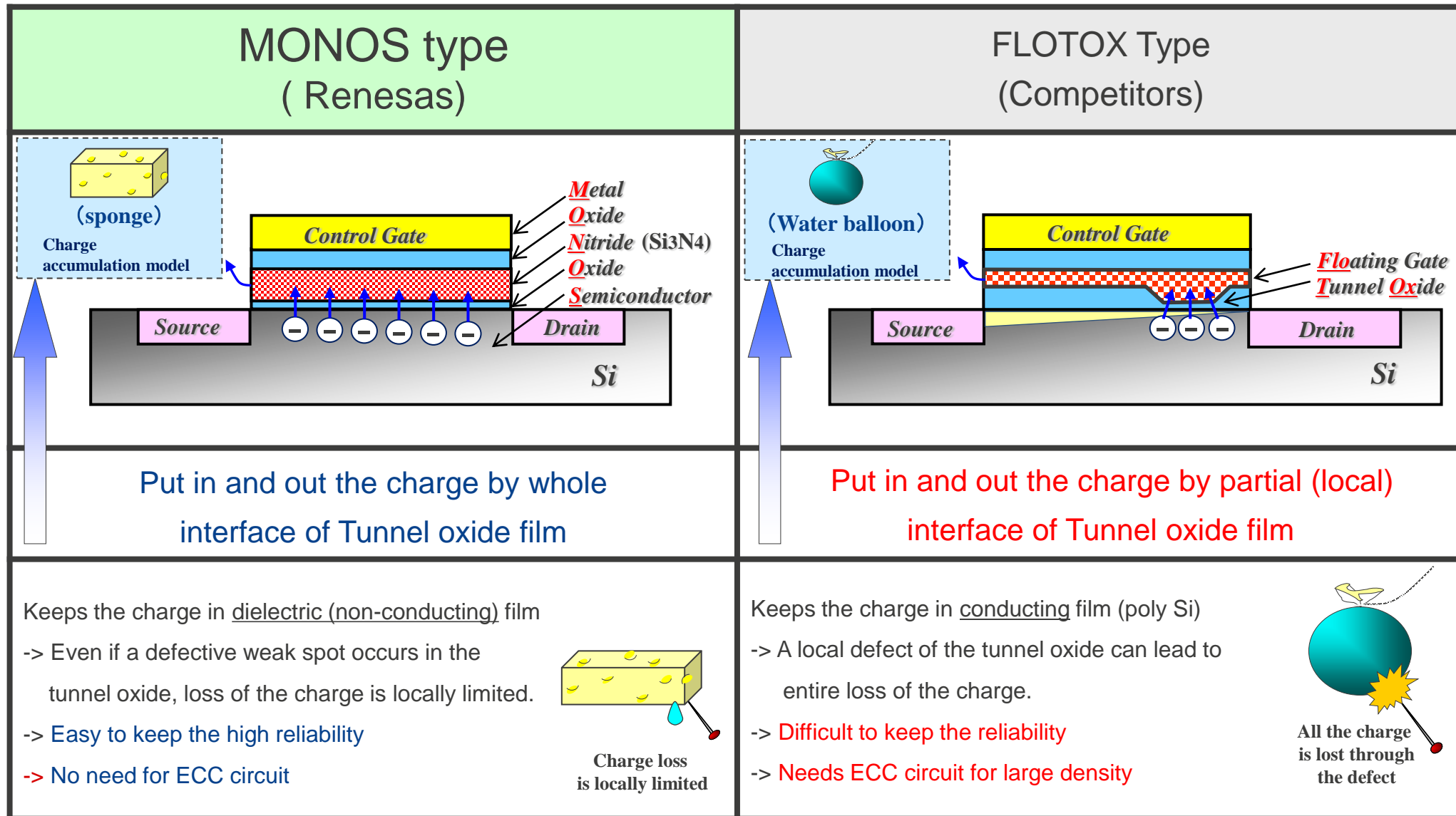

* Contact us for the applicable part names.



High Reliability of MONOS type



EEPROM Applications

Industrial					Consumer			
Factory automation	Energy system	Communication infrastructure	POS system	Car accessory (non-driveline) Navigation, etc.	Healthcare equipment	Consumer electronics	Office automation apparatus	Gaming
								

Track Records of Renesas EEPROM

★ Use case by application/density

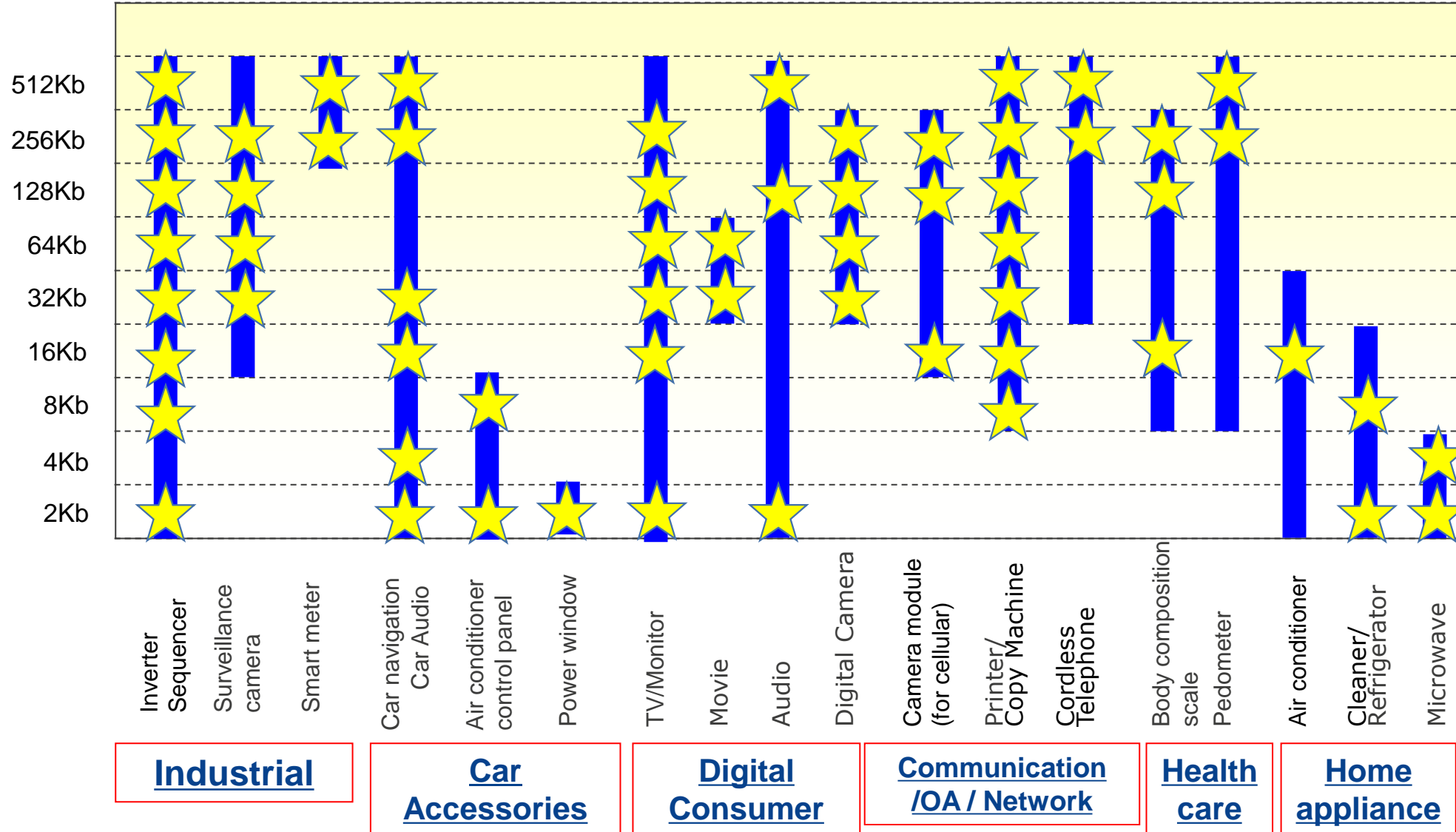

Winning Combinations

Winning combinations to accelerate
your application design

Analog + Power + Embedded Processing + Connectivity



Application	EEPROM Product	Renesas Website
Smart Pen	R1EX24002ASAS0I	Smart Pen Renesas
Single-Board Computer (SBC) Solution Featuring RZ/G2L MPU	R1EX24002ASAS0I	Single-board Computer (SBC) Solution Featuring RZ/G2L MPU Renesas
Wireless Electronic Gaming Table	R1EX24016ASAS0I	Wireless Electronic Gaming Table Renesas
Gigabit Industrial Ethernet System-on-Module	R1EX24016ASAS0I	Gigabit Industrial Ethernet System-on-Module (SoM) Solution Renesas
High Throughput Wi-Fi 6 Router	R1EX24016ATAS0I	High Throughput Wi-Fi 6 Router Renesas
1-Phase power meter	R1EX25512ATA00I	1-Phase Power Meter Renesas

Renesas EEPROM in smart pen

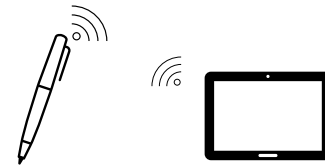

- The LED and detector record's the pen's movement
- The IR LED is invisible, so the user will not be distracted by any light while writing
- Bluetooth® Low Energy (LE) on the pen would transfer the digital data from the pen to a computer or tablet
- An EEPROM on board will store the writing in memory for transfer to a notebook
- Buttons for audio recording to start and to power on/off the pen

This smart pen system is used to record human handwriting and store a copy in a digital format. The pen uses one IR LED to emit light onto the paper and an LED sensor to detect the reflection. The sensor will allow the movement of the pen's pattern to be detected and record what is written.

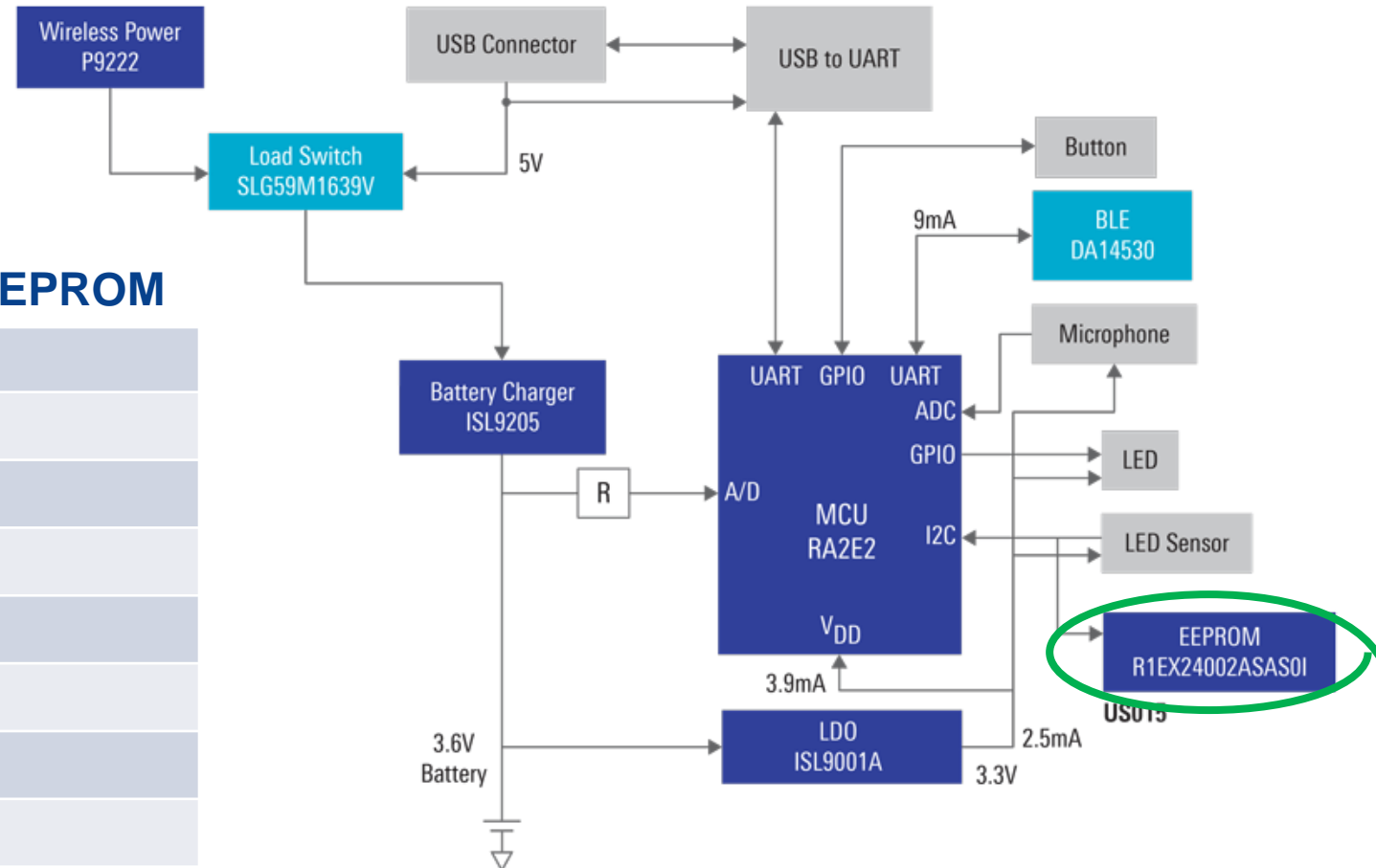

Packed with Renesas content including EEPROM

Renesas Part	Type
DA14530	Low Power BLE
R1EX24002ASAS0I	EEPROM
ISL9001A	LDO
SLG59M1639V	Switch
RA2E2	Microcontroller
ISL9205	Battery Charger
ISL920	Power Receiver

2 Wire Interface - Easy to Implement Serial EEPROM Lineup (I²C)

Part Name (Product Series)	Density	Interface	Package (pinout)		Max Clock	Operating Voltage	Operating Temperature	Erase/Write Endurance (cycles)
			SOP (8)	TSSOP (8)				
R1EX24002A	2Kb	I2C	✓	✓	400KHz	1.8 V ~ 5.5 V	-40°C ~ 85°C	1,000K (25°C) 100K (85°C)
R1EX24004A	4Kb	I2C	✓	✓				
R1EX24008A	8Kb	I2C	✓	✓				
R1EX24016A	16Kb	I2C	✓	✓				
R1EX24032A	32Kb	I2C	✓	✓				
R1EX24064A	64Kb	I2C	✓	✓				
R1EX24128B	128Kb	I2C	✓	✓	400KHz	1.8 V ~ 5.5 V	-40°C ~ 85°C	1,000K
R1EX24256B	256Kb	I2C	✓	✓	1MHz*Note	1.8 V ~ 5.5 V	-40°C ~ 85°C	1,000K
R1EX24512B	512Kb	I2C	✓	✓				

*Note: 1MHz (2.5V ~ 5.5V) / 400KHz (1.8V ~ 5.5V)

With Faster Interface

Serial EEPROM Lineup (SPI)

Part Name (Product Series)	Density	Interface	Package (pinout)		Max Clock	Operating Voltage	Operating Temperature	Erase/Write Endurance (cycles)
			SOP (8)	TSSOP (8)				
R1EX25002A	2Kb	SPI	✓	✓	5MHz*Note	1.8 V ~ 5.5 V	-40°C ~ 85°C	1,000K (25°C) 100K (85°C)
R1EX25004A	4Kb	SPI	✓	✓				
R1EX25008A	8Kb	SPI	✓	✓				
R1EX25016A	16Kb	SPI	✓	✓				
R1EX25032A	32Kb	SPI	✓	✓				
R1EX25064A	64Kb	SPI	✓	✓				
HN58X25128	128Kb	SPI	✓					
HN58X25256	256Kb	SPI	✓					
R1EX25512A	512Kb	SPI	✓	✓				

*Note: 5MHz (2.5V ~ 5.5V) / 3MHz (1.8V ~ 5.5V)

Serial EEPROM Part Name

R1E X 24 064 A SA S0 I #S0

RENESAS EEPROM

Operating Voltage

X	1.8 ~ 5.5V
V	2.5 ~ 5.5V

Interface

24	I2C
25	SPI

Memory Density

002	2Kb	128	128Kb
004	4Kb	256	256Kb
008	8Kb	512	512Kb
016	16Kb		
032	32Kb		
064	64Kb		

Chip Generation

A	A mask
B	B mask

Environmental / Packing specs

	Package Material		Tape & Reel (pcs / reel)	
			SOP (8)	TSSOP (8)
#S0	Pb-free	Au-wire	2,500	3,000
#U0	Pb-free, Halogen-free	Au-wire	2,500	3,000
#K0	Pb-free, Halogen-free	Cu-wire	4,000	

Operating Temperature

I	Industrial: -40 ~ 85°C
----------	------------------------

Function

S0	I2C
00	SPI

Package

SA	8pin SOP
TA	8pin TSSOP

[Renesas.com](https://www.renesas.com)