

RH850 Evaluation Platform

RH850/F1x 144-pin
RH850/R1x 144-pin

PiggyBack board V1

RH850-F1X-144PIN-PB-T1-V1

All information contained in these materials, including products and product specifications, represents information on the product at the time of publication and is subject to change by Renesas Electronics Corp. without notice. Please review the latest information published by Renesas Electronics Corp. through various means, including the Renesas Technology Corp. website (<http://www.renesas.com>).

Table of Contents

Chapter 1	Introduction	3
Chapter 2	Overview	4
2.1	Overview	4
2.2	Mounting of the device	5
Chapter 3	Power supply	6
3.1	Board power connection	6
3.2	Voltage distribution.....	7
Chapter 4	Clock sources.....	8
4.1.1	MainOsc.....	8
4.1.2	SubOSC	8
Chapter 5	Debug and Programming interface	9
Chapter 6	Connectors for ports of device.....	10
6.1	Push button for RESET.....	10
6.2	Connectors to MainBoard.....	10
6.2.1	Connector CN1.....	10
6.2.2	Connector CN2.....	12
6.2.3	Connector CN3.....	13
Chapter 7	Precautions.....	15
7.1	CAN1 signals for R1L.....	15
Chapter 8	Mechanical dimensions	16
Chapter 9	Schematic	17
Chapter 10	Revision History	20

Chapter 1 Introduction

The RH850/F1x Application Board is part of the RH850 Evaluation Platform and serves as a simple and easy to use platform for evaluating the features and performance of Renesas Electronics 32-bit RH850/F1x microcontrollers. The piggyback board (RH850-F1X-144PIN-PB-T1-V1) can be used as a standalone board, or can be mated with a mainboard (e.g. RH850-X1X-MB-T1-V1) for extended functionality.

Main features:

- Socket for mounting of device
- Standalone operation of the board
- Direct supply of device voltage (typ. 3.3V-5.0V)
- Device programming capability
- Device debugging capability
- Pin headers for direct access to each device pin
- Reset switch
- MainOSC and SubOSC circuitry
- Connectors to MainBoard

This document describes the functionality provided by the piggyback board and guides the user through its operation.

For details regarding the operation of the microcontroller, refer to the RH850/F1L or RH850/R1x User's Manual.

Chapter 2 Overview

2.1 Overview

Figures 1 and 2 provide the views of the Piggyback Board.

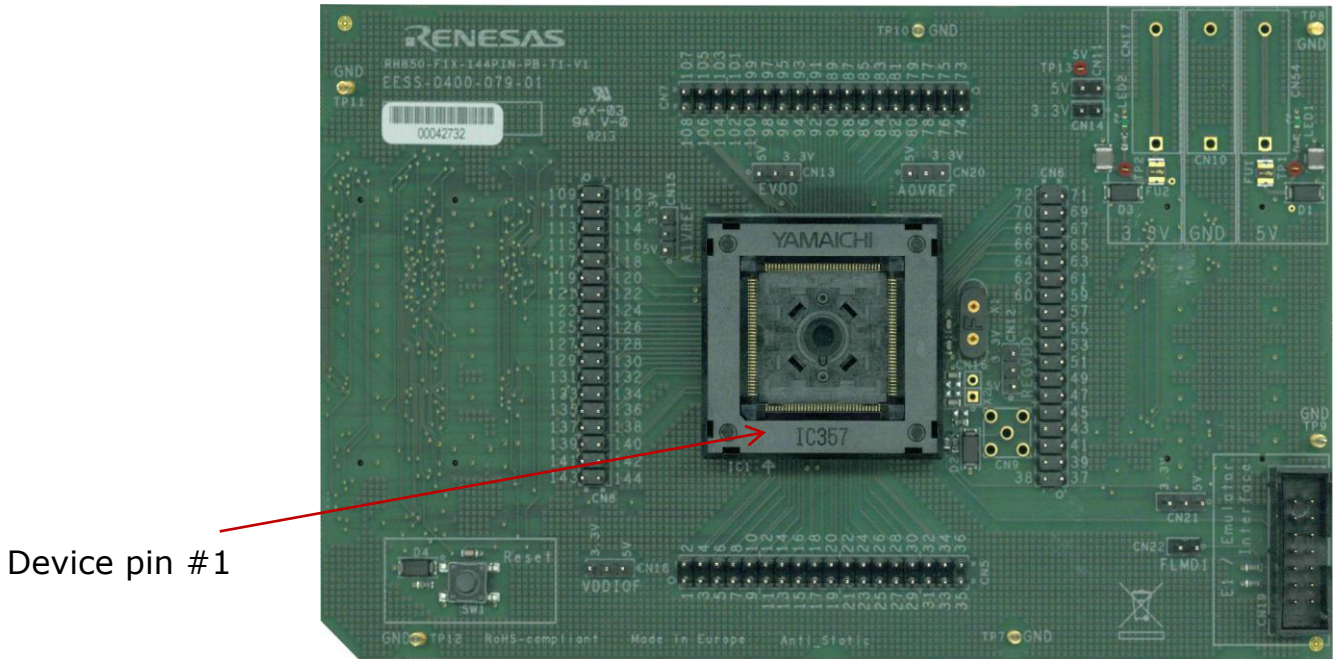

Figure 1 – PiggyBoard top view

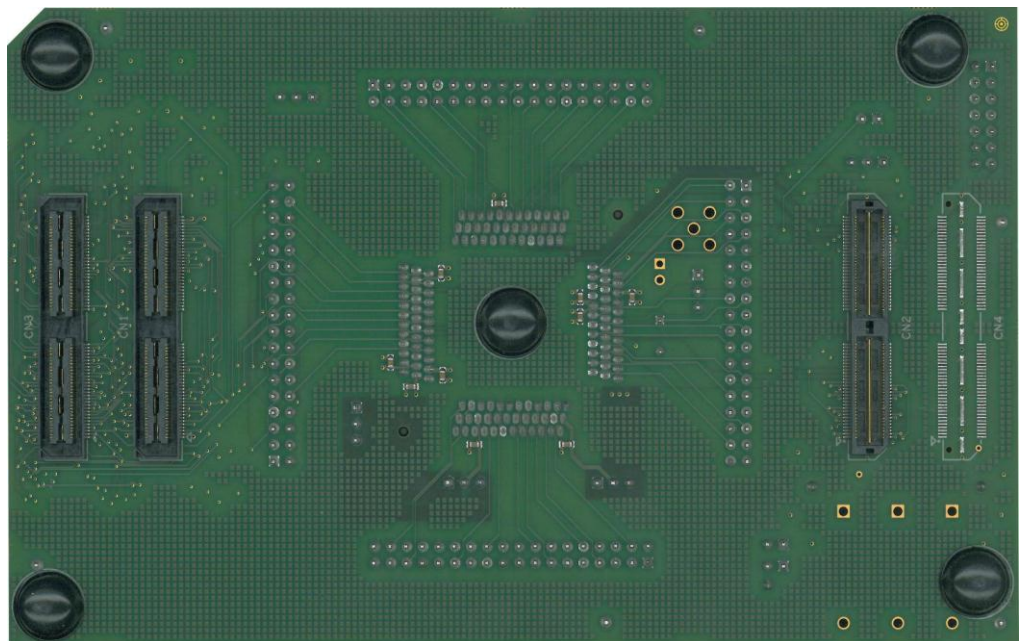

Figure 2 – PiggyBoard bottom view

2.2

Mounting of the device

The board is designed for use with the following device:

RH850/F1L 144-pin
RH850/R1L 144-pin

The device must be placed inside the socket IC1. To insert the device, press down the lid, align the #1 pin of the device to the #1 pin of the socket, insert the device inside the socket and release the lid.

Chapter 3 Power supply

3.1 Board power connection

For operation of the device, a supply voltage must be connected to the board. Though a single supply voltage is sufficient for the operation of the device, two (different) voltages can be supplied to the board.

Within this document the following voltages are considered as 'typical' connections:

Voltage1 = 5.0V

Voltage2 = 3.3V

The following connectors are available to supply those voltages:

- Three 4mm 'banana-type' connectors:
 - Two red connectors for voltages *Voltage1* (CN54) and *Voltage2* (CN17).
 - A black connector for VSS connection (CN10).

Note: The three connectors are supplied with the board but not assembled.
- The E1 emulator, that is used for debug purposes and flash programming, can also supply a single operating voltage ('Dbg_Voltage'). The voltage is programmable via the E1 GUI as 3.3 or 5.0V (typ). See the documentation of the E1 and chapter 5 'Debug and Programming interface' for details.
- In case the PiggyBoard is mounted on a MainBoard, the voltages *Voltage1* and *Voltage2* are supplied by the on-board regulators of the MainBoard.

NOTE: Do not supply any voltage directly to the PiggyBoard in case it is mounted on the MainBoard.

For each of the two voltages, 'Voltage 1' and 'Voltage 2', a green LED (LED1 and LED2) is available to signal that the related voltage is available on the PiggyBoard.

3.2 Voltage distribution

The table shows the required device power supply pins and their function:

Device supply pin	Function
REGVDD	Supply for the device <u>internal regulators</u> for the digital logic.
EVDD	Supply for <u>ports</u> of AWO and ISO area.
A0VREF	Supply for <u>ports</u> and <u>analog functions</u> of ADC0.
A1VREF	Supply for <u>ports</u> and <u>analog functions</u> of ADC1.

Additional one power supply for MainBoard can be selected:

Supply voltage	Function
VDDIOF	IO supply voltage for components located on a connected mainboard.

- For each of the above voltages, the voltage source can be selected from *Voltage1* (typ. 5.0V) or *Voltage2* (typ. 3.3V) by the jumpers CN12, CN13, CN15 and CN20.
- The IO supply voltage for the Mainboard (VDDIOF) can be selected via jumper CN18 from either the Voltage1 or the Voltage2.

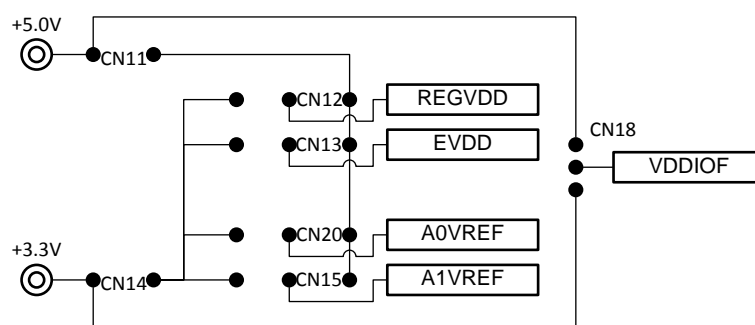

Chapter 4 Clock sources

Two external crystal oscillators for the device clock supply are provided with the board.

4.1.1 MainOsc

A crystal or ceramic resonator in the range of 8MHz to 24MHz can be mounted on socket X1.

A 8MHz and 16Mhz oscillator is supplied with the board.

4.1.2 SubOSC

An oscillator with a frequency of 32.768kHz is supplied with the board and can be soldered into the connector CN16.

Chapter 5 Debug and Programming interface

For connection of the microcontroller debug and flash programming tools, the connector CN19 is provided.

The signal connection of the connector CN19 is shown in the picture below:

CN19 pin	Device Port	Device signal
1	JP0_2	DCUTCK / LPDCLK
2	GND	GND
3	JP0_4	DCUTRST
4	FLMD0	FLMD0
5	JP0_1	DCUTDO / LPDO
6	-	-
7	JP0_0	DCUTDI / LPDI
8	'Dbg_Voltage'	-
9	JP0_3	DCUTMS
10	-	-
11	JP0_5	DCURDY / LPDCLKOUT
12	GND	-
13	RESET	-
14	GND	-

In case of connecting a debug/programming tool to CN19, the pin header CN22 must be closed.

The 'Dbg_Voltage' (on CN19 pin 8) is monitored or supplied by the debug and flash programming tools. Therefore, it is necessary to select either Voltage1 (5V) or the Voltage2 (3.3V) by pin header CN21:

CN21 pin	Selection for Dbg_Voltage
1-2	5V is selected
2-3	3.3V is selected

Chapter 6 Connectors for ports of device

Connection to each pin of the device is possible via the connectors CN5 to CN8.

Note :The pin headers are directly connected to the pins, therefore special care must be taken to avoid any electrostatic or other damage to the device.

6.1 Push button for RESET

In order to issue a RESET to the device, the push-button SW1 is available.

6.2 Connectors to MainBoard

Three connectors (CN1 to CN3) are available to connect the PiggyBoard to a MainBoard.

The signal connection of each connector is described in the following tables:

6.2.1 Connector CN1

Pin	Function	Device Port	Pin	Function	Device Port
1	VOLTAGE1	-	2	VOLTAGE1	-
3	VOLTAGE1	-	4	VOLTAGE1	-
5	RESET	_RESET	6	NMI	P9_0
7	WAKE	-	8	-	-
9	INT0	P9_1	10	INT1	P0_6
11	INT2	P9_2	12	INT3	P9_3
13	-	-	14	-	-
15	UART0TX	P10_10	16	UART1TX	P0_5
17	UART0RX	P10_9	18	UART1RX	P0_4
19	LIN0TX	P10_10	20	LIN1TX	P0_8
21	LIN0RX	P10_9	22	LIN1RX	P0_7
23	IIC0SDL	P10_3	24	IIC1SDL	-
25	IIC0SDA	P10_2	26	IIC1SDA	-
27	CAN0TX	P10_1	28	CAN1TX	P0_3
29	CAN0RX	P10_0	30	CAN1RX	P0_2
31	SENTIN0	-	32	SENTIN1	-
33	SENTOUT0	-	34	SENTOUT1	-
35	PSI50Rx	-	36	PSI51Rx	-
37	PSI50Tx	-	38	PSI51Tx	-
39	PSI50Sync	-	40	PSI51Sync	-
41	FLX0TX	P11_1	42	FLX0EN	P10_11
43	FLX0RX	P10_14	44	-	-
45	FLX1TX	P11_6	46	FX1EN	P10_13

47	FLX1RX	P11_5		48	-	-
49	-	-		50	-	-
51	ETH0MDIO	-		52	ETH0MDC	-
53	ETH0RXD0	-		54	EH0TXD0	-
55	ETH0RXD1	-		56	EH0TXD1	-
57	ETH0RXD2	-		58	EH0TXD2	-
59	ETH0RXD3	-		60	EH0TXD3	-
61	ETH0RXDCLK	-		62	ETH0TXCLK	-
63	ETH0RXER	-		64	ETH0TXER	-
65	ETH0CRSDV	-		66	ETH0TXEN	-
67	ETH0RXDV	-		68	ETH0COL	-
69	ETH0RESET	-		70	-	-
71	-	-		72	-	-
73	USB0UDMF	-		74	USB0UDMH	-
75	USB0UDPF	-		76	USB0UDPH	-
77	-	-		78	-	-
79	-	-		80	-	-
81	-	-		82	-	-
83	-	-		84	-	-
85	DIGIO_0	P8_0		86	DIGIO_1	P8_1
87	DIGIO_2	P8_2		88	DIGIO_3	P8_3
89	DIGIO_4	P8_4		90	DIGIO_5	P8_5
91	DIGIO_6	P8_6		92	DIGIO_7	P11_0
93	DIGIO_8	P10_0		94	DIGIO_9	P10_7
95	DIGIO_10	P10_8		96	DIGIO_11	P10_15
97	DIGIO_12	P0_9		98	DIGIO_13	P0_10
99	DIGIO_14	P0_11		100	DIGIO_15	P0_12
101	-	-		102	-	-
103	MUX0	P10_4		104	MUX1	P10_5
105	MUX2	P10_6		106	-	-
107	ADC0	AP0_0		108	ADC1	AP0_1
109	ADC2	AP0_2		110	ADC3	AP0_3
111	ADC4	AP0_4		112	ADC5	AP0_5
113	ADC6	AP0_6		114	ADC7	AP0_7
115	-	-		116	-	-
117	VOLTAGE2	-		118	VOLTAGE2	-
119	VOLTAGE2	-		120	VOLTAGE2	-

6.2.2

Connector CN2

Pin	Function	Device Port	Pin	Function	Device Port
1	CAN2Tx	P12_0	2	CAN3Tx	P1_3
3	CAN2Rx	P11_15	4	CAN3Rx	P1_2
5	CAN4Tx	-	6	CAN5Tx	-
7	CAN4Rx	-	8	CAN5Rx	-
9	LIN2Tx	P0_10	10	LIN3Tx	-
11	LIN2Rx	P0_9	12	LIN3Rx	-
13	LIN4Tx	P1_11	14	LIN5Tx	P1_7
15	LIN4Rx	P1_10	16	LIN5Rx	P1_6
17	LIN6Tx	P0_12	18	LIN7Tx	-
Q	LIN6Rx	P0_11	20	LIN7Rx	-
21	LIN8Tx	-	22	LIN9Tx	-
23	LIN8Rx	-	24	LIN9Rx	-
25	LIN10Tx	P10_10	26	LIN11Tx	P0_5
27	LIN10Rx	P10_9	28	LIN11Rx	P0_4
29	LIN12Tx	P0_14	30	LIN13Tx	P1_1
31	LIN12Rx	P0_13	32	LIN13Rx	P1_0
33	LIN14Tx	P1_9	34	LIN15Tx	P1_5
35	LIN14Rx	P1_8	36	LIN15Rx	P1_4
37	-	-	38	-	-
39	-	-	40	-	-
41	MLBCLK	-	42	MLBRESET	-
43	MLBSIG	-	44	MLBDAT	-
45	-	-	46	-	-
47	-	-	48	-	-
49	-	-	50	-	-
51	-	-	52	-	-
53	-	-	54	-	-
55	-	-	56	-	-
57	-	-	58	-	-
59	-	-	60	-	-
61	-	-	62	-	-
63	-	-	64	-	-
65	-	-	66	-	-
67	-	-	68	-	-
69	-	-	70	-	-
71	-	-	72	-	-
73	-	-	74	-	-
75	-	-	76	-	-
77	-	-	78	-	-
79	-	-	80	-	-

81	-	-
83	-	-
85	-	-
87	-	-
89	-	-
91	-	-
93	-	-
95	-	-
97	-	-
99	-	-
101	-	-
103	-	-
105	-	-
107	-	-
109	-	-
111	-	-
113	-	-
115	-	-
117	-	-
119	-	-

82	-	-
84	-	-
86	-	-
88	-	-
90	-	-
92	-	-
94	-	-
96	-	-
98	-	-
100	-	-
102	-	-
104	-	-
106	-	-
108	-	-
110	-	-
112	-	-
114	-	-
116	-	-
118	-	-
120	-	-

6.2.3 Connector CN3

Pin	Function	Device Port	Pin	Function	Device Port
1	PWM00	P10_0	2	PWM01	P10_1
3	PWM02	P10_2	4	PWM03	P10_3
5	PWM04	P10_7	6	PWM05	P10_8
7	PWM06	P10_9	8	PWM07	P10_10
9	PWM08	P9_0	10	PWM09	P9_1
11	PWM10	P0_4	12	PWM11	P0_1
13	PWM12	P0_2	14	PWM13	P0_3
15	PWM14	P8_0	16	PWM15	P8_1
17	PWM16	P10_11	18	PWM17	P10_12
Q	PWM18	P10_13	20	PWM19	P10_14
21	PWM20	P9_2	22	PWM21	P9_3
23	PWM22	P8_2	24	PWM23	P8_3
25	PWM24	P10_15	26	PWM25	P11_0
27	PWM26	P11_1	28	PWM27	P11_2
29	PWM28	P11_3	30	PWM29	P11_4
31	PWM30	P11_5	32	PWM31	P11_6
33	PWM32	P11_7	34	PWM33	P9_4
35	PWM34	P9_5	36	PWM35	P9_6

37	PWM36	P8_4
39	PWM38	P8_6
41	PWM40	P8_8
43	PWM42	P8_10
45	PWM44	P8_12
47	PWM46	P0_13
49	PWM48	P11_8
51	PWM50	P11_10
53	PWM52	P11_12
55	PWM54	P11_14
57	PWM56	P12_0
59	PWM58	P12_2
61	PWM60	P20_5
63	PWM62	P18_1
65	PWM64	-
67	PWM66	-
69	PWM68	-
71	PWM70	-
73	PWM72	-
75	PWM74	-
77	PWM76	-
79	PWM78	-
81	PWMADC00	AP0_8
83	PWMADC02	AP0_10
85	PWMADC04	AP0_12
87	PWMADC06	AP0_14
89	PWMADC08	AP1_0
91	PWMADC10	AP1_2
93	PWMADC12	AP1_4
95	PWMADC14	AP1_6
97	-	-
99	-	-
101	-	-
103	-	-
105	-	-
107	-	-
109	-	-
111	-	-
113	-	-
115	-	-
117	-	-
119	-	-

38	PWM37	P8_5
40	PWM39	P8_7
42	PWM41	P8_9
44	PWM43	P8_11
46	PWM45	P0_12
48	PWM47	P0_14
50	PWM49	P11_9
52	PWM51	P11_11
54	PWM53	P11_13
56	PWM55	P11_15
58	PWM57	P12_1
60	PWM59	P20_4
62	PWM61	P18_0
64	PWM63	P18_2
66	PWM65	-
68	PWM67	-
70	PWM69	-
72	PWM71	P18_3
74	PWM73	-
76	PWM75	-
78	PWM77	-
80	PWM79	-
82	PWMADC01	AP0_9
84	PWMADC03	AP0_11
86	PWMADC05	AP0_13
88	PWMADC07	AP0_15
90	PWMADC09	AP1_1
92	PWMADC11	AP1_3
94	PWMADC13	AP1_5
96	PWMADC15	AP1_7
98	-	-
100	-	-
102	-	-
104	-	-
106	-	-
108	-	-
110	-	-
112	-	-
114	-	-
116	-	-
118	-	-
120	-	-

Chapter 7 Precautions

7.1 CAN1 signals for R1L

When using this PiggyBoard in conjunction of R1L 100-pin device and the RH850-X1X-MB-T1-Vx mainboard the following details must be noted:

On the PiggyBoard the signals of P0_2 and P0_3 are connected the CN1 pins 30 and 28 for usage as CAN1Rx and CAN1Tx signals.

The ports P0_2 and P0_3 on the R1L 100-pin device do not carry those CAN1 signals, they are available (only) at ports P10_6 (CAN1RX) and P10_7 (CAN1TX).

In order to use the CAN1 instance of the R1L device on the MainBoard a manual wire connection must be made between the related pins of the device and pin headers on the MainBoard. See the connection below for details:

CAN1 signals	PiggyBoard	MainBoard
CAN1Tx	Pin 121 (P10_7)	CN5 pin 1
CAN1Rx	Pin 120 (P10_6)	CN5 pin 2

Chapter 8 Mechanical dimensions

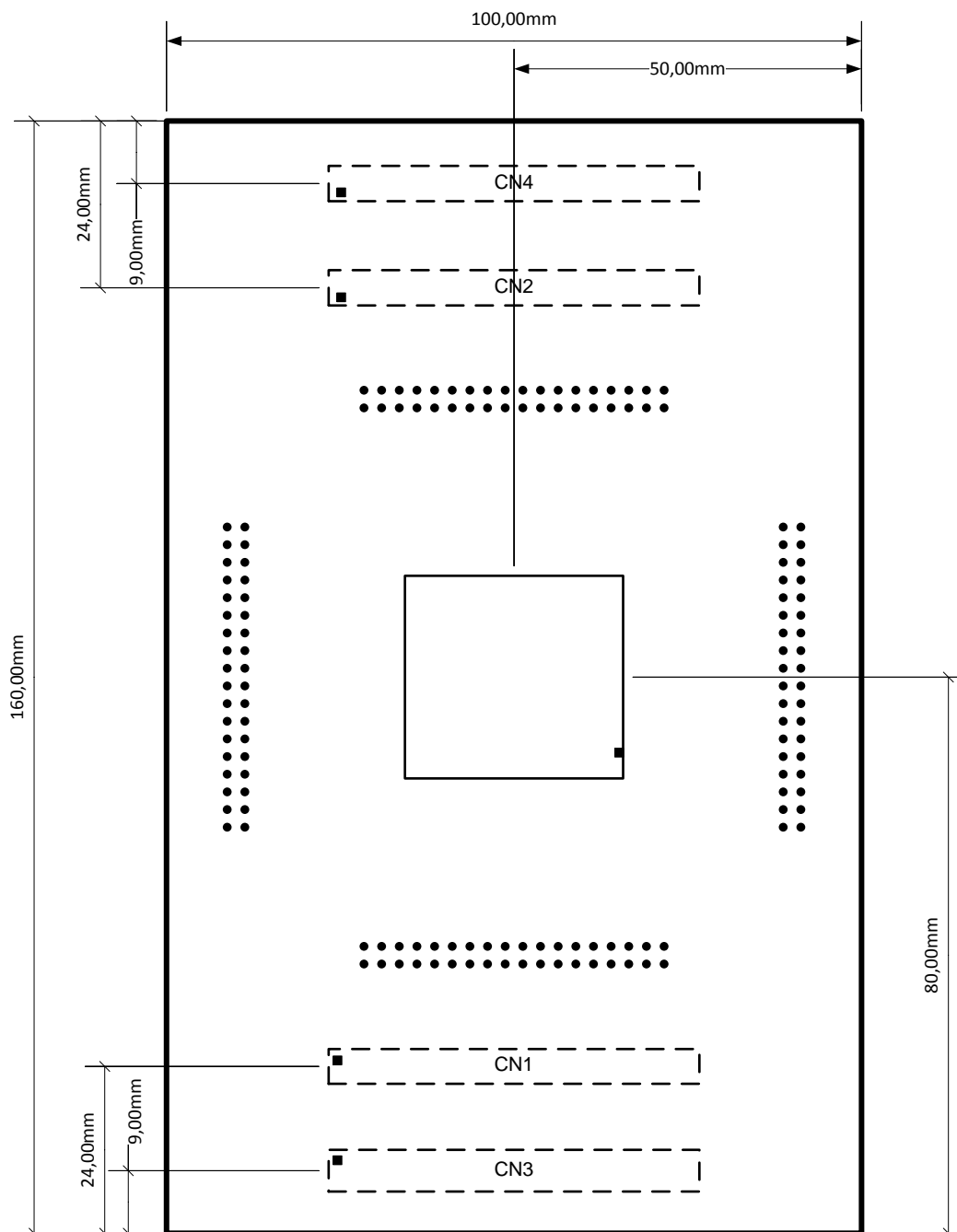

Chapter 9 Schematic

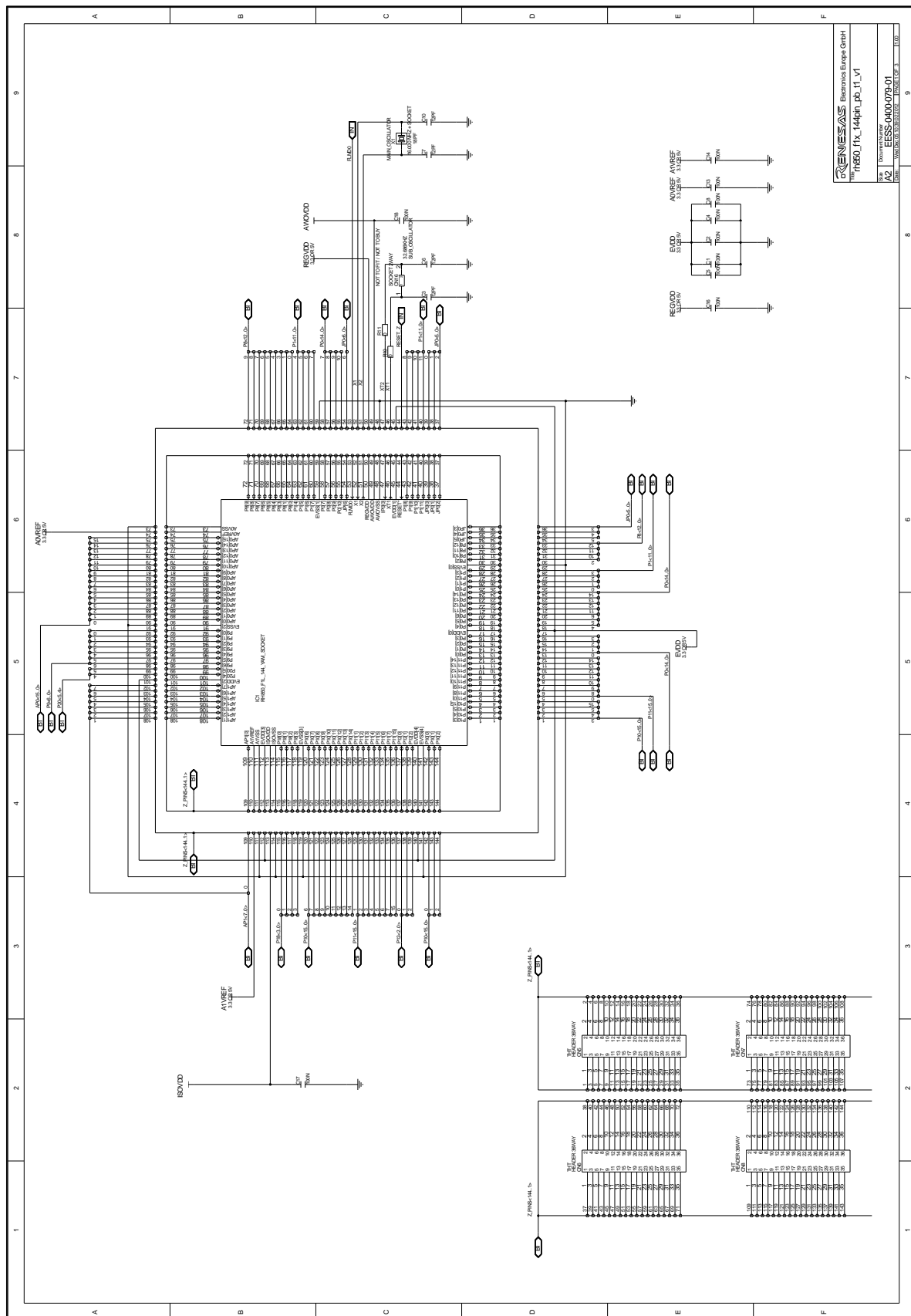

RENESAS Electronics Europe GmbH
 R8B0J1X_144Pin_DP11_V1
 A2
 E8SS-0400-079-01
 100%
 2014/06/10 10:02:02 100% 100%

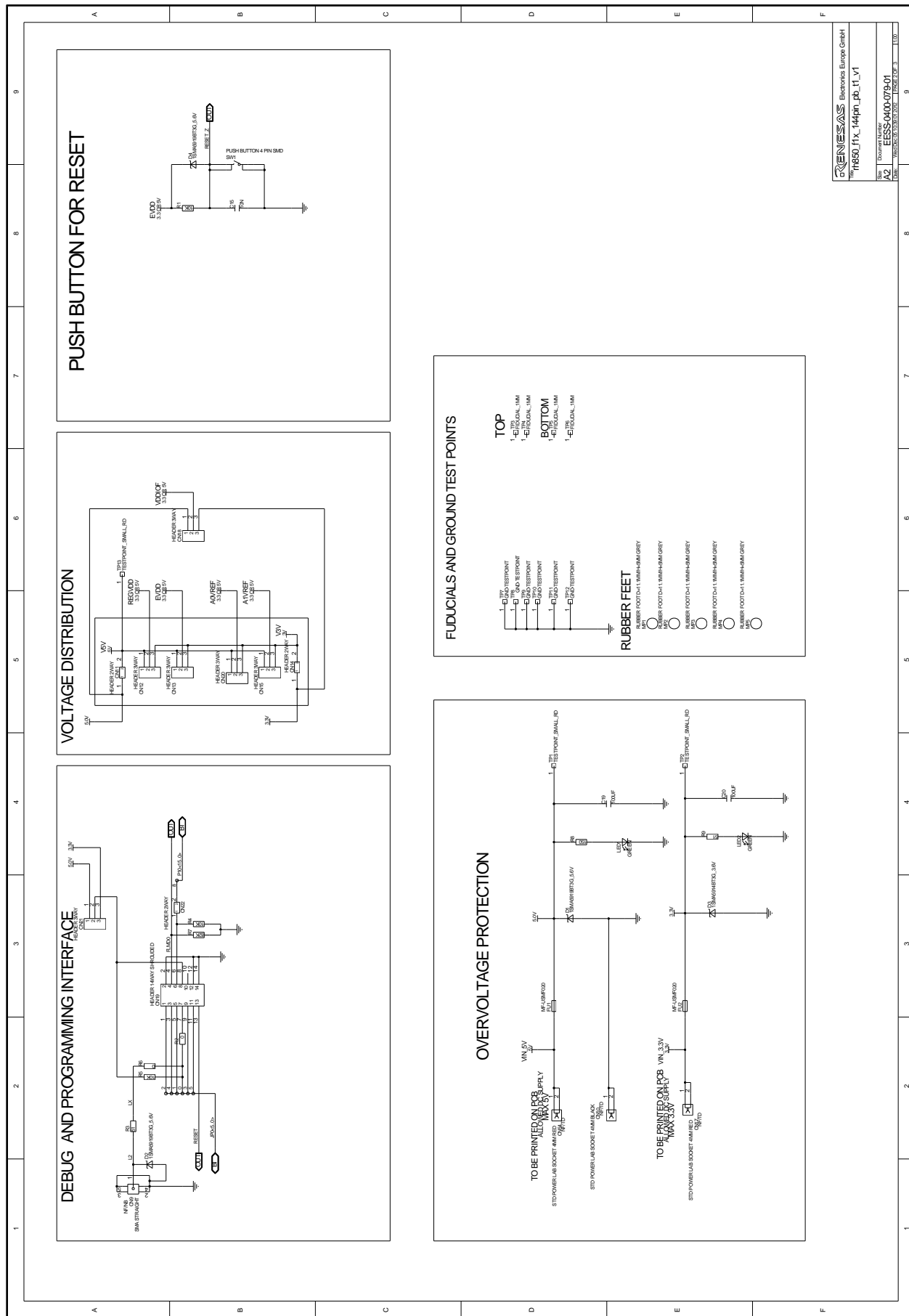

RENESAS Electronics Europe GmbH
r860_11x_144pin_pb_11_v1
Doc ID: 650344
ESS040-075-01
REV. 02/2013

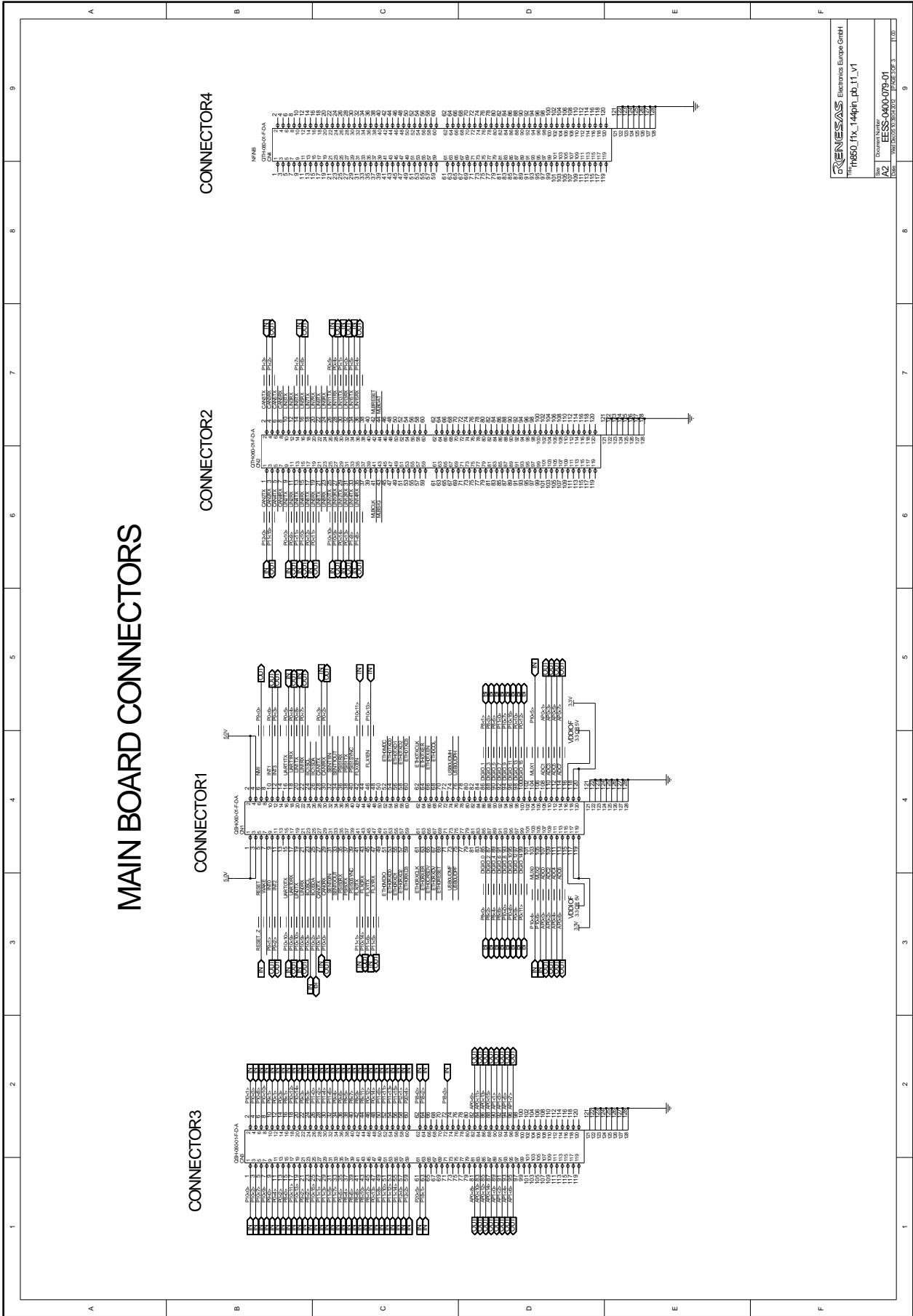

Chapter 10 Revision History

The table provides information about the major changes of the document versions.

Date	Version	Description
2013-02-18	1.0	Initial release
2014-06-10	1.1	<ul style="list-style-type: none">• Updated description of CN22 usage in chapter 5.• Added chapter 7.1 <i>Precautions for CAN1 signals for R1L</i>

Notice

1. All information included in this document is current as of the date this document is issued. Such information, however, is subject to change without any prior notice. Before purchasing or using any Renesas Electronics products listed herein, please confirm the latest product information with a Renesas Electronics sales office. Also, please pay regular and careful attention to additional and different information to be disclosed by Renesas Electronics such as that disclosed through our website.
2. Renesas Electronics does not assume any liability for infringement of patents, copyrights, or other intellectual property rights of third parties by or arising from the use of Renesas Electronics products or technical information described in this document. No license, express, implied or otherwise, is granted hereby under any patents, copyrights or other intellectual property rights of Renesas Electronics or others.
3. You should not alter, modify, copy, or otherwise misappropriate any Renesas Electronics product, whether in whole or in part.
4. Descriptions of circuits, software and other related information in this document are provided only to illustrate the operation of semiconductor products and application examples. You are fully responsible for the incorporation of these circuits, software, and information in the design of your equipment. Renesas Electronics assumes no responsibility for any losses incurred by you or third parties arising from the use of these circuits, software, or information.
5. When exporting the products or technology described in this document, you should comply with the applicable export control laws and regulations and follow the procedures required by such laws and regulations. You should not use Renesas Electronics products or the technology described in this document for any purpose relating to military applications or use by the military, including but not limited to the development of weapons of mass destruction. Renesas Electronics products and technology may not be used for or incorporated into any products or systems whose manufacture, use, or sale is prohibited under any applicable domestic or foreign laws or regulations.
6. Renesas Electronics has used reasonable care in preparing the information included in this document, but Renesas Electronics does not warrant that such information is error free. Renesas Electronics assumes no liability whatsoever for any damages incurred by you resulting from errors in or omissions from the information included herein.
7. Renesas Electronics products are classified according to the following three quality grades: "Standard", "High Quality", and "Specific". The recommended applications for each Renesas Electronics product depends on the product's quality grade, as indicated below. You must check the quality grade of each Renesas Electronics product before using it in a particular application. You may not use any Renesas Electronics product for any application categorized as "Specific" without the prior written consent of Renesas Electronics. Further, you may not use any Renesas Electronics product for any application for which it is not intended without the prior written consent of Renesas Electronics. Renesas Electronics shall not be in any way liable for any damages or losses incurred by you or third parties arising from the use of any Renesas Electronics product for an application categorized as "Specific" or for which the product is not intended where you have failed to obtain the prior written consent of Renesas Electronics.

The quality grade of each Renesas Electronics product is "Standard" unless otherwise expressly specified in a Renesas Electronics data sheets or data books, etc.

"Standard": Computers; office equipment; communications equipment; test and measurement equipment; audio and visual equipment; home electronic appliances; machine tools; personal electronic equipment; and industrial robots.

"High Quality": Transportation equipment (automobiles, trains, ships, etc.); traffic control systems; anti-disaster systems; anti-crime systems; safety equipment; and medical equipment not specifically designed for life support.

"Specific": Aircraft; aerospace equipment; submersible repeaters; nuclear reactor control systems; medical equipment or systems for life support (e.g. artificial life support devices or systems), surgical implantations, or healthcare intervention (e.g. excision, etc.), and any other applications or purposes that pose a direct threat to human life.

8. You should use the Renesas Electronics products described in this document within the range specified by Renesas Electronics, especially with respect to the maximum rating, operating supply voltage range, movement power voltage range, heat radiation characteristics, installation and other product characteristics. Renesas Electronics shall have no liability for malfunctions or damages arising out of the use of Renesas Electronics products beyond such specified ranges.

-
9. Although Renesas Electronics endeavors to improve the quality and reliability of its products, semiconductor products have specific characteristics such as the occurrence of failure at a certain rate and malfunctions under certain use conditions. Further, Renesas Electronics products are not subject to radiation resistance design. Please be sure to implement safety measures to guard them against the possibility of physical injury, and injury or damage caused by fire in the event of the failure of a Renesas Electronics product, such as safety design for hardware and software including but not limited to redundancy, fire control and malfunction prevention, appropriate treatment for aging degradation or any other appropriate measures. Because the evaluation of microcomputer software alone is very difficult, please evaluate the safety of the final products or system manufactured by you.
 10. Please contact a Renesas Electronics sales office for details as to environmental matters such as the environmental compatibility of each Renesas Electronics product. Please use Renesas Electronics products in compliance with all applicable laws and regulations that regulate the inclusion or use of controlled substances, including without limitation, the EU RoHS Directive. Renesas Electronics assumes no liability for damages or losses occurring as a result of your noncompliance with applicable laws and regulations.
 11. This document may not be reproduced or duplicated, in any form, in whole or in part, without prior written consent of Renesas Electronics.
 12. Please contact a Renesas Electronics sales office if you have any questions regarding the information contained in this document or Renesas Electronics products, or if you have any other inquiries.

(Note 1) "Renesas Electronics" as used in this document means Renesas Electronics Corporation and also includes its majority-owned subsidiaries.

(Note 2) "Renesas Electronics product(s)" means any product developed or manufactured by or for Renesas Electronics.



Renesas Electronics Corporation
www.renesas.com