

# RX72N Group

Renesas Starter Kit+ for RX72N  
User's Manual

RENESAS 32-Bit MCU  
RX Family / RX700 Series

All information contained in these materials, including products and product specifications, represents information on the product at the time of publication and is subject to change by Renesas Electronics Corp. without notice. Please review the latest information published by Renesas Electronics Corp. through various means, including the Renesas Electronics Corp. website (<http://www.renesas.com>).

## Notice

1. Descriptions of circuits, software and other related information in this document are provided only to illustrate the operation of semiconductor products and application examples. You are fully responsible for the incorporation or any other use of the circuits, software, and information in the design of your product or system. Renesas Electronics disclaims any and all liability for any losses and damages incurred by you or third parties arising from the use of these circuits, software, or information.
2. Renesas Electronics hereby expressly disclaims any warranties against and liability for infringement or any other claims involving patents, copyrights, or other intellectual property rights of third parties, by or arising from the use of Renesas Electronics products or technical information described in this document, including but not limited to, the product data, drawings, charts, programs, algorithms, and application examples.
3. No license, express, implied or otherwise, is granted hereby under any patents, copyrights or other intellectual property rights of Renesas Electronics or others.
4. You shall not alter, modify, copy, or reverse engineer any Renesas Electronics product, whether in whole or in part. Renesas Electronics disclaims any and all liability for any losses or damages incurred by you or third parties arising from such alteration, modification, copying or reverse engineering.
5. Renesas Electronics products are classified according to the following two quality grades: "Standard" and "High Quality". The intended applications for each Renesas Electronics product depends on the product's quality grade, as indicated below.

"Standard": Computers; office equipment; communications equipment; test and measurement equipment; audio and visual equipment; home electronic appliances; machine tools; personal electronic equipment; industrial robots; etc.

"High Quality": Transportation equipment (automobiles, trains, ships, etc.); traffic control (traffic lights); large-scale communication equipment; key financial terminal systems; safety control equipment; etc.

Unless expressly designated as a high reliability product or a product for harsh environments in a Renesas Electronics data sheet or other Renesas Electronics document, Renesas Electronics products are not intended or authorized for use in products or systems that may pose a direct threat to human life or bodily injury (artificial life support devices or systems; surgical implantations; etc.), or may cause serious property damage (space system; undersea repeaters; nuclear power control systems; aircraft control systems; key plant systems; military equipment; etc.). Renesas Electronics disclaims any and all liability for any damages or losses incurred by you or any third parties arising from the use of any Renesas Electronics product that is inconsistent with any Renesas Electronics data sheet, user's manual or other Renesas Electronics document.

6. When using Renesas Electronics products, refer to the latest product information (data sheets, user's manuals, application notes, "General Notes for Handling and Using Semiconductor Devices" in the reliability handbook, etc.), and ensure that usage conditions are within the ranges specified by Renesas Electronics with respect to maximum ratings, operating power supply voltage range, heat dissipation characteristics, installation, etc. Renesas Electronics disclaims any and all liability for any malfunctions, failure or accident arising out of the use of Renesas Electronics products outside of such specified ranges.
7. Although Renesas Electronics endeavors to improve the quality and reliability of Renesas Electronics products, semiconductor products have specific characteristics, such as the occurrence of failure at a certain rate and malfunctions under certain use conditions. Unless designated as a high reliability product or a product for harsh environments in a Renesas Electronics data sheet or other Renesas Electronics document, Renesas Electronics products are not subject to radiation resistance design. You are responsible for implementing safety measures to guard against the possibility of bodily injury, injury or damage caused by fire, and/or danger to the public in the event of a failure or malfunction of Renesas Electronics products, such as safety design for hardware and software, including but not limited to redundancy, fire control and malfunction prevention, appropriate treatment for aging degradation or any other appropriate measures. Because the evaluation of microcomputer software alone is very difficult and impractical, you are responsible for evaluating the safety of the final products or systems manufactured by you.
8. Please contact a Renesas Electronics sales office for details as to environmental matters such as the environmental compatibility of each Renesas Electronics product. You are responsible for carefully and sufficiently investigating applicable laws and regulations that regulate the inclusion or use of controlled substances, including without limitation, the EU RoHS Directive, and using Renesas Electronics products in compliance with all these applicable laws and regulations. Renesas Electronics disclaims any and all liability for damages or losses occurring as a result of your noncompliance with applicable laws and regulations.
9. Renesas Electronics products and technologies shall not be used for or incorporated into any products or systems whose manufacture, use, or sale is prohibited under any applicable domestic or foreign laws or regulations. You shall comply with any applicable export control laws and regulations promulgated and administered by the governments of any countries asserting jurisdiction over the parties or transactions.
10. It is the responsibility of the buyer or distributor of Renesas Electronics products, or any other party who distributes, disposes of, or otherwise sells or transfers the product to a third party, to notify such third party in advance of the contents and conditions set forth in this document.
11. This document shall not be reprinted, reproduced or duplicated in any form, in whole or in part, without prior written consent of Renesas Electronics.
12. Please contact a Renesas Electronics sales office if you have any questions regarding the information contained in this document or Renesas Electronics products.

(Note1) "Renesas Electronics" as used in this document means Renesas Electronics Corporation and also includes its directly or indirectly controlled subsidiaries.

(Note2) "Renesas Electronics product(s)" means any product developed or manufactured by or for Renesas Electronics.

(Rev.4.0-1 November 2017)

## Corporate Headquarters

TOYOSU FORESIA, 3-2-24 Toyosu,  
Koto-ku, Tokyo 135-0061, Japan

[www.renesas.com](http://www.renesas.com)

## Contact information

For further information on a product, technology, the most up-to-date version of a document, or your nearest sales office, please visit:

[www.renesas.com/contact/](http://www.renesas.com/contact/).

## Trademarks

Renesas and the Renesas logo are trademarks of Renesas Electronics Corporation. All trademarks and registered trademarks are the property of their respective owners.

## General Precautions in the Handling of Microprocessing Unit and Microcontroller Unit Products

The following usage notes are applicable to all Microprocessing unit and Microcontroller unit products from Renesas. For detailed usage notes on the products covered by this document, refer to the relevant sections of the document as well as any technical updates that have been issued for the products.

### 1. Precaution against Electrostatic Discharge (ESD)

A strong electrical field, when exposed to a CMOS device, can cause destruction of the gate oxide and ultimately degrade the device operation. Steps must be taken to stop the generation of static electricity as much as possible, and quickly dissipate it when it occurs. Environmental control must be adequate. When it is dry, a humidifier should be used. This is recommended to avoid using insulators that can easily build up static electricity. Semiconductor devices must be stored and transported in an anti-static container, static shielding bag or conductive material. All test and measurement tools including work benches and floors must be grounded. The operator must also be grounded using a wrist strap. Semiconductor devices must not be touched with bare hands. Similar precautions must be taken for printed circuit boards with mounted semiconductor devices.

### 2. Processing at power-on

The state of the product is undefined at the time when power is supplied. The states of internal circuits in the LSI are indeterminate and the states of register settings and pins are undefined at the time when power is supplied. In a finished product where the reset signal is applied to the external reset pin, the states of pins are not guaranteed from the time when power is supplied until the reset process is completed. In a similar way, the states of pins in a product that is reset by an on-chip power-on reset function are not guaranteed from the time when power is supplied until the power reaches the level at which resetting is specified.

### 3. Input of signal during power-off state

Do not input signals or an I/O pull-up power supply while the device is powered off. The current injection that results from input of such a signal or I/O pull-up power supply may cause malfunction and the abnormal current that passes in the device at this time may cause degradation of internal elements. Follow the guideline for input signal during power-off state as described in your product documentation.

### 4. Handling of unused pins

Handle unused pins in accordance with the directions given under handling of unused pins in the manual. The input pins of CMOS products are generally in the high-impedance state. In operation with an unused pin in the open-circuit state, extra electromagnetic noise is induced in the vicinity of the LSI, an associated shoot-through current flows internally, and malfunctions occur due to the false recognition of the pin state as an input signal become possible.

### 5. Clock signals

After applying a reset, only release the reset line after the operating clock signal becomes stable. When switching the clock signal during program execution, wait until the target clock signal is stabilized. When the clock signal is generated with an external resonator or from an external oscillator during a reset, ensure that the reset line is only released after full stabilization of the clock signal. Additionally, when switching to a clock signal produced with an external resonator or by an external oscillator while program execution is in progress, wait until the target clock signal is stable.

### 6. Voltage application waveform at input pin

Waveform distortion due to input noise or a reflected wave may cause malfunction. If the input of the CMOS device stays in the area between  $V_{IL}$  (Max.) and  $V_{IH}$  (Min.) due to noise, for example, the device may malfunction. Take care to prevent chattering noise from entering the device when the input level is fixed, and also in the transition period when the input level passes through the area between  $V_{IL}$  (Max.) and  $V_{IH}$  (Min.).

### 7. Prohibition of access to reserved addresses

Access to reserved addresses is prohibited. The reserved addresses are provided for possible future expansion of functions. Do not access these addresses as the correct operation of the LSI is not guaranteed.

### 8. Differences between products

Before changing from one product to another, for example to a product with a different part number, confirm that the change will not lead to problems. The characteristics of a microprocessing unit or microcontroller unit products in the same group but having a different part number might differ in terms of internal memory capacity, layout pattern, and other factors, which can affect the ranges of electrical characteristics, such as characteristic values, operating margins, immunity to noise, and amount of radiated noise. When changing to a product with a different part number, implement a system-evaluation test for the given product.

## Disclaimer

By using this Renesas Starter Kit+ (RSK+), the user accepts the following terms:

The RSK+ is not guaranteed to be error free, and the entire risk as to the results and performance of the RSK+ is assumed by the User. The RSK+ is provided by Renesas on an "as is" basis without warranty of any kind whether express or implied, including but not limited to the implied warranties of satisfactory quality, fitness for a particular purpose, title and non-infringement of intellectual property rights with regard to the RSK+. Renesas expressly disclaims all such warranties. Renesas or its affiliates shall in no event be liable for any loss of profit, loss of data, loss of contract, loss of business, damage to reputation or goodwill, any economic loss, any reprogramming or recall costs (whether the foregoing losses are direct or indirect) nor shall Renesas or its affiliates be liable for any other direct or indirect special, incidental or consequential damages arising out of or in relation to the use of this RSK+, even if Renesas or its affiliates have been advised of the possibility of such damages.

## Precautions

The following precautions should be observed when operating any RSK+ product:

This Renesas Starter Kit+ is only intended for use in a laboratory environment under ambient temperature and humidity conditions. A safe separation distance should be used between this and any sensitive equipment. Its use outside the laboratory, classroom, study area or similar such area invalidates conformity with the protection requirements of the Electromagnetic Compatibility Directive and could lead to prosecution.

The product generates, uses, and can radiate radio frequency energy and may cause harmful interference to radio communications. However, there is no guarantee that interference will not occur in a particular installation. If this equipment causes harmful interference to radio or television reception, which can be determined by turning the equipment off or on, you are encouraged to try to correct the interference by one or more of the following measures;

- ensure attached cables do not lie across the equipment
- reorient the receiving antenna
- increase the distance between the equipment and the receiver
- connect the equipment into an outlet on a circuit different from that which the receiver is connected
- power down the equipment when not in use
- consult the dealer or an experienced radio/TV technician for help NOTE: It is recommended that wherever possible shielded interface cables are used.

The product is potentially susceptible to certain EMC phenomena. To mitigate against them it is recommended that the following measures be undertaken;

- The user is advised that mobile phones should not be used within 10m of the product when in use.
- The user is advised to take ESD precautions when handling the equipment.

The Renesas Starter Kit does not represent an ideal reference design for an end product and does not fulfil the regulatory standards for an end product.

# How to Use This Manual

## 1. Purpose and Target Readers

This manual is designed to provide the user with an understanding of the CPU Board hardware functionality, and electrical characteristics. It is intended for users designing sample code on the CPU Board platform, using the many different incorporated peripheral devices.

The manual comprises of an overview of the capabilities of the RSK+ product, but does not intend to be a guide to embedded programming or hardware design.

Particular attention should be paid to the precautionary notes when using the manual. These notes occur within the body of the text, at the end of each section, and in the Usage Notes section.

The revision history summarizes the locations of revisions and additions. It does not list all revisions. Refer to the text of the manual for details.

The following documents apply to the RX72N Group. Make sure to refer to the latest versions of these documents. The newest versions of the documents listed may be obtained from the Renesas Electronics Web site.

Document Type	Description	Document Title	Document No.
User's Manual	Describes the technical details of the RSK+ hardware.	Renesas Starter Kit+ for RX72N User's Manual	R20UT4443EG
Tutorial Manual	Provides a guide to setting up RSK+ environment, running sample code and debugging programs.	Renesas Starter Kit+ for RX72N Tutorial Manual	CS+: R20UT4437EG e <sup>2</sup> studio: R20UT4440EG
Quick Start Guide	Provides simple instructions to setup the RSK+ and run the first sample.	Renesas Starter Kit+ for RX72N Quick Start Guide	CS+: R20UT4438EG e <sup>2</sup> studio: R20UT4441EG
Smart Configurator Tutorial	Provides a guide to code generation and importing into the e <sup>2</sup> studio/CS+ IDE.	Renesas Starter Kit+ for RX72N Smart Configurator Tutorial Manual	CS+: R20UT4439EG e <sup>2</sup> studio: R20UT4442EG
Schematics	Full detail circuit schematics of the CPU Board.	Renesas Starter Kit+ for RX72N Schematics	R20UT4435EG
Hardware Manual	Provides technical details of the RX72N microcontroller.	RX72N Group Hardware Manual	R01UH0824EJ

## 2. List of Abbreviations and Acronyms

Abbreviation	Full Form
ADC	Analog-to-Digital Converter
BC	Battery Charging
bps	bits per second
CAN	Controller Area Network
CPU	Central Processing Unit
DAC	Digital-to-Analog Converter
DIP	Dual In-line Package
DMA	Direct Memory Access
DMAC	Direct Memory Access Controller
DNF	Do Not Fit
E1 / E2 Lite	Renesas On-chip Debugging Emulator
EEPROM	Electrically Erasable Programmable Read Only Memory
EMC	Electromagnetic Compatibility
ESD	Electrostatic Discharge
GLCDC	Graphic LCD Controller
I2C (IIC)	Philips™ Inter-Integrated Circuit Connection Bus
IRQ	Interrupt Request
LCD	Liquid Crystal Display
LED	Light Emitting Diode
LIN	Local Interconnect Network
MCU	Micro-controller Unit
MII	Media Independent Interface
MTU	Multi-Function Timer Pulse Unit
n/a (NA)	Not Applicable
n/c (NC)	Not Connected
NMI	Non-maskable Interrupt
OTG	On The Go™
PC	Personal Computer
PDC	Parallel Data Capture Unit
PLL	Phase Locked Loop
Pmod™	This is a Digilent Pmod™ Compatible connector. Pmod™ is registered to Digilent Inc. <a href="#">Digilent-Pmod Interface Specification</a>
POE	Port Output Enable
PWM	Pulse Width Modulation
RAM	Random Access Memory
RMII	Reduced Media Independent Interface
ROM	Read Only Memory
RSK+	Renesas Starter Kit+
RTC	Real Time Clock
SCI	Serial Communications Interface
SPI	Serial Peripheral Interface
SSI	Serial Sound Interface
TFT	Thin Film Transistor
UART	Universal Asynchronous Receiver/Transmitter
USB	Universal Serial Bus
WDT	Watchdog Timer

All trademarks and registered trademarks are the property of their respective owners.

## Table of Contents

1. Overview.....	9
1.1 Purpose.....	9
1.2 Features.....	9
1.3 Board specification.....	10
2. Power Supply .....	11
2.1 Requirements.....	11
2.2 Power-Up Behaviour.....	11
3. Board Layout .....	12
3.1 Component Layout.....	12
3.2 Board Dimensions.....	13
3.3 Component Placement .....	14
4. Connectivity .....	16
4.1 Internal Board Connections .....	16
4.2 Debugger Connections .....	17
5. User Circuitry .....	18
5.1 Reset Circuit .....	18
5.2 Clock Circuit.....	18
5.3 Switches.....	18
5.4 LEDs .....	19
5.5 Potentiometer.....	19
5.6 Pmod™ .....	20
5.7 USB Serial Port.....	21
5.8 Controller Area Network (CAN).....	21
5.9 Ethernet.....	22
5.10 Universal Serial Bus (USB).....	23
5.11 External Bus.....	23
5.12 SDRAM .....	24
5.13 Renesas Serial Peripheral Interface (RSPI) .....	25
5.14 Quad Serial Peripheral Interface (QSPI) .....	25
5.15 I <sup>2</sup> C Bus (Inter-IC Bus) .....	25
5.16 SD Host Interface (SDHI).....	26
5.17 Parallel Data Capture Unit Interface (PDC).....	26
5.18 Serial Sound Interface Enhanced (SSIE) .....	26
5.19 Graphic LCD Controller (GLCDC) .....	27
5.20 Unused terminal.....	28
6. Configuration .....	29
6.1 Modifying the RSK+ .....	29
6.2 MCU Operating Modes .....	29
6.3 E1/E2 Lite Debugger Configuration .....	30
6.4 Power Supply Configuration .....	31
6.5 Clock Configuration.....	31
6.6 Analog Power, ADC and DAC Configuration .....	32
6.7 BUS & SDRAM Configuration.....	33
6.8 CAN Configuration .....	35
6.9 Ethernet Configuration .....	36
6.10 General IO & LED Configuration .....	37
6.11 GLCDC Configuration .....	37
6.12 I <sup>2</sup> C & EEPROM Configuration .....	39
6.13 IRQ & Switch Configuration .....	39
6.14 MTU & POE Configuration.....	40
6.15 PDC Configuration .....	41
6.16 PMOD1 Configuration.....	43

6.17	PMOD2 Configuration .....	43
6.18	QSPI Configuration .....	44
6.19	RSPI Configuration .....	44
6.20	SDHI Configuration .....	44
6.21	Serial & USB to Serial Configuration .....	45
6.22	SSIE Configuration .....	46
6.23	USB Configuration .....	46
6.24	Unused Terminal Configuration .....	47
<b>7.</b>	<b>Headers .....</b>	<b>48</b>
7.1	Application Headers .....	48
<b>8.</b>	<b>Code Development .....</b>	<b>53</b>
8.1	Overview .....	53
8.2	Compiler Restrictions .....	53
8.3	Mode Support .....	53
8.4	Debugging Support .....	53
8.5	Address Space .....	53
8.6	Note of Flash Access Window Setting Register .....	53
<b>9.</b>	<b>Additional Information .....</b>	<b>54</b>



---

# Renesas Starter Kit+ for RX72N

## User's Manual

---

## 1. Overview

### 1.1 Purpose

This CPU Board is an evaluation tool for Renesas microcontrollers. This manual describes the technical details of the CPU Board hardware.

### 1.2 Features

This RSK+ provides an evaluation of the following features:

- Renesas microcontroller programming
- User code debugging
- User circuitry such as switches, LEDs and a potentiometer
- Sample applications
- Sample peripheral device initialisation code

The RSK+ board contains all the circuitry required for microcontroller operation.

### 1.3 Board specification

Board specification was shown in **Table 1-1** below.

**Table 1-1: Board Specification**

Item	Specification
Microcontroller	Part No : R5F572NNDDDB or R5F572NNHDBD <sup>*3</sup>
	Package : 224-pin LFBGA
	On-Chip Memory : ROM 4MB, RAM 1MB
On-Board Memory	SDRAM: 128Mbit (Data width 16bit)
	I <sup>2</sup> C EEPROM: 2Kbit
	SPI Serial Flash: 32Mbit x 2
Input Clock	RX72N Main : 24MHz
	RX72N Sub : 32.768kHz
	RL78/G1C Main: 12MHz
	Ethernet PHY (for RMII) : 50MHz
Power Supply	DC Power Jack : 5 V Input
	Power Supply IC : 5V Input, 3.3V Output
	Power Supply IC : 5V Input, Max.38V Output(For TFT Backlight)
	Power Supply IC : 3.3V Input, 3.3V Output(For SDHI)
	Power Supply IC : 5V Input, 5V Output(For USB Host)
Debug Interface	E1/E2 Lite 14-pin box header
DIP Switch	Mode Configuration : 2-pole x 1
Push Switch	Reset Switch x 1
	User Switch x 3
Potentiometer(for ADC)	Single-turn, 10kΩ
LED	5V Power indicator: green x 1
	3.3V Power Indicator : green x 1
	User : green x 1, orange x 1, red x 2
	Ethernet Status: green x 1, yellow x 1
Ethernet	Connector : RJ45 x 1
	PHY : Single Channel PHY x 1
SDHI <sup>*1</sup>	SD Card Slot (4-bit) x 1
CAN	Connector : 2.54mm pitch, 3-pin x 1
	CAN Driver : R2A25416SP <sup>*4</sup> x 1
USB	USB0-Function : USB-MiniB
	USB0-Host : USB-TypeA
USB to Serial Converter Interface	Connector : USB-MiniB
	Driver : RL78/G1C Microcontroller (Part No R5F10JBCANA)
Pmod™	PMOD1 : Angle type, 12-pin Connector
	PMOD2 <sup>*2</sup> : Straight type, 12-pin Connector
GLCDC Interface (Mounts On-Board TFT Panel)	FPC Connector : 40-pin x 1 (ONTFT1)
	FPC Connector : 6-pin x 1 (ONTFT2)
PDC Interface <sup>*2</sup>	2.54 mm pitch, 20-pin x 1 (J19)
SSI Interface <sup>*2</sup>	2.54 mm pitch, 12-pin x 1 (J18)
Application Board Interface <sup>*2</sup>	2.54 mm pitch, 26-pin x 2 (JA1, JA2), 50-pin x 1 (JA3), 24-pin x 2 (JA5, JA6)

<sup>\*1</sup>: The RX72N Group incorporate an SD Host Interface (SDHI) which is compliant with the SD Specifications. When developing host devices that are compliant with the SD Specifications, the user must enter into the SD Host/Ancillary Product License Agreement (SD HALA).

<sup>\*2</sup>: The connector is not included in the product.

<sup>\*3</sup>: R5F572NNDDDB does not have a built-in security function, but R5F572NNHDBD has a built-in security function.

<sup>\*4</sup>: This CAN driver has Non-promotion status, so do not use this CAN driver on your system.

## 2. Power Supply

### 2.1 Requirements

This board has an optional centre-positive supply connector using a 2.0mm barrel power jack (PWR). The main power supply connected to PWR should supply a minimum of 10W to ensure full functionality. When the board is connected to another system then that system should supply power to the board.

This CPU board supports one external voltage input. Details of the external power supply connection are shown in **Table 2-1** and **Table 2-2** below. The default power configuration is shown in **bold, blue text**.

**Table 2-1: PWR connector Requirements**

Connector	Supply voltage
PWR	Input 5VDC (4.75V to 5.25V)

There are RSK+ products which supports the 12V voltage input. Since this board is supporting the 5V voltage input, be careful not to connect the power supply of a high-voltage output accidentally. Moreover, the main power supply connected to PWR should supply a minimum of 10W to ensure full functionality.

**Table 2-2: Main Power Supply Requirements**

J17 <sup>*1</sup> Setting	Supply Source	Board_5V	UC_VCC
<b>Open</b>	<b>PWR connector/JA1-5V/Unregulated_VCC</b>	<b>5V</b>	<b>3.3V</b>
Shorted	VBUS0	5V	3.3V

\*1: The connector is not fitted to the RSK+.

### 2.2 Power-Up Behaviour

When the RSK+ is purchased, the RSK+ board has the 'Release' build of the example tutorial software pre-programmed into the Renesas microcontroller. Please consult the 'Renesas Starter Kit+ Smart Configurator Tutorial Manual' for further information of this example.

### 3. Board Layout

#### 3.1 Component Layout

Figure 3-1 below shows the top component layout of the board.

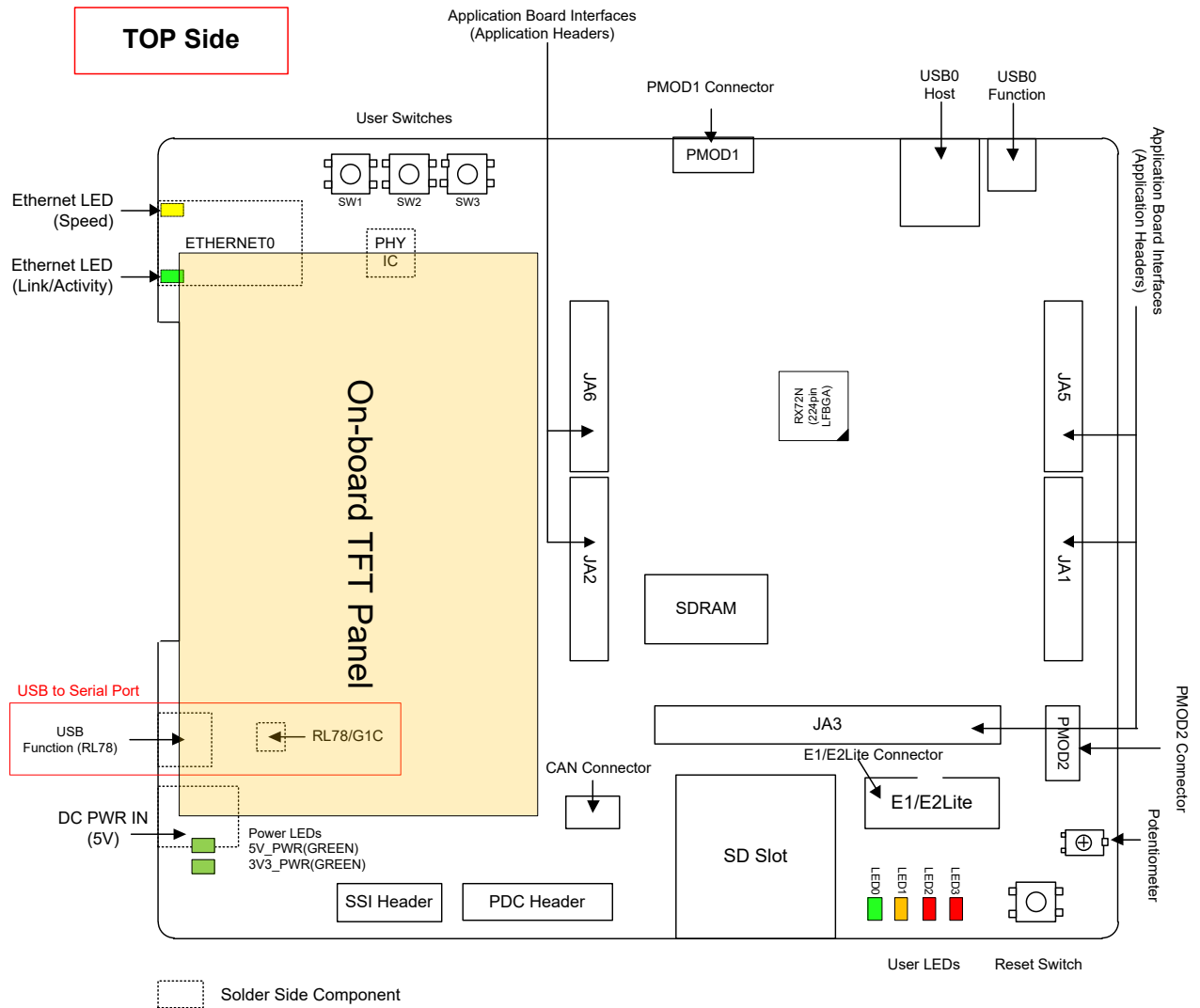

Figure 3-1: Board Layout

### 3.2 Board Dimensions

Figure 3-2 below gives the board dimensions and connector positions. All the through-hole connectors are on a common 2.54mm pitch grid for easy interfacing.

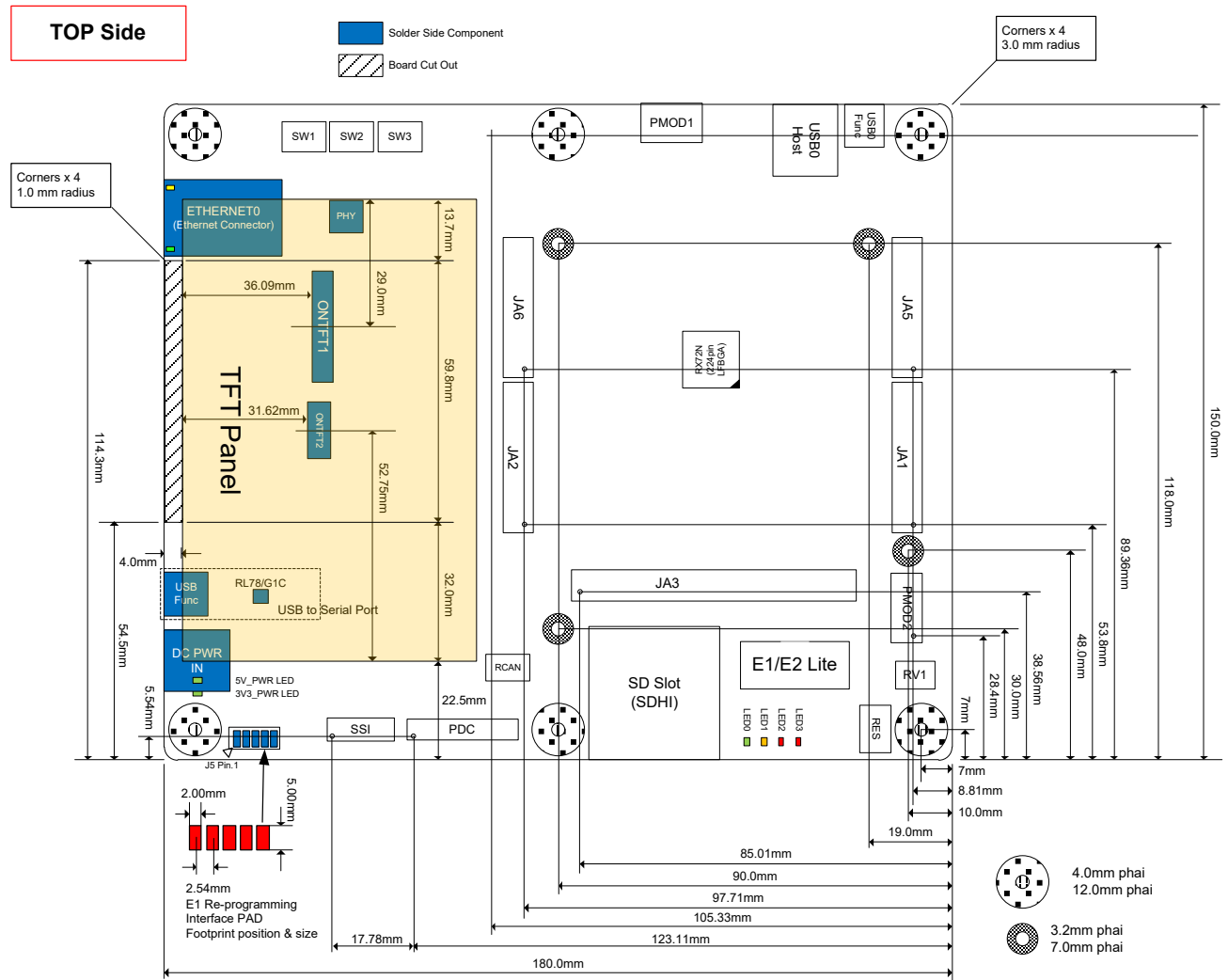

Figure 3-2: Board Dimensions

### 3.3 Component Placement

Figure 3-3 below shows placement of individual components on the top-side PCB – bottom-side component placement can be seen in Figure 3-4. Component types and values are shown on the board schematics.

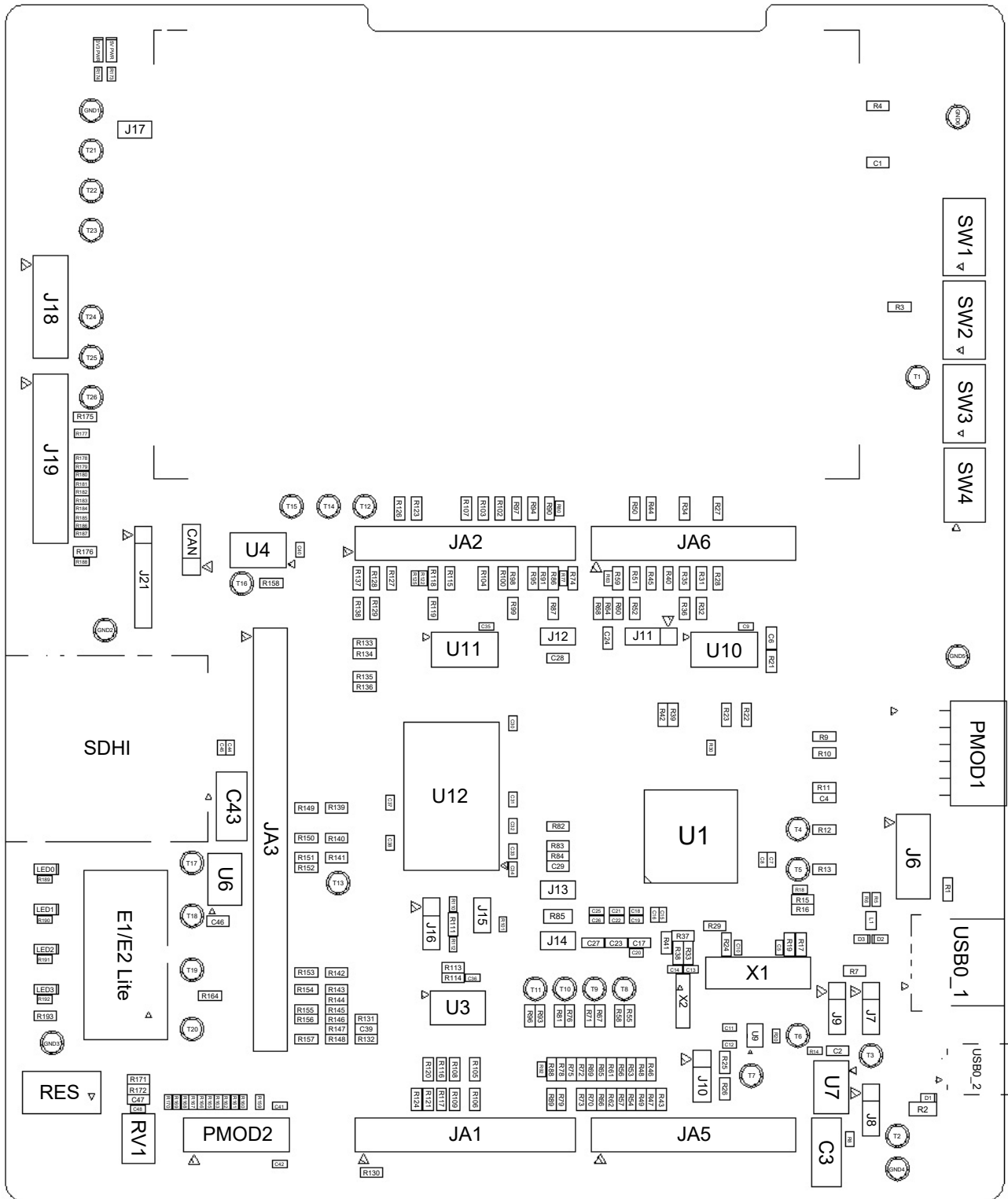

Figure 3-3: Top-Side Component Placement



## 4. Connectivity

### 4.1 Internal Board Connections

The diagram below shows the CPU board components and their connectivity to the MCU.

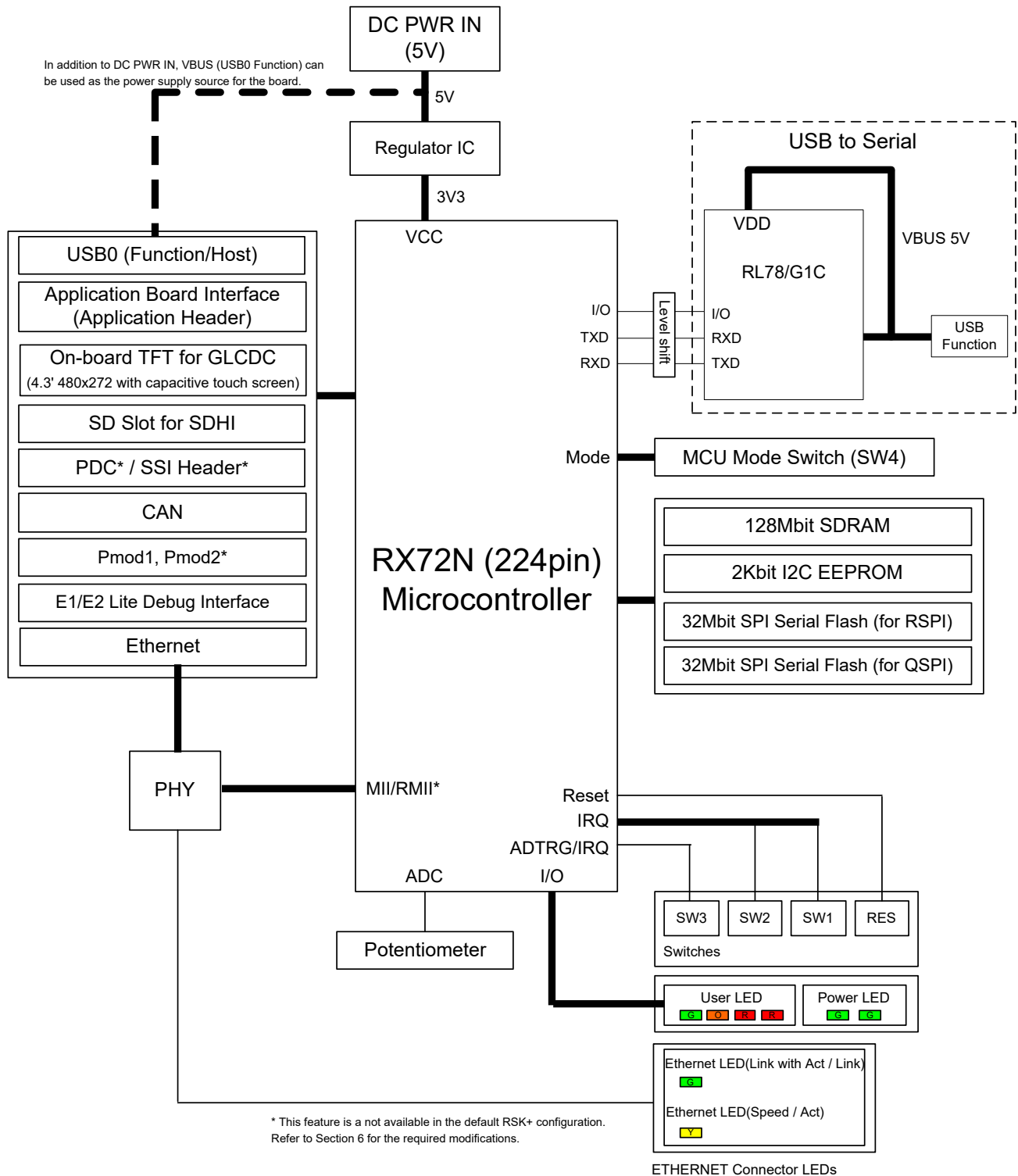

Figure 4-1: Internal Board Block Diagram



## 4.2 Debugger Connections

Figure 4-2 below shows the connections between the CPU board, E1/E2 Lite debugger and the host PC.

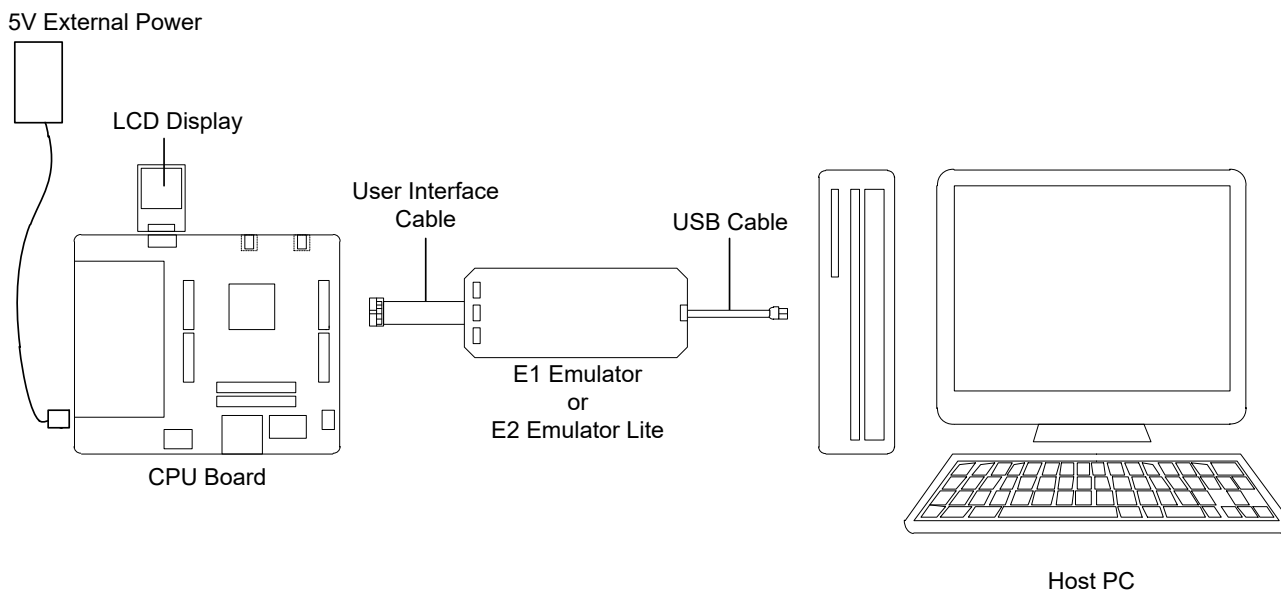

Figure 4-2: Debugger Connection Diagram

## 5. User Circuitry

### 5.1 Reset Circuit

A reset control circuit is fitted to the CPU board to generate the required reset signal, and is triggered from the RES switch. Refer to the RX72N Group User's Manual: Hardware for details regarding the reset signal timing requirements, and the CPU board schematics for information regarding the reset circuitry in use on the board.

### 5.2 Clock Circuit

A clock circuit is fitted to the CPU board to generate the required clock signal to drive the MCU, and associated peripherals. Refer to the RX72N Group Hardware Manual and the RL78/G1C hardware manual for details regarding the clock signal requirements, and the CPU board schematics for information regarding the clock circuitry in use on the CPU board. Details of the oscillators fitted to the board are listed in **Table 5-1** below.

**Table 5-1: Crystal**

Crystal	Function	Default Placement	Frequency	Device Package
X1	Main MCU crystal for RX72N	Fitted	24MHz	Encapsulated, SMT
X2	Real time Clock for RX72N	Fitted	32.768kHz	Encapsulated, SMT
X3	Main MCU crystal for RL78/G1C	Fitted	12MHz	Encapsulated, SMT
X4	Crystal for Ethernet (RMII)	Fitted	50MHz	Encapsulated, SMT

### 5.3 Switches

There are five switches located on the CPU board. The function of each switch and its connection is shown in **Table 5-2** and **Table 5-3**. For further information regarding switch connectivity, refer to the CPU board schematics.

**Table 5-2: Push Switch Connections**

Switch	Function	MCU	
		Signal (Port)	Pin
RES	When pressed, the microcontroller is reset.	RES#	G7
SW1	Connects to an IRQ13-DS input for user controls.	P45	D1
SW2	Connects to an IRQ12-DS input for user controls.	P44	C4
SW3	Connects to an IRQ15 input for user controls. Connects to an ADTRG0 input for ADC controls.	P07	E5

**Table 5-3: DIP Switch Connections**

Switch		Function	MCU	
			Signal (Port)	Pin
SW4	Pin 1	Refer to section 6.2 for the setting contents.	MD/FINED	G4
SW4	Pin 2	Refer to section 6.2 for the setting contents.	PC7	N9

## 5.4 LEDs

There are 8 LEDs on the RSK+ board. The function of each LED, its colour, and its connections are shown in **Table 5-4**.

**Table 5-4: LED Connections**

LED	Colour	Function	MCU	
			Port	Pin
3V3 PWR	Green	Indicates the status of the Board_3V3 power rail.	NC	NC
5V PWR	Green	Indicates the status of the Board_5V power rail.	NC	NC
LED0	Green	User operated LED.	P71	J13
LED1	Orange	User operated LED.	PH6	K2
LED2	Red	User operated LED.	PL7	L10
LED3	Red	User operated LED.	PL6	M12
ETHERNET Connector	Green	Ethernet LED(Link with Activity <sup>*1</sup> / Link)	P93	D7
ETHERNET Connector	Yellow	Ethernet LED(Speed <sup>*1</sup> / Activity)	NC	NC

\*1: Default setting of PHY.

## 5.5 Potentiometer

A single-turn potentiometer is connected as a potential divider to analog input AN000, pin D4. The potentiometer can be used to create a voltage between Board\_3V3 and AVSS0.

Refer to the maker site for specification of the potentiometer (VISHAY with part number TS53 series).

The potentiometer offers an easy method of supplying a variable analog input to the microcontroller. It does not necessarily reflect the accuracy of the controller's ADC. Refer to the RX72N Group User's Manual: Hardware for further details.

### 5.6 Pmod™

The RSK+ board is equipped with connectors for the Digilent Pmod™ interface. Please connect an LCD module that is compatible with the PMOD1 connector.

Care should be taken when installing the LCD module to ensure pins are not bent or damaged. The LCD module is vulnerable to electrostatic discharge (ESD); therefore appropriate ESD protection should be used.

The Digilent Pmod™ Compatible headers use an SPI interface. **Figure 5-1** below shows Digilent Pmod™ Compatible Header Pin Numbering. Connection information for the Digilent Pmod™ Compatible header is provided in **Table 5-5** and **Table 5-6** below.

Please note that the connector numbering adheres to the Digilent Pmod™ standard and is different from all other connectors on the RSK designs. Details can be found in the Digilent Pmod™ Interface Specification Revision: November 20, 2011.

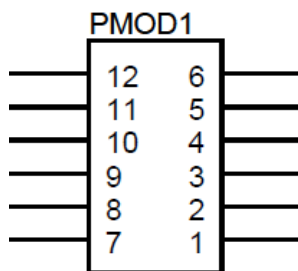

**Figure 5-1: Digilent Pmod™ Compatible Header Pin Numbering**

**Table 5-5: PMOD1 Header Connections**

Digilent Pmod™ Compatible Header Connections							
Pin	Circuit Net Name	MCU		Pin	Circuit Net Name	MCU	
		Port	Pin			Port	Pin
1	PMOD1-CS	PH3	L1	7	PMOD1-IO0	P17	P2
2	PMOD1-MOSI	PH2	J6	8	PMOD1-IO1	P02	D6
3	PMOD1-MISO	PH1	K6	9	PMOD1-IO2	PK7	P1
4	PMOD1-SCK	PH0	N2	10	PMOD1-IO3	PL0	H11
5	GROUND	-	-	11	GROUND	-	-
6	Board_3V3	-	-	12	Board_3V3	-	-

**Table 5-6: PMOD2 Header Connections**

Digilent Pmod™ Compatible Header Connections							
Pin	Circuit Net Name	MCU		Pin	Circuit Net Name	MCU	
		Port	Pin			Port	Pin
1	PMOD2-CS *1	PJ5	G5	7	PMOD2-IO0	P46	B4
2	PMOD2-MOSI *1	P50	K8	8	PMOD2-IO1 *1	P00	E3
3	PMOD2-MISO *1	P52	L8	9	PMOD2-IO2	PQ3	E9
4	PMOD2-SCK *1	P51	M8	10	PMOD2-IO3	P47	D2
5	GROUND	-	-	11	GROUND	-	-
6	Board_3V3	-	-	12	Board_3V3	-	-

\*1: This connection is not available in the default RSK+ configuration - refer to §6 for the required modifications.

### 5.7 USB Serial Port

A USB serial port is implemented in a Renesas low power microcontroller (RL78/G1C) and is connected to the RX72N Serial Communications Interface (SCI) module. Multiple options are provided to allow the selection of the connected SCI9 port. Connections between the USB to Serial converter and the microcontroller are listed in **Table 5-7** below.

**Table 5-7: Serial Port Connections**

Signal Name	Function	MCU	
		Port	Pin
SERIAL-TXD	SCI1 Transmit Signal. *1	PF0	K5
	SCI9 Transmit Signal.	PL2	P12
	External RS232 Transmit Signal. *1	-	-
SERIAL-RXD	SCI1 Receive Signal. *1	PF2	J2
	SCI9 Receive Signal.	PL1	J10
	External RS232 Receive Signal. *1	-	-
SERIAL-CTS *2	Clear To Send.	P03	D3
SERIAL-RTS *2	Request To Send.	P43	E4

\*1: This connection is a not available in the default RSK+ configuration - refer to §6 for the required modifications.

\*2: Flow control is a signal provided for expansion and is not currently supported. There is no schedule of function expansion at present.

When the CPU board is first connected to a PC running Windows™ with the USB/Serial connection, the PC will look for a driver. This driver is installed during the installation process, so the PC should be able to find it. The PC will report that it is installing a driver and then report that a driver has been installed successfully, as shown in **Figure 5-2**. The exact messages may vary depending upon operating system.

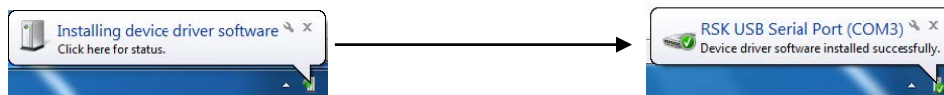

**Figure 5-2: USB-Serial Windows™ Installation message**

If you do not have the driver, please download the driver installer from the following URL.

<https://www.renesas.com/en-eu/software/D6000699.html>

### 5.8 Controller Area Network (CAN)

A CAN transceiver IC is fitted to the RSK+ board, and connected to the CAN MCU peripheral. For further details regarding the CAN protocol and supported modes of operation, please refer to the RX72N Group User’s Manual: Hardware. The connections for the CAN microcontroller signals are listed in **Table 5-8** below.

**Table 5-8: CAN Connections**

CAN Signal	Function	MCU	
		Port	Pin
CAN1TX	CAN Data Transmission.	P32	H5
JA5-CAN1TX *1			
CAN1RX	CAN Data Reception.	P33	H4
JA5-CAN1RX *1			

\*1: This connection is a not available in the default RSK+ configuration - refer to §6 for the required modifications.

## 5.9 Ethernet

When running any Ethernet software, a unique MAC address should be used. A unique Renesas allocated MAC address is attached to the PCB as a sticker, and should be always be used with this device ensured to ensure full compatibility when using other Renesas hardware on a common Ethernet connection.

An Ethernet controller IC is fitted to the CPU board, and is connected to the Ethernet MCU peripheral. The RX72N MCU supports full duplex 10Mb/s and 100Mb/s transmission and reception. Refer to §5.4 for information about the Ethernet LEDs. The connections for the Ethernet controller are listed in **Table 5-9**, **Table 5-10**, **Table 5-11** below.

**Table 5-9: Ethernet Connections**

Ethernet signal	Function	MCU	
		Port	Pin
ET1-TXCLK	MII: Transmit clock	PN2	G9
ET1-TXEN_RMII1TXDEN	MII/RMII: Transmit data valid	PQ7	H8
ET1-ETXD0_RMII1TXD0	MII/RMII: Transmit data 0	PQ5	E10
ET1-ETXD1_RMII1TXD1	MII/RMII: Transmit data 1	PQ6	F9
ET1-ETXD2	MII: Transmit data 2	PN0	E6
ET1-ETXD3	MII: Transmit data 3	PN1	F8
ET1-RXCLK	MII: Receive clock RMII: Reference clock *1	PQ4	E11
ET1-RXER_RMII1RXER	MII/RMII: Receive error	PN3	H9
ET1-ERXD0_RMII1RXD0	MII/RMII: Receive data 0	P94	B7
ET1-ERXD1_RMII1RXD1	MII/RMII: Receive data 1	P95	B8
ET1-ERXD2	MII: Receive data 2	P96	A8
ET1-ERXD3	MII: Receive data 3	P97	C9
ET1-COL	MII: Collision detect signal	P91	B5
ET1-CRS	MII: Carrier sense	PQ0	E7
ET1-LED0	MII/RMII: Link status input from the PHY-LSI	P93	D7
ET1-RXDV_RMII1CRSDV	MII: Receive data valid	P90	C6
	RMII: Carrier sense/receive data valid *1	PQ0	E7

\*1: This connection is a not available in the default RSK+ configuration - refer to §6 for the required modifications.

**Table 5-10: Ethernet Connections**

Ethernet signal	Function	MCU	
		Port	Pin
CLKOUT25M	MII: For PHY clock 25MHz	PH7	K1
ET-MDIO	MII/RMII: Management data I/O	P30	J5
ET-MDC	MII/RMII: Management data clock	P31	J4
SW-PHYRESn *1	MII/RMII: PHY reset controlled by the reset switch on the board	-	-
ET-GPIORST *1	MII/RMII: PHY reset controlled by RX72N port PL4	PL4	R12
ET-INTn	MII/RMII: PHY Interrupt	P15	J7

\*1: In the default RSK+ configuration, both the SW-PHYRESn and ET-GPIORST lines are connected to the reset pin of the Ethernet controller IC. Normally, reset is activated by SW-PHYRESn, so set port PL4 (ET-GPIORST) of the RX72N in the input direction. Refer to §6 for using ET-GPIORST as a reset.

**Table 5-11: Default PHY setting**

Default PHY setting items	Default PHY setting contents
PHY Address	ETHERNET (U13)=1
MII/RMII	MII
Isolate	Disable
Speed	100Mbps
Duplex	Full-Duplex
Auto negotiation	Enable

## 5.10 Universal Serial Bus (USB)

This CPU board is fitted with a USB Host socket (type A) and a Function socket (type Mini B). USB module USB0 is connected to the Host and Function socket, and can operate as either a Host or Function device. The connection for the USB0 module is shown in **Table 5-12** below.

**Table 5-12: USB0 Module Connections**

USB Signal	Function	MCU	
		Port	Pin
USB0-DP	D+ I/O pin of the USB on-chip transceiver	USB0_DP	R6
USB0-DM	D- I/O pin of the USB on-chip transceiver	USB0_DM	R5
USB0-VBUS	USB cable connection monitor pin	P16	R3
USB0-VBUSEN *1	VBUS (5V) supply enable signal for external power supply chip		
USB0-OVRCURA *1	External overcurrent detection signals A	P14	P4
USB0-OVRCURB	External overcurrent detection signals B	P22	N1

\*1: This connection is a not available in the default RSK+ configuration - refer to §6 for the required modifications.

## 5.11 External Bus

The RX72N features an external data bus, which is connected to various devices on the CPU board. Details of the devices connected to the external data bus are listed in **Table 5-13** below. Further details of the devices connected to the external bus can be found in the board schematics.

**Table 5-13: External Bus Address Space**

Chip Select	Device Name	Device Description	Address Space
CS0	-	Unused	FF000000h – FFFFFFFFh (16Mbyte)
SDCS(SDRAM-SDCSn)	U12	128Mbit SDRAM	08000000h – 0FFFFFFFh (128Mbyte)
SDCS(JA3-CSb) *1	JA3	Application Header	08000000h – 0FFFFFFFh (128Mbyte)
CS1 – CS2	-	Unused	06000000h – 07FFFFFFh (2 x 16Mbyte)
CS3(JA3-CSa)	JA3	Application Header	05000000h – 05FFFFFFh (16Mbyte)
CS4 – CS5	-	Unused	03000000h – 04FFFFFFh (2 x 16Mbyte)
CS6(JA3-CSc)	JA3	Application Header	02000000h – 02FFFFFFh (16Mbyte)
CS7	-	Unused	01000000h – 01FFFFFFh (16Mbyte)

\*1: This connection is a not available in the default RSK+ configuration - refer to §6 for the required modifications.

## 5.12 SDRAM

The RX72N features an SDRAM controller. It is connected to SDRAM on the CPU board with a 16-bit width. **Table 5-14** gives an Overview of the onboard SDRAM.

**Table 5-14: Overview of the onboard SDRAM**

Specification	Contents
Type name	MT48LC8M16A2P-6A
Constitution	2Meg x 16 x 4 bank
Capacity	128Mbit
Row address	12bit
Column address	9bit
Number of banks	4
Auto refresh period (tRFC)	Min. 60ns
Initialization auto refresh count	2
Precharge command period (tRP)	Min. 18ns
Auto refresh request interval	15.625us (64ms/4096)
CAS latency (CL)	2 @SDCLK:80MHz
Write recovery period (tWR)	Min. 12ns
ACTIVE-to-PRECHARGE command period (tRAS)	42ns - 12000ns
ACTIVE-to-READ or WRITE delay (tRCD)	Min. 18ns

When accessing SDRAM on the CPU board, make the following settings regardless of the operating frequency of the SDRAM clock. **Table 5-15** shows the On-board SDRAM settings.

**Table 5-15: On-board SDRAM settings**

Register name	Setting values	Setting details
External Bus Control Register 3 (PFBCR3.SDCLKDRV)	0b0	Use the pin with the SDCLK set for a frequency no higher than 60 MHz.
Drive Capacity Control Register (PORT6.DSCR)	0b0000000x	Normal drive output
Drive Capacity Control Register 2 (PORT6.DSCR2)		
Drive Capacity Control Register (PORT7.DSCR)	0bxxxxxxx0	
Drive Capacity Control Register 2 (PORT7.DSCR2)		
Drive Capacity Control Register (PORTA.DSCR)	0b0000000x	
Drive Capacity Control Register 2 (PORTA.DSCR2)		
Drive Capacity Control Register (PORTB.DSCR)	0bx0000000	
Drive Capacity Control Register 2 (PORTB.DSCR2)		
Drive Capacity Control Register (PORTD.DSCR)	0b00000000	
Drive Capacity Control Register 2 (PORTD.DSCR2)		
Drive Capacity Control Register (PORTE.DSCR)		
Drive Capacity Control Register 2 (PORTE.DSCR2)		



### 5.13 Renesas Serial Peripheral Interface (RSPI)

The RX72N features three Renesas Serial Peripheral Interface modules (Renesas SPI or RSPI). RSPI1 is connected to a 32Mbit Serial Flash. **Table 5-16** below details the connected devices, and their connections to the MCU.

**Table 5-16: RSPI Connections**

RSPI Signal	Function	MCU	
		Port	Pin
RSPI-CS	Chip Select	PK3	J9
RSPI-CLK	Clock	PK0	M10
RSPI-MOSI	Master out slave in data	PK1	K9
RSPI-MISO	Master in slave out data	PK2	N11

### 5.14 Quad Serial Peripheral Interface (QSPI)

The RX72N features one Quad Serial Peripheral Interface module (QSPI). **Table 5-17** below details the connected device, and its connection to the MCU.

**Table 5-17: QSPI Connections**

QSPI signal	Function	MCU	
		Port	Pin
QSPI-CS	Chip Select	PN5	J11
QSPI-CLK	Clock	PN4	L12
QSPI-IO0	I/O Data0	PJ3	H7
QSPI-IO1	I/O Data1	PJ5	G5
QSPI-IO2	I/O Data2	P00	E3
QSPI-IO3	I/O Data3	P01	D5

### 5.15 I<sup>2</sup>C Bus (Inter-IC Bus)

The RX72N features three I<sup>2</sup>C (Inter-IC Bus) interface modules. RIIC1 is connected to a 2Kbit EEPROM. **Table 5-18** below details the connected device, and their connection to the MCU.

**Table 5-18: I<sup>2</sup>C Bus Connections**

I <sup>2</sup> C Bus signal	Function	MCU	
		Port	Pin
E2P-SDA	Data	P20	P3
E2P-SCL	Clock	P21	R1

## 5.16 SD Host Interface (SDHI)

A SD Card Slot is fitted to the CPU board, and connected to the SD Host Interface (SDHI) MCU peripheral. For further details regarding the SDHI operation, please refer to the RX72N Group User's Manual: Hardware. The connections for the SDHI signals are listed in **Table 5-19** below.

**Table 5-19: SDHI Connections**

SD Card Slot (SD1)							
Pin	Circuit Net Name	MCU		Pin	Circuit Net Name	MCU	
		Port	Pin			Port	Pin
1	SDHI-D3	PM5	R15	2	SDHI-CMD	PM1	F11
3	GROUND	-	-	4	SDHI-PE(SDHI-VCC)	PH4	K3
5	SDHI-CLK	PM0	G11	6	GROUND	-	-
7	SDHI-D0	PM2	K11	8	SDHI-D1	PM3	P15
9	SDHI-D2	PM4	P14	10	SDHI-CD	PM6	N13
11	GROUND	-	-	12	SDHI-WP	PM7	M13

## 5.17 Parallel Data Capture Unit Interface (PDC)

This CPU board is fitted with a Parallel Data Capture Unit (PDC) thru-hole pattern. The connections for the PDC signals are listed in **Table 5-20** below.

**Table 5-20: PDC Connections**

PDC Header (J19)							
Pin	Circuit Net Name	MCU		Pin	Circuit Net Name	MCU	
		Port	Pin			Port	Pin
1	Board_5V	-	-	2	Board_3V3	-	-
3	GROUND	-	-	4	GROUND	-	-
5	PDC-PCKO <sup>*1</sup>	P33	H4	6	PDC-RESn	RESn	G7
						PL5 <sup>*1</sup>	M11
7	GROUND	-	-	8	PDC-PIXCLK	P24	L4
9	PDC-VSYNC <sup>*1</sup>	P32	H5	10	PDC-HSYNC	P25	M3
11	PDC-PIXD7	P23	M2	12	PDC-PIXD6 <sup>*1</sup>	P22	N1
13	PDC-PIXD5 <sup>*1</sup>	P21	R1	14	PDC-PIXD4 <sup>*1</sup>	P20	P3
15	PDC-PIXD3 <sup>*1</sup>	P17	P2	16	PDC-PIXD2	P87	R2
17	PDC-PIXD1	P86	N3	18	PDC-PIXD0 <sup>*1</sup>	P15	J7
19	PDC-SSDA <sup>*1</sup>	PM2	K11	20	PDC-SSCL <sup>*1</sup>	PM1	F11

<sup>\*1</sup>: This connection is a not available in the default RSK+ configuration - refer to §6 for the required modifications.

## 5.18 Serial Sound Interface Enhanced (SSIE)

This CPU board is fitted with a Serial Sound Interface Enhanced Unit (SSIE) thru-hole pattern. The connections for the SSIE signals are listed in **Table 5-21** below.

**Table 5-21: SSIE Connections**

SSIE Header (J18)							
Pin	Circuit Net Name	MCU		Pin	Circuit Net Name	MCU	
		Port	Pin			Port	Pin
1	Board_5V	-	-	2	Board_3V3	-	-
3	GROUND	-	-	4	GROUND	-	-
5	SSI-AUDIOCLK <sup>*1</sup>	P22	N1	6	GROUND	-	-
7	GROUND	-	-	8	NC	-	-
9	SSI-SCK <sup>*1</sup>	P23	M2	10	SSI-RXD <sup>*1</sup>	PJ5	G5
11	SSI-LRCK	PF5	G6	12	SSI-TXD <sup>*1</sup>	P17	P2

<sup>\*1</sup>: This connection is a not available in the default RSK+ configuration - refer to §6 for the required modifications.

### 5.19 Graphic LCD Controller (GLCDC)

The RX72N features a graphic LCD controller (GLCDC) built in and is connected to via the FPC connector to NHD - 4.3 - 480272EF - ATXL - CTP manufactured by Newhaven Display International, Inc.

Table 5-22 and Table 5-23 show the connection relationship of the GLCDC interface.

**Table 5-22: GLCDC Connections(1)**

GLCDC (ONTFT1) *1							
Pin	Circuit Net Name	MCU		Pin	Circuit Net Name	MCU	
		Port	Pin			Port	Pin
1	OnTFT-LEDK	-	-	2	OnTFT-LEDA	-	-
3	GROUND	-	-	4	Board_3V3	-	-
5	OnTFT-R5(R0) *2	P81	L9	6	OnTFT-R6(R1) *2	P80	N10
7	OnTFT-R7(R2) *2	PC4	P11	8	OnTFT-R3	PC5	R10
9	OnTFT-R4	P82	P10	10	OnTFT-R5	P81	L9
11	OnTFT-R6	P80	N10	12	OnTFT-R7	PC4	P11
13	OnTFT-G6(G0) *2	PC7	N9	14	OnTFT-G7(G1) *2	PC6	R9
15	OnTFT-G2	P55	R8	16	OnTFT-G3	P54	R7
17	OnTFT-G4	P11	P8	18	OnTFT-G5	P83	M9
19	OnTFT-G6	PC7	N9	20	OnTFT-G7	PC6	R9
21	OnTFT-B5(B0) *2	P84	M6	22	OnTFT-B6(B1) *2	P57	P7
23	OnTFT-B7(B2) *2	P56	N7	24	OnTFT-B3	PJ0	M5
25	OnTFT-B4	P85	N4	26	OnTFT-B5	P84	M6
27	OnTFT-B6	P57	P7	28	OnTFT-B7	P56	N7
29	GROUND	-	-	30	OnTFT-CLK	P14	P4
31	OnTFT-DISP	PK4	F4	32	OnTFT-HSYNC	PJ2	L6
33	OnTFT-VSYNC	P13	N5	34	OnTFT-DEN	PJ1	N6
35	NC	-	-	36	GROUND	-	-
37	NC	-	-	38	NC	-	-
39	NC	-	-	40	NC	-	-

\*1: Connection driver: ST7282T2 manufactured by Sitronix Technology Corp.

\*2: Normalization from RGB 565 to RGB 888.

**Table 5-23: GLCDC Connections(2)**

GLCDC (ONTFT2)							
Pin	Circuit Net Name	MCU		Pin	Circuit Net Name	MCU	
		Port	Pin			Port	Pin
1	Board_3V3	-	-	2	GROUND	-	-
3	OnTFT-SCL*3	PQ1	E8	4	OnTFT-SDA*3	PQ2	G8
5	OnTFT-INT	P10	K7	6	OnTFT-RESn	RESn	G7
						PL3 *4	K10

\*3: Simple I2C bus is used for TFT touch interface.

Connection touch controller: FT5426 manufactured by Focal Tech, Inc.

Slave address (A6-0): 0111000.

\*4: This connection is a not available in the default RSK+ configuration - refer to §6 for the required modifications.

## 5.20 Unused terminal

The pins of the RX72N microcontroller not used on this board are connected to the header J6. **Table 5-24** shows the connection of unused pins.

**Table 5-24: Unused terminal**

Unused terminal(J6)							
Pin	Circuit Net Name	MCU		Pin	Circuit Net Name	MCU	
		Port	Pin			Port	Pin
1	P60TERM	P60	C10	2	P72TERM	P72	K15
3	P74TERM	P74	R14	4	P75TERM	P75	R13
5	P76TERPM	P76	N12	6	P77TERM	P77	L11
7	P92TERM	P92	A5	8	PH5TERM	PH5	K4
9	PK5TERM	PK5	F5	10	PK6TERM	PK6	F7

## 6. Configuration

### 6.1 Modifying the RSK+

This section lists the option links that are used to modify the way CPU board operates in order to access different configurations. Configurations are made by modifying link resistors or headers with movable jumpers or by configuration DIP switches

A link resistor is a 0Ω surface mount resistor, which is used to short or isolate parts of a circuit. Option links are listed in the following sections, detailing their function when fitted or removed. **Bold, blue text** indicates the default configuration that the CPU board is supplied with. Refer to the component placement diagram (§3) to locate the option links, jumpers and DIP switches.

When removing soldered components, always ensure that the CPU board is not exposed to a soldering iron for intervals greater than 5 seconds. This is to avoid damage to nearby components mounted on the board.

When modifying a link resistor, always check the related option links to ensure there is no possible signal contention or short circuits. Because many of the MCU's pins are multiplexed, some of the peripherals must be used exclusively. Refer to the RX72N Group User's Manual: Hardware and CPU board schematics for further information.

In the table in this section, "pin" expression is omitted, so please read as follows.  
 Example: U9.4 -> U9.4pin  
 J7(1-2 short) -> J7(1pin-2pin short)

### 6.2 MCU Operating Modes

Table 6-1 below details the option links associated with configuring the MCU Operating Modes.

**Table 6-1: MCU Operating Modes Switch Settings**

SW4 Pin1	SW4 Pin2	J15 *1	Configuration	Related Links
OFF	OFF (don't care)	Open (don't care)	Single Chip Mode	<a href="#">R274</a> , <a href="#">R275</a> , <a href="#">R40</a> , <a href="#">J11</a>
OFF	OFF	Open (don't care)	Boot Mode(FINE Interface) *2	<a href="#">R274</a> , <a href="#">R275</a> , <a href="#">R40</a> , <a href="#">J11</a>
ON	OFF	don't care	SCI Boot Mode	<a href="#">R274</a> , <a href="#">R275</a> , <a href="#">R40</a> , <a href="#">J11</a>
ON	ON	Open	USB Boot Mode (Bus-powered)	<a href="#">R274</a> , <a href="#">R275</a> , <a href="#">R40</a> , <a href="#">J11</a>
		Shorted	USB Boot Mode (Self-powered)	<a href="#">R274</a> , <a href="#">R275</a> , <a href="#">R40</a> , <a href="#">J11</a>

\*1: Jumper J15 is not mounted on the board at the time of product shipment.

\*2: To use the FINE interface, mode control by the E1 / E2 Lite debugger is required.

### 6.3 E1/E2 Lite Debugger Configuration

Table 6-2 below details the function of the option links associated with E1/E2 Lite Debugger Configuration.

**Table 6-2: E1/E2 Lite Debugger Configuration Option Links**

Signal name	MCU		MCU Peripheral Selection			Destination Selection		
	Pin	Port	Signal	Fit	DNF	Interface /Function	Fit	DNF
PC7	N9	PC7	OnTFT-G6	J11 (1-2pin short)	R275, R40	ONTFT1.13	-	-
			EMU-UB	J11 (2-3pin short)	R275, R40	ONTFT1.19	-	-
			DSW-UB			E1.10	-	-
			JA2-M1TRDCLK	R275	J11 (open), R40	JA2.26	-	-
EMU-TRSTn	F3	PF4	JA6-TXDc	R40	J11 (open), R275	JA6.9	-	-
EMU-TRSTn	F3	PF4	EMU-TRSTn	-	-	E1.3	-	-
EMU-TMS	J3	PF3	EMU-TMS	-	-	E1.9	-	-
PF2	J2	PF2	EMU-TDI_RXD	R338	R339, R123	E1.11	-	-
			SERIAL-RXD	R339	R338, R123	U15.3	-	R50, R337
			JA2-RXD <sub>a</sub>	R123	R338, R339	JA2.8	-	-
PF1	L3	PF1	EMU-TCK	R385, R11	R164	E1.1	-	-
			JA2-SCK <sub>a</sub>	R164, R11	R385	JA2.10	-	-
PF0	K5	PF0	EMU-TDO_TXD	R344	R343, R126	E1.5	-	-
			SERIAL-TXD	R343	R344, R126	U17.3	-	R51, R52
			JA2-TXD <sub>a</sub>	R126	R344, R343	JA2.6	-	-
RES <sub>n</sub>	G7	-	EMU-RES <sub>n</sub>	-	-	E1.13	-	-
			SW-RES <sub>n</sub>	-	-	RES1(Switch)	-	-
			JA2-RES <sub>n</sub>	-	-	JA2.1	-	-
			PDC-RES <sub>n</sub>	R137	R138	J19.6	R175	-
EMLE	F6	-	OnTFT-RES <sub>n</sub>	R128	R129	ONTFT2.6	R320	-
			EMU-EMLE	-	-	E1.4	-	-
MD_FINED	G4	-	JP-EMLE	-	-	J16.2	R111	-
			EMU-MD_FINED	-	-	E1.7	-	-
			DSW-MD_FINED	-	-	SW4.1	-	-

Table 6-3 below details the function of the jumpers associated with the E1/E2 Lite Debugger.

**Table 6-3: E1/E2 Lite Debugger Configuration Jumper Settings**

Reference	Jumper Position	Configuration	Related Links
J16(DNF) **	Shorted Pin1-2	Enable E1/E2 Lite normal debugging and MCU single operation (without E1/E2 Lite).	R111
	Shorted Pin2-3	Enable E1/E2 Lite debugging with Hot plug-in function.	
	All open	DO NOT SET.	-

\*\*1: Jumper J16 is not fitted on the default CPU board. Same as Jumper Position “shorted pin1-2” setting by resistor R111.

### 6.4 Power Supply Configuration

Table 6-4 below details the function of the option links associated with Power Supply Configuration.

**Table 6-4: Power Supply Configuration Option Links**

Reference	Configuration	Fit	DNF	Related Links
VBUS0	Connect 5V Power rail to VBUS0.	J17.shorted, J8.Pin1-2	-	U5.1, U5.2
Unregulated_VCC	Connect 5V power rail to Unregulated_VCC.	R405	-	U5.1, U5.2
JA1-5V	Connect 5V power rail to JA1-5V.	R415	-	U5.1, U5.2
USB_5V	Connect 5V power rail to USB_5V.	R416	-	U7.2, U7.3, U9.6
Board_5V	Connect 5V power rail to Board_5V.	-	-	U5.1, U5.2, U3.8
SD_3V3	Connect 3.3V power rail to SD_3V3.	R414	-	U6.2, U6.3
JA1-3V3	Connect 3.3V power rail to JA1-3V3.	R130	-	JA1.3
Board_3V3	Connect 3.3V power rail to Board_3V3.	-	-	U3.8 and many devices
UC_VCC	Connect 3.3V power rail to UC_VCC.	J14.Short or R85	-	U1, R13, R71, R81
	Enable current probe for measurement MCU current consumption.	-	J14.Open and R85	U1, R13, R71, R81
VBATT	Connect UC_VCC power rail to VBATT.	R83	R84	U1
	J13 connected to VBATT of MCU	R84	R83	U1

\*1: J13 is a power connector for VBATT, not a jumper. Do not short-circuit J13 Pin 1 and Pin 2 because the power supply is directly connected to ground.

Table 6-5 below details the function of the jumpers associated with the Power Supply Configuration.

**Table 6-5: Power Supply Configuration Jumper Settings**

Reference	Jumper Position	Configuration	Related Links
J14(DNF) *1	Shorted	Connect 3.3V power rail to UC_VCC.	R85
	All open	Enable current probe for measurement MCU current consumption.	
J17(DNF) *2	Shorted	Enable VBUS0.	J9
	All open	Disable VBUS0	J9

\*1: Jumper J14 is not fitted on the default CPU board. Fitting resistor R85 has the same effect as "shorting" jumper J14.

\*2: Jumper J17 is not fitted on the default CPU board.

### 6.5 Clock Configuration

Table 6-6 below details the function of the option links associated with Clock Configuration.

**Table 6-6: Clock Configuration Option Links**

Reference	Configuration	Fit	DNF	Related Links
XTAL, EXTAL	Connect 24MHz crystal (X1) to RX72N.	R19, R24	R17, R29	U1.H1, U1.J1
	Connect JA2-EXTAL to RX72N.	R17	R19, R24, R29	U1.J1
XCIN, XCOUT	Connect 32.768kHz crystal (X2) to RX72N.	R38, R33	R41, R37	U1.F1, U1.G1
	Disconnect X2 from RX72N.	R41	R38, R33, R37	-

### 6.6 Analog Power, ADC and DAC Configuration

Table 6-7 below details the function of the option links associated with Analog Power, ADC and DAC Configuration.

**Table 6-7: Analog Power, ADC and DAC Configuration Option Links**

Signal name	MCU		MCU Peripheral Selection			Destination Selection		
	Pin	Pot	Signal	Fit	DNF	Interface /Function	Fit	DNF
P07 <sup>*1</sup>	E5	P07	SW3	R88	R124, R89	SW3	-	-
			JA1-ADTRG	R124	R88, R89	JA1.8	R124	R292
			JA1-IRQd	R89	R88, R124	JA1.23	-	-
JA1-DAC1	C3	P05	JA1-DAC1	-	-	JA1.14	-	-
P03	D3	P03	SERIAL-CTS	R105	R106	U15.2	-	-
			JA1-DAC0	R106	R105	JA1.13	-	-
P13	N5	P13	OnTFT-VSYNC	R293	R292	ONTFT1.33	-	-
			JA1-ADTRG	R292	R293	JA1.8	R292	R124
P43	E4	P43	SERIAL-RTS	R108	R109	U17.2	-	-
			JA1-ADC3	R109	R108	JA1.12	-	-
JA1-ADC2	B3	P42	JA1-ADC2	-	-	JA1.11	-	-
P41	A4	P41	SDHI-POWFLT	R120	R121	U6.5	-	-
			JA1-ADC1	R121	R120	JA1.10	-	-
P40	D4	P40	RV1-ADC	R116	R117	RV1	-	-
			JA1-ADC0	R117	R116	JA1.9	-	-
PE5	C13	PE5	SDRAM-D13	R56	R57	U12.50	-	-
			JA3-D13			JA3.34	-	-
			JA5-ADC7	R57	R56	JA5.4	-	-
PE4	B14	PE4	SDRAM-D12	R53	R54	U12.48	-	-
			JA3-D12			JA3.33	-	-
			JA5-ADC6	R54	R53	JA5.3	-	-
PE3	D12	PE3	SDRAM-D11	R65	R66	U12.47	-	-
			JA3-D11			JA3.32	-	-
			JA5-ADC5	R66	R65	JA5.2	-	-
PE2	B13	PE2	SDRAM-D10	R61	R62	U12.45	-	-
			JA3-D10			JA3.31	-	-
			JA5-ADC4	R62	R61	JA5.1	-	-
VREFH0	A2	-	UC_VCC	R81	R76	-	-	-
			JA1-VREFH	R76	R81	JA1.7	-	-
VREFL0	A3	-	GROUND	R96	R93	-	-	-
			JA1-AVSS	R93	R96	JA1.6	-	-
AVCC0-1	B2, C2	-	UC_VCC	R71	R171, R67 or R172, R67	-	-	-
			JA1-AVCC	R67	R171, R71 or R172, R71	JA1.5	-	-
			Board_3V3	R171, R172	R71, R67	-	-	-
AVSS0-1	B1, C1	-	GROUND	R58	R55	-	-	-
			JA1-AVSS	R55	R58	JA1.6	-	-

\*1: When changing the option link of P07, pay attention to the presence or absence of a pull-up resistor. Leave the pull-up resistor for SW3 (R194) fitted, otherwise the internal pull-up in the MCU will need to be enabled.



## 6.7 BUS & SDRAM Configuration

Table 6-8, Table 6-9, Table 6-10 below details the function of the option links associated with BUS & SDRAM Configuration.

**Table 6-8: BUS & SDRAM Configuration Option Links(1)**

Signal name	MCU		MCU Peripheral Selection			Destination Selection		
	P <sub>in</sub>	Port	Signal	Fit	DNF	Interface /Function	Fit	DNF
P10	K7	P10	OnTFT-INT	R263	R262, R27	ONTFT2.5	-	-
			JA3-ALE	R262	R263, R27	JA3.46	R361	R155
			JA6-M1WIN	R27	R263, R262	JA6.16	-	-
JA3-CSc	M1	P26	JA3-CSc	-	-	JA3.45	R15	R154
JA3-BCLK	J8	P53	JA3-BCLK	R142	-	JA3.44	R153	R363
P52	L8	P52	JA3-RDn	R149	R139	JA3.25	-	-
			PMOD2-MISO	R139	R149	PMOD2.3	-	-
P51	M8	P51	JA3-WRHn	R148, R131	R132	JA3.47	R157	R359
			PMOD2-SCK	R132, R131	R148	PMOD2.4	-	-
P50	K8	P50	JA3-WRn	R140	R352, R353	JA3.26	R150	R366
			JA3-WRLn	R352	R140, R353	JA3.48	R156	R360
			PMOD2-MOSI	R353	R140, R352	PMOD2.2	-	-
P67	D15	P67	SDRAM-DQMH	R350	R349	U12.39	-	-
			JA3-DQMH	R349	R350	JA3.47	R359	R157
P66	C15	P66	SDRAM-DQML	R146	R147	U12.15	-	-
			JA3-DQML	R147	R146	JA3.48	R360	R156
P65	C14	P65	SDRAM-CKE	R144	R145	U12.37	-	-
			JA3-CKE	R145	R144	JA3.46	R155	R361
P64	C11	P64	SDRAM-WEn	R355	R354	U12.16	-	-
			JA3-WEn	R354	R355	JA3.26	R366	R150
P63	B12	P63	SDRAM-CASn	-	-	U12.17	-	-
			JA3-CAS	-	-	JA3.49	-	-
P62	A13	P62	SDRAM-RASn	-	-	U12.18	-	-
			JA3-RAS	-	-	JA3.50	-	-
P61	A12	P61	SDRAM-SDCSn	R141	R151	U12.19	-	-
			JA3-CSb	R151	R141	JA3.28	-	-
JA3-CSa	H10	P73	JA3-CSa	R152	-	JA3.27	-	-
P70	A15	P70	SDRAM-SDCLK	R335, R334	R333	U12.38	-	-
			JA3-SDCLK	R333, R334	R335	JA3.44	R363	R153
PA7	J15	PA7	SDRAM-A7	-	-	U12.31	-	-
			JA3-A7	-	-	JA3.8	-	-
PA6	H14	PA6	SDRAM-A6	-	-	U12.30	-	-
			JA3-A6	-	-	JA3.7	-	-
PA5	H15	PA5	SDRAM-A5	-	-	U12.29	-	-
			JA3-A5	-	-	JA3.6	-	-
PA4	G15	PA4	SDRAM-A4	-	-	U12.26	-	-
			JA3-A4	-	-	JA3.5	-	-
PA3	G14	PA3	SDRAM-A3	-	-	U12.25	-	-
			JA3-A3	-	-	JA3.4	-	-
PA2	G13	PA2	SDRAM-A2	-	-	U12.24	-	-
			JA3-A2	-	-	JA3.3	-	-
PA1	G12	PA1	SDRAM-A1	-	-	U12.23	-	-
			JA3-A1	-	-	JA3.2	-	-

**Table 6-9: BUS & SDRAM Configuration Option Links(2)**

Signal name	MCU		MCU Peripheral Selection			Destination Selection		
	Pin	Port	Signal	Fit	DNF	Interface /Function	Fit	DNF
JA3-A0	F12	PA0	JA3-A0	-	-	JA3.1	-	-
JA3-A15	N15	PB7	JA3-A15	-	-	JA3.16	-	-
PB6	M15	PB6	SDRAM-A14	-	-	U12.21	-	-
			JA3-A14	-	-	JA3.15	-	-
PB5	K13	PB5	SDRAM-A13	-	-	U12.20	-	-
			JA3-A13	-	-	JA3.14	-	-
PB4	L15	PB4	SDRAM-A12	-	-	U12.35	-	-
			JA3-A12	-	-	JA3.13	-	-
PB3	K14	PB3	SDRAM-A11	-	-	U12.22	-	-
			JA3-A11	-	-	JA3.12	-	-
PB2	L14	PB2	SDRAM-A10	-	-	U12.34	-	-
			JA3-A10	-	-	JA3.11	-	-
PB1	J12	PB1	SDRAM-A9	-	-	U12.33	-	-
			JA3-A9	-	-	JA3.10	-	-
PB0	J14	PB0	SDRAM-A8	-	-	U12.32	-	-
			JA3-A8	-	-	JA3.9	-	-
PC6	R9	PC6	JA3-A22	R278	R279	JA3.43	-	-
			OnTFT-G7	R279	R278	ONTFT1.14 ONTFT1.20	-	-
PC5	R10	PC5	JA3-A21	R272	R273	JA3.42	-	-
			OnTFT-R3	R273	R272	ONTFT1.8	-	-
PC4	P11	PC4	OnTFT-R7	R302, R296	R301, R90	ONTFT1.7 ONTFT1.12	-	-
			JA3-A20	R301, R296	R302, R90	JA3.41	-	-
			JA2-M1POE	R90, R296	R302, R301	JA2.24	-	-
JA3-A19	R11	PC3	JA3-A19	-	-	JA3.40	-	-
JA3-A18	P13	PC2	JA3-A18	-	-	JA3.39	-	-
PC1	N14	PC1	JA3-A17	R32	R31	JA3.38	-	-
			JA6-M1TOGGLE	R31	R32	JA6.13	-	-
JA3-A16	M14	PC0	JA3-A16	-	-	JA3.37	-	-
PD7	A11	PD7	SDRAM-D7	-	-	U12.13	-	-
			JA3-D7	-	-	JA3.24	-	-
PD6	B10	PD6	SDRAM-D6	-	-	U12.11	-	-
			JA3-D6	-	-	JA3.23	-	-
PD5	D9	PD5	SDRAM-D5	-	-	U12.10	-	-
			JA3-D5	-	-	JA3.22	-	-
PD4	B9	PD4	SDRAM-D4	-	-	U12.8	-	-
			JA3-D4	-	-	JA3.21	-	-
PD3	A9	PD3	SDRAM-D3	-	-	U12.7	-	-
			JA3-D3	-	-	JA3.20	-	-
PD2	A7	PD2	SDRAM-D2	-	-	U12.5	-	-
			JA3-D2	-	-	JA3.19	-	-
PD1	C7	PD1	SDRAM-D1	-	-	U12.4	-	-
			JA3-D1	-	-	JA3.18	-	-
PD0	A6	PD0	SDRAM-D0	-	-	U12.2	-	-
			JA3-D0	-	-	JA3.17	-	-

**Table 6-10: BUS & SDRAM Configuration Option Links(3)**

Signal name	MCU		MCU Peripheral Selection			Destination Selection		
	Pin	Port	Signal	Fit	DNF	Interface /Function	Fit	DNF
PE7	B15	PE7	SDRAM-D15	-	-	U12.53	-	-
			JA3-D15	-	-	JA3.36	-	-
PE6	E13	PE6	SDRAM-D14	-	-	U12.51	-	-
			JA3-D14	-	-	JA3.35	-	-
PE5	C13	PE5	SDRAM-D13	R56	R57	U12.50	-	-
			JA3-D13			JA3.34	-	-
			JA5-ADC7	R57	R56	JA5.4	-	-
PE4	B14	PE4	SDRAM-D12	R53	R54	U12.48	-	-
			JA3-D12			JA3.33	-	-
			JA5-ADC6	R54	R53	JA5.3	-	-
PE3	D12	PE3	SDRAM-D11	R65	R66	U12.47	-	-
			JA3-D11			JA3.32	-	-
			JA5-ADC5	R66	R65	JA5.2	-	-
PE2	B13	PE2	SDRAM-D10	R61	R62	U12.45	-	-
			JA3-D10			JA3.31	-	-
			JA5-ADC4	R62	R61	JA5.1	-	-
PE1	A14	PE1	SDRAM-D9	-	-	U12.44	-	-
			JA3-D9	-	-	JA3.30	-	-
PE0	D11	PE0	SDRAM-D8	-	-	U12.42	-	-
			JA3-D8	-	-	JA3.29	-	-
PF5	G6	PF5	SSI-LRCK	R351	R143	J18.11	-	-
			JA3-WAIT	R143	R351	JA3.45	R154	R15

## 6.8 CAN Configuration

Table 6-11 below details the function of the option links associated with CAN Configuration.

**Table 6-11: CAN Configuration Option Links**

Signal name	MCU		MCU Peripheral Selection			Destination Selection		
	Pin	Port	Signal	Fit	DNF	Interface /Function	Fit	DNF
P33	H4	P33	CAN1RX	R46, R48	R43, R49	U4.4	-	-
			PDC-PCKO	R43, R48	R46, R49	J19.5	-	-
			JA5-CAN1RX	R49, R48	R46, R43	JA5.6	-	-
P32	H5	P32	CAN1TX	R300	R87, R47, R295	U16.3	-	-
			JA2-IRQc_M1HSIN2	R87	R300, R47, R295	JA2.23	R86	R91
			JA5-CAN1TX	R47	R300, R87, R295	JA5.5	-	-
			PDC-VSYNC	R295	R300, R87, R47	J19.9	-	-

### 6.9 Ethernet Configuration

Table 6-12, Table 6-13 below details the function of the option links associated with Ethernet Configuration.

**Table 6-12: Ethernet Configuration Option Links**

Signal name	MCU		MCU Peripheral Selection			Destination Selection		
	Pin	Port	Signal	Fit	DNF	Interface /Function	Fit	DNF
ET1-ERXD3	C9	P97	ET1-ERXD3	-	-	U13.13	-	-
ET1-ERXD2	A8	P96	ET1-ERXD2	-	-	U13.14	-	-
ET1-ERXD1_RMII1RXD1	B8	P95	ET1-ERXD1_RMII1RXD1	-	-	U13.15	-	-
ET1-ERXD0_RMII1RXD0	B7	P94	ET1-ERXD0_RMII1RXD0	-	-	U13.16	-	-
ET1-LED0	D7	P93	ET1-LED0	-	-	ETHERNET.11 U13.30	-	-
ET1-COL	B5	P91	ET1-COL	-	-	U13.28	-	-
ET1-RXDV	C6	P90	ET1-RXDV_RMII1CRSDV	R39	R276	U13.18	-	-
ET1-RXER_RMII1RXER	H9	PN3	ET-ET1RXER_RMII1RXER	-	-	U13.20	-	-
ET1-TXCLK	G9	PN2	ET1-TXCLK	R10	-	U13.22	-	-
ET1-ETXD3	F8	PN1	ET1-ETXD3	-	-	U13.27	-	-
ET1-ETXD2	E6	PN0	ET1-ETXD2	-	-	U13.26	-	-
ET1-TXEN_RMII1TXDEN	H8	PQ7	ET1-TXEN_RMII1TXDEN	-	-	U13.23	-	-
ET1-ETXD1_RMII1TXD1	F9	PQ6	ET1-ETXD1_RMII1TXD1	-	-	U13.25	-	-
ET1-ETXD0_RMII1TXD0	E10	PQ5	ET1-ETXD0_RMII1TXD0	-	-	U13.24	-	-
ET1-RXCLK	E11	PQ4	ET1-RXCLK	R9	-	U13.19 U14.2	R226 R225	R225 R226
PQ0	E7	PQ0	ET1-RXDV_RMII1CRSDV ET1-CRS	R276 R42, R39	R39, R42 R276	U13.18 U13.29	-	-

**Table 6-13: Ethernet Configuration Option Links**

Signal name	MCU		MCU Peripheral Selection			Destination Selection		
	Pin	Port	Signal	Fit	DNF	Interface /Function	Fit	DNF
P15	J7	P15	ET-INTn	R336	R118, R119	U13.21	-	-
			JA2-IRQb-M1HSIN1	R118	R336, R119	JA2.9	-	-
			PDC-PIXD0	R119	R336, R118	J19.18	-	-
P31	J4	P31	ET-MDC	R218	R3	U13.12	-	-
			JA2-CTSaRTSa	R3	R218	JA2.12	-	-
P30	J5	P30	ET-MDIO	R216	R100, R95	U13.11	-	-
			JA2-M1WP	R100	R216, R95	JA2.17	-	-
			JA2-TIMIN0	R95	R216, R100	JA2.21	-	-
CLKOUT25M	K1	PH7	CLKOUT25M	R16	-	U13.9	R243	R244
ET-GPIORST *1	R12	PL4	ET-GPIORST	R245, R254, C72	R410	U13.32	-	-
SW-PHYRESn *1	-	-	SW-PHYRESn	R410	-			

\*1: In the default RSK+ configuration, ET-GPIORST signal and SW-PHYRESn signal are connected to the reset pin of the Ethernet controller IC (U13). Normally, reset is activated by SW-PHYRESn, so set port PL4 (ET-GPIORST) of the RX72N in the input direction. When using ET-GPIORST as a reset, configure as shown in Table 6-13 above.

Table 6-14 below details the function of the jumpers associated with the Ethernet Configuration.

**Table 6-14: Ethernet Configuration Option Links(PHY Mode)**

PHY Mode	Config Placement	Reference	Related Links
MII Mode	Fit	R266, R243, R226, R39, R42	U13, U14
	DNF	R225, R244, R249, R276	
RMII Mode	DNF	R266, R243, R226, R39, R42	U13, U14
	Fit	R225, R244, R249, R276	

## 6.10 General IO & LED Configuration

Table 6-15 below details the function of the option links associated with General IO & LED Configuration.

**Table 6-15: General IO & LED Configuration Option Links**

Signal name	MCU		MCU Peripheral Selection			Destination Selection		
	Pin	Port	Signal	Fit	DNF	Interface /Function	Fit	DNF
LED0	J13	P71	LED0	-	-	LED0.K	R193	-
ET1-LED0	D7	P93	ET1-LED0	-	-	ETHERNET.11	-	-
						U13.30	-	-
JA1-IO7	F15	PG7	JA1-IO7	-	-	JA1.22	-	-
JA1-IO6	F14	PG6	JA1-IO6	-	-	JA1.21	-	-
JA1-IO5	E14	PG5	JA1-IO5	-	-	JA1.20	-	-
JA1-IO4	E15	PG4	JA1-IO4	-	-	JA1.19	-	-
JA1-IO3	F13	PG3	JA1-IO3	-	-	JA1.18	-	-
JA1-IO2	D14	PG2	JA1-IO2	-	-	JA1.17	-	-
JA1-IO1	D10	PG1	JA1-IO1	-	-	JA1.16	-	-
JA1-IO0	A10	PG0	JA1-IO0	-	-	JA1.15	-	-
LED1	K2	PH6	LED1	-	-	LED1.K	R193	-
LED2	L10	PL7	LED2	-	-	LED2.K	R193	-
LED3	M12	PL6	LED3	-	-	LED3.K	R193	-

## 6.11 GLCDC Configuration

Table 6-16 and Table 6-17 below details the function of the option links associated with GLCDC Configuration.

**Table 6-16: GLCDC Configuration Option Links(1)**

Signal name	MCU		MCU Peripheral Selection			Destination Selection		
	Pin	Port	Signal	Fit	DNF	Interface /Function	Fit	DNF
P14	P4	P14	OnTFT-CLK	R294, R299	R74, J12(open)	ONTFT1.30	-	-
			JA2-M1TRCCLK	R74, R299	R294, J12(open)	JA2.25	-	-
			USB0-OVRCURA	J12(short) R299	R294, R74, R282	U9.3	J10 (2-3pin short) or R26	J10 (1-2pin open) and R25
P13	N5	P13	OnTFT-VSYNC	R293	R292	ONTFT1.33	-	-
			JA1-ADTRG	R292	R293	JA1.8	R292	R124
P11	P8	P11	OnTFT-G4	R261	R28	ONTFT1.17	-	-
			JA6-M1VIN	R28	R261	JA6.15	-	-
P10	K7	P10	OnTFT-INT	R263	R262, R27	ONTFT2.5	-	-
			JA3-ALE	R262	R263, R27	JA3.46	R361	R155
			JA6-M1WIN	R27	R263, R262	JA6.16	-	-
OnTFT-BACKLIGHT	L2	P27	OnTFT-BACKLIGHT	-	-	U8.3	-	-
OnTFT-B6	P7	P57	OnTFT-B6	-	-	ONTFT1.22	-	-
						ONTFT1.27	-	-
OnTFT-B7	N7	P56	OnTFT-B7	-	-	ONTFT1.23	-	-
						ONTFT1.28	-	-
OnTFT-G2	R8	P55	OnTFT-G2	-	-	ONTFT1.15	-	-
OnTFT-G3	R7	P54	OnTFT-G3	-	-	ONTFT1.16	-	-
OnTFT-B4	N4	P85	OnTFT-B4	-	-	ONTFT1.25	-	-
OnTFT-B5	M6	P84	OnTFT-B5	-	-	ONTFT1.21	-	-
						ONTFT1.26	-	-
P83	M9	P83	OnTFT-G5	R271, R36	R35	ONTFT1.18	-	-
			JA6-SCKc	R35, R36	R271	JA6.11	-	-
OnTFT-R4	P10	P82	OnTFT-R4	-	-	ONTFT1.9	-	-

**Table 6-17: GLCDC Configuration Option Links(2)**

Signal name	MCU		MCU Peripheral Selection			Destination Selection		
	Pi	Pot	Signal	Fit	DNF	Interface /Function	Fit	DNF
P81	L9	P81	OnTFT-R5	R321	R107	ONTFT1.5	-	-
						ONTFT1.10	-	-
			JA2-M1UN	R107	R321	JA2.14	-	-
OnTFT-R6	N10	P80	OnTFT-R6	-	-	ONTFT1.6	-	-
						ONTFT1.11	-	-
PC7	N9	PC7	OnTFT-G6	J11 (1-2pin short)	R275, R40	ONTFT1.13	-	-
						ONTFT1.19	-	-
			EMU-UB	J11 (2-3pin short)	R275, R40	E1.10	-	-
			DSW-UB			SW4.2	-	-
			JA2-M1TRDCLK	R275	J11 (open), R40	JA2.26	-	-
		JA6-TXDc	R40	J11 (open), R275	JA6.9	-	-	
PC6	R9	PC6	JA3-A22	R278	R279	JA3.43	-	-
			OnTFT-G7	R279	R278	ONTFT1.14	-	-
						ONTFT1.20	-	-
PC5	R10	PC5	JA3-A21	R272	R273	JA3.42	-	-
			OnTFT-R3	R273	R272	ONTFT1.8	-	-
PC4	P11	PC4	OnTFT-R7	R302, R296	R301, R90	ONTFT1.7	-	-
						ONTFT1.12	-	-
			JA3-A20	R301, R296	R302, R90	JA3.41	-	-
		JA2-M1POE	R90, R296	R302, R301	JA2.24	-	-	
OnTFT-HSYNC	L6	PJ2	OnTFT-HSYNC	-	-	ONTFT1.32	-	-
OnTFT-DEN	N6	PJ1	OnTFT-DEN	-	-	ONTFT1.34	-	-
OnTFT-B3	M5	PJ0	OnTFT-B3	-	-	ONTFT1.24	-	-
OnTFT-DISP	F4	PK4	OnTFT-DISP	-	-	ONTFT1.31	-	-
OnTFT-RESn	K10	PL3	OnTFT-RESn	R129	R128	ONTFT2.6	R320	-
OnTFT-SDA	G8	PQ2	OnTFT-SDA	-	-	ONTFT2.4	-	-
OnTFT-SCL	E8	PQ1	OnTFT-SCL	-	-	ONTFT2.3	-	-
RESn	G7	-	EMU-RESn	-	-	E1.13	-	-
			SW-RESn	-	-	RES1(Switch)	-	-
			JA2-RESn	-	-	JA2.1	-	-
			PDC-RESn	R137	R138	J19.6	R175	-
			OnTFT-RESn	R128	R129	ONTFT2.6	R320	-

### 6.12 I2C & EEPROM Configuration

Table 6-18 and Table 6-19 below detail the function of the option links associated with I2C & EEPROM Configuration.

**Table 6-18: I2C & EEPROM Configuration Option Links (1)**

Signal name	MCU		MCU Peripheral Selection			Destination Selection		
	Pin	Port	Signal	Fit	DNF	Interface /Function	Fit	DNF
P21	R1	P21	E2P-SCL	R75, R79	R78	U3.6	-	-
			JA1-SCL			JA1.26	-	-
			PDC-PIXD5	R78	R75, R79	J19.13	-	-
P20	P3	P20	E2P-SDA	R72, R73	R69, R70	U3.5	-	-
			JA1-SDA			JA1.25	-	-
			PDC-PIXD4	R69	R72, R73, R70	J19.14	-	-
			JA2-M1ENC	R70	R72, R73, R69	JA2.23	R91	R86

**Table 6-19: I2C & EEPROM Configuration Option Links (2)**

Reference	Configuration	Fit	DNF	Related Links
SDA1, SCL1	Connect pull-up resistor to Board_3V3.	R113	R114	U3
	Connect pull-up resistor to Board_5V.	R114	R113	U3
WP	EEPROM Write protect.	R326	-	U3
A0, A1, A2	Device address (0xA6).	R329, R328, R340	R342, R341, R327	U3
	Device address (0xA4).	R342, R328, R340	R329, R341, R327	U3

### 6.13 IRQ & Switch Configuration

Table 6-20 and Table 6-21 below details the function of the option links associated with IRQ & Switch Configuration.

**Table 6-20: IRQ & Switch Configuration Option Links (1)**

Signal name	MCU		MCU Peripheral Selection			Destination Selection		
	Pin	Port	Signal	Fit	DNF	Interface /Function	Fit	DNF
P07 <sup>*1</sup>	E5	P07	SW3	R88	R124, R89	SW3	-	-
			JA1-ADTRG	R124	R88, R89	JA1.8	R124	R292
			JA1-IRQd	R89	R88, R124	JA1.23	-	-
P03	D3	P03	SERIAL-CTS	R105	R106	U15.2	-	-
			JA1-DAC0	R106	R105	JA1.13	-	-
PMOD1-IO1	D6	P02	PMOD1-IO1	-	-	PMOD1.8	-	-
P00	E3	P00	QSPI-IO2	R324	R323	U11.3	-	-
			PMOD2-IO1	R323	R324	PMOD2.8	-	-
P17	P2	P17	PMOD1-IO0	R280	R44, R281, R277	PMOD1.7	-	-
			JA6-TXDb	R44	R280, R281, R277	JA6.8	-	-
			PDC-PIXD3	R281	R280, R44, R277	J19.15	-	-
			SSI-TXD	R277	R280, R44, R281	J18.12	-	-
P15	J7	P15	ET-INTn	R336	R118, R119	U13.21	-	-
			JA2-IRQb-M1HSIN1	R118	R336, R119	JA2.9	-	-
			PDC-PIXD0	R119	R336, R118	J19.18	-	-
P10	K7	P10	OnTFT-INT	R263	R262, R27	ONTFT2.5	-	-
			JA3-ALE	R262	R263, R27	JA3.46	R361	R155
			JA6-M1WIN	R27	R263, R262	JA6.16	-	-
P35	H3	P35	JP-UPSEL	-	-	J15.2	-	-
			JA2-NMIIn	R127	-	JA2.3	-	-
JA2-IRQa-M1HSIN0	H2	P34	JA2-IRQa-M1HSIN0	-	-	JA2.7	-	-
P32	H5	P32	CAN1TX	R300	R87, R47, R295	U16.3	-	-
			JA2-IRQc_M1HSIN2	R87	R300, R47, R295	JA2.23	R86	R91
			JA5-CAN1TX	R47	R300, R87, R295	JA5.5	-	-
			PDC-VSYNC	R295	R300, R87, R47	J19.9	-	-

\*1: When changing the option link of P07, pay attention to the presence or absence of a pull-up resistor. Leave the pull-up resistor for SW3 (R194) fitted, otherwise the internal pull-up in the MCU will need to be enabled.

**Table 6-21: IRQ & Switch Configuration Option Links (2)**

Signal name	MCU		MCU Peripheral Selection			Destination Selection		
	Pin	Port	Signal	Fit	DNF	Interface /Function	Fit	DNF
P30	J5	P30	ET-MDIO	R216	R100, R95	U13.11	-	-
			JA2-M1WP	R100	R216, R95	JA2.17	-	-
			JA2-TIMIN0	R95	R216, R100	JA2.21	-	-
PMOD2-IO0	B4	P46	PMOD2-IO0	-	-	PMOD2.7	-	-
SW1	D1	P45	SW1	-	-	SW1	-	-
SW2	C4	P44	SW2	-	-	SW2	-	-
P41	A4	P41	SDHI-POWFLT	R120	R121	U6.5	-	-
			JA1-ADC1	R121	R120	JA1.10	-	-
PC7	N9	PC7	OnTFT-G6	J11 (1-2pin short)	R275, R40	ONTFT1.13	-	-
			EMU-UB	J11 (2-3pin short)	R275, R40	ONTFT1.19	-	-
			DSW-UB			E1.10	-	-
			JA2-M1TRDCLK	R275	J11 (open), R40	JA2.26	-	-
			JA6-TXDc	R40	J11 (open), R275	JA6.9	-	-
MD_FINED	G4	-	EMU-MD_FINED	-	-	E1.7	-	-
			DSW-MD_FINED	-	-	SW4.1	-	-
RESn	G7	-	EMU-RESn	-	-	E1.13	-	-
			SW-RESn	-	-	RES1(Switch)	-	-
			JA2-RESn	-	-	JA2.1	-	-
			PDC-RESn	R137	R138	J19.6	R175	-
			OnTFT-RESn	R128	R129	ONTFT2.6	R320	-

### 6.14 MTU & POE Configuration

Table 6-22 and Table 6-23 below details the function of the option links associated with MTU & POE Configuration.

**Table 6-22: MTU & POE Configuration Option Links (1)**

Signal name	MCU		MCU Peripheral Selection			Destination Selection		
	Pin	Port	Signal	Fit	DNF	Interface /Function	Fit	DNF
P16	R3	P16	USB0-VBUS	J7(1-2 short), J9(1-2 short) or R7	R115	USB0_2.1	J8(1-2 short), R2	-
			USB0-VBUSEN	J7(2-3 short)	R115	U7.4	-	-
			JA2-M1UD	R115	J7(Open)	JA2.11	-	-
P15	J7	P15	ET-INTn	R336	R118, R119	U13.21	-	-
			JA2-IRQb-M1HSIN1	R118	R336, R119	JA2.9	-	-
			PDC-PIXD0	R119	R336, R118	J19.18	-	-
P14	P4	P14	OnTFT-CLK	R294, R299	R74, J12(open)	ONTFT1.30	-	-
			JA2-M1TRCCLK	R74, R299	R294, J12(open)	JA2.25	-	-
			USB0-OVRCURA	J12(short) , R299	R294, R74, R282	U9.3	J10 (2-3pin short) or R26	J10 (1-2pin open) and R25
P11	P8	P11	OnTFT-G4	R261	R28	ONTFT1.17	-	-
			JA6-M1VIN	R28	R261	JA6.15	-	-
P10	K7	P10	OnTFT-INT	R263	R262, R27	ONTFT2.5	-	-
			JA3-ALE	R262	R263, R27	JA3.46	R361	R155
			JA6-M1WIN	R27	R263, R262	JA6.16	-	-
P25	M3	P25	PDC-HSYNC	R317	R103, R97, R45	J19.10	-	-
			JA2-M1VN	R103	R317, R97, R45	JA2.16	-	-
			JA2-TIMOUT1	R97	R317, R103, R45	JA2.20	-	-
			JA6-RXDc	R45	R317, R103, R97	JA6.7	-	-
P24	L4	P24	PDC-PIXCLK	R304, R99	R104, R303, R98	J19.8	-	-
			JA2-M1VP	R104, R99	R304, R303, R98	JA2.15	-	-
			JA6-SCKb	R303, R99	R304, R104, R98	JA6.10	-	-
			JA2-TIMOUT0	R98, R99	R304, R104, R303	JA2.19	-	-



**Table 6-23: MTU & POE Configuration Option Links (2)**

Signal name	MCU		MCU Peripheral Selection			Destination Selection		
	Pin	Port	Signal	Fit	DNF	Interface /Function	Fit	DNF
P22	N1	P22	<b>USB0-OVRCURB</b>	<b>R282, R60</b>	<b>R64, R286, R68, R59</b>	<b>U9.3</b>	<b>J10 (1-2pin short) or R25</b>	<b>J10 (2-3pin short) and R26</b>
			PDC-PIXD6	R64, <b>R60</b>	R282, <b>R286, R68, R59</b>	J19.12	-	-
			SSI-AUDIOCLK	R286, <b>R60</b>	R282, <b>R64, R68, R59</b>	J18.5	-	-
			JA2-M1UP	R68, <b>R60</b>	R282, <b>R64, R286, R59</b>	JA2.13	-	-
			JA6-DREQ	R59, <b>R60</b>	R282, <b>R64, R286, R68</b>	JA6.1	-	-
P20	P3	P20	<b>E2P-SDA</b>	<b>R72, R73</b>	<b>R69, R70</b>	<b>U3.5</b>	-	-
			<b>JA1-SDA</b>			<b>JA1.25</b>	-	-
			PDC-PIXD4	R69	R72, R73, <b>R70</b>	J19.14	-	-
			JA2-M1ENC	R70	R72, R73, <b>R69</b>	JA2.23	R91	R86
JA2-IRQa-M1HSIN0	H2	P34	<b>JA2-IRQa-M1HSIN0</b>	-	-	<b>JA2.7</b>	-	-
P32	H5	P32	<b>CAN1TX</b>	<b>R300</b>	<b>R87, R47, R295</b>	<b>U16.3</b>	-	-
			JA2-IRQc_M1HSIN2	R87	R300, <b>R47, R295</b>	JA2.23	<b>R86</b>	<b>R91</b>
			JA5-CAN1TX	R47	R300, <b>R87, R295</b>	JA5.5	-	-
			PDC-VSYNC	R295	R300, <b>R87, R47</b>	J19.9	-	-
P30	J5	P30	<b>ET-MDIO</b>	<b>R216</b>	<b>R100, R95</b>	<b>U13.11</b>	-	-
			JA2-M1WP	R100	R216, <b>R95</b>	JA2.17	-	-
			JA2-TIMIN0	R95	R216, <b>R100</b>	JA2.21	-	-
P86	N3	P86	<b>PDC-PIXD1</b>	<b>R308</b>	<b>R34, R102, R94</b>	<b>J19.17</b>	-	-
			JA6-RXDc	R34	R308, <b>R102, R94</b>	JA6.12	-	-
			JA2-M1WN	R102	R308, <b>R34, R94</b>	JA2.18	-	-
			JA2-TIMIN1	R94	R308, <b>R34, R102</b>	JA2.22	-	-
P81	L9	P81	<b>OnTFT-R5</b>	<b>R321</b>	<b>R107</b>	<b>ONTFT1.5</b>	-	-
			JA2-M1UN	R107	R321	<b>ONTFT1.10</b>	-	-
PC7	N9	PC7	<b>OnTFT-G6</b>	<b>J11 (1-2pin short)</b>	<b>R275, R40</b>	<b>ONTFT1.13</b>	-	-
			EMU-UB	J11 (2-3pin short)	<b>R275, R40</b>	<b>ONTFT1.19</b>	-	-
			DSW-UB			E1.10	-	-
			JA2-M1TRDCLK	R275	J11 (open), <b>R40</b>	JA2.26	-	-
			JA6-TXDc	R40	J11 (open), <b>R275</b>	JA6.9	-	-
PC4	P11	PC4	<b>OnTFT-R7</b>	<b>R302, R296</b>	<b>R301, R90</b>	<b>ONTFT1.7</b>	-	-
			JA3-A20	R301, <b>R296</b>	R302, <b>R90</b>	JA3.41	-	-
			JA2-M1POE	R90, <b>R296</b>	R302, <b>R301</b>	JA2.24	-	-
PC1	N14	PC1	<b>JA3-A17</b>	<b>R32</b>	<b>R31</b>	<b>JA3.38</b>	-	-
			JA6-M1TOGGLE	R31	R32	JA6.13	-	-

### 6.15 PDC Configuration

Table 6-24 and Table 6-25 below details the function of the option links associated with PDC Configuration.

**Table 6-24: PDC Configuration Option Links(1)**

Signal name	MCU		MCU Peripheral Selection			Destination Selection		
	Pin	Port	Signal	Fit	DNF	Interface /Function	Fit	DNF
P17	P2	P17	<b>PMOD1-I00</b>	<b>R280</b>	<b>R44, R281, R277</b>	<b>PMOD1.7</b>	-	-
			JA6-TXD <sub>b</sub>	R44	R280, <b>R281, R277</b>	JA6.8	-	-
			PDC-PIXD3	R281	R280, <b>R44, R277</b>	J19.15	-	-
			SSI-TXD	R277	R280, <b>R44, R281</b>	J18.12	-	-
P15	J7	P15	<b>ET-INT<sub>n</sub></b>	<b>R336</b>	<b>R118, R119</b>	<b>U13.21</b>	-	-
			JA2-IRQ <sub>b</sub> -M1HSIN1	R118	R336, <b>R119</b>	JA2.9	-	-
			PDC-PIXD0	R119	R336, <b>R118</b>	J19.18	-	-

**Table 6-25: PDC Configuration Option Links(2)**

Signal name	MCU		MCU Peripheral Selection			Destination Selection		
	Pin	Port	Signal	Fit	DNF	Interface /Function	Fit	DNF
P25	M3	P25	PDC-HSYNC	R317	R103, R97, R45	J19.10	-	-
			JA2-M1VN	R103	R317, R97, R45	JA2.16	-	-
			JA2-TIMOUT1	R97	R317, R103, R45	JA2.20	-	-
			JA6-RXDb	R45	R317, R103, R97	JA6.7	-	-
P24	L4	P24	PDC-PIXCLK	R304, R99	R104, R303, R98	J19.8	-	-
			JA2-M1VP	R104, R99	R304, R303, R98	JA2.15	-	-
			JA6-SCKb	R303, R99	R304, R104, R98	JA6.10	-	-
			JA2-TIMOUT0	R98, R99	R304, R104, R303	JA2.19	-	-
P23	M2	P23	PDC-PIXD7	R290, R283	R288, R287	J19.11	-	-
			SSI-SCK	R288, R283	R290, R287	J18.9	-	-
			JA6-DACK	R287, R283	R290, R288	JA6.2	-	-
P22	N1	P22	USB0-OVRCURB	R282, R60	R64, R286, R68, R59	U9.3	J10 (1-2pin short) or R25	J10 (2-3pin short) and R26
			PDC-PIXD6	R64, R60	R282, R286, R68, R59	J19.12	-	-
			SSI-AUDIOCLK	R286, R60	R282, R64, R68, R59	J18.5	-	-
			JA2-M1UP	R68, R60	R282, R64, R286, R59	JA2.13	-	-
			JA6-DREQ	R59, R60	R282, R64, R286, R68	JA6.1	-	-
P21	R1	P21	E2P-SCL	R75, R79	R78	U3.6	-	-
			JA1-SCL			JA1.26	-	-
			PDC-PIXD5	R78	R75, R79	J19.13	-	-
P20	P3	P20	E2P-SDA	R72, R73	R69, R70	U3.5	-	-
			JA1-SDA			JA1.25	-	-
			PDC-PIXD4	R69	R72, R73, R70	J19.14	-	-
			JA2-M1ENC	R70	R72, R73, R69	JA2.23	R91	R86
P33	H4	P33	CAN1RX	R46, R48	R43, R49	U4.4	-	-
			PDC-PCKO	R43, R48	R46, R49	J19.5	-	-
			JA5-CAN1RX	R49, R48	R46, R43	JA5.6	-	-
P32	H5	P32	CAN1TX	R300	R87, R47, R295	U16.3	-	-
			JA2-IRQc_M1HSIN2	R87	R300, R47, R295	JA2.23	R86	R91
			JA5-CAN1TX	R47	R300, R87, R295	JA5.5	-	-
			PDC-VSYNC	R295	R300, R87, R47	J19.9	-	-
P87	R2	P87	PDC-PIXD2	-	-	J19.16 T4	R12	-
P86	N3	P86	PDC-PIXD1	R308	R34, R102, R94	J19.17	-	-
			JA6-RXDc	R34	R308, R102, R94	JA6.12	-	-
			JA2-M1WN	R102	R308, R34, R94	JA2.18	-	-
			JA2-TIMIN1	R94	R308, R34, R102	JA2.22	-	-
PDC-RESn	M11	PL5	PDC-RESn	R138	R137	J19.6	R175	-
PM2	K11	PM2	SDHI-D0	R134	R133	SDHI1.7	-	-
			PDC-SSDA	R133	R134	J19.19	R176	-
PM1	F11	PM1	SDHI-CMD	R136	R135	SDHI1.2	-	-
			PDC-SSCL	R135	R136	J19.20	R419	-
RESn	G7	-	EMU-RESn	-	-	E1.13	-	-
			SW-RESn	-	-	RES1(Switch)	-	-
			JA2-RESn	-	-	JA2.1	-	-
			PDC-RESn	R137	R138	J19.6	R175	-
			OnTFT-RESn	R128	R129	ONTFT2.6	R320	-

## 6.16 PMOD1 Configuration

Table 6-26 below details the function of the option links associated with PMOD1 Configuration.

**Table 6-26: PMOD1 Configuration Option Links**

Signal name	MCU		MCU Peripheral Selection			Destination Selection		
	Pin	Port	Signal	Fit	DNF	Interface /Function	Fit	DNF
PMOD1-IO1	D6	P02	PMOD1-IO1	-	-	PMOD1.8	-	-
P17	P2	P17	PMOD1-IO0	R280	R44, R281, R277	PMOD1.7	-	-
			JA6-TXDb	R44	R280, R281, R277	JA6.8	-	-
			PDC-PIXD3	R281	R280, R44, R277	J19.15	-	-
			SSI-TXD	R277	R280, R44, R281	J18.12	-	-
PMOD1-CS	L1	PH3	PMOD1-CS	-	-	PMOD1.1	-	-
PMOD1-MOSI	J6	PH2	PMOD1-MOSI	-	-	PMOD1.2	-	-
PMOD1-MISO	K6	PH1	PMOD1-MISO	-	-	PMOD1.3	-	-
PMOD1-SCK	N2	PH0	PMOD1-SCK	R246	-	PMOD1.4	-	-
PMOD1-IO2	P1	PK7	PMOD1-IO2	-	-	PMOD1.9	-	-
PMOD1-IO3	H11	PL0	PMOD1-IO3	-	-	PMOD1.10	-	-

## 6.17 PMOD2 Configuration

Table 6-27 below details the function of the option links associated with PMOD2 Configuration.

**Table 6-27: PMOD2 Configuration Option Links**

Signal name	MCU		MCU Peripheral Selection			Destination Selection		
	Pin	Port	Signal	Fit	DNF	Interface /Function	Fit	DNF
P00	E3	P00	QSPI-IO2	R324	R323	U11.3	-	-
			PMOD2-IO1	R323	R324	PMOD2.8	-	-
PMOD2-IO3	D2	P47	PMOD2-IO3	-	-	PMOD2.10	-	-
PMOD2-IO0	B4	P46	PMOD2-IO0	-	-	PMOD2.7	-	-
P52	L8	P52	JA3-RDn	R149	R139	JA3.25	-	-
			PMOD2-MISO	R139	R149	PMOD2.3	-	-
P51	M8	P51	JA3-WRHn	R148, R131	R132	JA3.47	R157	R359
			PMOD2-SCK	R132, R131	R148	PMOD2.4	-	-
P50	K8	P50	JA3-WRn	R140	R352, R353	JA3.26	R150	R366
			JA3-WRLn	R352	R140, R353	JA3.48	R156	R360
			PMOD2-MOSI	R353	R140, R352	PMOD2.2	-	-
PJ5	G5	PJ5	QSPI-IO1	R298	R82, R297	U11.2	-	-
			PMOD2-CS	R82	R298, R297	PMOD2.1	-	-
			SSI-RXD	R297	R298, R82	J18.10	-	-
PMOD2-IO2	E9	PQ3	PMOD2-IO2	-	-	PMOD2.9	-	-

## 6.18 QSPI Configuration

Table 6-28 below details the function of the option links associated with QSPI Configuration.

**Table 6-28: QSPI Configuration Option Links**

Signal name	MCU		MCU Peripheral Selection			Destination Selection		
	Pin	Port	Signal	Fit	DNF	Interface /Function	Fit	DNF
QSPI-IO3	D5	P01	QSPI-IO3	-	-	U11.7	-	-
P00	E3	P00	QSPI-IO2	R324	R323	U11.3	-	-
			PMOD2-IO1	R323	R324	PMOD2.8	-	-
PJ5	G5	PJ5	QSPI-IO1	R298	R82, R297	U11.2	-	-
			PMOD2-CS	R82	R298, R297	PMOD2.1	-	-
			SSI-RXD	R297	R298, R82	J18.10	-	-
QSPI-IO0	H7	PJ3	QSPI-IO0	-	-	U11.5	-	-
QSPI-CS	J11	PN5	QSPI-CS	-	-	U11.1	-	-
QSPI-CLK	L12	PN4	QSPI-CLK	R22	-	U11.6	-	-

## 6.19 RSPI Configuration

Table 6-29 below details the function of the option links associated with RSPI Configuration.

**Table 6-29: RSPI Configuration Option Links**

Signal name	MCU		MCU Peripheral Selection			Destination Selection		
	Pin	Port	Signal	Fit	DNF	Interface /Function	Fit	DNF
RSPI-CS	J9	PK3	RSPI-CS	-	-	U10.1	-	-
RSPI-MISO	N11	PK2	RSPI-MISO	-	-	U10.2	-	-
RSPI-MOSI	K9	PK1	RSPI-MOSI	-	-	U10.5	-	-
RSPI-CLK	M10	PK0	RSPI-CLK	R21	-	U10.6	-	-

## 6.20 SDHI Configuration

Table 6-30 below details the function of the option links associated with SDHI Configuration.

**Table 6-30: SDHI Configuration Option Links**

Signal name	MCU		MCU Peripheral Selection			Destination Selection		
	Pin	Port	Signal	Fit	DNF	Interface /Function	Fit	DNF
P41	A4	P41	SDHI-POWFLT	R120	R121	U6.5	-	-
			JA1-ADC1	R121	R120	JA1.10	-	-
SDHI-PE	K3	PH4	SDHI-PE	-	-	U6.4	-	-
SDHI-WP	M13	PM7	SDHI-WP	-	-	SDHI1.12	-	-
SDHI-CD	N13	PM6	SDHI-CD	-	-	SDHI1.10	-	-
SDHI-D3	R15	PM5	SDHI-D3	-	-	SDHI1.1	-	-
SDHI-D2	P14	PM4	SDHI-D2	-	-	SDHI1.9	-	-
SDHI-D1	P15	PM3	SDHI-D1	-	-	SDHI1.8	-	-
PM2	K11	PM2	SDHI-D0	R134	R133	SDHI1.7	-	-
			PDC-SSDA	R133	R134	J19.19	R176	-
PM1	F11	PM1	SDHI-CMD	R136	R135	SDHI1.2	-	-
			PDC-SSCL	R135	R136	J19.20	R419	-
SDHI-CLK	G11	PM0	SDHI-CLK	R23	-	SDHI1.5	-	-

### 6.21 Serial & USB to Serial Configuration

Table 6-31 below details the function of the option links associated with Serial & USB to Serial Configuration.

**Table 6-31: Serial & USB to Serial Configuration Option Links**

Signal name	MCU		MCU Peripheral Selection			Destination Selection		
	Pin	Port	Signal	Fit	DNF	Interface /Function	Fit	DNF
P03	D3	P03	SERIAL-CTS	R105	R106	U15.2	-	-
			JA1-DAC0	R106	R105	JA1.13	-	-
P17	P2	P17	PMOD1-IO0	R280	R44, R281, R277	PMOD1.7	-	-
			JA6-TXDb	R44	R280, R281, R277	JA6.8	-	-
			PDC-PIXD3	R281	R280, R44, R277	J19.15	-	-
			SSI-TXD	R277	R280, R44, R281	J18.12	-	-
P12	R4	P12	JA6-M1UIN	-	-	JA6.14	-	-
P25	M3	P25	PDC-HSYNC	R317	R103, R97, R45	J19.10	-	-
			JA2-M1VN	R103	R317, R97, R45	JA2.16	-	-
			JA2-TIMOUT1	R97	R317, R103, R45	JA2.20	-	-
			JA6-RXDb	R45	R317, R103, R97	JA6.7	-	-
P24	L4	P24	PDC-PIXCLK	R304, R99	R104, R303, R98	J19.8	-	-
			JA2-M1VP	R104, R99	R304, R303, R98	JA2.15	-	-
			JA6-SCKb	R303, R99	R304, R104, R98	JA6.10	-	-
			JA2-TIMOUT0	R98, R99	R304, R104, R303	JA2.19	-	-
P31	J4	P31	ET-MDC	R218	R3	U13.12	-	-
			JA2-CTSaRTSa	R3	R218	JA2.12	-	-
P43	E4	P43	SERIAL-RTS	R108	R109	U17.2	-	-
			JA1-ADC3	R109	R108	JA1.12	-	-
P86	N3	P86	PDC-PIXD1	R308	R34, R102, R94	J19.17	-	-
			JA6-RXDc	R34	R308, R102, R94	JA6.12	-	-
			JA2-M1WN	R102	R308, R34, R94	JA2.18	-	-
			JA2-TIMIN1	R94	R308, R34, R102	JA2.22	-	-
P83	M9	P83	OnTFT-G5	R271, R36	R35	ONTFT1.18	-	-
			JA6-SCKc	R35, R36	R271	JA6.11	-	-
PC7	N9	PC7	OnTFT-G6	J11 (1-2pin short)	R275, R40	ONTFT1.13 ONTFT1.19	-	-
			EMU-UB	J11 (2-3pin short)	R275, R40	E1.10	-	-
			DSW-UB	J11 (2-3pin short)	R275, R40	SW4.2	-	-
			JA2-M1TRDCLK	R275	J11 (open), R40	JA2.26	-	-
			JA6-TXDc	R40	J11 (open), R275	JA6.9	-	-
PF2	J2	PF2	EMU-TDI RXD	R338	R339, R123	E1.11	-	-
			SERIAL-RXD	R339	R338, R123	U15.3	-	R50, R337
			JA2-RXDa	R123	R338, R339	JA2.8	-	-
PF1	L3	PF1	EMU-TCK	R385, R11	R164	E1.1	-	-
			JA2-SCKa	R164, R11	R385	JA2.10	-	-
PF0	K5	PF0	EMU-TDO TXD	R344	R343, R126	E1.5	-	-
			SERIAL-TXD	R343	R344, R126	U17.3	-	R51, R52
			JA2-TXDa	R126	R344, R343	JA2.6	-	-
PL2	P12	PL2	SERIAL-TXD	R52	R51, R343	U17.3	-	-
PL1	J10	PL1	SERIAL-RXD	R377	R50, R339	U15.3	-	-

### 6.22 SSIE Configuration

Table 6-32 below details the function of the option links associated with SSIE Configuration.

**Table 6-32: SSIE Configuration Option Links**

Signal name	MCU		MCU Peripheral Selection			Destination Selection		
	Pin	Port	Signal	Fit	DNF	Interface /Function	Fit	DNF
P17	P2	P17	PMOD1-IO0	R280	R44, R281, R277	PMOD1.7	-	-
			JA6-TXDb	R44	R280, R281, R277	JA6.8	-	-
			PDC-PIXD3	R281	R280, R44, R277	J19.15	-	-
			SSI-TXD	R277	R280, R44, R281	J18.12	-	-
P23	M2	P23	PDC-PIXD7	R290, R283	R288, R287	J19.11	-	-
			SSI-SCK	R288, R283	R290, R287	J18.9	-	-
			JA6-DACK	R287, R283	R290, R288	JA6.2	-	-
P22	N1	P22	USB0-OVRCURB	R282, R60	R64, R286, R68, R59	U9.3	J10 (1-2pin short) or R25	J10 (2-3pin short) and R26
			PDC-PIXD6	R64, R60	R282, R286, R68, R59	J19.12	-	-
			SSI-AUDIOCLK	R286, R60	R282, R64, R68, R59	J18.5	-	-
			JA2-M1UP	R68, R60	R282, R64, R286, R59	JA2.13	-	-
			JA6-DREQ	R59, R60	R282, R64, R286, R68	JA6.1	-	-
PF5	G6	PF5	SSI-LRCK	R351	R143	J18.11	-	-
			JA3-WAIT	R143	R351	JA3.45	R154	R15
PJ5	G5	PJ5	QSPI-IO1	R298	R82, R297	U11.2	-	-
			PMOD2-CS	R82	R298, R297	PMOD2.1	-	-
			SSI-RXD	R297	R298, R82	J18.10	-	-

### 6.23 USB Configuration

Table 6-33 below details the function of the option links associated with the USB Configuration.

**Table 6-33: USB Configuration Option Links**

Signal name	MCU		MCU Peripheral Selection			Destination Selection		
	Pin	Port	Signal	Fit	DNF	Interface /Function	Fit	DNF
P16	R3	P16	USB0-VBUS	J7(1-2 short), J9(1-2 short) or R7	R115	USB0_2.1	J8(1-2 short), R2	-
			USB0-VBUSEN	J7(2-3 short)	R115	U7.4	-	-
			JA2-M1UD	R115	J7(Open)	JA2.11	-	-
P14	P4	P14	OnTFT-CLK	R294, R299	R74, J12(open)	ONTFT1.30	-	-
			JA2-M1TRCCLK	R74, R299	R294, J12(open)	JA2.25	-	-
			USB0-OVRCURA	J12(short) , R299	R294, R74, R282	U9.3	J10 (2-3pin short) or R26	J10 (1-2pin open) and R25
P22	N1	P22	USB0-OVRCURB	R282, R60	R64, R286, R68, R59	U9.3	J10 (1-2pin short) or R25	J10 (2-3pin short) and R26
			PDC-PIXD6	R64, R60	R282, R286, R68, R59	J19.12	-	-
			SSI-AUDIOCLK	R286, R60	R282, R64, R68, R59	J18.5	-	-
			JA2-M1UP	R68, R60	R282, R64, R286, R59	JA2.13	-	-
			JA6-DREQ	R59, R60	R282, R64, R286, R68	JA6.1	-	-
P35	H3	P35	JP-UPSEL	-	-	J15.2	-	-
			JA2-NMIn	R127	-	JA2.3	-	-
USB0-DP	R6	-	USB0-DP	-	-	USB0_1.3	-	-
						USB0_2.3	-	-
USB0-DM	R5	-	USB0-DM	-	-	USB0_1.2	-	-
						USB0_2.2	-	-

Table 6-34 below details the function of the jumpers associated with the USB Configuration.

**Table 6-34: USB Configuration Jumper Option Links**

Reference	Jumper Position	Configuration	Related Links
J9(DNF) *1	Shorted Pin1-2	Self-powered	J8, R7
	Shorted Pin2-3	Bus-powered	J8, J17, R7
	All open	Self-powered by R7	J8
J8	Shorted Pin1-2	USB0 Function mode	J9, R7
	Shorted Pin2-3	USB0 Host mode	-
	All open	DO NOT SET.	-

\*1: If J9 is fitted, remove R7.

When using USB in function mode, be sure to set J8 to 1-2 Short. Also, do not plug in both USB0\_1 and USB0\_2 cables at the same time.

## 6.24 Unused Terminal Configuration

Table 6-35 below details the function of the option links associated with the Unused Terminal Configuration.

**Table 6-35: Unused Terminal Configuration Option Links**

Signal name	MCU		MCU Peripheral Selection			Destination Selection		
	Pin	Port	Signal	Fit	DNF	Interface /Function	Fit	DNF
P60TERM	C10	P60	P60TERM	-	-	J6.1	-	-
P77TERM	L11	P77	P77TERM	-	-	J6.6	-	-
P76TERM	N12	P76	P76TERM	-	-	J6.5	-	-
P75TERM	R13	P75	P75TERM	-	-	J6.4	-	-
P74TERM	R14	P74	P74TERM	-	-	J6.3	-	-
P72TERM	K15	P72	P72TERM	-	-	J6.2	-	-
P92TERM	A5	P92	P92TERM	-	-	J6.7	-	-
PH5TERM	K4	PH5	PH5TERM	-	-	J6.8	-	-
PK6TERM	F7	PK6	PK6TERM	-	-	J6.10	-	-
PK5TERM	F5	PK5	PK5TERM	-	-	J6.9	-	-

## 7. Headers

### 7.1 Application Headers

This RSK+ board is fitted with application headers, which can be used to connect compatible Renesas application devices or as easy access to MCU pins.

Table 7-1 below lists the connections of the application header, JA1.

**Table 7-1: Application Header JA1 Connections**

Application Header JA1					
Pin	Header Name	MCU Pin	Pin	Header Name	MCU Pin
	Circuit Net Name			Circuit Net Name	
1	5V	-	2	0V	-
	JA1-5V			GROUND	
3	3V3	-	4	0V	-
	JA1-3V3			GROUND	
5	AVCC	B2, C2	6	AVSS	B1, C1, A3
	JA1-AVCC			JA1-AVSS	
7	AVREF	A2	8	ADTRG	E5, N5
	JA1-VREFH			JA1-ADTRG	
9	ADC0	D4	10	ADC1	A4
	JA1-ADC0			JA1-ADC1	
11	ADC2	B3	12	ADC3	E4
	JA1-ADC2			JA1-ADC3	
13	DAC0	D3	14	DAC1	C3
	JA1-DAC0			JA1-DAC1	
15	IO_0	A10	16	IO_1	D10
	JA1-IO0			JA1-IO1	
17	IO_2	D14	18	IO_3	F13
	JA1-IO2			JA1-IO3	
19	IO_4	E15	20	IO_5	E14
	JA1-IO4			JA1-IO5	
21	IO_6	F14	22	IO_7	F15
	JA1-IO6			JA1-IO7	
23	IRQd / IRQAEC / M2_HSIN0	E5 / NC / NC	24	IIC_EX	NC
	JA1-IRQd			NC	
25	IIC_SDA	P3	26	IIC_SCL	R1
	JA1-SDA			JA1-SCL	



Table 7-2 below lists the connections of the application header, JA2.

**Table 7-2: Application Header JA2 Connections**

Application Header JA2					
Pin	Header Name	MCU Pin	Pin	Header Name	MCU Pin
	Circuit Net Name			Circuit Net Name	
1	RESET	G7	2	EXTAL	J1
	JA2-RESn			JA2-EXTAL	
3	NMI	H3	4	Vss1	-
	JA2-NMIIn			GROUND	
5	WDT_OVF	NC	6	SClTX	K5
	NC			JA2-TXDa	
7	IRQa / WKUP / M1_H SIN0	H2	8	SClRX	J2
	JA2-IRQa_M1HSIN0			JA2-RXDa	
9	IRQb / M1_H SIN1	J7	10	SClCK	L3
	JA2-IRQb_M1HSIN1			JA2-SCKa	
11	M1_UD	R3	12	CTSaRTSa	J4
	JA2-M1UD			JA2-CTSaRTSa	
13	M1_UP	N1	14	M1_UN	L9
	JA2-M1UP			JA2-M1UN	
15	M1_VP	L4	16	M1_VN	M3
	JA2-M1VP			JA2-M1VN	
17	M1_WP	J5	18	M1_WN	N3
	JA2-M1WP			JA2-M1WN	
19	TimerOut0	L4	20	TimerOut1	M3
	JA2-TIMOUT0			JA2-TIMOUT1	
21	TimerIn0	J5	22	TimerIn1	N3
	JA2-TIMIN0			JA2-TIMIN1	
23	IRQc / M1_EncZ / M1_H SIN2	H5 / P3 / H5	24	M1_POE	P11
	JA2-23PIN			JA2-M1POE	
25	M1_TRCCLK	P4	26	M1_TRDCLK	N9
	JA2-M1TRCCLK			JA2-M1TRDCLK	

Table 7-3 below lists the connections of the BUS application header, JA3.

**Table 7-3: Application Header JA3 Connections**

Application Header JA3 (Bus)					
Pin	Header Name Circuit Net Name	MCU Pin	Pin	Header Name Circuit Net Name	MCU Pin
1	A0 JA3-A0	F12	2	A1 JA3-A1	G12
3	A2 JA3-A2	G13	4	A3 JA3-A3	G14
5	A4 JA3-A4	G15	6	A5 JA3-A5	H15
7	A6 JA3-A6	H14	8	A7 JA3-A7	J15
9	A8 JA3-A8	J14	10	A9 JA3-A9	J12
11	A10 JA3-A10	L14	12	A11 JA3-A11	K14
13	A12 JA3-A12	L15	14	A13 JA3-A13	K13
15	A14 JA3-A14	M15	16	A15 JA3-A15	N15
17	D0 JA3-D0	A6	18	D1 JA3-D1	C7
19	D2 JA3-D2	A7	20	D3 JA3-D3	A9
21	D4 JA3-D4	B9	22	D5 JA3-D5	D9
23	D6 JA3-D6	B10	24	D7 JA3-D7	A11
25	RDn JA3-RDn	L8	26	WR / SDWE JA3-26PIN	K8 / C11
27	CSa JA3-CSa	H10	28	CSb *1 JA3-CSb	A12
29	D8 JA3-D8	D11	30	D9 JA3-D9	A14
31	D10 JA3-D10	B13	32	D11 JA3-D11	D12
33	D12 JA3-D12	B14	34	D13 JA3-D13	C13
35	D14 JA3-D14	E13	36	D15 JA3-D15	B15
37	A16 JA3-A16	M14	38	A17 JA3-A17	N14
39	A18 JA3-A18	P13	40	A19 JA3-A19	R11
41	A20 JA3-A20	P11	42	A21 JA3-A21	R10
43	A22 JA3-A22	R9	44	SDCLK *2 JA3-44PIN	A15 / J8
45	CSc / Wait JA3-45PIN	M1 / G6	46	ALE / SDCKE JA3-46PIN	K7 / C14
47	HWRn / DQMH JA3-47PIN	M8 / D15	48	LWRn / DQML JA3-48PIN	K8 / C15
49	CAS JA3-CAS	B12	50	RAS JA3-RAS	A13

\*1: The chip select signal assigned on this board can also be used as a SDRAM chip select.

\*2: This board can also output BCLK signal to JA3 header.

Table 7-4 below lists the connections of the application header, JA5.

**Table 7-4: Application Header JA5 Connections**

Application Header JA5					
Pin	Header Name	MCU Pin	Pin	Header Name	MCU Pin
	Circuit Net Name			Circuit Net Name	
1	ADC4	B13	2	ADC5	D12
	JA5-ADC4			JA5-ADC5	
3	ADC6	B14	4	ADC7	C13
	JA5-ADC6			JA5-ADC7	
5	CAN1TX	H5	6	CAN1RX	H4
	JA5-CAN1TX			JA5-CAN1RX	
7	CAN2TX	NC	8	CAN2RX	NC
	NC			NC	
9	IRQe / M2_EncZ / M2HSIN1	NC / NC / NC	10	IRQf / M2_HSIN2	NC / NC
	NC			NC	
11	M2_UD	NC	12	M2_Uin	NC
	NC			NC	
13	M2_Vin	NC	14	M2_Win	NC
	NC			NC	
15	M2_Toggle	NC	16	M2_POE	NC
	NC			NC	
17	M2_TRCCLK	NC	18	M2_TRDCLK	NC
	NC			NC	
19	M2_UP	NC	20	M2_Un	NC
	NC			NC	
21	M2_VP	NC	22	M2_Vn	NC
	NC			NC	
23	M2_WP	NC	24	M2_Wn	NC
	NC			NC	

Table 7-5 below lists the connections of the application header, JA6.

**Table 7-5: Application Header JA6 Connections**

Application Header JA6					
Pin	Header Name	MCU Pin	Pin	Header Name	MCU Pin
	Circuit Net Name			Circuit Net Name	
1	DREQ	N1	2	DACK	M2
	JA6-DREQ			JA6-DACK	
3	TEND	NC	4	STBYn	NC
	NC			NC	
5	RS232TX	NC	6	RS232RX	NC
	JA6-RS232TX			JA6-RS232RX	
7	SClBbRX	M3	8	SClBbTX	P2
	JA6-RXDb			JA6-TXDb	
9	SClCtTX	N9	10	SClCtCK	L4
	JA6-TXDc			JA6-SCKb	
11	SClCtCK	M9	12	SClCtRX	N3
	JA6-SCKc			JA6-RXDc	
13	M1_Toggle	N14	14	M1_Uin	R4
	JA6-M1TOGGLE			JA6-M1UIN	
15	M1_Vin	P8	16	M1_Win	K7
	JA6-M1VIN			JA6-M1WIN	
17	EXT_USB_VBUS	NC	18	Reserved	NC
	NC			NC	
19	EXT_USB_BATT	NC	20	Reserved	NC
	NC			NC	
21	EXT_USB_CHG	NC	22	Reserved	NC
	NC			NC	
23	Unregulated_VCC	-	24	Vss	-
	Unregulated_VCC			GROUND	

## 8. Code Development

### 8.1 Overview

For all code debugging using Renesas software tools, the RSK+ board must be connected to a PC via an E1/E20/E2 Lite debugger. An E1/E2 Lite debugger is supplied with this RSK+ product.

For further information regarding the debugging capabilities of the E1/E20/E2 Lite debuggers, refer to E1/E20 Emulator, E2 Emulator Lite Additional Document for User's Manual (R20UT0399EJ).

### 8.2 Compiler Restrictions

The compiler supplied with this RSK+ is fully functional for a period of 60 days from first use. After the first 60 days of use have expired, the compiler will default to a maximum of 128k code and data. To use the compiler with programs greater than this size you need to purchase the full tools from your distributor.

The protection software for the compiler will detect changes to the system clock. Changes to the system clock back in time may cause the trial period to expire prematurely.

### 8.3 Mode Support

The MCU supports Single Chip and Boot Modes (SCI and USB and FINE), which are configured on the RSK+ board. Details of the modifications required can be found in §6.2. All other MCU operating modes are configured within the MCU's registers, which are listed in the RX72N Group User's Manual: Hardware.

Only ever change the MCU operating mode whilst the RSK+ is in reset, or turned off; otherwise the MCU may become damaged as a result.

### 8.4 Debugging Support

The E1 Emulator or E2 Emulator Lite (as supplied with this RSK+) supports break points, event points (including mid-execution insertion) and basic trace functionality. It is limited to a maximum of 8 on-chip event points, 256 software breaks and 256 branch/cycle trace. For further details, refer E1/E20 Emulator User's Manual (R20UT0398EJ) or E2 Emulator Lite User's Manual (R20UT3240EJ).

### 8.5 Address Space

For the MCU address space details, refer to the 'Address Space' section of RX72N Group User's Manual: Hardware.

### 8.6 Note of Flash Access Window Setting Register

This register is used to set the write protection flag and start-up area select flag for setting the flash access window start address, flash access window end address, and access window.

Once 0 is written to this bit, the bit can never be restored to 1.

Therefore, the access window and the BTFLG bit will never be set again. If set the TM function will never be disabled, once enabled. Exercise extra caution when handling the FSPR bit.

For details, refer to Section 7.2.9 in the RX72N Group User's Manual: Hardware.

## 9. Additional Information

### Technical Support

For information about the RX72N group microcontrollers refer to the 'RX72N Group User's Manual: Hardware'.

For information about the RX assembly language, refer to the 'RX Family User's Manual: Software'.

### Technical Contact Details

*Please refer to the contact details listed in section 8 of the "Quick Start Guide"*

General information on Renesas microcontrollers can be found on the Renesas website at:

<https://www.renesas.com/>

### Trademarks

All brand or product names used in this manual are trademarks or registered trademarks of their respective companies or organisations.

### Copyright

This document may be, wholly or partially, subject to change without notice. All rights reserved. Duplication of this document, either in whole or part is prohibited without the written permission of Renesas Electronics Europe GmbH.

© 2019 Renesas Electronics Europe GmbH. All rights reserved.

© 2019 Renesas Electronics Corporation. All rights reserved.

<b>REVISION HISTORY</b>	RX72N Group Renesas Starter Kit+ for RX72N User's Manual
-------------------------	---

<b>Rev.</b>	<b>Date</b>	<b>Description</b>	
		<b>Page</b>	<b>Summary</b>
1.00	Nov 30, 2019	—	First Edition issued

---

RX72N Group  
Renesas Starter Kit+ for RX72N User's Manual

Publication Date: Rev.1.00 Nov 30, 2019

Published by: Renesas Electronics Corporation

---



# RX72N Group