

# ISL85413DEMO3Z

User's Manual: Demonstration Board

Industrial Analog and Power

## ISL85413DEMO3Z

Demonstration Board

UG132  
Rev.0.00  
Jul 14, 2017

## 1. Overview

The ISL85413DEMO3Z board uses the [ISL85413](#) in an isolated buck configuration. It replaces the filter inductor with a coupled inductor (or transformer) to produce a primary output and an inverting secondary output. The board is used to demonstrate the performance of the ISL85413 wide  $V_{IN}$  low quiescent current, high efficiency, synchronous buck regulator to produce a positive primary output and a negative isolated secondary output.

The ISL85413 is offered in a 3mmx3mm 8 Ld TDFN package with 1mm maximum height. The converter occupies 3.3cm<sup>2</sup> area.

### 1.1 Key Features

- Wide input voltage range of 3.5V to 40V
- Synchronous operation for high efficiency
- Integrated high-side and low-side NMOS devices
- Internal switching frequency (700kHz)
- Continuous output current up to 150mA (refer to [Figures 10, 12, and 14](#) on page [10](#))
- Internal soft-start
- No compensation required
- Minimal external components required
- Power-good and enable functions available for primary output

### 1.2 Specifications

- This board has been configured and optimized for the following operating conditions:
- $V_{IN} = 9V$  to 40V
- $V_{OUT} = \pm 5V$ , typical
- $I_{MAX\_PR} = -I_{MAX\_SC}$  up to 150mA (at  $V_{OUT} = \pm 5.0V$ ,  $V_{IN} = 24V$ )

### 1.3 Recommended Equipment

The following materials are recommended to perform testing:

- 0V to 50V power supply with at least 1A source current capability
- Resistive loads capable of sinking current up to 1A
- Digital Multimeters (DMMs)
- 100MHz quad-trace oscilloscope

### 1.4 Ordering Information

Part Number	Description
ISL85413DEMO3Z	Demonstration board with Isolated Outputs

## 1.5 Related Literature

- For a full list of related documents, visit our website
  - [ISL85413](#) product page

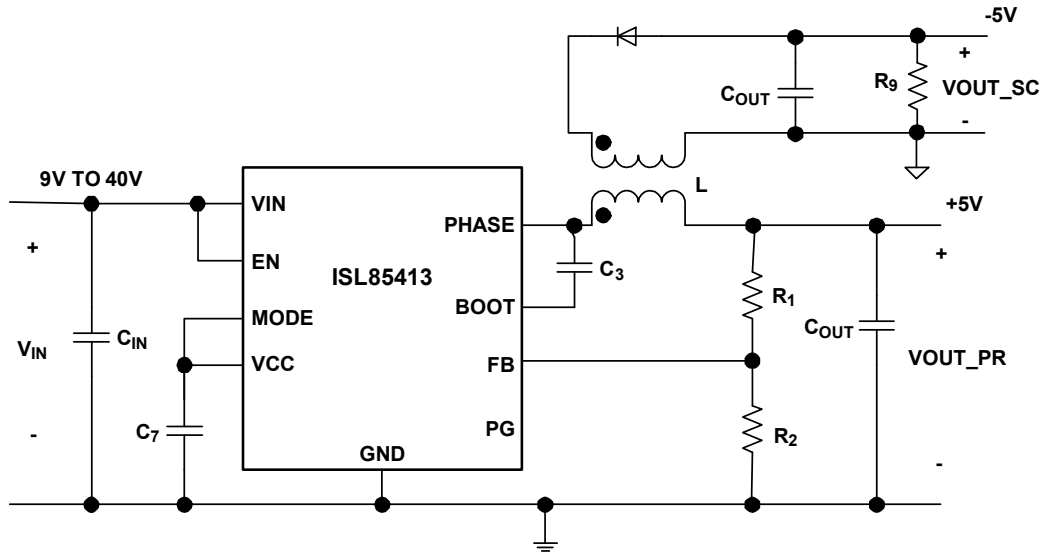

Figure 1. Block Diagram

## 2. Functional Description

### 2.1 Quick Setup Guide

- Ensure that the circuit is correctly connected to the supply and loads prior to applying any power.
- Connect the bias supply to VIN, the plus terminal to VIN (P4) and the negative return to GND (P5).
- Turn on the power supply.
- Without any load applied on the output, verify that the output voltage is 5.0V for V<sub>OUT\_PR</sub> (P7) and between 5.0 to 5.5V for V<sub>OUT\_SC</sub> (P11).

### 2.2 Switch/Jumper Control

The ISL85413DEMO3Z demonstration board contains SW1 for controlling the ON/OFF setting of the converter and JP1 to select between PFM and PWM modes. Turn switch SW1 to the ON position to enable the converter and the OFF position to disable the converter. The jumper is connected between Pins 1 and 2 to select the PWM operation by default for better coupling between the primary and secondary windings. [Table 1](#) summarizes the switch and jumper settings.

**Table 1. Switch and Jumper Setting**

Switch/Jumper	Function
SW1	Enable/Disable
JP1	Select between PFM and PWM mode

### 2.3 Operating Range

The ISL85413DEMO3Z board can be configured to operate at various output voltages. [Table 2](#) shows the operating range for each output voltage. [Table 3 on page 5](#) shows the recommended component selection for each V<sub>OUT</sub>.

**Table 2. Operating Range for Output Voltages**

V <sub>OUT</sub> (V)	V <sub>IN</sub> (V)	I <sub>OUT_PR</sub> = I <sub>OUT_SC</sub> (mA)
±12	18-40	Up to 150mA
±5	9-40	Up to 150mA
±3.3	5-40	Up to 150mA

### 2.4 Evaluating Other Output Voltages

The ISL85413DEMO3Z board output is preset to 5.0V. However, output voltages can be adjusted from 0.6V to 15V. The output voltage programming resistor, R<sub>2</sub>, will depend on the desired output voltage of the regulator and the value of the feedback resistor R<sub>1</sub>, as shown in [\(EQ. 1\)](#).

$$R_2 = R_1 \left( \frac{0.6}{V_{OUT} - 0.6} \right) \quad (\text{EQ. 1})$$

If the output voltage desired is 0.6V, then R<sub>1</sub> is shorted. Please refer to datasheet [ISL85413](#) for further information. [Table 3](#) shows the external component selection for different V<sub>OUT</sub>.

The curves in [Figure 12 on page 10](#) indicate the secondary output voltage regulation versus the load applied in the secondary output, without any load on the primary output for V<sub>OUT</sub> = 5.0V, at different input voltages. The curves in [Figure 13 on page 10](#) indicate the secondary output voltage regulation versus V<sub>IN</sub>, without any load on the primary output for V<sub>OUT</sub> = 5.0V, at different load applied in the secondary output.

### 2.5 Secondary Isolation

The R<sub>10</sub> resistor, which shorts the PGND and the ISOGND on the ISL85413DEMO3Z board, can be replaced with a 2200pF ceramic capacitor (C2012X5R2E222K085AA) to isolate the secondary output from the primary output.

### 3. PCB Layout Guidelines

The ISL85413DEMO3Z PCB layout has been optimized for electrical and thermal performance. Proper layout of the power converter will minimize EMI and noise while ensuring first-pass success of the design.

PCB layout is provided on the Intersil web site. A multilayer printed circuit board with GND plane is recommended. The most critical connections are to tie the PGND pin to the package GND pad and then use vias to directly connect the GND pad to the system GND plane. This connection of the GND pad to the system plane ensures a low impedance path for all return current, as well as an excellent thermal path to dissipate heat.

With this connection made, place the high frequency MLCC input capacitors  $C_1$ , and  $C_2$  near the VIN pin and use vias directly at the capacitor pads to tie the capacitors to the system GND plane. Also, use vias directly at the  $C_5$ , and  $C_6$  output capacitor pads to tie the capacitors to the system GND plane. These measures will minimize the high dv/dt and di/dt loops. Minimize the PHASE connection by placing  $L_1$  very close to the IC. Place a  $1\mu\text{F}$  MLCC near the VCC pin and directly connect its return with a via to the system GND plane. Keep the power components path ( $L_1$ ,  $C_1$ ,  $C_2$ ,  $C_3$ ,  $C_5$ ,  $C_6$ ) separated from the small signal node (FB) by placing the feedback divider close to the FB pin and do not route any feedback components near PHASE or BOOT. Keep the FB trace as short as possible.

Table 3. External Component Selection

V <sub>OUT</sub> (V)	L <sub>1</sub> ( $\mu\text{H}$ )	C <sub>OUT</sub> ( $\mu\text{F}$ )	R <sub>1</sub> (k $\Omega$ )	R <sub>2</sub> (k $\Omega$ )	C <sub>FB</sub> (pF)	R <sub>9</sub> (k $\Omega$ )
$\pm 12$	100	10	90.9	4.75	10	5
$\pm 5$	47	22	90.9	12.4	68	1
$\pm 3.3$	33	22	90.9	20	100	0.825

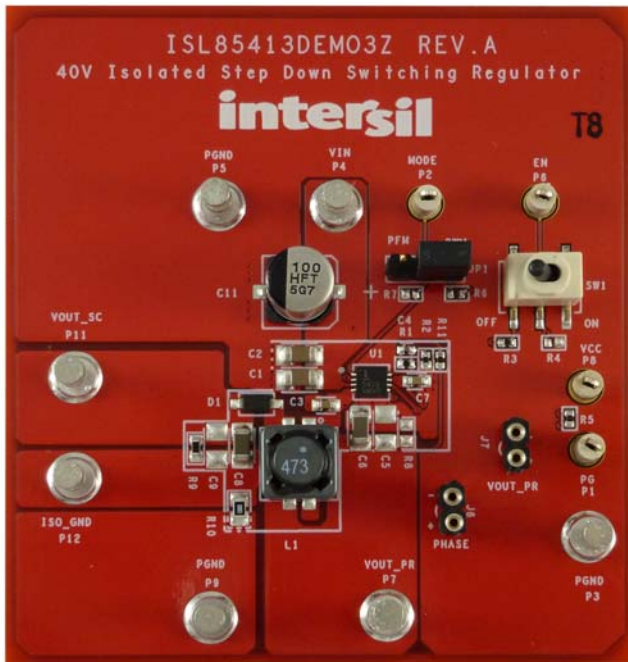

Figure 2. ISL85413DEMO3Z Evaluation Board Top View



Figure 3. ISL85413DEMO3Z Evaluation Board Bottom View

### 3.1 ISL85413DEMO3Z Schematic

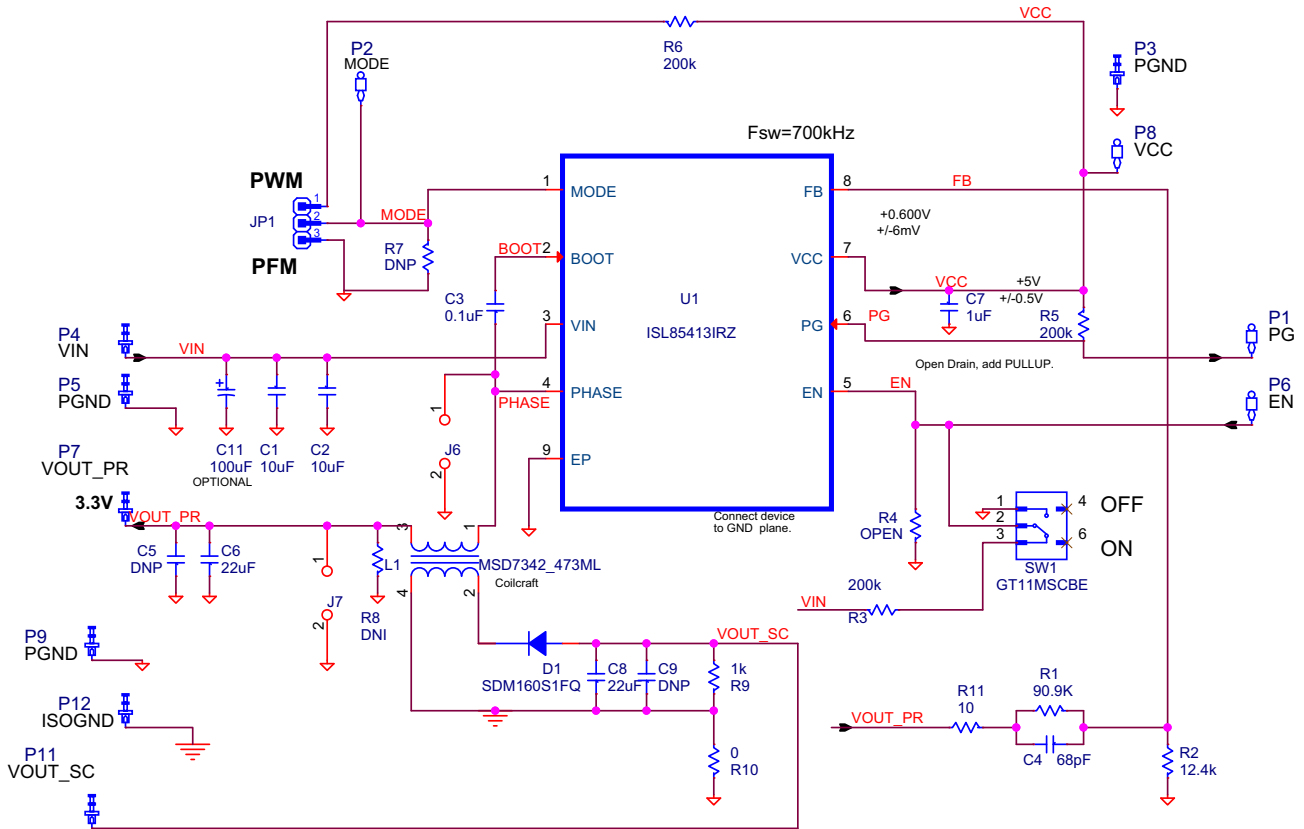

Figure 4. Schematic

### 3.2 ISL85413DEMO3Z Bill of Materials

Manufacturer Part	Qty	Reference Designator	Description	Manufacturer
EEE-FTH101XAP	1	C11 (OPTIONAL)	CAP ALUM 100µF 20% 50V SMD	PANASONIC
C3216X5R1H106K	2	C1, C2	CAP, SMD, 1206, 10µF, 50V, 10%, X5R, ROHS	TDK
06035C104KAT2A	1	C3	CAP, SMD, 0603, 0.1µF, 50V, 10%, X7R, ROHS	AVX
ECJ-0EC1H680J	1	C4	CAP, SMD, 0402, 68pF, 50V, 1%, NP0, ROHS	PANASONIC
ECJ-DV50J226M	2	C6, C8	CAP, SMD, 1206, 22µF, 6.3V, 20%, X5R, ROHS	PANASONIC
GRM188R61C105KA12D	1	C7	CAP, SMD, 0603, 1µF, 16V, 10%, X5R, ROHS	MURATA
1514-2	7	P3-P5, P7, P9, P11, P12	CONN-TURRET, TERMINAL POST, TH, ROHS	KEYSTONE
5002	4	P1, P2, P6, P8	CONN-MINI TEST POINT, VERTICAL, WHITE, ROHS	KEYSTONE
SDM160S1FQ	1	D1	SCHOTTKY DIODE, SMD, 2P, SOD-123F, 60V, 1A, ROHS	DIODES, INC.
ISL85413FRZ	1	U1	IC-300mA BUCK REGULATOR, 12P, DFN, 3x3, ROHS	INTERSIL
MSD7342-473ML	1	L1	COUPLED INDUCTOR, SMD, 4P, 47µH, 10%, 2.5A, ROHS	COILCRAFT
CRCW040290K9FKED	1	R1	RES, SMD, 0402, 90.9k, 1/16W, 1%, TF, ROHS	VISHAY/DALE
CRCW040212K4FKED	1	R2	RES, SMD, 0402, 12.4k, 1/16W, 1%, TF, ROHS	VISHAY/DALE
MCR01MZPF2003	3	R3, R5, R6	RES, SMD, 0402, 200k, 1/16W, 1%, TF, ROHS	ROHM
ERJ-3EKF1001V	1	R9	RES, SMD, 0603, 1k, 1/10W, 1%, TF, ROHS	PANASONIC
ERJ-6GEY0R00V	1	R10	RES, SMD, 0805, 0, 1/8W, 1%, TF, ROHS	PANASONIC
CRCW040210R0FKED	1	R11	RES, SMD, 0402, 10, 1/16W, 1%, TF, ROHS	VISHAY/DALE
GT11MSCBE	1	SW1	SWITCH-TOGGLE, SMD, 6PIN, SPDT, 2POS, ON-NONE-ON, ROHS	ITT INDUSTRIES/ C&K DIVISION
68001-203HLF	1	JP1	CONN-HEADER, 1x3, BRKAWY 1x3, 2.54mm, ST	Amphenol FCI
SPC02SYAN	1	JP1-Pins 1 and 2	CONN-JUMPER, SHORTING, 2PIN, BLACK, GOLD, ROHS	SULLINS
310-43-164-41-001000	2	J6, J7	CCONN-BRD-BRD, TH, 1x2, SKTSTRIP-1x64, 2.54mm, TIN, ROHS	MILL-MAX
	0	C5, C9	CAP, SMD, 1206, DNP-PLACE HOLDER, ROHS	
	0	R4, R7	RESISTOR, SMD, 0402, MF, DNP-PLACE HOLDER	
	0	R8	RESISTOR, SMD, 0603, MF, DNP-PLACE HOLDER	
D810 (212403-012)	1	PLACE ASSY IN BAG	BAG, STATIC, 3x5, ZIP LOC	INTERSIL COMMON STOCK
LABEL-DATE CODE	1	AFFIX TO BACK OF PCB	LABEL-DATE CODE_LINE 1: YRWK/REV#, LINE 2: BOM NAME	INTERSIL
ISL85413DEMO3ZREVAPCB	1		PWB-PCB, ISL85413DEMO3Z, REVA, ROHS	IMAGINEERING INC

### 3.3 ISL85413DEMO3Z Board Layout

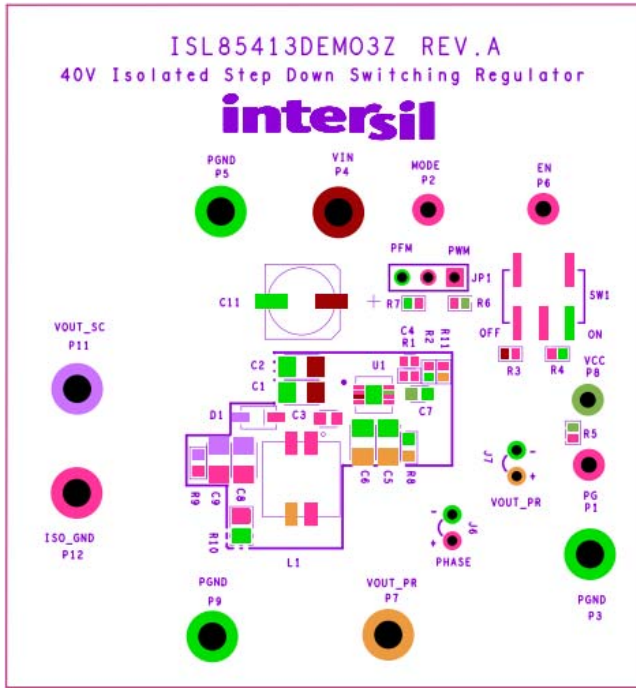

Figure 5. Silkscreen Top

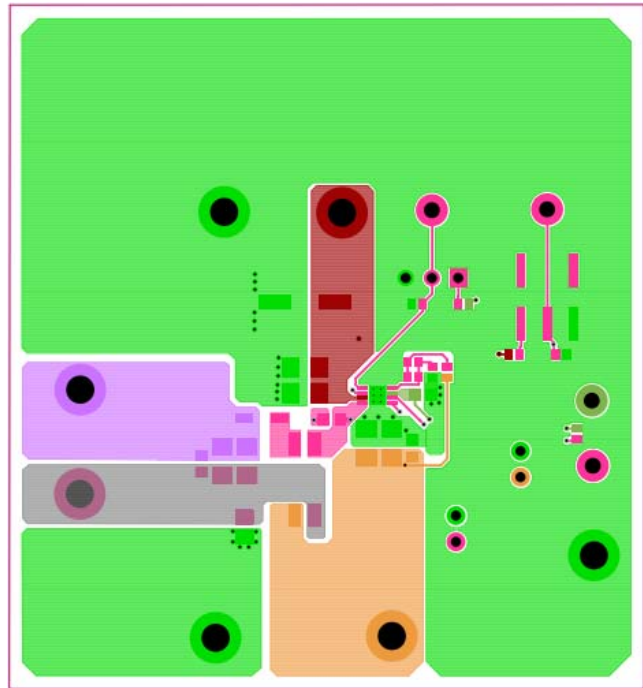

Figure 6. Top Layer

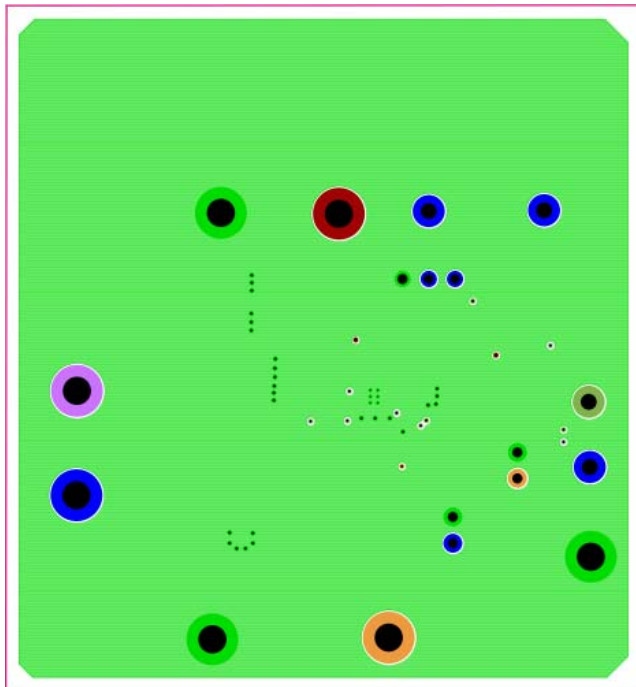

Figure 7. Layer 2 and Layer 3

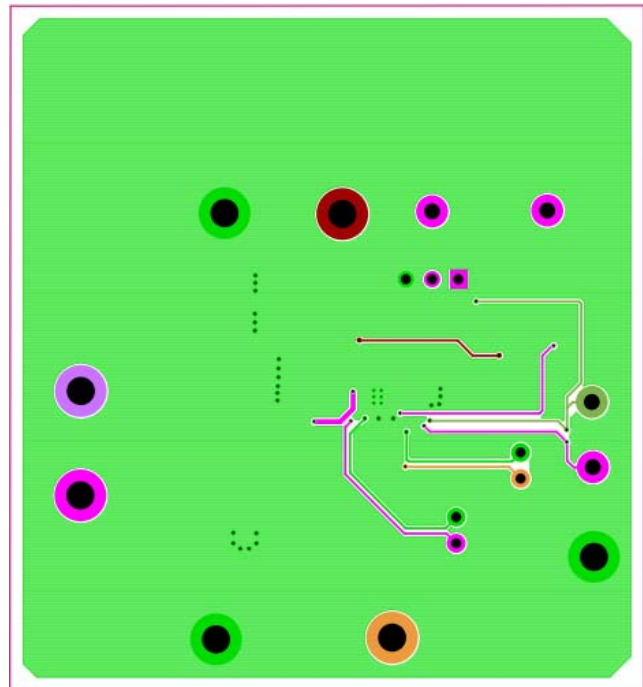

Figure 8. Bottom Layer



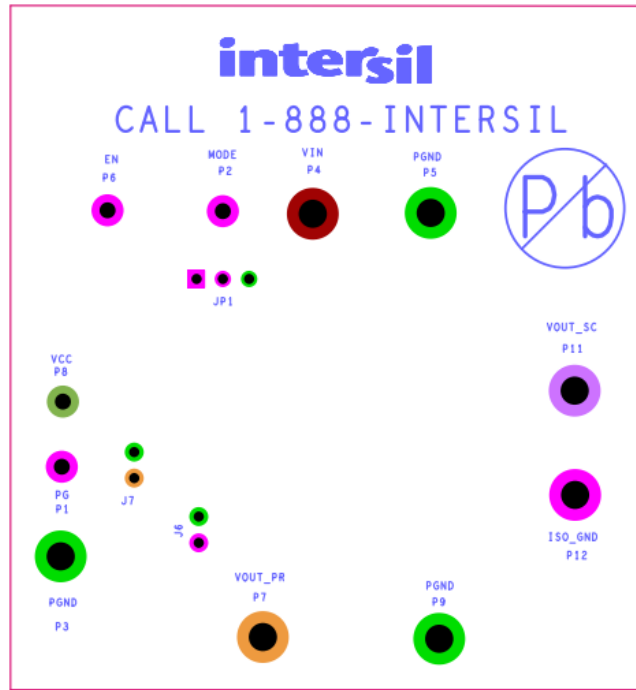

Figure 9. Silkscreen Bottom

### 4. Typical Performance Curves

$f_{SW} = 700\text{kHz}$ ,  $T_A = +25^\circ\text{C}$ .

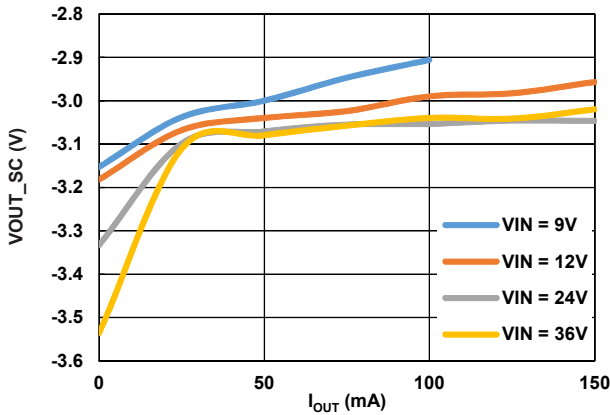

Figure 10.  $V_{OUT\_SC}$  Regulation vs  $I_{OUT}$ ,  $V_{OUT} = \pm 3.3\text{V}$

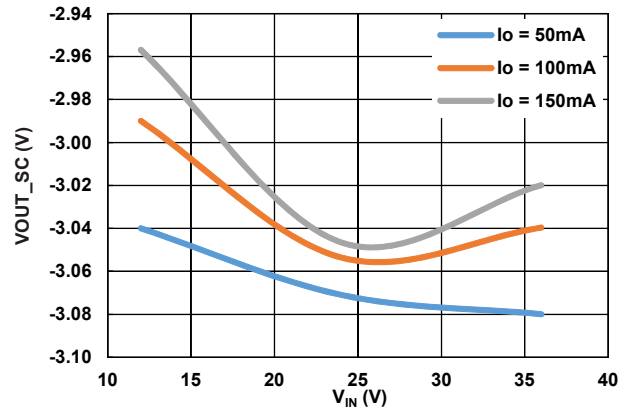

Figure 11.  $V_{OUT\_SC}$  Regulation vs  $V_{IN}$ ,  $V_{OUT} = \pm 3.3\text{V}$

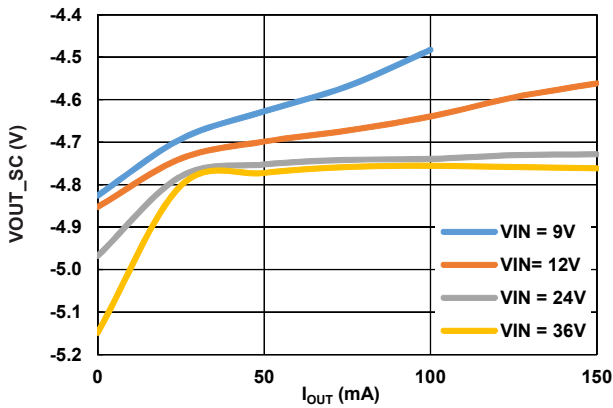

Figure 12.  $V_{OUT\_SC}$  Regulation vs  $I_{OUT}$ ,  $V_{OUT} = \pm 5\text{V}$

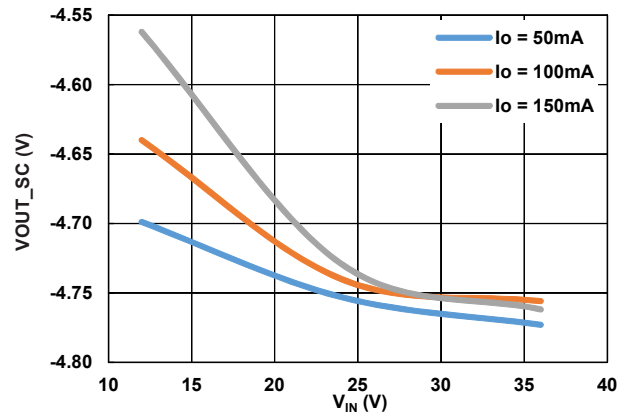

Figure 13.  $V_{OUT\_SC}$  Regulation vs  $V_{IN}$ ,  $V_{OUT} = \pm 5\text{V}$

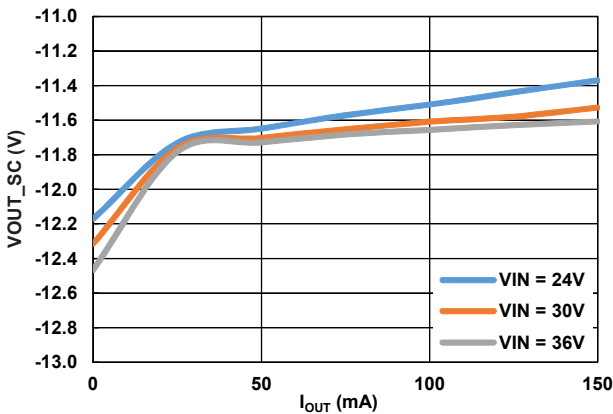

Figure 14.  $V_{OUT\_SC}$  Regulation vs  $I_{OUT}$ ,  $V_{OUT} = \pm 12\text{V}$

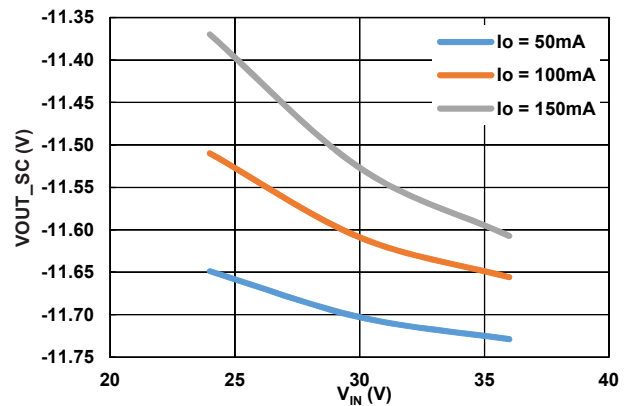

Figure 15.  $V_{OUT\_SC}$  Regulation vs  $V_{IN}$ ,  $V_{OUT} = \pm 12\text{V}$

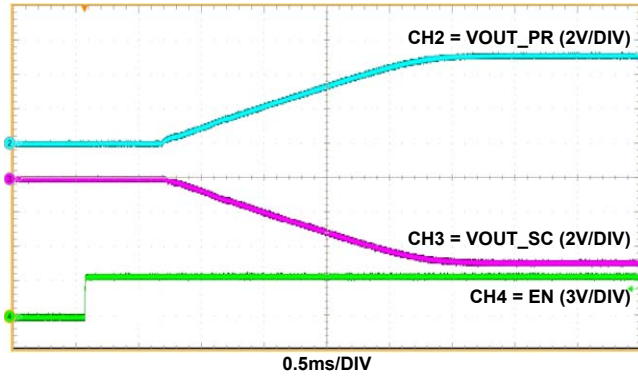

Figure 16. Start-Up by EN ( $V_{IN} = 24V$ ,  $V_{OUT\_PR} = 5V$ ,  $V_{OUT\_SC} = -5V$  at  $I_{OUT\_PR} = 0.1A$ ,  $I_{OUT\_SC} = 0.1A$ , 700kHz, FCCM)

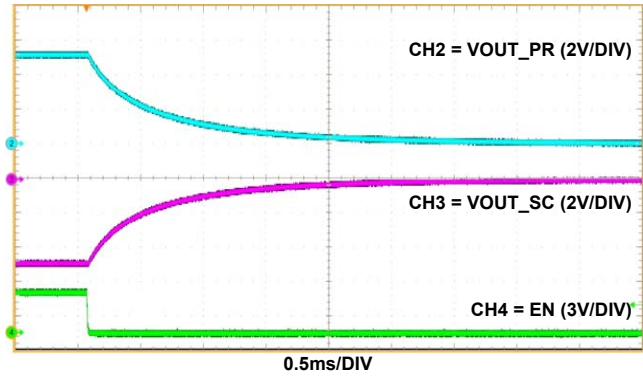

Figure 17. Shutdown by EN ( $V_{IN} = 24V$ ,  $V_{OUT\_PR} = 5V$ ,  $V_{OUT\_SC} = -5V$  at  $I_{OUT\_PR} = 0.1A$ ,  $I_{OUT\_SC} = 0.1A$ , 700kHz, FCCM)

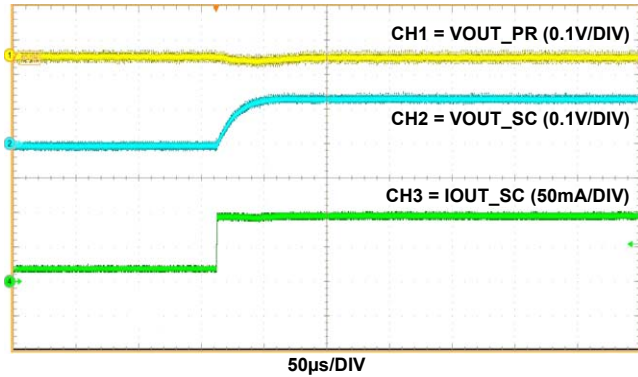

Figure 18. Loading Transient ( $V_{IN} = 24V$ ,  $V_{OUT\_PR} = 5V$ ,  $V_{OUT\_SC} = -5V$  at  $I_{OUT\_PR} = 0A$ ,  $I_{OUT\_SC} = 25mA$  to 75mA, 700kHz, FCCM)

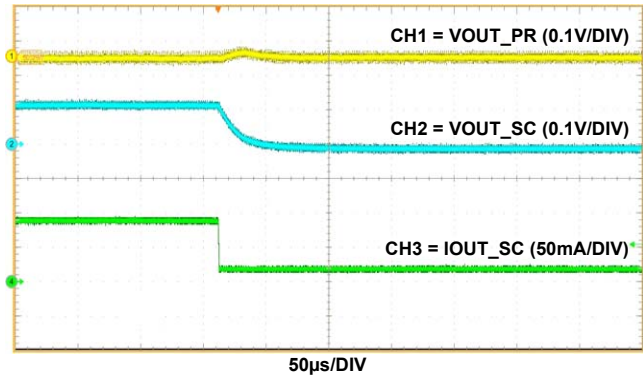

Figure 19. Unloading Transient ( $V_{IN} = 24V$ ,  $V_{OUT\_PR} = 5V$ ,  $V_{OUT\_SC} = -5V$  at  $I_{OUT\_PR} = 0A$ ,  $I_{OUT\_SC} = 75mA$  to 25mA, 700kHz, FCCM)

## 5. Revision History

Rev.	Date	Description
0.00	Jul 14, 2017	Initial release

## Notice

1. Descriptions of circuits, software and other related information in this document are provided only to illustrate the operation of semiconductor products and application examples. You are fully responsible for the incorporation or any other use of the circuits, software, and information in the design of your product or system. Renesas Electronics disclaims any and all liability for any losses and damages incurred by you or third parties arising from the use of these circuits, software, or information.
2. Renesas Electronics hereby expressly disclaims any warranties against and liability for infringement or any other claims involving patents, copyrights, or other intellectual property rights of third parties, by or arising from the use of Renesas Electronics products or technical information described in this document, including but not limited to, the product data, drawings, charts, programs, algorithms, and application examples.
3. No license, express, implied or otherwise, is granted hereby under any patents, copyrights or other intellectual property rights of Renesas Electronics or others.
4. You shall not alter, modify, copy, or reverse engineer any Renesas Electronics product, whether in whole or in part. Renesas Electronics disclaims any and all liability for any losses or damages incurred by you or third parties arising from such alteration, modification, copying or reverse engineering.
5. Renesas Electronics products are classified according to the following two quality grades: "Standard" and "High Quality". The intended applications for each Renesas Electronics product depends on the product's quality grade, as indicated below.  
"Standard": Computers; office equipment; communications equipment; test and measurement equipment; audio and visual equipment; home electronic appliances; machine tools; personal electronic equipment; industrial robots; etc.  
"High Quality": Transportation equipment (automobiles, trains, ships, etc.); traffic control (traffic lights); large-scale communication equipment; key financial terminal systems; safety control equipment; etc.  
Unless expressly designated as a high reliability product or a product for harsh environments in a Renesas Electronics data sheet or other Renesas Electronics document, Renesas Electronics products are not intended or authorized for use in products or systems that may pose a direct threat to human life or bodily injury (artificial life support devices or systems; surgical implantations; etc.), or may cause serious property damage (space system; undersea repeaters; nuclear power control systems; aircraft control systems; key plant systems; military equipment; etc.). Renesas Electronics disclaims any and all liability for any damages or losses incurred by you or any third parties arising from the use of any Renesas Electronics product that is inconsistent with any Renesas Electronics data sheet, user's manual or other Renesas Electronics document.
6. When using Renesas Electronics products, refer to the latest product information (data sheets, user's manuals, application notes, "General Notes for Handling and Using Semiconductor Devices" in the reliability handbook, etc.), and ensure that usage conditions are within the ranges specified by Renesas Electronics with respect to maximum ratings, operating power supply voltage range, heat dissipation characteristics, installation, etc. Renesas Electronics disclaims any and all liability for any malfunctions, failure or accident arising out of the use of Renesas Electronics products outside of such specified ranges.
7. Although Renesas Electronics endeavors to improve the quality and reliability of Renesas Electronics products, semiconductor products have specific characteristics, such as the occurrence of failure at a certain rate and malfunctions under certain use conditions. Unless designated as a high reliability product or a product for harsh environments in a Renesas Electronics data sheet or other Renesas Electronics document, Renesas Electronics products are not subject to radiation resistance design. You are responsible for implementing safety measures to guard against the possibility of bodily injury, injury or damage caused by fire, and/or danger to the public in the event of a failure or malfunction of Renesas Electronics products, such as safety design for hardware and software, including but not limited to redundancy, fire control and malfunction prevention, appropriate treatment for aging degradation or any other appropriate measures. Because the evaluation of microcomputer software alone is very difficult and impractical, you are responsible for evaluating the safety of the final products or systems manufactured by you.
8. Please contact a Renesas Electronics sales office for details as to environmental matters such as the environmental compatibility of each Renesas Electronics product. You are responsible for carefully and sufficiently investigating applicable laws and regulations that regulate the inclusion or use of controlled substances, including without limitation, the EU RoHS Directive, and using Renesas Electronics products in compliance with all these applicable laws and regulations. Renesas Electronics disclaims any and all liability for damages or losses occurring as a result of your noncompliance with applicable laws and regulations.
9. Renesas Electronics products and technologies shall not be used for or incorporated into any products or systems whose manufacture, use, or sale is prohibited under any applicable domestic or foreign laws or regulations. You shall comply with any applicable export control laws and regulations promulgated and administered by the governments of any countries asserting jurisdiction over the parties or transactions.
10. It is the responsibility of the buyer or distributor of Renesas Electronics products, or any other party who distributes, disposes of, or otherwise sells or transfers the product to a third party, to notify such third party in advance of the contents and conditions set forth in this document.
11. This document shall not be reprinted, reproduced or duplicated in any form, in whole or in part, without prior written consent of Renesas Electronics.
12. Please contact a Renesas Electronics sales office if you have any questions regarding the information contained in this document or Renesas Electronics products.  
(Note 1) "Renesas Electronics" as used in this document means Renesas Electronics Corporation and also includes its directly or indirectly controlled subsidiaries.  
(Note 2) "Renesas Electronics product(s)" means any product developed or manufactured by or for Renesas Electronics.

(Rev.4.0-1 November 2017)



### SALES OFFICES

Renesas Electronics Corporation

<http://www.renesas.com>

Refer to "<http://www.renesas.com/>" for the latest and detailed information.

#### **Renesas Electronics America Inc.**

1001 Murphy Ranch Road, Milpitas, CA 95035, U.S.A.  
Tel: +1-408-432-8888, Fax: +1-408-434-5351

#### **Renesas Electronics Canada Limited**

9251 Yonge Street, Suite 8309 Richmond Hill, Ontario Canada L4C 9T3  
Tel: +1-905-237-2004

#### **Renesas Electronics Europe Limited**

Dukes Meadow, Millboard Road, Bourne End, Buckinghamshire, SL8 5FH, U.K  
Tel: +44-1628-651-700, Fax: +44-1628-651-804

#### **Renesas Electronics Europe GmbH**

Arcadiastrasse 10, 40472 Düsseldorf, Germany  
Tel: +49-211-6503-0, Fax: +49-211-6503-1327

#### **Renesas Electronics (China) Co., Ltd.**

Room 1709 Quantum Plaza, No.27 ZhichunLu, Haidian District, Beijing, 100191 P. R. China  
Tel: +86-10-8235-1155, Fax: +86-10-8235-7679

#### **Renesas Electronics (Shanghai) Co., Ltd.**

Unit 301, Tower A, Central Towers, 555 Langao Road, Putuo District, Shanghai, 200333 P. R. China  
Tel: +86-21-2226-0888, Fax: +86-21-2226-0999

#### **Renesas Electronics Hong Kong Limited**

Unit 1601-1611, 16/F., Tower 2, Grand Century Place, 193 Prince Edward Road West, Mongkok, Kowloon, Hong Kong  
Tel: +852-2265-6688, Fax: +852 2886-9022

#### **Renesas Electronics Taiwan Co., Ltd.**

13F, No. 363, Fu Shing North Road, Taipei 10543, Taiwan  
Tel: +886-2-8175-9600, Fax: +886 2-8175-9670

#### **Renesas Electronics Singapore Pte. Ltd.**

80 Bendemeer Road, Unit #06-02 Hyflux Innovation Centre, Singapore 339949  
Tel: +65-6213-0200, Fax: +65-6213-0300

#### **Renesas Electronics Malaysia Sdn.Bhd.**

Unit 1207, Block B, Menara Amcorp, Amcorp Trade Centre, No. 18, Jln Persiaran Barat, 46050 Petaling Jaya, Selangor Darul Ehsan, Malaysia  
Tel: +60-3-7955-9390, Fax: +60-3-7955-9510

#### **Renesas Electronics India Pvt. Ltd.**

No.777C, 100 Feet Road, HAL 2nd Stage, Indiranagar, Bangalore 560 038, India  
Tel: +91-80-67208700, Fax: +91-80-67208777

#### **Renesas Electronics Korea Co., Ltd.**

17F, KAMCO Yangjae Tower, 262, Gangnam-daero, Gangnam-gu, Seoul, 06265 Korea  
Tel: +82-2-558-3737, Fax: +82-2-558-5338

ISL85413DEMO3Z

