

ISL85410DEMO1Z, ISL854102DEMO1Z, ISL85418DEMO1Z

Demonstration Boards User Guide

AN1908
Rev.3.00
Nov 18, 2016

Description

The ISL85410DEMO1Z, ISL854102DEMO1Z, and ISL85418DEMO1Z boards are intended for use in point-of-load applications sourcing from 3V to 40V. The boards are used to demonstrate the performance of the [ISL85410](#), [ISL854102](#), and [ISL85418](#) wide V_{IN} , low quiescent current, high-efficiency synchronous buck regulators with 1A (ISL85410), 1.2A (ISL854102), and 800mA (ISL85418) output current.

The ISL85410, ISL854102, and ISL85418 are offered in a 4mmx3mm 12 Ld DFN package with 1mm maximum height. The converter occupies 1.516cm² area.

Key Specifications

These boards have been configured and optimized for the following operating conditions:

- $V_{IN} = 24V$
- $V_{OUT} = 3.3V$
- $I_{MAX} = 1A$ (ISL85410), 1.2A (ISL854102), and 800mA (ISL85418)
- $f_{SW} = 500kHz$
- Peak efficiency: >84% at 50% load
- Output ripple: <10mV at 1.2A
- Dynamic response: 4.5%
 - 0A to 1.2A and 1.2A to 0A steps, PWM, di/dt = 1A/ μ s)
- Board temperature: +25°C

Key Features

- Wide input voltage range 3V to 40V
- Synchronous operation for high efficiency
- No compensation required
- Integrated high-side and low-side NMOS devices
- Selectable PFM or forced PWM mode at light loads
- Internal fixed (500kHz) or adjustable switching frequency 300kHz to 2MHz
- Continuous output current up to 1A (ISL85410), 1.2A (ISL854102) and 800mA (ISL85418)
- Internal or external soft-start
- Minimal external components required
- Power-good and enable functions available

Related Literature

- For a full list of related documents, visit our website
 - [ISL85410](#), [ISL854102](#), and [ISL85418](#) product pages

Ordering Information

PART NUMBER	DESCRIPTION
ISL85410DEMO1Z	Demonstration Board (1A output current)
ISL854102DEMO1Z	Demonstration Board (1.2A output current)
ISL85418DEMO1Z	Demonstration Board (800mA output current)

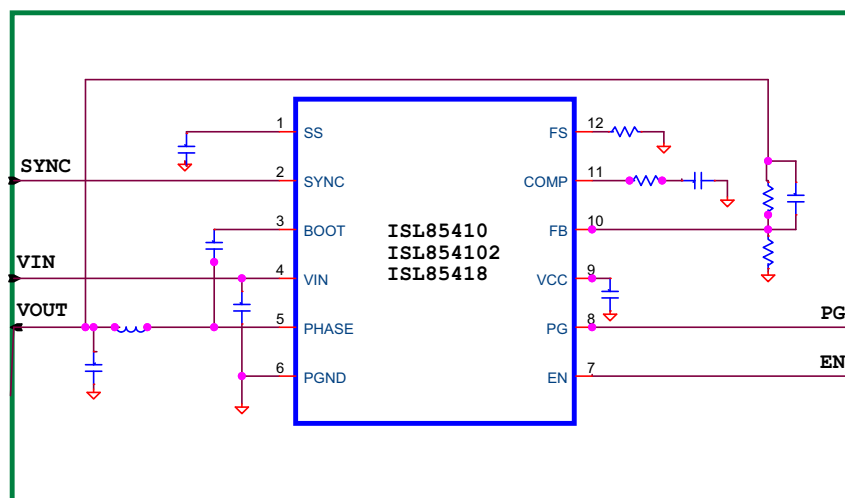

FIGURE 1. BLOCK DIAGRAM

Recommended Equipment

The following materials are recommended to perform testing:

- 0V to 50V power supply with at least 2A source current capability
- Electronic loads capable of sinking current up to 2A
- Digital Multimeters (DMMs)
- 100MHz quad-trace oscilloscope
- Signal generator

Quick Setup Guide

1. Ensure that the circuit is correctly connected to the supply and loads prior to applying any power.
2. Connect the bias supply to VIN, the plus terminal to VIN (P4) and the negative return to GND (P5).
3. Turn on the power supply.
4. Verify the output voltage is 3.3V for V_{OUT}.

Evaluating the Other Output Voltage

The ISL85410DEMO1Z, ISL854102DEMO1Z, and ISL85418DEMO1Z board outputs are preset to 3.3V; however, output voltages can be adjusted from 0.6V to 15V. The output voltage programming resistor, R₂, will depend on the desired output voltage of the regulator and the value of the feedback resistor R₁, as shown in [Equation 1](#).

$$R_2 = R_1 \left(\frac{0.6}{V_{OUT} - 0.6} \right) \quad (\text{EQ. 1})$$

If the output voltage desired is 0.6V, then R₁ is shorted. Please note that if V_{OUT} is less than 1.8V, the switching frequency and compensation must be changed for 300kHz operation due to minimum on-time limitation. Please refer to datasheets [ISL85410](#), [ISL854102](#) and [ISL85418](#) for further information.

[Table 1](#) shows the component selection that should be used for the respective V_{OUT}.

TABLE 1. EXTERNAL COMPONENT SELECTION

V _{OUT} (V)	L ₁ (μH)	C ₅ +C ₆ (μF)	R ₁ (kΩ)	R ₂ (kΩ)	C ₄ (pF)	R ₁₂ (kΩ)	R ₃ (kΩ)	C ₇ (pF)
12	22	2x22	90.9	4.75	22	115	150	470
5	22	47+22	90.9	12.4	27	DNP (Note 1)	100	470
3.3	22	47+22	90.9	20	27	DNP (Note 1)	100	470
2.5	22	47+22	90.9	28.7	27	DNP (Note 1)	100	470
1.8	12	47+22	90.9	45.5	27	DNP (Note 1)	70	470

NOTE:

1. Connect FS to VCC.

Frequency Control

The ISL85410, ISL854102, and ISL85418 have an FS pin that controls the frequency of operation. Programmable frequency allows for optimization between efficiency and external component size. It also allows low frequency operation for low V_{OUT}s when minimum on-time would limit the operation otherwise. Default switching frequency is 500kHz when FS is tied to VCC (R₁₀ = 0). By removing R₁₀, the switching frequency can be changed from 300kHz (R₁₂ = 340k) to 2MHz (R₁₂ = 32.4k). Please refer to datasheets [ISL85410](#), [ISL854102](#) and [ISL85418](#) for calculating the value of R₁₀. Do not leave this pin floating.

SYNC Control

The ISL85410, ISL854102, and ISL85418 demo boards have a SYNC pin that allows external synchronization frequency to be applied. Default board configuration has R₆ = 200k to V_{CC}, which defaults to PWM operation mode and also to the preselected switching frequency set by R₁₂ (see datasheet and previous section "[Frequency Control](#)" for details). If this pin is tied to GND, the IC will operate in PFM mode. The S2 switch allows forced PFM or PWM modes.

Soft-Start/COMP Control

R₁₅ selects between internal (R₁₅ = 0) and external soft-start. R₁₁ selects between internal (R₁₁ = 0) and external compensation. For applications where repetitive restarts of the IC are required, it is recommended to add a 350kΩ resistor in parallel to CSS in order to allow its fast discharge. Please refer to Pin Description Table of the [ISL85410](#), [ISL854102](#) and [ISL85418](#) datasheets.

Demonstration Boards (Front and Back)

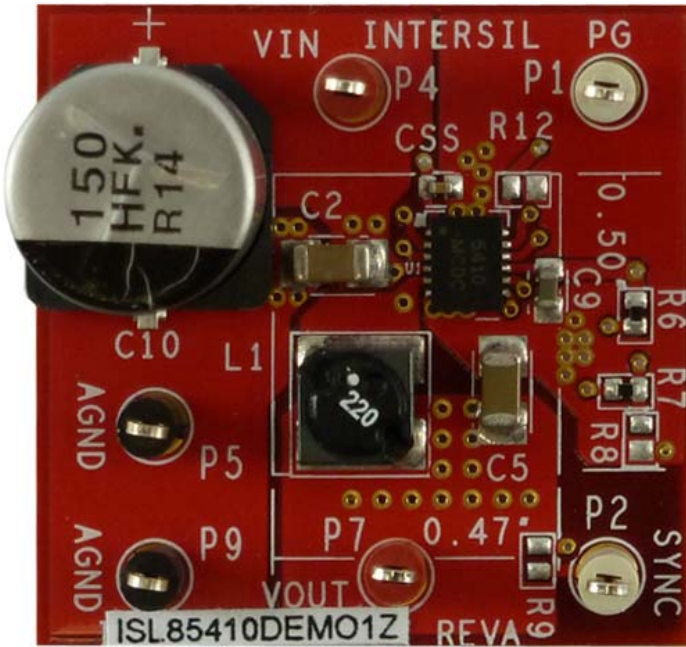

FIGURE 2. ISL85410DEMO1Z DEMONSTRATION BOARD (TOP)

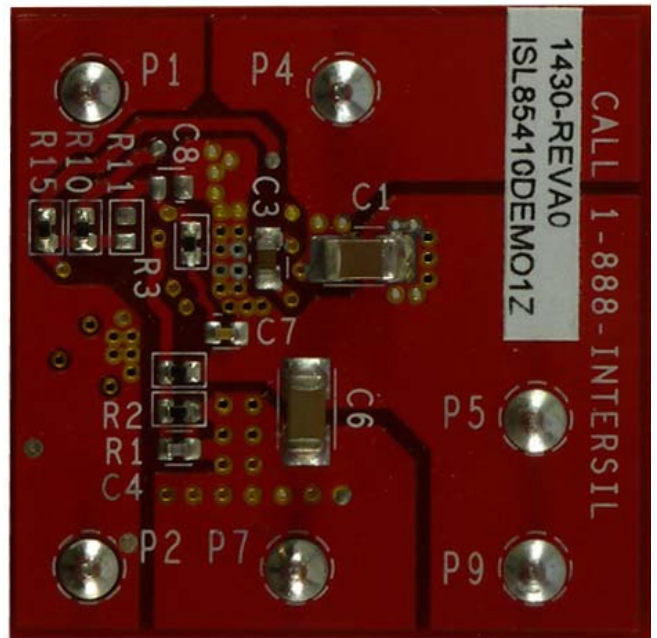

FIGURE 3. ISL85410DEMO1Z DEMONSTRATION BOARD (BOTTOM)



FIGURE 4. ISL854102DEMO1Z DEMONSTRATION BOARD (TOP)

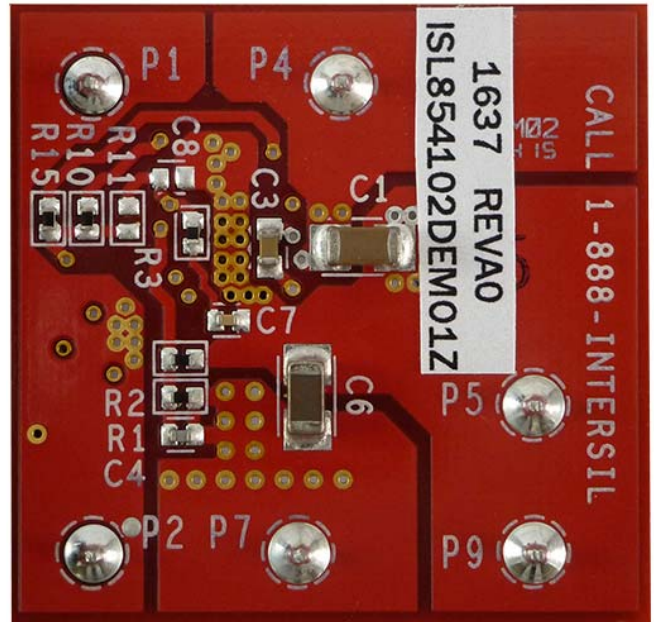

FIGURE 5. ISL854102DEMO1Z DEMONSTRATION BOARD (BOTTOM)

Demonstration Boards (Front and Back) (Continued)

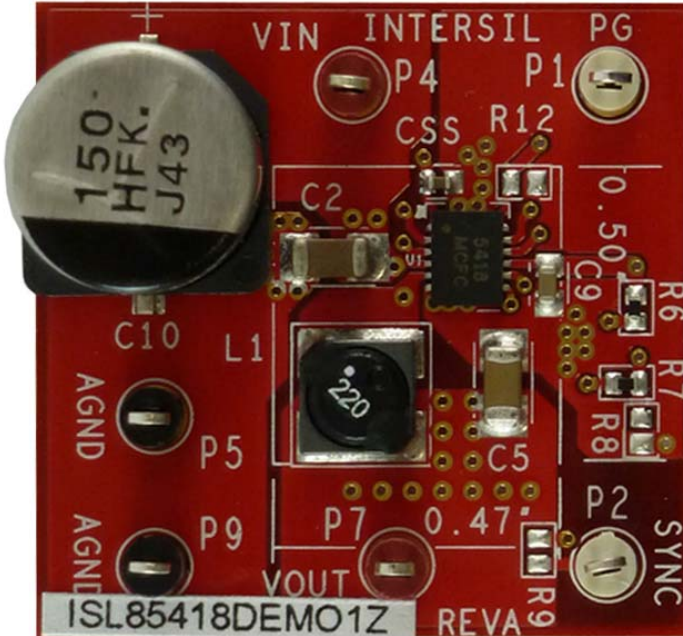

FIGURE 6. ISL85418DEMO1Z DEMONSTRATION BOARD (TOP)

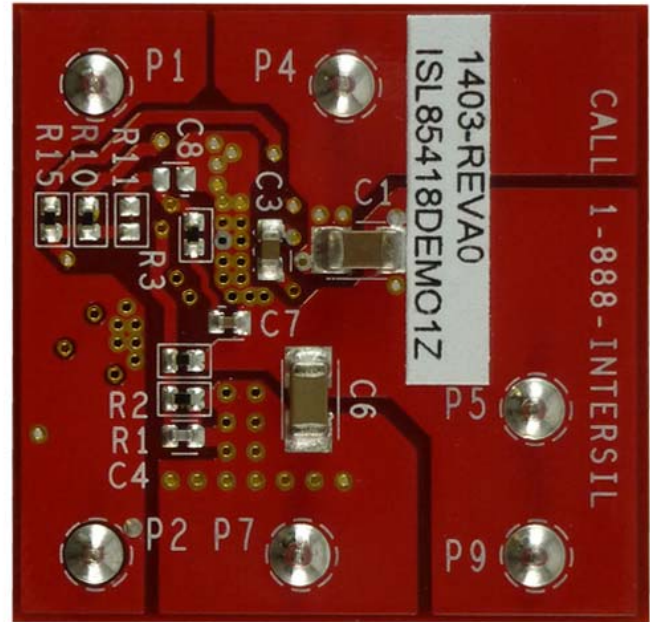
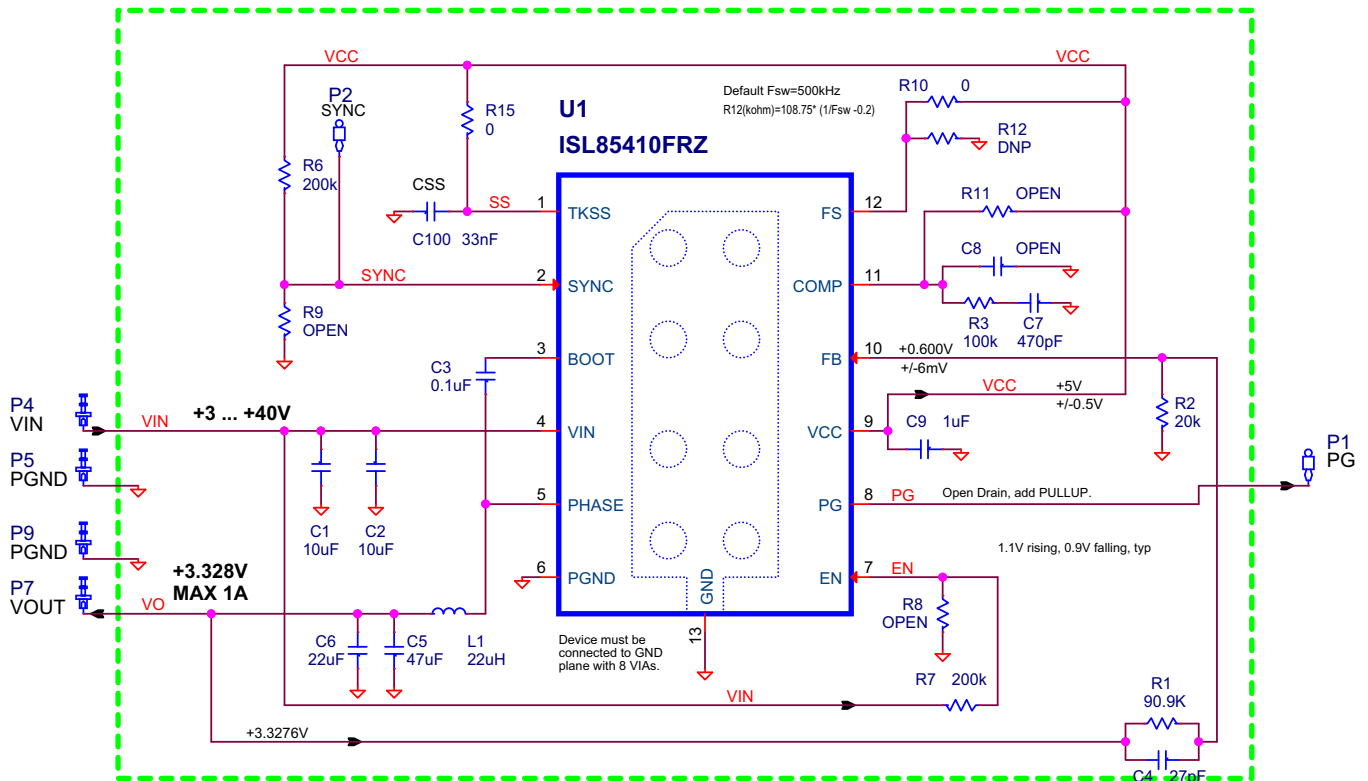

FIGURE 7. ISL85418DEMO1Z DEMONSTRATION BOARD (BOTTOM)

ISL85410DEMO1Z, ISL854102DEMO1Z, AND ISL85418DEMO1Z Schematics



NOTE: The input electrolytic capacitor C₁₀ is optional and it is used to prevent transient voltages when the input test leads have large parasitic inductance. It can be removed if the IC is used in a system application.

FIGURE 8. ISL85410DEMO1Z SCHEMATIC

ISL85410DEMO1Z, ISL854102DEMO1Z, AND ISL85418DEMO1Z Schematics (Continued)

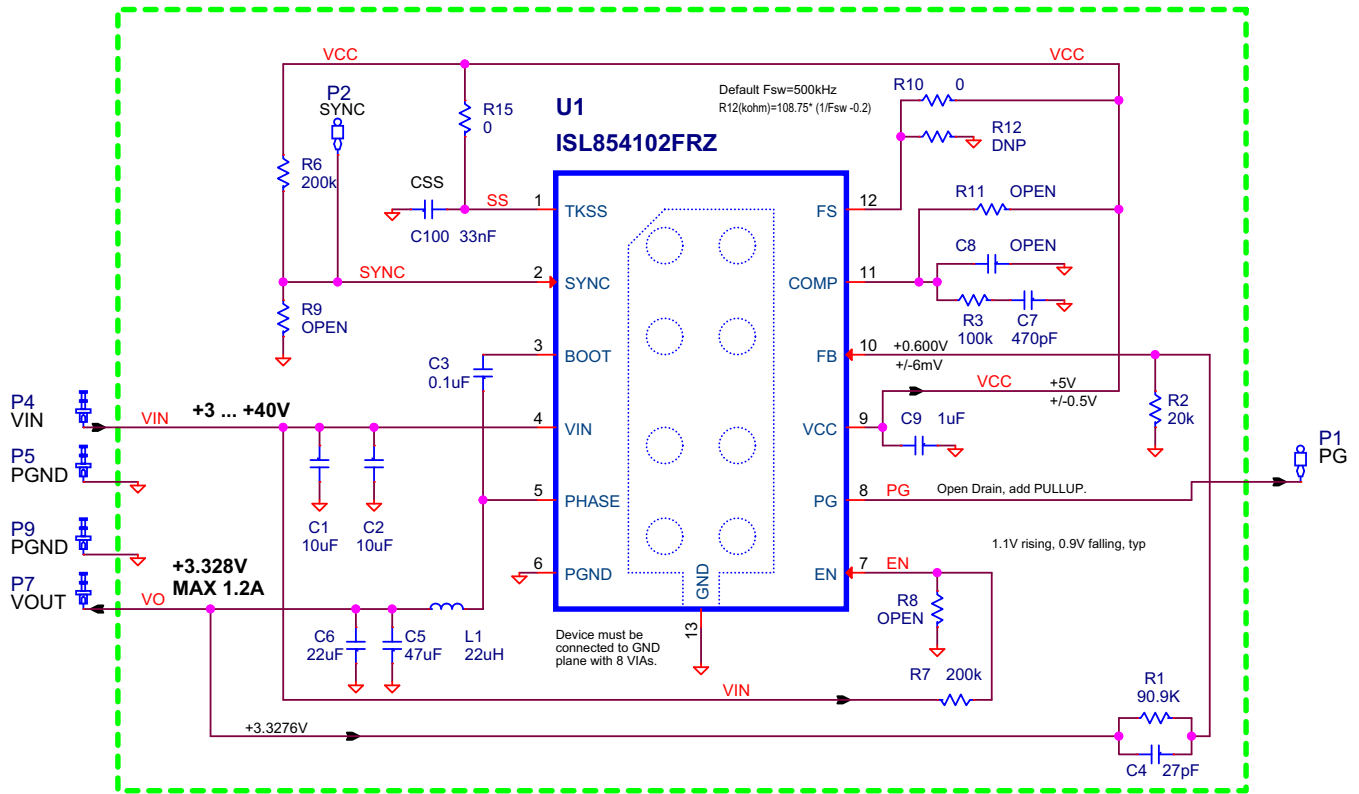

NOTE: The input electrolytic capacitor C₁₀ is optional and it is used to prevent transient voltages when the input test leads have large parasitic inductance. It can be removed if the IC is used in a system application.

FIGURE 9. ISL854102DEMO1Z SCHEMATIC

ISL85410DEMO1Z, ISL854102DEMO1Z, AND ISL85418DEMO1Z Schematics (Continued)

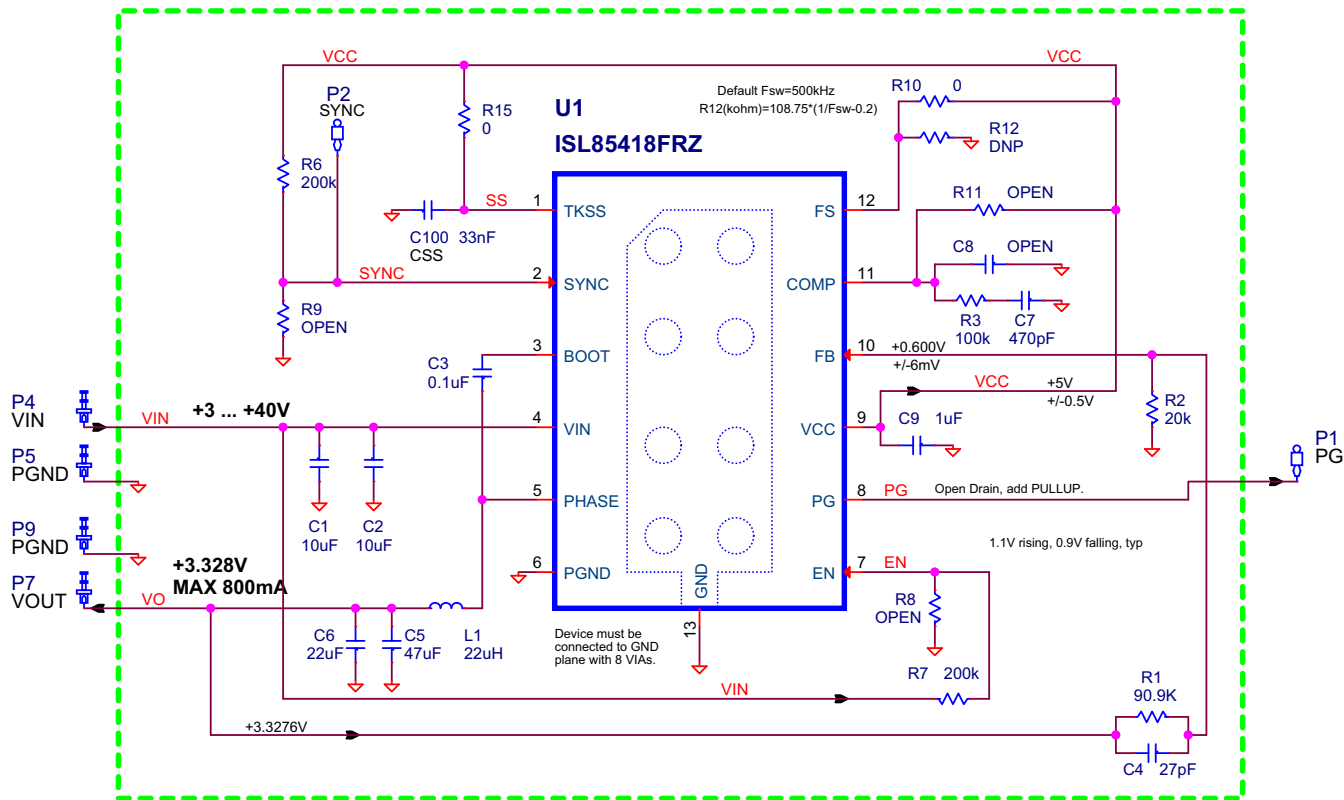

NOTE: The input electrolytic capacitor C₁₀ is optional and it is used to prevent transient voltages when the input test leads have large parasitic inductance. It can be removed if the IC is used in a system application.

FIGURE 10. ISL85418DEMO1Z SCHEMATIC

ISL85410DEMO1Z, ISL854102DEMO1Z, ISL85418DEMO1Z BOM

MANUFACTURER PART	QTY	UNITS	REFERENCE DESIGNATOR	DESCRIPTION	MFR.
ISL85400EVAL2ZREVAPCB	1	ea	LABEL-RENAME BOARD	PWB-PCB, ISL85400EVAL2Z, REVA, ROHS	IMAGINEERING
EEE-FK1H151P	1	ea	C10 (OPTIONAL)	CAP, SMD, 10.3mm, 150µF, 50V, 20%, AL.EL., ROHS	PANASONIC
GRM36COG270J050AQ	1	ea	C4	CAP, SMD, 0402, 27pF, 50V, 5%, NP0, ROHS	MURATA
GRM36X7R333K016AQ	1	ea	CSS	CAP, SMD, 0402, 33000pF, 16V, 10%, X7R, ROHS	MURATA
ECJ-0EB1H471K	1	ea	C7	CAP, SMD, 0402, 470pF, 50V, 10%, X7R, ROHS	PANASONIC
	0	ea	C8	CAP, SMD, 0402, DNP-PLACE HOLDER, ROHS	
06035C104KAT2A	1	ea	C3	CAP, SMD, 0603, 0.1µF, 50V, 10%, X7R, ROHS	AVX
GRM188R61C105KA12D	1	ea	C9	CAP, SMD, 0603, 1µF, 16V, 10%, X5R, ROHS	MURATA
C3216X5R1H106K	2	ea	C1, C2	CAP, SMD, 1206, 10µF, 50V, 10%, X5R, ROHS	TDK
GRM31CR60J226KE19L	1	ea	C6	CAP, SMD, 1206, 22µF, 6.3V, 10%, X5R, ROHS	MURATA
GRM31CR60J476KE19L	1	ea	C5	CAP, SMD, 1206, 47µF, 6.3V, 10%, X5R, ROHS	MURATA
74404054220	1	ea	L1	COIL-PWR INDUCTOR, SMD, 5mm, 22µH, 20%, 1.5A, ROHS	Würth Electronics
5000	2	ea	P4, P7	CONN-MINI TEST PT, VERTICAL, RED, ROHS	KEYSTONE
5001	2	ea	P5, P9	CONN-MINI TEST PT, VERTICAL, BLK, ROHS	KEYSTONE
5002	2	ea	P1, P2	CONN-MINI TEST POINT, VERTICAL, WHITE, ROHS	KEYSTONE
ISL85410FRZ for ISL85410DEMO1Z ISL854102FRZ for ISL854102DEMO1Z ISL85418FRZ for ISL85418DEMO1Z	1	ea	U1	IC-40V, BUCK REGULATOR, 12P, DFN, 3X4, ROHS	INTERSIL
CR0402-16W-00T	2	ea	R10, R15	RES, SMD, 0402, 0Ω, 1/16W, 5%, TF, ROHS	VENKEL
ERJ2RKF1003	1	ea	R3	RES, SMD, 0402, 100k, 1/16W, 1%, TF, ROHS	PANASONIC
ERJ2RKF2001	1	ea	R2	RES, SMD, 0402, 20k, 1/16W, 1%, TF, ROHS	PANASONIC
MCR01MZPF2003	2	ea	R6, R7	RES, SMD, 0402, 200k, 1/16W, 1%, TF, ROHS	ROHM
CRCW040290K9FKED	1	ea	R1	RES, SMD, 0402, 90.9k, 1/16W, 1%, TF, ROHS	VISHAY/DALE
	0	ea	R12	RES, SMD, 0402, DNP, DNP, DNP, TF, ROHS	
	0	ea	R8, R9, R11	RES, SMD, 0402, DNP, DNP, DNP, TF, ROHS	

ISL85410DEMO1Z, ISL854102DEMO1Z and ISL85418DEMO1Z Board Layout

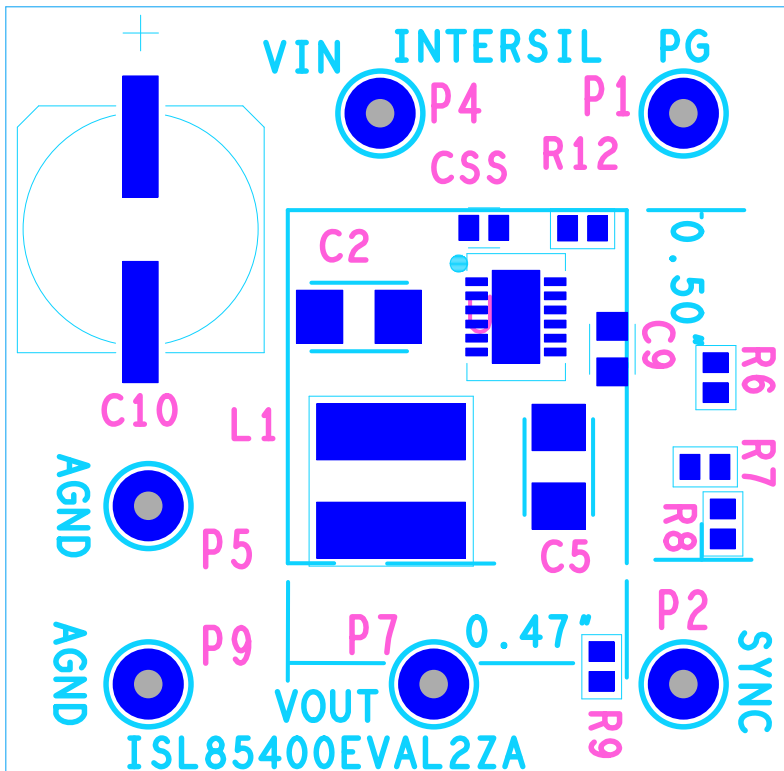

FIGURE 11. SILK SCREEN TOP

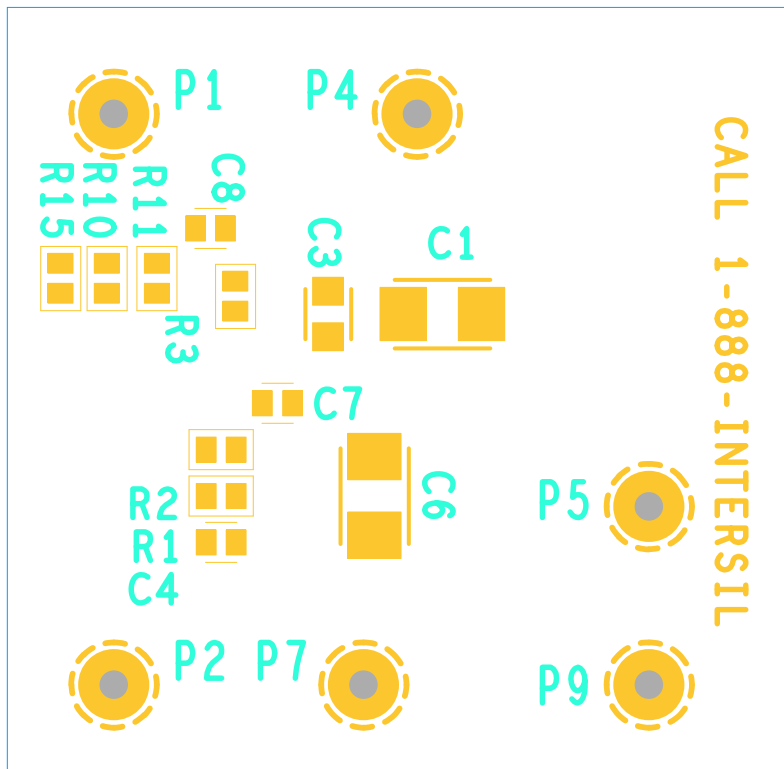

FIGURE 12. SILK SCREEN BOTTOM

ISL85410DEMO1Z, ISL854102DEMO1Z and ISL85418DEMO1Z Board Layout (Continued)

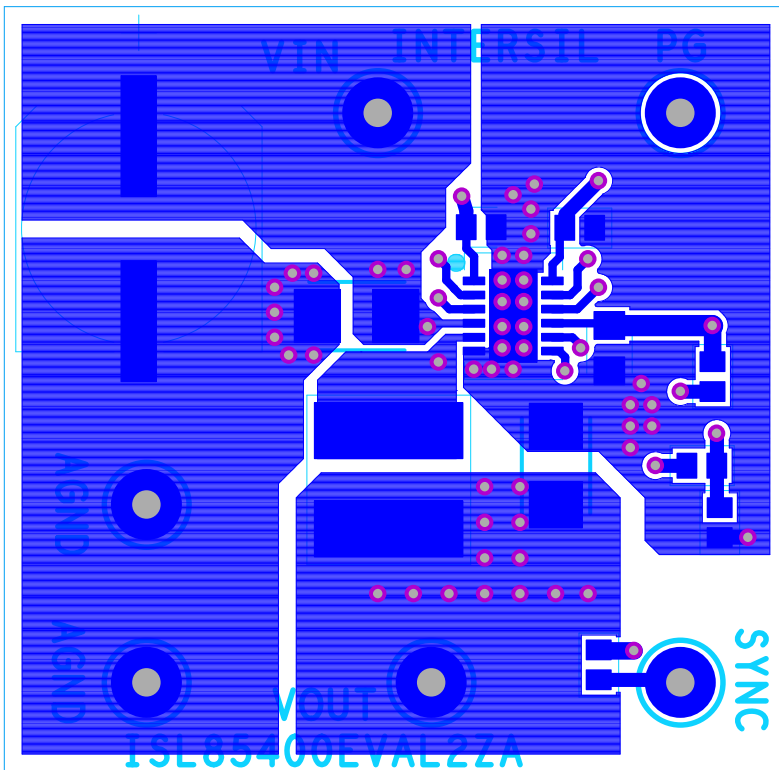

FIGURE 13. LAYER 1

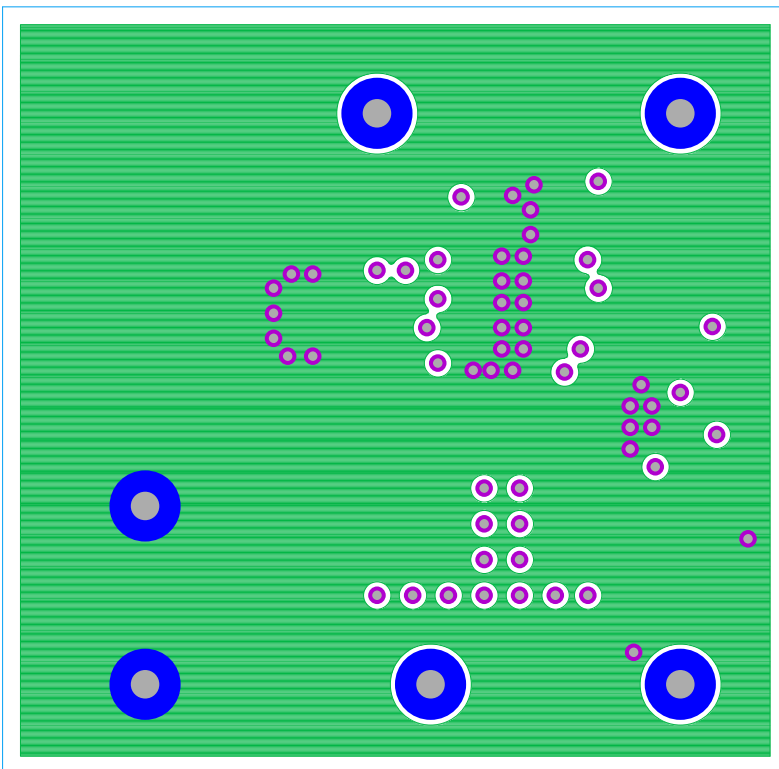

FIGURE 14. LAYER 2

ISL85410DEMO1Z, ISL854102DEMO1Z and ISL85418DEMO1Z Board Layout (Continued)

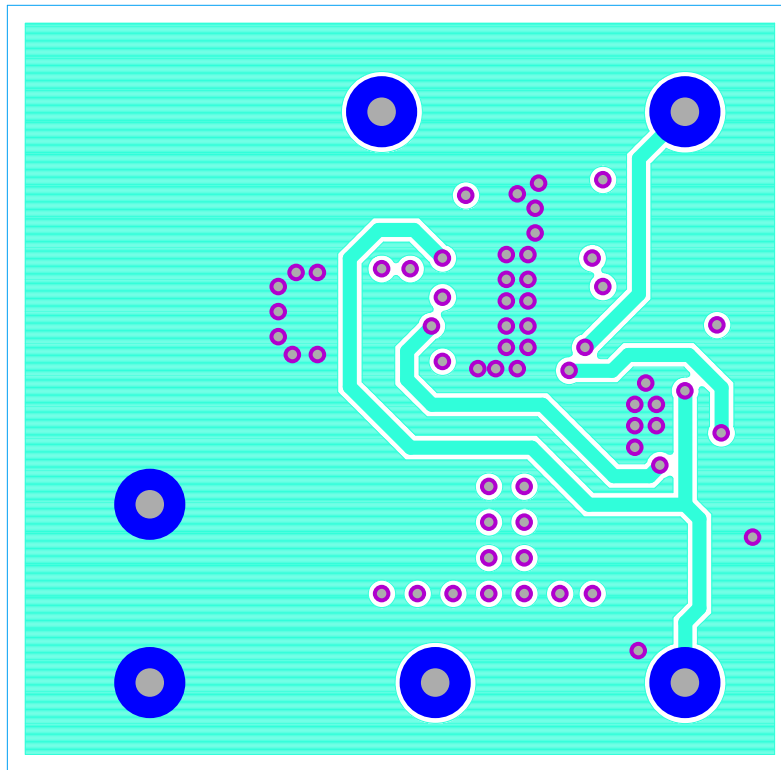

FIGURE 15. LAYER 3

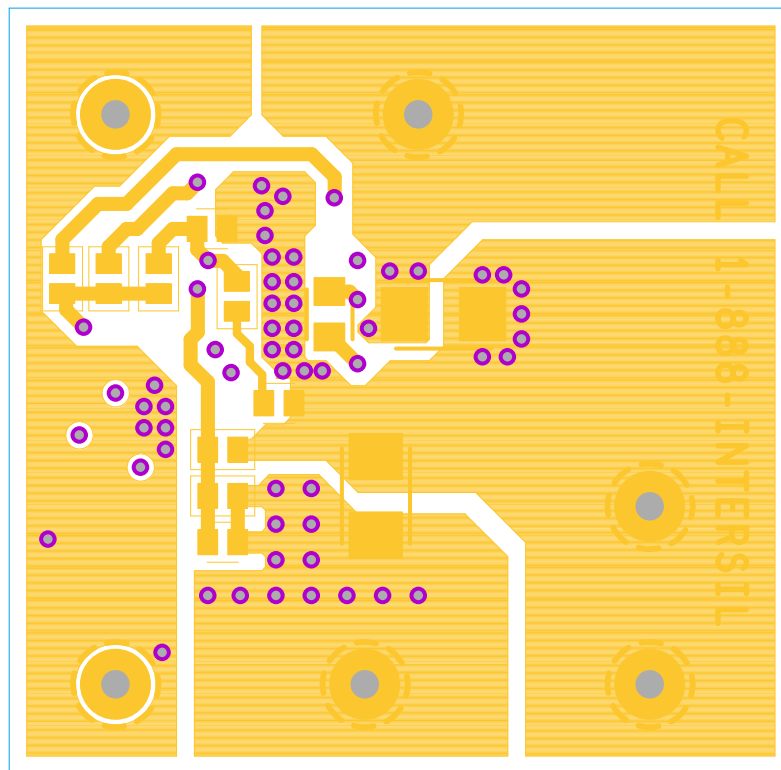

FIGURE 16. LAYER 4 BOTTOM VIEW

ISL85410 Efficiency Curves $f_{SW} = 500kHz, T_A = +25^\circ C$

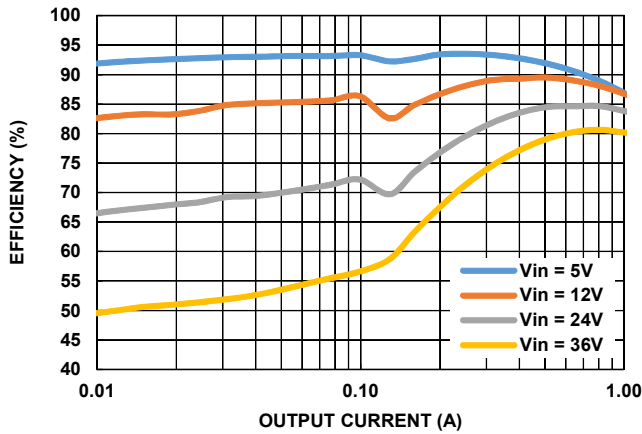

FIGURE 17. EFFICIENCY vs LOAD, PFM, $V_{OUT} = 3.3V$

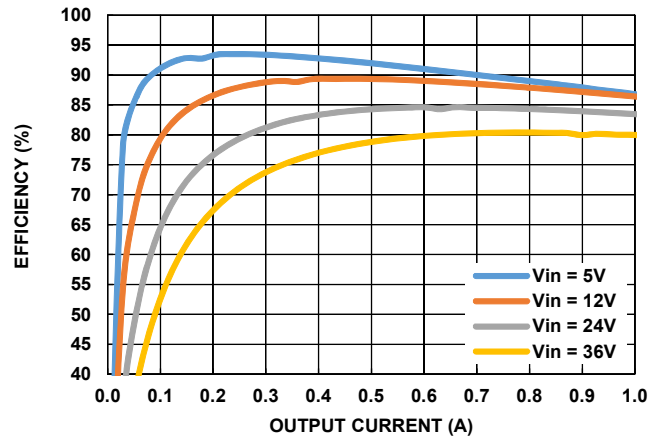

FIGURE 18. EFFICIENCY vs LOAD, PWM, $V_{OUT} = 3.3V$

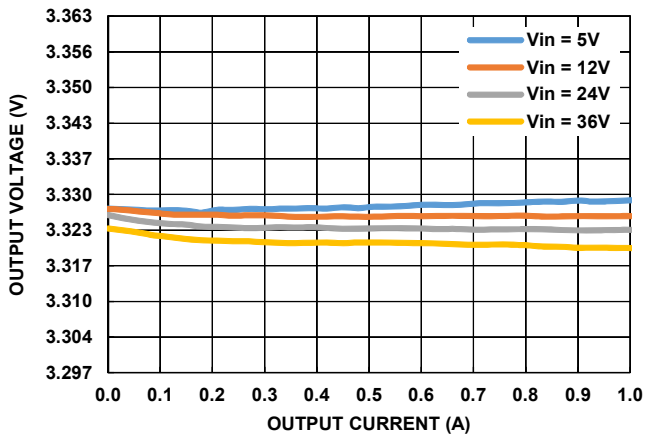

FIGURE 19. V_{OUT} REGULATION vs LOAD, PWM, $V_{OUT} = 3.3V$

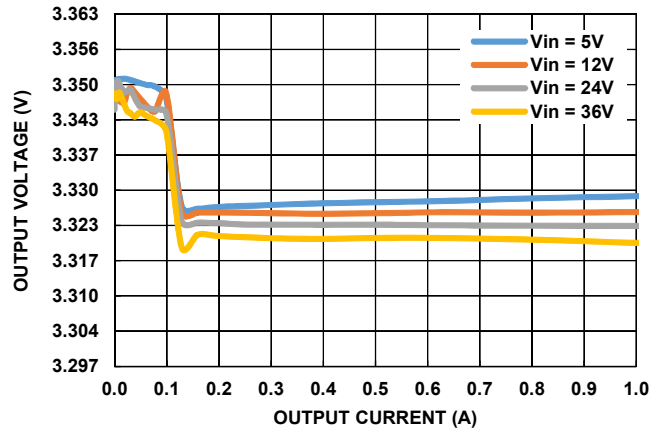

FIGURE 20. V_{OUT} REGULATION vs LOAD, PFM, $V_{OUT} = 3.3V$

ISL85410 Measurement $f_{SW} = 500kHz, V_{IN} = 24V, V_{OUT} = 3.3V, T_A = +25^\circ C$

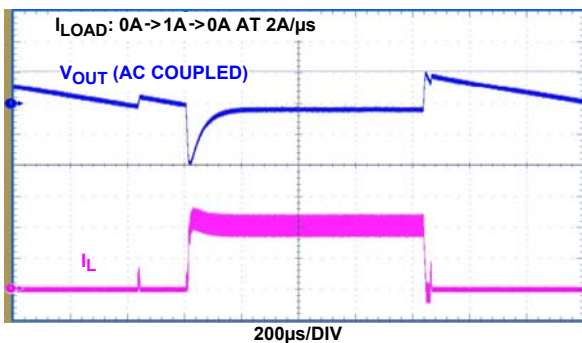

FIGURE 21. LOAD TRANSIENT, PFM

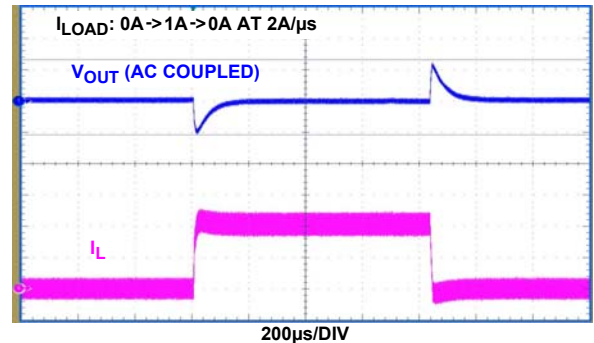

FIGURE 22. LOAD TRANSIENT, PWM

ISL854102 Efficiency Curves $f_{SW} = 500kHz, T_A = +25^\circ C$

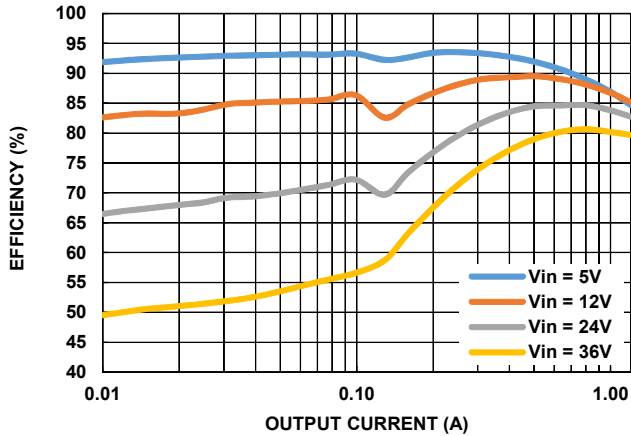

FIGURE 23. EFFICIENCY vs LOAD, PFM, $V_{OUT} = 3.3V, L_1 = 22\mu H$

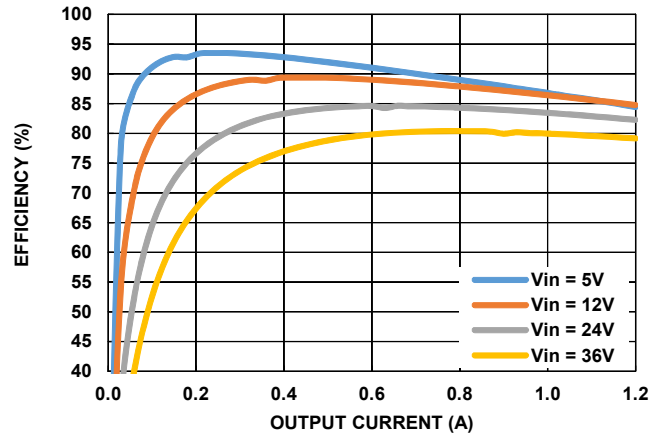

FIGURE 24. EFFICIENCY vs LOAD, PWM, $V_{OUT} = 3.3V, L_1 = 22\mu H$

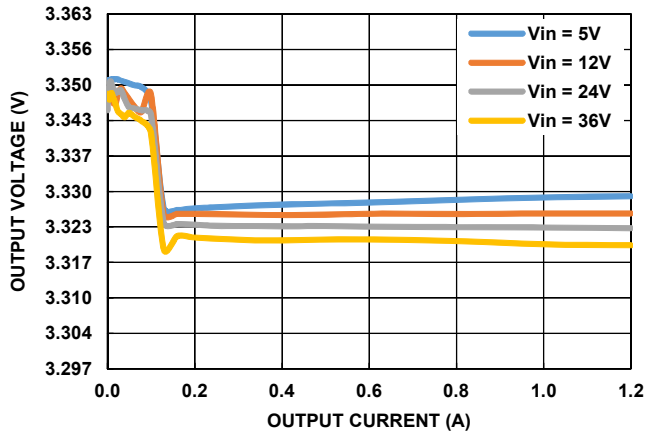

FIGURE 25. V_{OUT} REGULATION vs LOAD, PFM, $V_{OUT} = 3.3V$

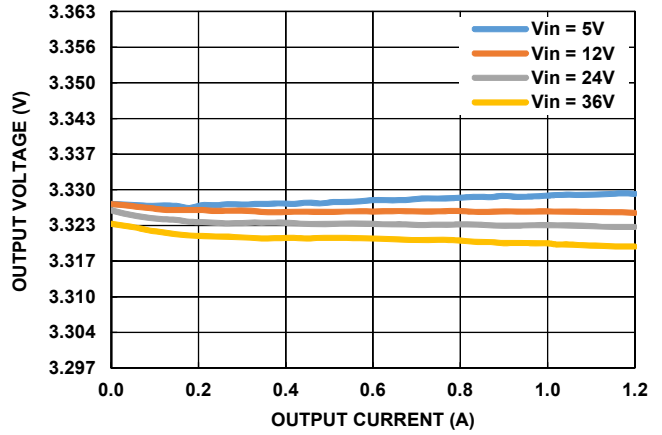

FIGURE 26. V_{OUT} REGULATION vs LOAD vs LOAD, PWM, $V_{OUT} = 3.3V$

ISL854102 Measurement $f_{SW} = 500kHz, V_{IN} = 24V, V_{OUT} = 3.3V, T_A = +25^\circ C$

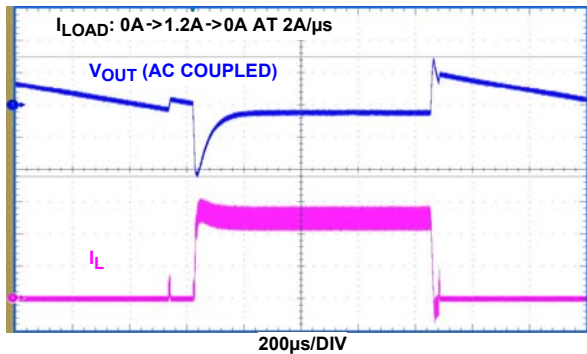

FIGURE 27. LOAD TRANSIENT, PFM

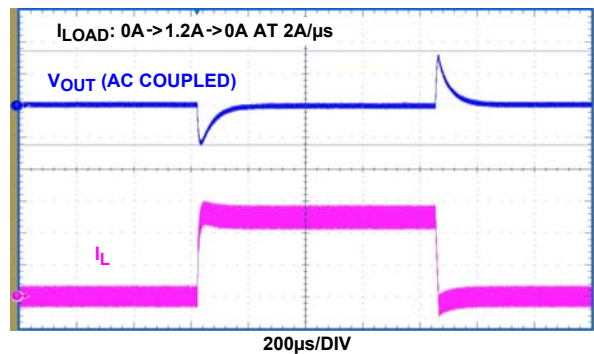

FIGURE 28. LOAD TRANSIENT, PWM

ISL85418 Efficiency Curves $f_{SW} = 500kHz, T_A = +25^\circ C.$

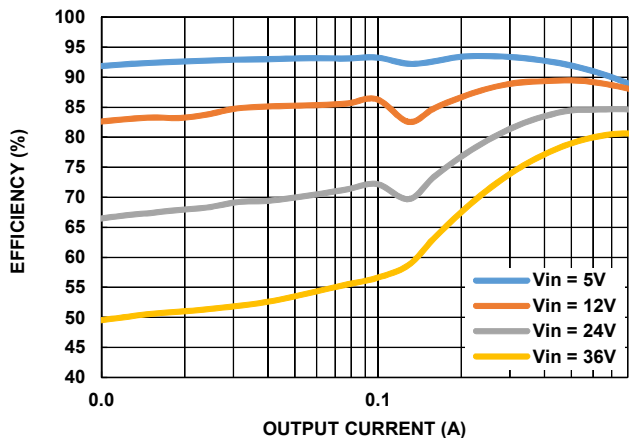

FIGURE 29. EFFICIENCY vs LOAD, PFM, $V_{OUT} = 3.3V$

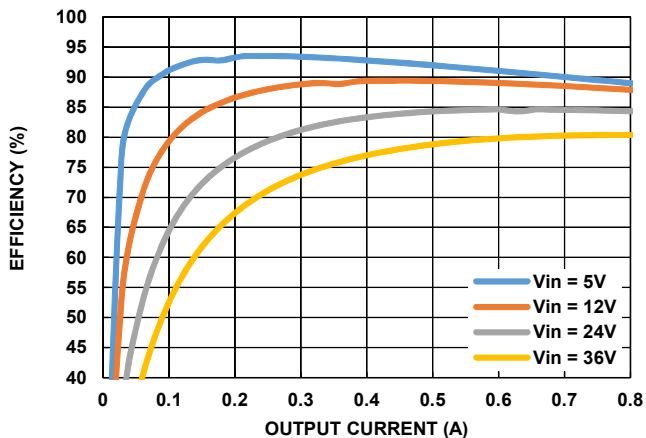

FIGURE 30. EFFICIENCY vs LOAD, PWM, $V_{OUT} = 3.3V$

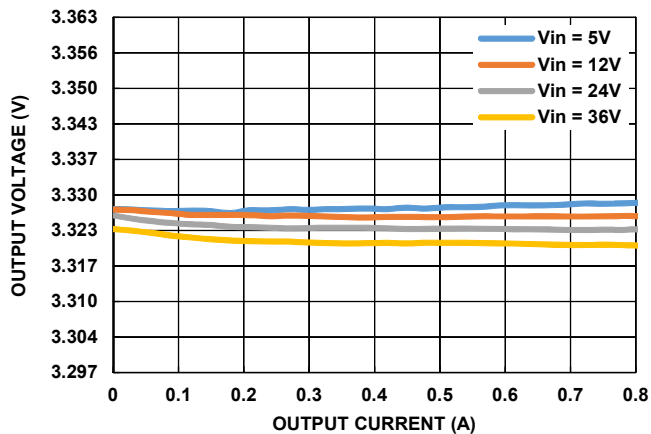

FIGURE 31. V_{OUT} REGULATION vs LOAD, PWM, $V_{OUT} = 3.3V$

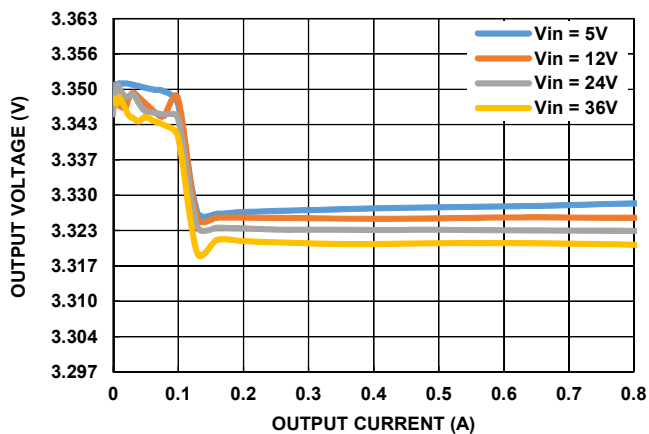

FIGURE 32. V_{OUT} REGULATION vs LOAD, PFM, $V_{OUT} = 3.3V$

ISL85418 Measurement $f_{SW} = 500kHz, V_{IN} = 24V, V_{OUT} = 3.3V, T_A = +25^\circ C$

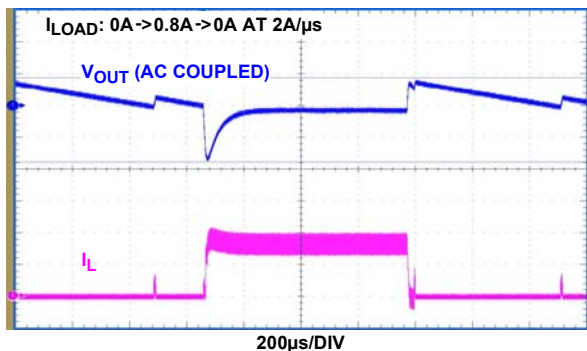

FIGURE 33. LOAD TRANSIENT, PFM

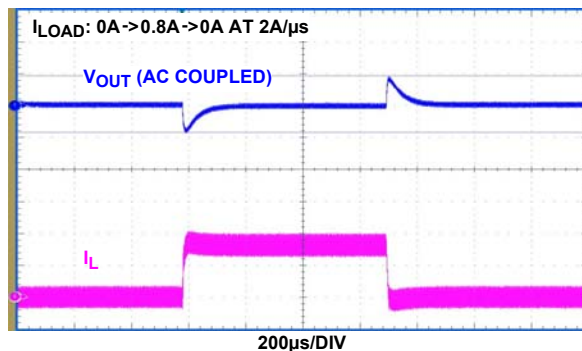

FIGURE 34. LOAD TRANSIENT, PWM

Notice

1. Descriptions of circuits, software and other related information in this document are provided only to illustrate the operation of semiconductor products and application examples. You are fully responsible for the incorporation or any other use of the circuits, software, and information in the design of your product or system. Renesas Electronics disclaims any and all liability for any losses and damages incurred by you or third parties arising from the use of these circuits, software, or information.
 2. Renesas Electronics hereby expressly disclaims any warranties against and liability for infringement or any other claims involving patents, copyrights, or other intellectual property rights of third parties, by or arising from the use of Renesas Electronics products or technical information described in this document, including but not limited to, the product data, drawings, charts, programs, algorithms, and application examples.
 3. No license, express, implied or otherwise, is granted hereby under any patents, copyrights or other intellectual property rights of Renesas Electronics or others.
 4. You shall not alter, modify, copy, or reverse engineer any Renesas Electronics product, whether in whole or in part. Renesas Electronics disclaims any and all liability for any losses or damages incurred by you or third parties arising from such alteration, modification, copying or reverse engineering.
 5. Renesas Electronics products are classified according to the following two quality grades: "Standard" and "High Quality". The intended applications for each Renesas Electronics product depends on the product's quality grade, as indicated below.
"Standard": Computers; office equipment; communications equipment; test and measurement equipment; audio and visual equipment; home electronic appliances; machine tools; personal electronic equipment; industrial robots; etc.
"High Quality": Transportation equipment (automobiles, trains, ships, etc.); traffic control (traffic lights); large-scale communication equipment; key financial terminal systems; safety control equipment; etc.
Unless expressly designated as a high reliability product or a product for harsh environments in a Renesas Electronics data sheet or other Renesas Electronics document, Renesas Electronics products are not intended or authorized for use in products or systems that may pose a direct threat to human life or bodily injury (artificial life support devices or systems; surgical implantations; etc.), or may cause serious property damage (space system; undersea repeaters; nuclear power control systems; aircraft control systems; key plant systems; military equipment; etc.). Renesas Electronics disclaims any and all liability for any damages or losses incurred by you or any third parties arising from the use of any Renesas Electronics product that is inconsistent with any Renesas Electronics data sheet, user's manual or other Renesas Electronics document.
 6. When using Renesas Electronics products, refer to the latest product information (data sheets, user's manuals, application notes, "General Notes for Handling and Using Semiconductor Devices" in the reliability handbook, etc.), and ensure that usage conditions are within the ranges specified by Renesas Electronics with respect to maximum ratings, operating power supply voltage range, heat dissipation characteristics, installation, etc. Renesas Electronics disclaims any and all liability for any malfunctions, failure or accident arising out of the use of Renesas Electronics products outside of such specified ranges.
 7. Although Renesas Electronics endeavors to improve the quality and reliability of Renesas Electronics products, semiconductor products have specific characteristics, such as the occurrence of failure at a certain rate and malfunctions under certain use conditions. Unless designated as a high reliability product or a product for harsh environments in a Renesas Electronics data sheet or other Renesas Electronics document, Renesas Electronics products are not subject to radiation resistance design. You are responsible for implementing safety measures to guard against the possibility of bodily injury, injury or damage caused by fire, and/or danger to the public in the event of a failure or malfunction of Renesas Electronics products, such as safety design for hardware and software, including but not limited to redundancy, fire control and malfunction prevention, appropriate treatment for aging degradation or any other appropriate measures. Because the evaluation of microcomputer software alone is very difficult and impractical, you are responsible for evaluating the safety of the final products or systems manufactured by you.
 8. Please contact a Renesas Electronics sales office for details as to environmental matters such as the environmental compatibility of each Renesas Electronics product. You are responsible for carefully and sufficiently investigating applicable laws and regulations that regulate the inclusion or use of controlled substances, including without limitation, the EU RoHS Directive, and using Renesas Electronics products in compliance with all these applicable laws and regulations. Renesas Electronics disclaims any and all liability for damages or losses occurring as a result of your noncompliance with applicable laws and regulations.
 9. Renesas Electronics products and technologies shall not be used for or incorporated into any products or systems whose manufacture, use, or sale is prohibited under any applicable domestic or foreign laws or regulations. You shall comply with any applicable export control laws and regulations promulgated and administered by the governments of any countries asserting jurisdiction over the parties or transactions.
 10. It is the responsibility of the buyer or distributor of Renesas Electronics products, or any other party who distributes, disposes of, or otherwise sells or transfers the product to a third party, to notify such third party in advance of the contents and conditions set forth in this document.
 11. This document shall not be reprinted, reproduced or duplicated in any form, in whole or in part, without prior written consent of Renesas Electronics.
 12. Please contact a Renesas Electronics sales office if you have any questions regarding the information contained in this document or Renesas Electronics products.
- (Note 1) "Renesas Electronics" as used in this document means Renesas Electronics Corporation and also includes its directly or indirectly controlled subsidiaries.
(Note 2) "Renesas Electronics product(s)" means any product developed or manufactured by or for Renesas Electronics.

(Rev.4.0-1 November 2017)



SALES OFFICES

Renesas Electronics Corporation

<http://www.renesas.com>

Refer to "<http://www.renesas.com/>" for the latest and detailed information.

Renesas Electronics America Inc.
1001 Murphy Ranch Road, Milpitas, CA 95035, U.S.A.
Tel: +1-408-432-8888, Fax: +1-408-434-5351

Renesas Electronics Canada Limited
9251 Yonge Street, Suite 8309 Richmond Hill, Ontario Canada L4C 9T3
Tel: +1-905-237-2004

Renesas Electronics Europe Limited
Dukes Meadow, Millboard Road, Bourne End, Buckinghamshire, SL8 5FH, U.K.
Tel: +44-1628-651-700, Fax: +44-1628-651-804

Renesas Electronics Europe GmbH
Arcadiastrasse 10, 40472 Düsseldorf, Germany
Tel: +49-211-6503-0, Fax: +49-211-6503-1327

Renesas Electronics (China) Co., Ltd.
Room 1709 Quantum Plaza, No.27 ZhichunLu, Haidian District, Beijing, 100191 P. R. China
Tel: +86-10-8235-1155, Fax: +86-10-8235-7679

Renesas Electronics (Shanghai) Co., Ltd.
Unit 301, Tower A, Central Towers, 555 Langao Road, Putuo District, Shanghai, 200333 P. R. China
Tel: +86-21-2226-0888, Fax: +86-21-2226-0999

Renesas Electronics Hong Kong Limited
Unit 1601-1611, 16/F., Tower 2, Grand Century Place, 193 Prince Edward Road West, Mongkok, Kowloon, Hong Kong
Tel: +852-2265-6688, Fax: +852-2886-9022

Renesas Electronics Taiwan Co., Ltd.
13F, No. 363, Fu Shing North Road, Taipei 10543, Taiwan
Tel: +886-2-8175-9600, Fax: +886-2-8175-9670

Renesas Electronics Singapore Pte. Ltd.
80 Bendemeer Road, Unit #06-02 Hyflux Innovation Centre, Singapore 339949
Tel: +65-6213-0200, Fax: +65-6213-0300

Renesas Electronics Malaysia Sdn.Bhd.
Unit 1207, Block B, Menara Amcorp, Amcorp Trade Centre, No. 18, Jln Persiaran Barat, 46050 Petaling Jaya, Selangor Darul Ehsan, Malaysia
Tel: +60-3-7955-9390, Fax: +60-3-7955-9510

Renesas Electronics India Pvt. Ltd.
No.777C, 100 Feet Road, HAL 2nd Stage, Indiranagar, Bangalore 560 038, India
Tel: +91-80-67208700, Fax: +91-80-67208777

Renesas Electronics Korea Co., Ltd.
17F, KAMCO Yangjae Tower, 262, Gangnam-daero, Gangnam-gu, Seoul, 06265 Korea
Tel: +82-2-558-3737, Fax: +82-2-558-5338