

ISL8002BDEMO1Z

Demonstration Board User Guide

UG008
Rev 0.00
January 22, 2015

Description

The ISL8002BDEMO1Z kit is intended for use by individuals with requirements for point-of-load applications sourcing from 2.7V to 5.5V. The ISL8002BDEMO1Z board is used to demonstrate the performance of the ISL8002B low quiescent current mode converter.

The ISL8002B is offered in a 8 pin 2mmx2mm TDFN package with 1mm maximum height. The complete converter occupies less than 64mm² area.

Specifications

This board has been configured and optimized for the following operating conditions:

- V_{IN} = 2.7V to 5.5V
- V_{OUT} = 1.8V
- V_{TRACK} = 1.8V
- I_{OUT} maximum is 2A
- Switching frequency is 2MHz
- Up to 95% peak efficiency
- Selectable PFM or PWM operation option

Key Features

- Small, compact design
- V_{IN} range of 2.7V to 5.5V
- V_{OUT} adjustable from 0.6V up to 80% of V_{IN}
- I_{OUT} maximum is 2A
- External soft-start programmable
- Output tracking and sequencing
- Overcurrent and short-circuit protection
- Over-temperature/thermal protection

References

[ISL8002B Datasheet](#)

Ordering Information

PART NUMBER	DESCRIPTION
ISL8002BDEMO1Z	2A Demonstration Board

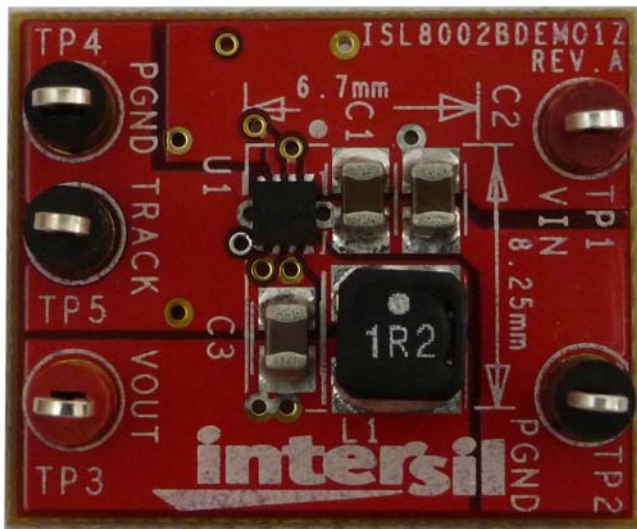

FIGURE 1. ISL8002BDEMO1Z TOP SIDE



FIGURE 2. ISL8002BDEMO1Z BOTTOM SIDE

What's Inside

The demonstration kit contains the following:

- The ISL8002BDEMO1Z
- [ISL8002B](#) Datasheet

Test Steps

If tracking feature is not used, connect SS/TR to VIN for 1ms internal soft-start and follow the test steps below:

1. Ensure that the circuit is correctly connected to the supply and loads prior to applying any power.
2. Connect the bias supply to VIN. Plus terminal to VIN (TP1) and negative return to PGND (TP2).
3. Connect the output load to VO (TP3), and the negative return to PGND (TP4).
4. Turn on the power supply.
5. Verify the output voltage is 1.8V for V_{OUT} .

Functional Description

The ISL8002BDEMO1Z provides a simple platform to evaluate performance of the ISL8002B.

The ISL8002B is a highly efficient, monolithic, synchronous step-down DC/DC converter that can deliver up to 2A of continuous output current from a 2.7V to 5.5V input supply. It uses peak current mode control architecture to allow very low duty cycle operation. The ISL8002B operates at a 2MHz switching frequency, thereby providing superior transient response and allowing for the use of small inductor.

The ISL8002B can be configured for either PFM (discontinuous conduction) or PWM (continuous conduction) operation at light load. PFM provides high efficiency by reducing switching losses at light loads and PWM reduces noise susceptibility and RF interference. Tied MODE pin to high for PWM or to Ground for PFM.

The ISL8002B can be programmable for external soft-start or output tracking and sequencing.

Adding a resistor divider from VIN to SS/TR (R_5 ; R_4) and a capacitor (C_6) from the SS/TR pin to ground determines the output ramp rate, maximum soft-start cap value is 1 μ F.

Adding a resistor divider across SS/TR can be use for outputs tracking. Populate R_3 and R_4 if Tracking feature is used. Ratio between R_1/R_2 should equal R_3/R_4 . Otherwise connect SS/TR to VIN for 1ms internal soft-start.

PCB Layout Guidelines

The PCB layout is a very important converter design step to make sure the designed converter works well. The power loop is composed of the output inductor L's, the output capacitor C_{OUT} , the PHASE's pins, and the PGND pin. It is necessary to make the power loop as small as possible and the connecting traces among them should be direct, short and wide. The switching node of the converter, the PHASE pins, and the traces connected to the node are very noisy, so keep the voltage feedback trace away from these noisy traces. The input capacitor should be placed as closely as possible to the VIN pin and the ground of the input and output capacitors should be connected as closely as possible. The heat of the IC is mainly dissipated through the thermal pad. Maximizing the copper area connected to the thermal pad is preferable. In addition, a solid ground plane is helpful for better EMI performance. It is recommended to add at least 4 vias ground connection within the pad for the best thermal relief.

ISL8002BDEMO1Z Schematic

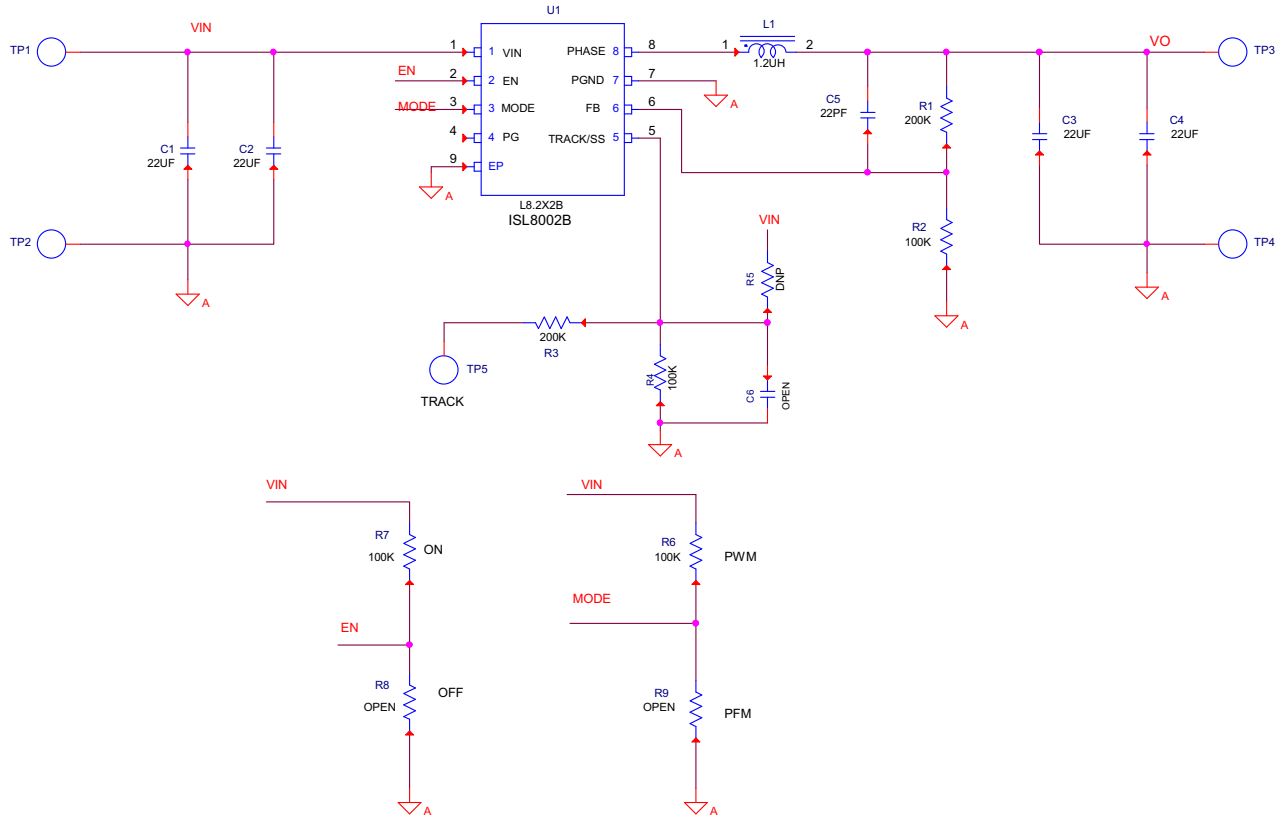

Bill of Materials

MANUFACTURER PART	QTY	UNITS	REFERENCE DESIGNATOR	DESCRIPTION	MANUFACTURER
C2012X5R0J226M	4	EA	C1-C4	CAP, SMD, 0805, 22 μ F, 6.3V, 20%, X5R, ROHS	TDK
GRM36COG220J050AQ	1	EA	C5	CAP, SMD, 0402, 22pF, 50V, 5%, NPO, ROHS	MURATA
	0	EA	C6	CAP, SMD, 0402, DNP-PLACE HOLDER, ROHS	
VLCF4028T-1R2N2R7-2	1	EA	L1	COIL-PWR INDUCTOR, WW, SMD, 4mm, 1.2 μ H, 30%, 2.7A, ROHS	TDK
5000	2	EA	TP1, TP3	CONN-MINI TEST PT, VERTICAL, RED, ROHS	KEYSTONE
5001	3	EA	TP2, TP4, TP5	CONN-MINI TEST PT, VERTICAL, BLK, ROHS	KEYSTONE
ISL8002BIRZ	1	EA	U1	IC-2A BUCK REGULATOR, 8P, TDFN, 2X2, ROHS	INTERSIL
ERJ2RKF1003	2	EA	R2, R4	RES, SMD, 0402, 100k, 1/16W, 1%, TF, ROHS	PANASONIC
MCR01MZPF2003	2	EA	R1, R3	RES, SMD, 0402, 200k, 1/16W, 1%, TF, ROHS	ROHM
	0	EA	R5	RES, SMD, 0402, DNP, DNP, DNP, TF, ROHS	
CR0603-10W-1003FT	2	EA	R6, R7	RES, SMD, 0603, 100k, 1/10W, 1%, TF, ROHS	VENKEL
	0	EA	R8, R9	RES, SMD, 0603, DNP-PLACE HOLDER, ROHS	

Board Layout

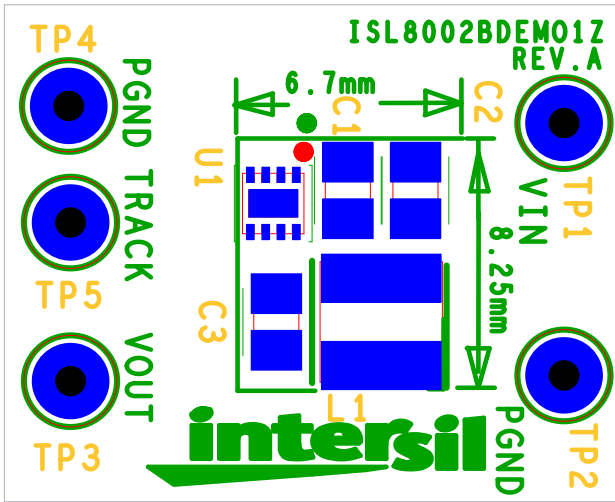

FIGURE 3. SILKSCREEN TOP

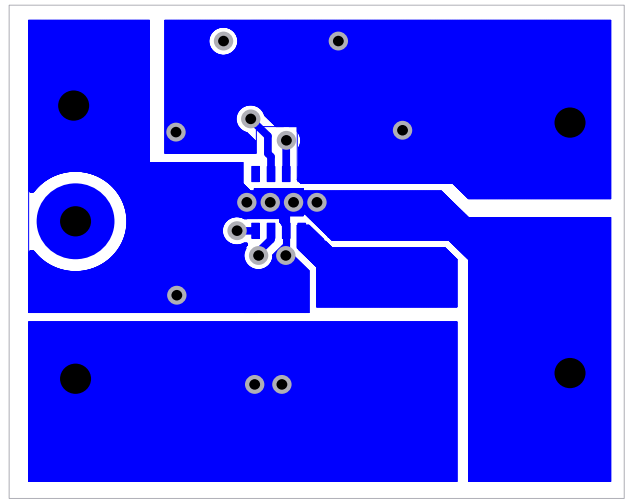

FIGURE 4. LAYER 1

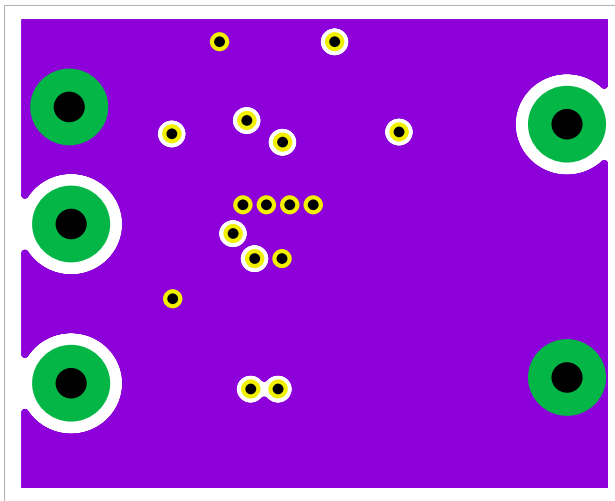

FIGURE 5. LAYER 2

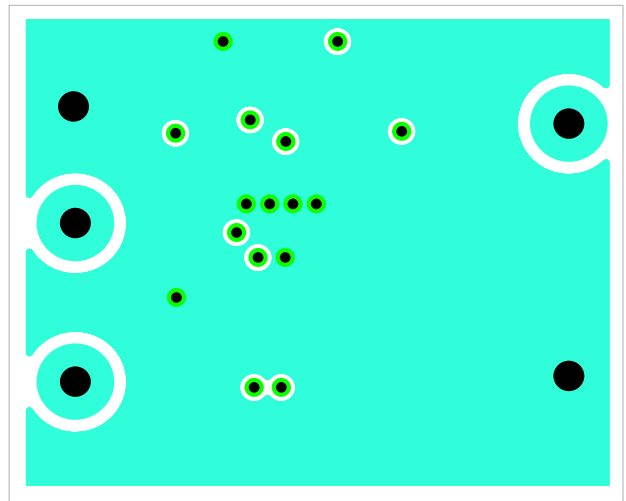

FIGURE 6. LAYER 3

Board Layout (Continued)

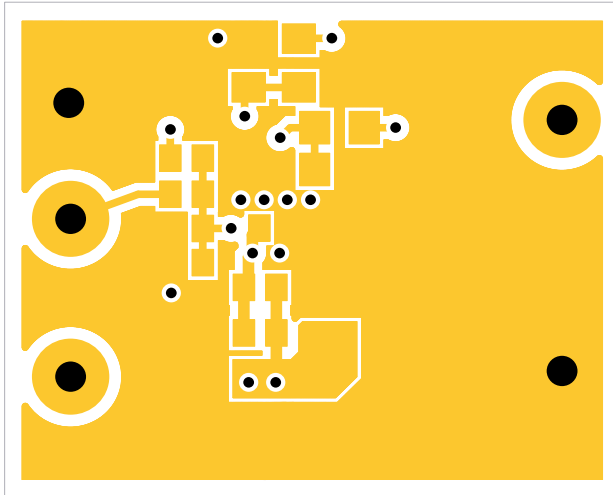

FIGURE 7. LAYER 4

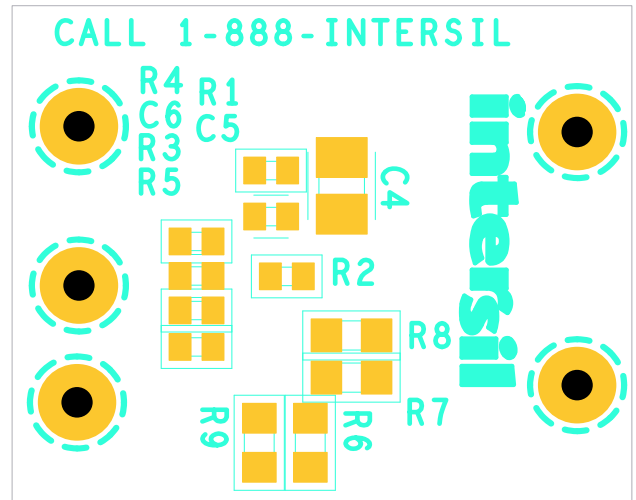

FIGURE 8. SILKSCREEN BOTTOM

Typical Performance Curves

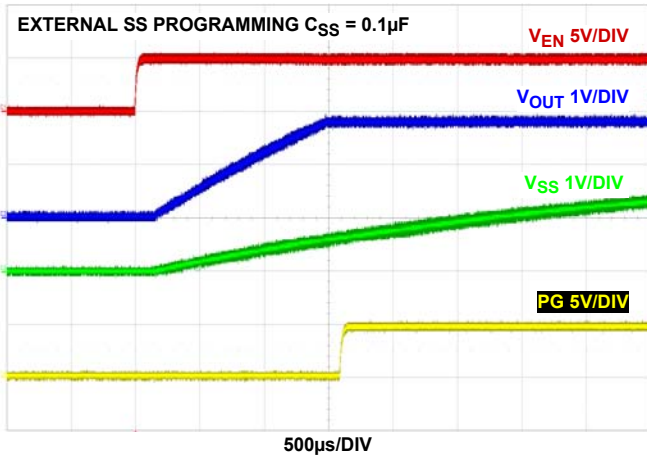

FIGURE 9. START-UP AT 2A LOAD
 $f_{\text{SW}} = 2\text{MHz}$, $V_{\text{IN}} = 5\text{V}$, MODE = PWM, $T_{\text{A}} = +25^{\circ}\text{C}$

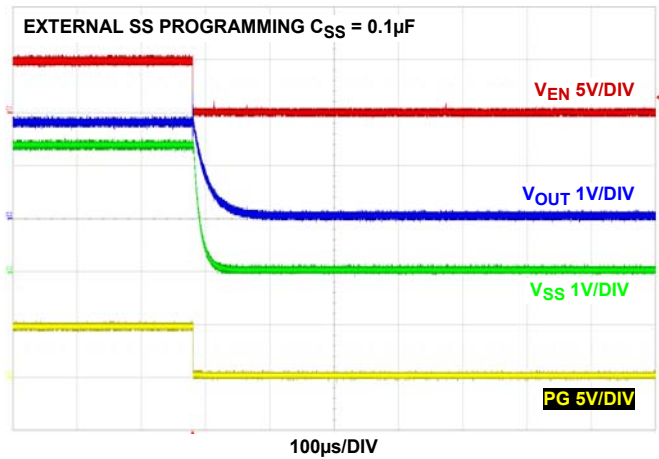

FIGURE 10. SHUTDOWN AT 2A LOAD
 $f_{\text{SW}} = 2\text{MHz}$, $V_{\text{IN}} = 5\text{V}$, MODE = PWM, $T_{\text{A}} = +25^{\circ}\text{C}$

Typical Performance Curves (Continued)

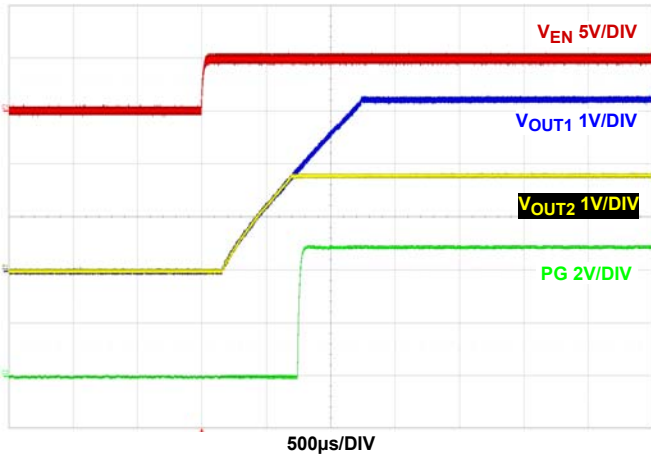

FIGURE 11. COINCIDENTAL VOLTAGE TRACKING START-UP AT FULL LOAD, $V_{IN} = 5V$, MODE = PWM, $T_A = +25^\circ C$

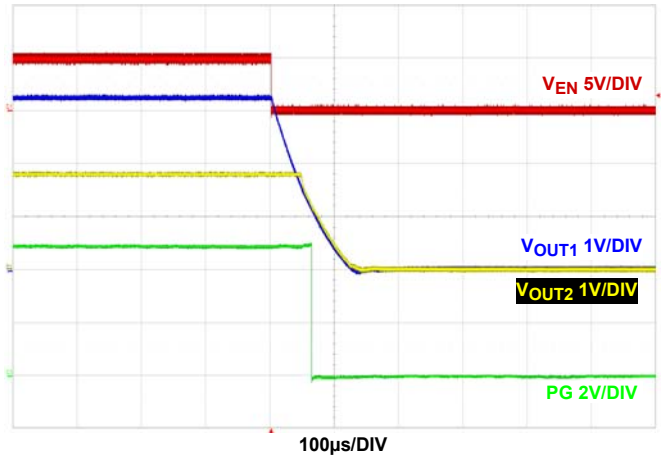

FIGURE 12. COINCIDENTAL VOLTAGE TRACKING SHUTDOWN AT FULL LOAD, $V_{IN} = 5V$, MODE = PWM, $T_A = +25^\circ C$

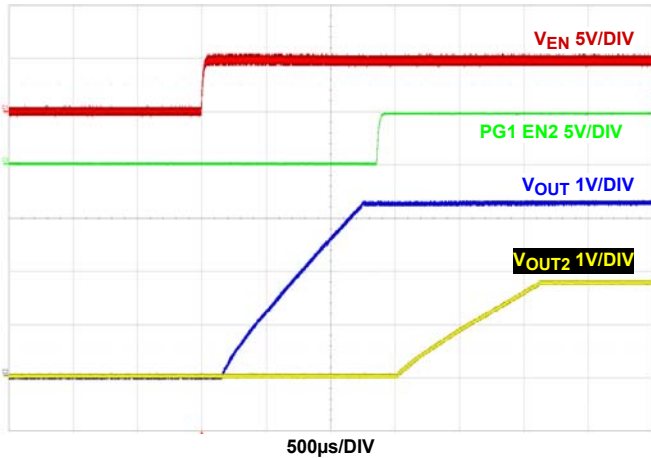

FIGURE 13. SEQUENTIAL START-UP USING EN AND PG AT FULL LOAD, $V_{IN} = 5V$, MODE = PWM, $T_A = +25^\circ C$

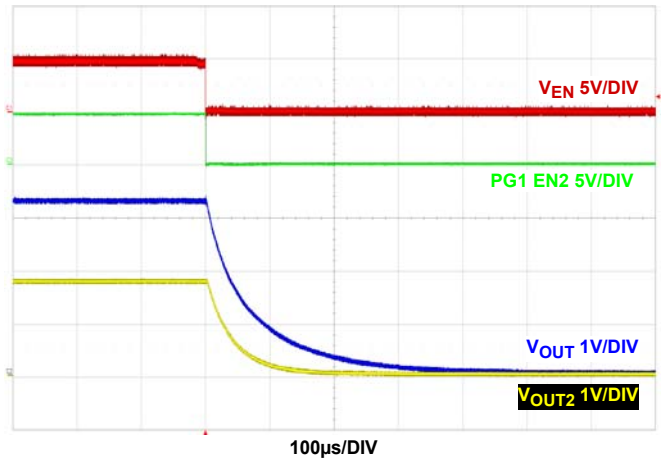

FIGURE 14. SEQUENTIAL SHUTDOWN USING EN AND PG AT FULL LOAD, $V_{IN} = 5V$, MODE = PWM, $T_A = +25^\circ C$

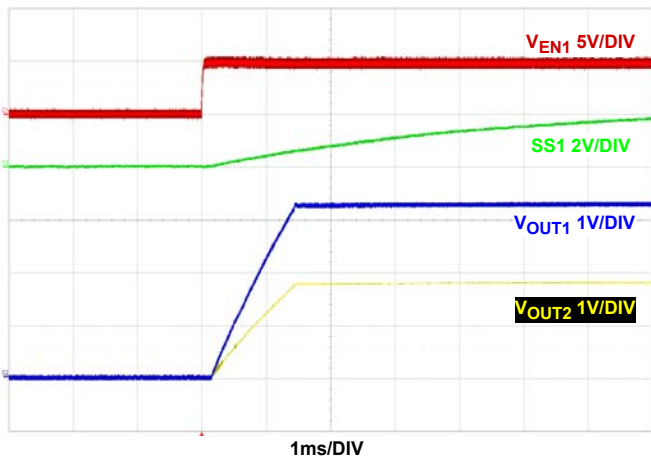

FIGURE 15. RATIOMETRIC START-UP WITH V_{OUT1} LEADING V_{OUT2} AT FULL LOAD, $V_{IN} = 5V$, MODE = PWM, $T_A = +25^\circ C$

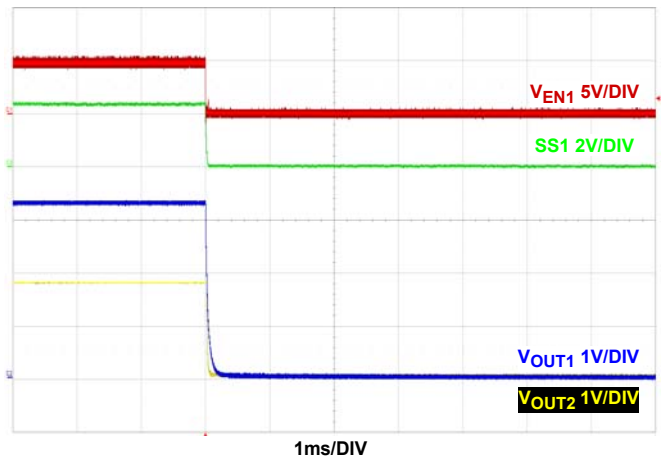

FIGURE 16. RATIOMETRIC SHUTDOWN WITH V_{OUT1} LEADING V_{OUT2} AT FULL LOAD, $V_{IN} = 5V$, MODE = PWM, $T_A = +25^\circ C$

Notice

1. Descriptions of circuits, software and other related information in this document are provided only to illustrate the operation of semiconductor products and application examples. You are fully responsible for the incorporation or any other use of the circuits, software, and information in the design of your product or system. Renesas Electronics disclaims any and all liability for any losses and damages incurred by you or third parties arising from the use of these circuits, software, or information.
2. Renesas Electronics hereby expressly disclaims any warranties against and liability for infringement or any other claims involving patents, copyrights, or other intellectual property rights of third parties, by or arising from the use of Renesas Electronics products or technical information described in this document, including but not limited to, the product data, drawings, charts, programs, algorithms, and application examples.
3. No license, express, implied or otherwise, is granted hereby under any patents, copyrights or other intellectual property rights of Renesas Electronics or others.
4. You shall not alter, modify, copy, or reverse engineer any Renesas Electronics product, whether in whole or in part. Renesas Electronics disclaims any and all liability for any losses or damages incurred by you or third parties arising from such alteration, modification, copying or reverse engineering.
5. Renesas Electronics products are classified according to the following two quality grades: "Standard" and "High Quality". The intended applications for each Renesas Electronics product depends on the product's quality grade, as indicated below.
"Standard": Computers; office equipment; communications equipment; test and measurement equipment; audio and visual equipment; home electronic appliances; machine tools; personal electronic equipment; industrial robots; etc.
"High Quality": Transportation equipment (automobiles, trains, ships, etc.); traffic control (traffic lights); large-scale communication equipment; key financial terminal systems; safety control equipment; etc.
Unless expressly designated as a high reliability product or a product for harsh environments in a Renesas Electronics data sheet or other Renesas Electronics document, Renesas Electronics products are not intended or authorized for use in products or systems that may pose a direct threat to human life or bodily injury (artificial life support devices or systems; surgical implantations; etc.), or may cause serious property damage (space system; undersea repeaters; nuclear power control systems; aircraft control systems; key plant systems; military equipment; etc.). Renesas Electronics disclaims any and all liability for any damages or losses incurred by you or any third parties arising from the use of any Renesas Electronics product that is inconsistent with any Renesas Electronics data sheet, user's manual or other Renesas Electronics document.
6. When using Renesas Electronics products, refer to the latest product information (data sheets, user's manuals, application notes, "General Notes for Handling and Using Semiconductor Devices" in the reliability handbook, etc.), and ensure that usage conditions are within the ranges specified by Renesas Electronics with respect to maximum ratings, operating power supply voltage range, heat dissipation characteristics, installation, etc. Renesas Electronics disclaims any and all liability for any malfunctions, failure or accident arising out of the use of Renesas Electronics products outside of such specified ranges.
7. Although Renesas Electronics endeavors to improve the quality and reliability of Renesas Electronics products, semiconductor products have specific characteristics, such as the occurrence of failure at a certain rate and malfunctions under certain use conditions. Unless designated as a high reliability product or a product for harsh environments in a Renesas Electronics data sheet or other Renesas Electronics document, Renesas Electronics products are not subject to radiation resistance design. You are responsible for implementing safety measures to guard against the possibility of bodily injury, injury or damage caused by fire, and/or danger to the public in the event of a failure or malfunction of Renesas Electronics products, such as safety design for hardware and software, including but not limited to redundancy, fire control and malfunction prevention, appropriate treatment for aging degradation or any other appropriate measures. Because the evaluation of microcomputer software alone is very difficult and impractical, you are responsible for evaluating the safety of the final products or systems manufactured by you.
8. Please contact a Renesas Electronics sales office for details as to environmental matters such as the environmental compatibility of each Renesas Electronics product. You are responsible for carefully and sufficiently investigating applicable laws and regulations that regulate the inclusion or use of controlled substances, including without limitation, the EU RoHS Directive, and using Renesas Electronics products in compliance with all these applicable laws and regulations. Renesas Electronics disclaims any and all liability for damages or losses occurring as a result of your noncompliance with applicable laws and regulations.
9. Renesas Electronics products and technologies shall not be used for or incorporated into any products or systems whose manufacture, use, or sale is prohibited under any applicable domestic or foreign laws or regulations. You shall comply with any applicable export control laws and regulations promulgated and administered by the governments of any countries asserting jurisdiction over the parties or transactions.
10. It is the responsibility of the buyer or distributor of Renesas Electronics products, or any other party who distributes, disposes of, or otherwise sells or transfers the product to a third party, to notify such third party in advance of the contents and conditions set forth in this document.
11. This document shall not be reprinted, reproduced or duplicated in any form, in whole or in part, without prior written consent of Renesas Electronics.
12. Please contact a Renesas Electronics sales office if you have any questions regarding the information contained in this document or Renesas Electronics products.
(Note 1) "Renesas Electronics" as used in this document means Renesas Electronics Corporation and also includes its directly or indirectly controlled subsidiaries.
(Note 2) "Renesas Electronics product(s)" means any product developed or manufactured by or for Renesas Electronics.

(Rev.4.0-1 November 2017)



SALES OFFICES

Renesas Electronics Corporation

<http://www.renesas.com>

Refer to "<http://www.renesas.com/>" for the latest and detailed information.

Renesas Electronics America Inc.
1001 Murphy Ranch Road, Milpitas, CA 95035, U.S.A.
Tel: +1-408-432-8888, Fax: +1-408-434-5351

Renesas Electronics Canada Limited
9251 Yonge Street, Suite 8309 Richmond Hill, Ontario Canada L4C 9T3
Tel: +1-905-237-2004

Renesas Electronics Europe Limited
Dukes Meadow, Millboard Road, Bourne End, Buckinghamshire, SL8 5FH, U.K.
Tel: +44-1628-651-700, Fax: +44-1628-651-804

Renesas Electronics Europe GmbH
Arcadiastrasse 10, 40472 Düsseldorf, Germany
Tel: +49-211-6503-0, Fax: +49-211-6503-1327

Renesas Electronics (China) Co., Ltd.
Room 1709 Quantum Plaza, No.27 ZhichunLu, Haidian District, Beijing, 100191 P. R. China
Tel: +86-10-8235-1155, Fax: +86-10-8235-7679

Renesas Electronics (Shanghai) Co., Ltd.
Unit 301, Tower A, Central Towers, 555 Langao Road, Putuo District, Shanghai, 200333 P. R. China
Tel: +86-21-2226-0888, Fax: +86-21-2226-0999

Renesas Electronics Hong Kong Limited
Unit 1601-1611, 16/F., Tower 2, Grand Century Place, 193 Prince Edward Road West, Mongkok, Kowloon, Hong Kong
Tel: +852-2265-6688, Fax: +852-2886-9022

Renesas Electronics Taiwan Co., Ltd.
13F, No. 363, Fu Shing North Road, Taipei 10543, Taiwan
Tel: +886-2-8175-9600, Fax: +886-2-8175-9670

Renesas Electronics Singapore Pte. Ltd.
80 Bendemeer Road, Unit #06-02 Hyflux Innovation Centre, Singapore 339949
Tel: +65-6213-0200, Fax: +65-6213-0300

Renesas Electronics Malaysia Sdn.Bhd.
Unit 1207, Block B, Menara Amcorp, Amcorp Trade Centre, No. 18, Jln Persiaran Barat, 46050 Petaling Jaya, Selangor Darul Ehsan, Malaysia
Tel: +60-3-7955-9390, Fax: +60-3-7955-9510

Renesas Electronics India Pvt. Ltd.
No.777C, 100 Feet Road, HAL 2nd Stage, Indiranagar, Bangalore 560 038, India
Tel: +91-80-67208700, Fax: +91-80-67208777

Renesas Electronics Korea Co., Ltd.
17F, KAMCO Yangjae Tower, 262, Gangnam-daero, Gangnam-gu, Seoul, 06265 Korea
Tel: +82-2-558-3737, Fax: +82-2-558-5338