

ISL78264EVAL1Z

User's Manual: Evaluation Board

Automotive

All information contained in these materials, including products and product specifications, represents information on the product at the time of publication and is subject to change by Renesas Electronics Corp. without notice. Please review the latest information published by Renesas Electronics Corp. through various means, including the Renesas Electronics Corp. website (<http://www.renesas.com>).

ISL78264EVAL1Z

Evaluation Board

The ISL78264EVAL1Z board demonstrates the two-channel synchronous buck converter operation of the [ISL78264](#) in which the converters have 180 phase shift to minimize input capacitor stress. It illustrates the high efficiency of synchronous buck operation and all the features of the IC including overcurrent protection, overvoltage and undervoltage protection, and power-good indication for each channel.

Key Features

- V_{IN} operating range: 3.75V to 42V
- Selectable Forced PWM or ECM Mode with $I_q = 6\mu A$ (one channel)
- Programmable switching frequency: 200kHz to 2.2MHz
- Dropout mode for high duty-cycle operation
- 20ns on-times for low duty-cycle operation
- External synchronization
- Programmable spread spectrum clocking
- 180° phase shift between channels
- 2A Sourcing/3A sinking MOSFET drivers
- Boot UVLO and programmable boot refresh time
- Extensive protection mechanisms for OV/UV/OC/OT
- Monitor test points for key signals

Specifications

This board is configured and optimized for the following operating conditions. See [“Operating Range” on page 4](#) for more detailed descriptions.

- $V_{IN_TYP} = 12-14V$
- $V_{IN_MAX} = 42V$ (typical)
- $V_{OUT1} = 5V$ (up to 10A)
- $V_{OUT2} = 3.3V$ (up to 10A)
- $f_{SW} = 2.2MHz$

Ordering Information

Part Number	Description
ISL78264EVAL1Z	ISL78264 evaluation board

Related Literature

For a full list of related documents, visit our website:

- [ISL78264](#) device page

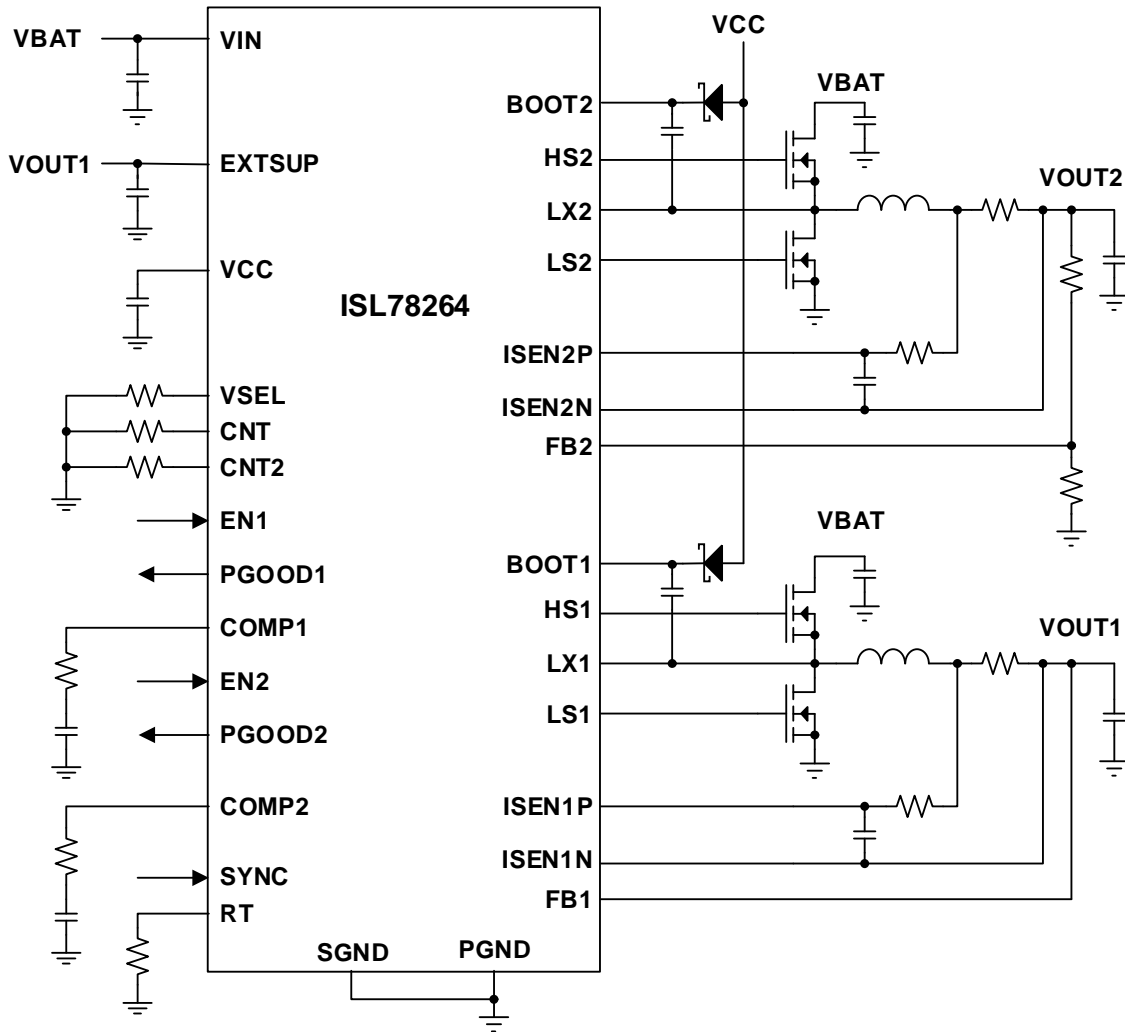

Figure 1. ISL78264EVAL1Z Block Diagram

1. Functional Description

The ISL78264EVAL1Z evaluation board photos are shown in [Figures 2](#) and [3](#). The board supports a quick evaluation of various features of the ISL78264 while demonstrating a power solution providing two rail voltages with very high efficiency over a wide load range. The ISL78264EVAL1Z demonstrates the feature set of the ISL78264 supporting automotive applications powered from a car battery.

1.1 Recommended Equipment

- VBAT (V_{IN} supply): 50V power supply with 20A source current capability
- Output Loads: Two loads capable of >10A
- Digital Multimeters (DMM) and/or oscilloscope to monitor various voltages

1.2 Operating Range

- Enable operation
 - S1 and S2 control EN1 and EN2 for Converter 1 and Converter 2, respectively.
 - EN1 has a 100k Ω resistor to V_{IN} to allow auto-start of Channel 1 when V_{IN} is applied.
 - EN2 has a 10k Ω pull-up resistor to V_{CC} , requiring V_{CC} to be present for Channel 2 to be enabled.
 - The converters are allowed to start when the input voltage (V_{IN}), rises above 5.65V (typical).
- V_{IN_MIN} = 6V or lower
 - The board shuts down when V_{CC} falls below 4V (typical)
- V_{IN_TYP} = 12V
- V_{IN_MAX} = 42V (typical)
- I_{OUT_MAX} = 10A
- f_{SW} = 2.2MHz as selected with R16 = 6.81k Ω
- The board is set in ECM mode by default with J10 (FCCM) open, which allows R46 (100k Ω) to pull the SYNC pin low.
- The board is set to connect 5V output of Channel 1 to EXTSUP (U1-20) with a jumper shorting Pins 2-3 of J15 to provide an efficient 5V source for control and gate drive power
- Switches S3 and S4 allow setting the operating configurations as detailed in the datasheet
 - S3 should have position 8 **ON** to connect VSEL (U1-3) to R31 (75k Ω) to ground to select Converter 1 as 5V fixed voltage
 - S3 should have position 3 **ON** to connect VSEL (U1-1) to R26 (54.9k Ω) to ground to select Boot refresh time of 300ns
 - S4 should have position 3 **ON** to connect VSEL (U1-3) to R34 (14.7k Ω) to ground to select minimum dead time and Spread Spectrum **OFF**

1.3 External Connections and Setup Before Start-Up

1. Connect the V_{IN} power supply between VBAT (J1) and GND (J2). Before typical start-up, set the V_{IN} power supply voltage to 12V. The power supply output should remain off before start-up.
2. For initial startup position S1 and S2 in **OFF** position.
3. Connect separate electronic loads between VOUT1 (J6) and GND (J5), and VOUT2 (J3) and GND (J4). Set the electronic load to 0A for the first start-up. The load should remain off before start-up.
4. Place the DMMs or oscilloscope appropriately where the signals are to be measured.
5. Switch S1 to **ON** position to enable VOUT1.
6. Switch S2 to **ON** position to enable VOUT2.

2. PCB Layout Guidelines

2.1 ISL78264EVAL1Z Evaluation Board

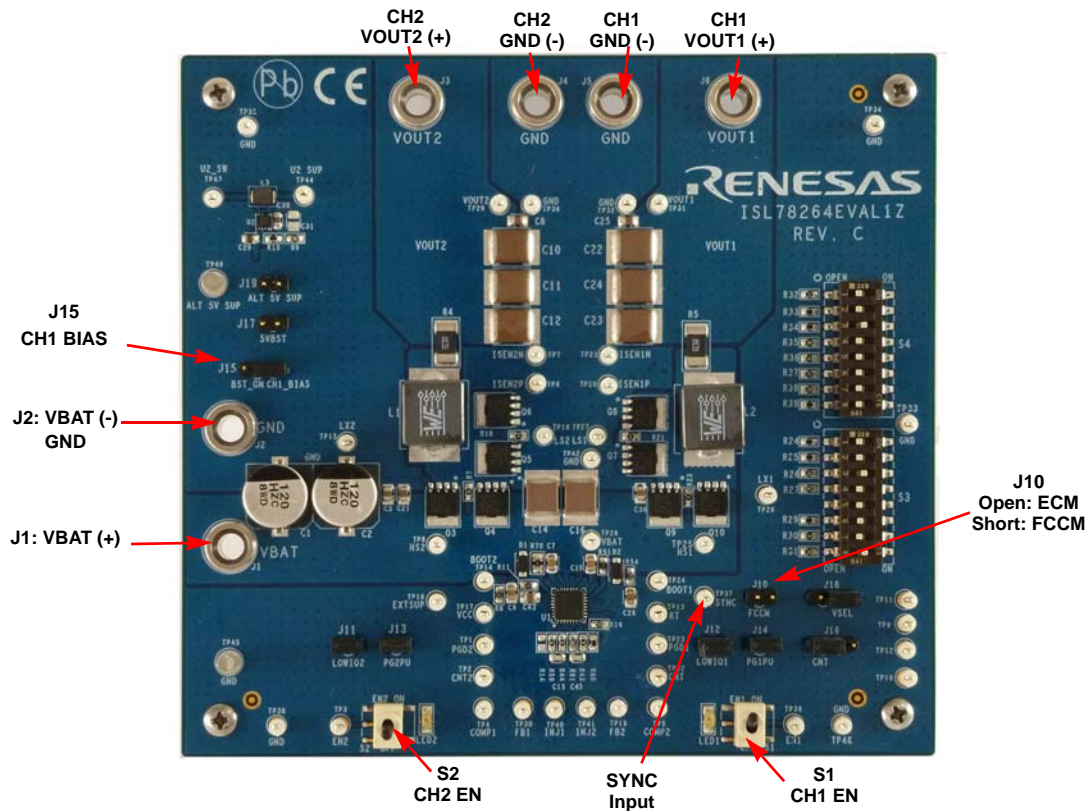

Figure 2. ISL78264EVAL1Z Evaluation Board (Top)

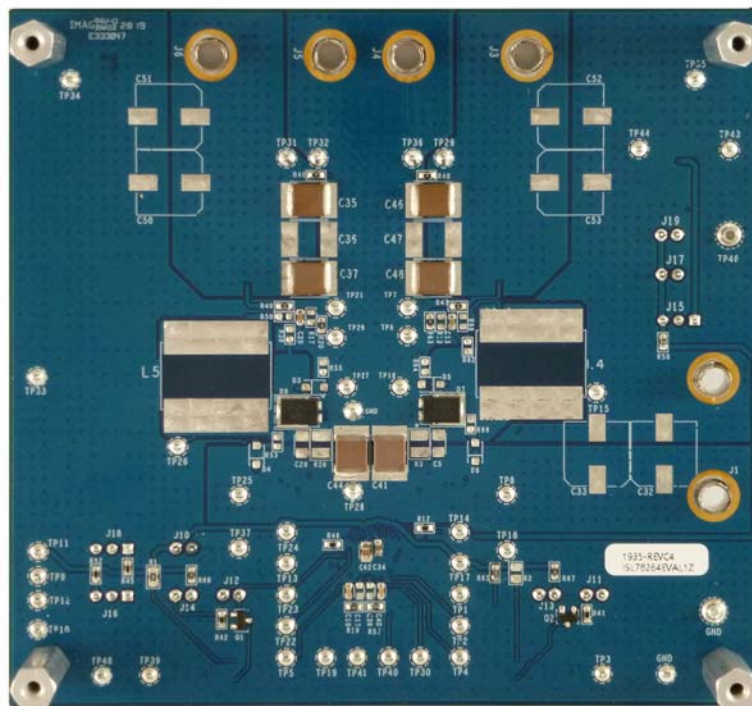

Figure 3. ISL78264EVAL1Z Evaluation Board (Bottom)

2.2 ISL720xCSEHEVAL1Z Circuit Schematic

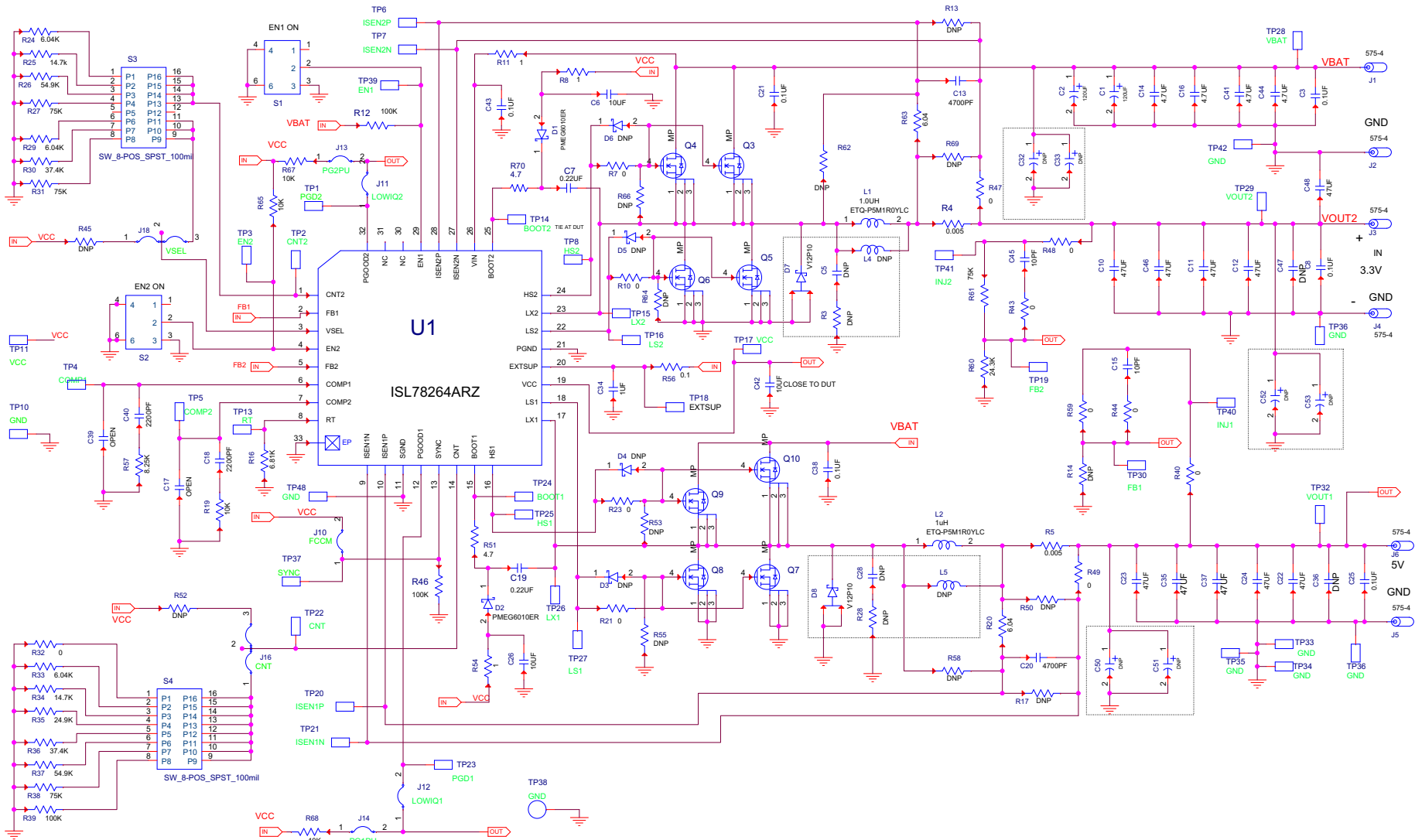

Figure 4. Schematic - Page 1 of 2

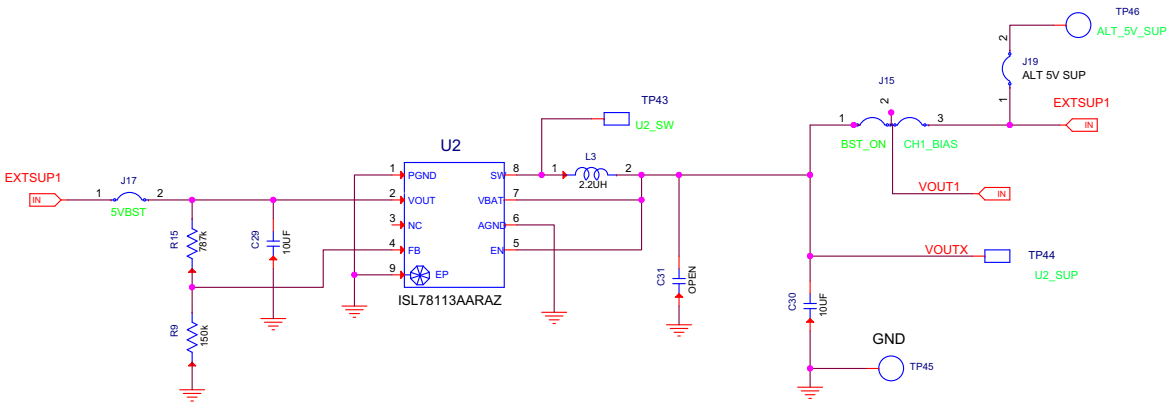
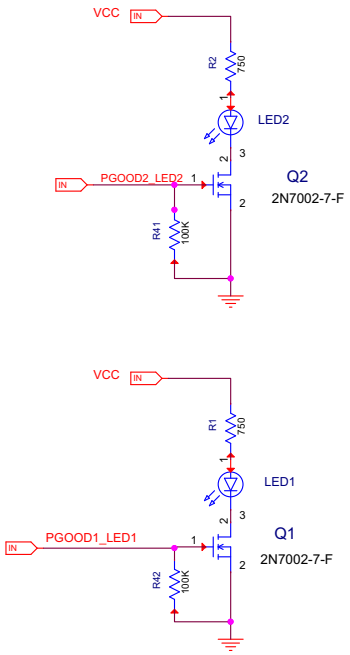

Figure 5. Schematic - Page 2 of 2

Table 1. Connector/Monitor Pin Descriptions

Connector/ Test Point	Signal Name	Description
J1	VBAT	VIN supply connection for positive input.
J2	GND	VIN supply GND connection.
J3	VOOUT2	VOOUT2 connection to load.
J4	GND	VOOUT2 GND connection to load.
J5	GND	VOOUT1 GND connection to load.
J6	VOOUT1	VOOUT1 connection to load.
J10	FCCM	Jumper open to allow ECM operation; install to force FCCM.
J11	LOWIQ2	Jumper normally installed for PGOOD2; open to measure low I _Q .
J12	LOWIQ1	Jumper normally installed for PGOOD1; open to measure low I _Q .
J13	PG2PU	Jumper normally installed for PGOOD2; open to measure low I _Q .
J14	PG1PU	Jumper normally installed for PGOOD1; open to measure low I _Q .
J15	BST_ON/CH1_BIAS	Jumper normally connects VOOUT1 to EXTSUP1.
J16	CNT	Jumper installed to connect S4 and CNT configuration resistor.
J17	5VBST	Jumper normally open; can be used to connect U2-2 to EXTSUP1.
J18	VSEL	Jumper installed to connect S3 and VSEL configuration resistor.
J19	ALT_5V_SUP	Jumper normally open; can be installed to use alternate bias supply.
TP1	PGD2	Test point to monitor PGOOD2 on pin U1-32.
TP2	CNT2	Test point to monitor CNT2 on pin U1-14.
TP3	EN2	Test point to monitor EN2 on pin U1-4.
TP4	COMP1	Test point to monitor COMP1 on pin U1-6.
TP5	COMP2	Test point to monitor COMP2 on pin U1-7.
TP6	ISEN2P	Test point to monitor ISEN2P on pin U1-28.
TP7	ISEN2N	Test point to monitor ISEN2N on pin U1-27.
TP8	HS2	Test point to monitor HS2 on pin U1-24.
TP10	GND	
TP11	VCC	Test point to monitor V _{CC} .
TP13	RT	Test point to monitor RT on pin U1-8.
TP14	BOOT2	Test point to monitor BOOT2 on pin U1-25.
TP15	LX2	Test point to monitor BOOT2 on pin U1-23.
TP16	LS2	Test point to monitor LS2 on pin U1-22.
TP17	VCC	Test point to monitor V _{cc} on pin U1-19.
TP18	EXTSUP	Test point to monitor EXTSUP on pin U1-20.
TP19	FB2	Test point to monitor FB2 on pin U1-5.
TP20	ISEN1P	Test point to monitor ISEN1P on pin U1-10.
TP21	ISEN1N	Test point to monitor ISEN1N on pin U1-9.
TP22	CNT	Test point to monitor CNT on pin U1-14.
TP23	PGD1	Test point to monitor PGOOD1 on pin U1-12.
TP24	BOOT1	Test point to monitor BOOT1 on pin U1-15.
TP25	HS1	Test point to monitor HS1 on pin U1-16.
TP26	LX1	Test point to monitor LX1 on pin U1-19.
TP27	LS1	Test point to monitor LS1 on pin U1-18

Table 1. Connector/Monitor Pin Descriptions (Continued)

Connector/ Test Point	Signal Name	Description
TP28	VBAT	Test point to monitor VBAT supply voltage.
TP29	VOOUT2	Test point to monitor VOOUT2 voltage.
TP30	FB1	Test point to monitor FB1 on pin U1-2.
TP32	VOOUT1	Test point to monitor VOOUT1 voltage.
TP10, TP33, TP34, TP35, TP36, TP38, TP42, TP45, TP48	GND	Test point to connect to GND.
TP37	SYNC	Test point to monitor SYNC pin U1-13.
TP39	EN1	Test point to monitor EN1 pin U1-29.
TP40	INJ1	Test point to inject signal for Channel 1 control loop evaluation.
TP41	INJ2	Test point to inject signal for Channel 2 control loop evaluation.
TP43	U2_SW	Test point to monitor voltage on pin U2-8.
TP44	U2_SUP	Test point to monitor voltage on pin U2-7.
TP46	ALT_5V_SUP	Test point to monitor voltage on J19-2.

2.3 Bill of Materials

Reference Designator	Description	Manufacturer	Manufacturer Part
	PWB-PCB, ISL78264EVAL1Z, REVC, ROHS	Imagineering	ISL78264EVAL1ZREVCPCB
C34	CAP, SMD, 0603, 1.0 μ F, 16V, 10%, X7R, ROHS	TDK	C1608X7R1C105K
C3, C8, C21, C25, C38, C43	CAP-AEC-Q200, SMD, 0805, 0.1 μ F, 100V, 10%, X7R, ROHS	TDK	CGA4J2X7R2A104K125AA
C14, C16, C41, C44	CAP-AEC-Q200, SMD, 2220, 4.7 μ F, 100V, 10%, X7R, ROHS	TDK	CGA9N2X7R2A475K230KA
C10, C11, C12, C22, C23, C24, C35, C37, C46, C48	CAP-AEC-Q200, SMD, 2220, 47 μ F, 16V, 20%, X7R, ROHS	TDK	CGA9N3X7R1C476M230KB
C6, C26, C42	CAP-AEC-Q200, SMD, 0805, 10 μ F, 10V, 10%, X7R, ROHS	Murata	GCJ21BR71A106KE01L
C13, C20	CAP-AEC-Q200, SMD, 0603, 4700pF, 100V, 10%, X7R, ROHS	Murata	GCM188R72A472KA37D
C15, C45	CAP, SMD, 0603, 10pF, 50V, 10%, NP0, ROHS	Venkel	C0603COG500-100KDE
C29, C30	CAP, SMD, 0603, 10 μ F, 16V, 10%, X5R, ROHS	Murata	GRM188R61C106KAALD
C18, C40	CAP, SMD, 0603, 2200pF, 100V, 10%, X7R, ROHS	Venkel	C0603X7R101-222KNE
C17, C39	CAP, SMD, 0603, DNP-PLACE HOLDER, ROHS		
C7, C19,	CAP, SMD, 0805, 0.22 μ F, 100V, 10%, X7R, ROHS	Kemet	C0805C224K1RACAUTO
L1, L2	COIL-PWR INDUCTOR, SMD, 10.9x10, 0, 1 μ H, 20A, 20%, 2.65m Ω , ROHS	Würth Elektronik	7443330100
C1, C2	CAP-AEC-Q200, SMD, 10.3mm, 120 μ F, 50V, 20%, 28m Ω , ROHS	Panasonic	EEH-ZC1H121P
L3	COIL-INDUCTOR, SMD, 1210, 2.2 μ H, 30%, 1.85A, 76.8m Ω , WW, ROHS	Murata	LQH32PN2R2NNCL
TP45, TP46	CONN-TURRET, TERMINAL POST, TH, ROHS	Keystone	1514-2
TP1-TP8, TP10, TP11, TP13-TP44, TP48	CONN-MINI TEST POINT, VERTICAL, WHITE, ROHS	Keystone	5002
J1, J2, J3, J4, J5, J6	CONN-JACK, MINI BANANA, 0.175 PLUG, NICKEL/BRASS, ROHS	Keystone	575-4
J10, J11, J12, J13, J14, J17, J19	CONN-HEADER, 1x2, BRKAWY 1x36, 2.54mm, ROHS	BERG/FCI	68000-236HLF

Reference Designator	Description	Manufacturer	Manufacturer Part
J15, J16, J18	CONN-HEADER, 1x3, BREAKAWY 1x36, 2.54mm, ROHS	BERG/FCI	68000-236HLF
J11, J12, J13, J14, J15-Pins 2-3, J16-Pins 1-2, J18-Pins 2-3	CONN-JUMPER, SHORTING, 2PIN, BLACK, GOLD, ROHS	Sullins	SPC02SYAN
D1, D2	DIODE-SCHOTTKY, SMD, 2P, SOD123W, 60V, 1A, Vf = 530mV at 1A, ROHS	Nexperia	PMEG6010ER, 115
D7, D8	DIODE-SCHOTTKY, SMD, TO-277A(SMPC), 100V, 12A, ROHS	Vishay	V12P10-M3/86A
LED1, LED2	LED, SMD, 1206, GREEN, 75mW, 3mcd, 567nm, ROHS	Dialight	597-3311-407NF
U2	IC-SYNCHRONOUS BOOST CONVERTER, 8P, DFN, ROHS	Renesas	ISL78113AARAZ
U1	IC-DUAL BUCK CONTROLLER, 32P, WFQFN, 5x5, ROHS	Renesas	ISL78264ARZ
Q1, Q2	TRANSISTOR, N-CHANNEL, 3LD, SOT-23, 60V, 115mA, ROHS	Diodes, Inc.	2N7002-7-F
Q3-Q10	TRANSISTOR-MOS, N-CHANNEL, SMD, 4P, LPAK, 40V, 33A, 18.1mΩ, ROHS	NXP	BUK9Y21-40E, 115
R20, R63	RES-AEC-Q200, SMD, 0603, 6.04Ω, 1/10W, 1%, TF, ROHS	Vishay/Dale	CRCW06036R04FKEA
R56	RES-AEC-Q200, SMD, 0603, 0.1Ω, 1/4W, 1%, TF, CURR.SENSE, ROHS	Panasonic	ERJ-3BSFR10V
R8, R11, R54	RES, SMD, 0603, 1Ω, 1/10W, 1%, TF, ROHS	Panasonic	ERJ-3RQF1R0V
R51, R70	RES, SMD, 0603, 4.7Ω, 1/10W, 1%, TF, ROHS	Venkel	CR0603-10W-4R70FT
R7, R10, R21, R23, R32, R40, R43, R44, R47, R48, R49, R59	RES, SMD, 0603, 0Ω, 1/10W, TF, ROHS	Venkel	CR0603-10W-000T
R19, R65, R67, R68	RES, SMD, 0603, 10k, 1/10W, 1%, TF, ROHS	Venkel	CR0603-10W-1002FT
R12, R39, R41, R42, R46	RES, SMD, 0603, 100k, 1/10W, 1%, TF, ROHS	Venkel	CR0603-10W-1003FT
R25, R34	RES, SMD, 0603, 14.7k, 1/10W, 1%, TF, ROHS	Venkel	CR0603-10W-1472FT
R9	RES, SMD, 0603, 150k, 1/10W, 1%, TF, ROHS	Yageo	RC0603FR-07150KL
R60	RES, SMD, 0603, 24.3k, 1/10W, 1%, TF, ROHS	Yageo	RC0603FR-0724K3L
R35	RES, SMD, 0603, 24.9k, 1/10W, 1%, TF, ROHS	Panasonic	ERJ-3EKF2492V
R30, R36	RES, SMD, 0603, 37.4k, 1/10W, 1%, TF, ROHS	Yageo	RC0603FR-0737K4L
R26, R37	RES, SMD, 0603, 54.9k, 1/10W, 1%, TF, ROHS	Panasonic	ERJ-3EKF5492V
R24, R29, R33	RES, SMD, 0603, 6.04k, 1/10W, 1%, TF, ROHS	Venkel	CR0603-10W-6041FT
R16	RES, SMD, 0603, 6.81k, 1/10W, 1%, TF, ROHS	Yageo	RC0603FR-076K81L
R27, R31, R38, R61	RES, SMD, 0603, 75k, 1/10W, 1%, TF, ROHS	Venkel	CR0603-10W-7502FT
R15	RES, SMD, 0603, 787k, 1/10W, 1%, TF, ROHS	Yageo	RC0603FR-07787KL
R57	RES, SMD, 0603, 8.25kΩm, 1/10W, 1%, TF, ROHS	Panasonic	ERJ-3EKF8251V
R13, R14, R17, R50, R53, R55, R58, R62, R64, R66, R69	RES, SMD, 0603, DNP-PLACE HOLDER, ROHS		
R1, R2	RES, SMD, 0805, 750Ω, 1/8W, 1%, TF, ROHS	Panasonic	ERJ-6ENF7500V
R3, R28	RES, SMD, 1210, DNP, DNP, DNP, TF, ROHS		
R4, R5	RES-AEC-Q200, SMD, 2512, 0.005Ω, 2W, 1%, CURR.SENSE, MF, ROHS	Vishay/Dale	WSL25125L000FEA18
S3, S4	SWITCH-SLIDE DIP, SMD, 8POS, SPST, 100mA, 12V, SEALED, ROHS	CTS Electronic Components	219-8MSTR
S1, S2	SWITCH-TOGGLE, SMD, 6PIN, SPDT, 2POS, ON-NONE-ON, ROHS	ITT Industries /C&K Division	GT11MSCBE

2.4 Board Layout

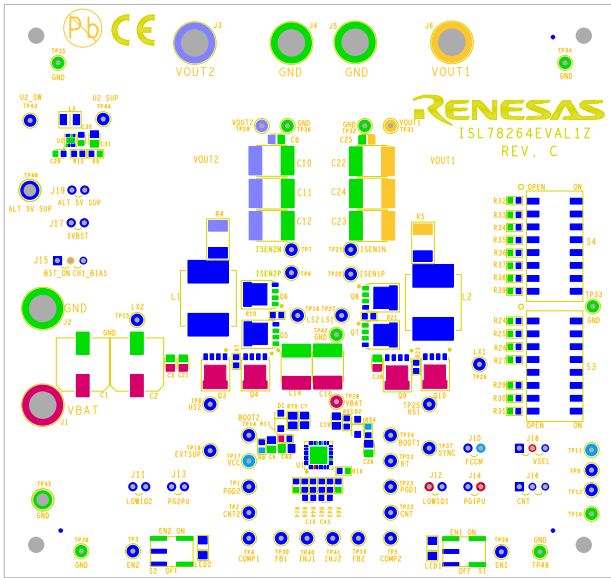

Figure 6. Silkscreen Top

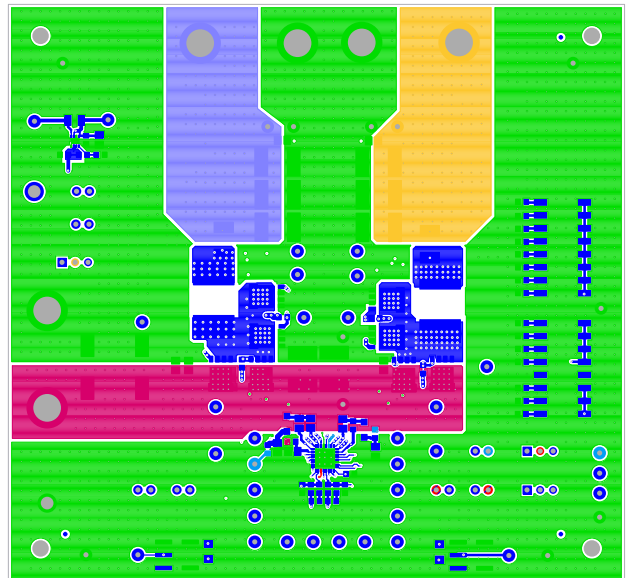

Figure 7. Layer 1

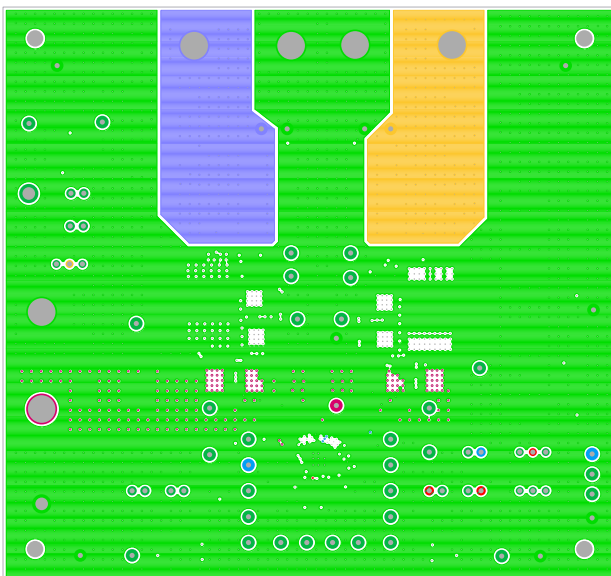

Figure 8. Layer 2

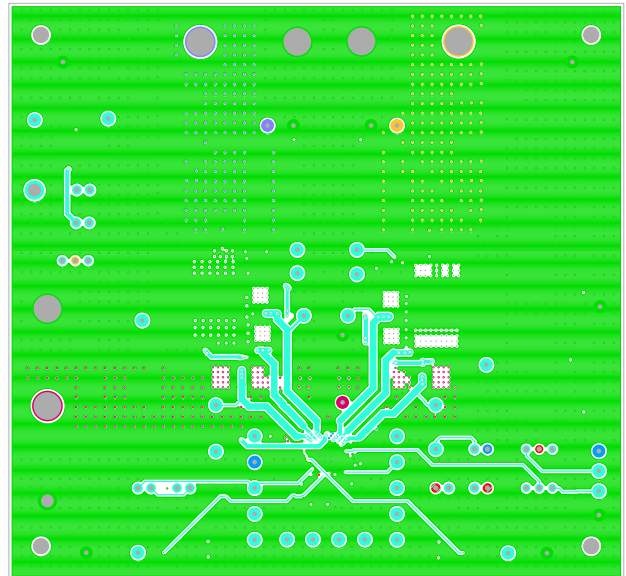

Figure 9. Layer 3

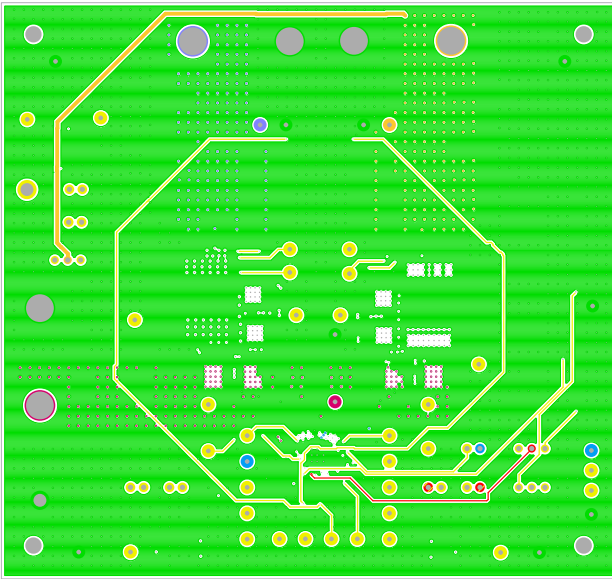

Figure 10. Layer 4

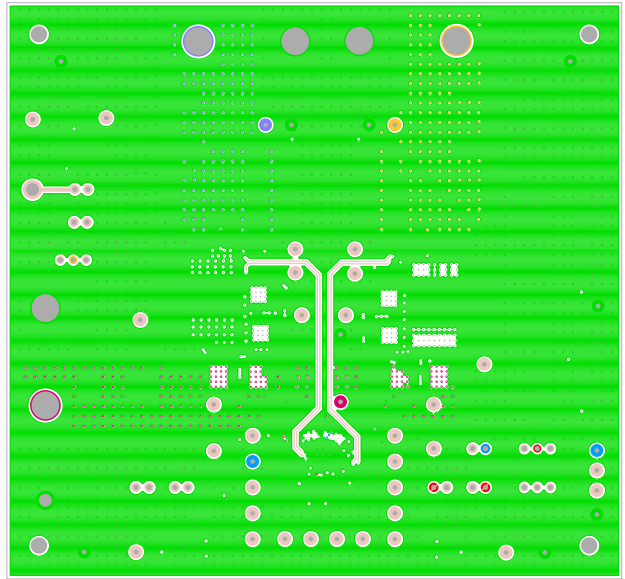

Figure 11. Layer 5

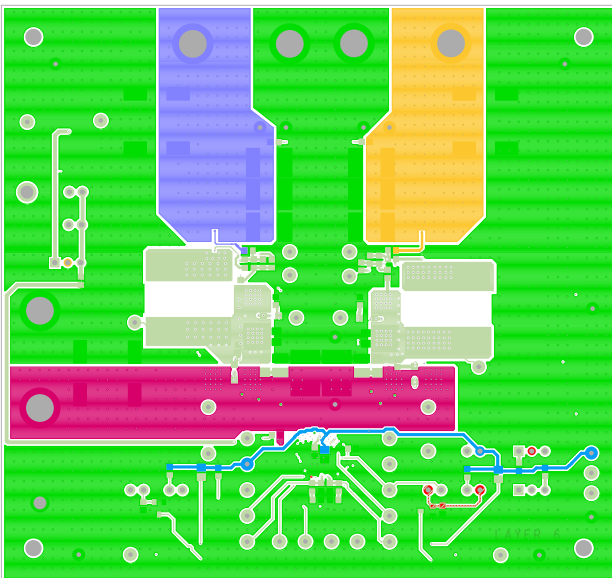

Figure 12. Layer 6

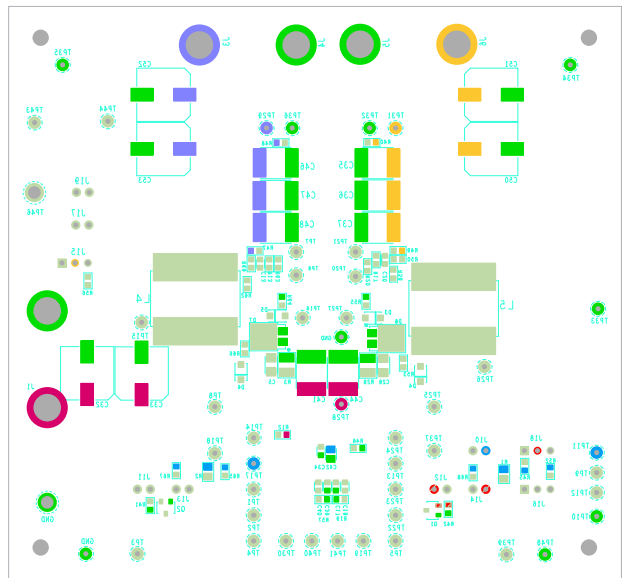

Figure 13. Silkscreen Bottom

3. Typical Performance Curves

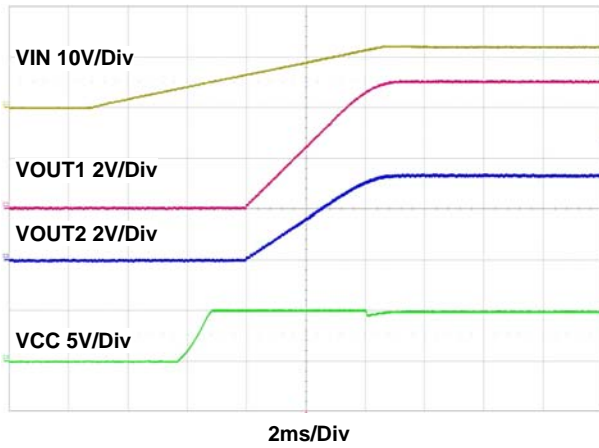

Figure 14. Buck 1/2 Start-Up with V_{IN} Rising

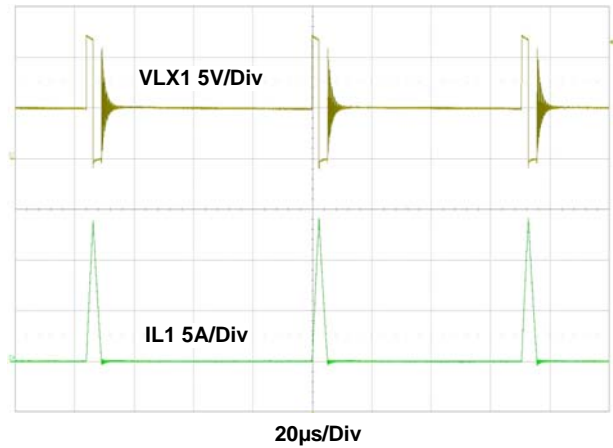

Figure 15. Steady State ECM Operation with $I_{OUT1} = 0.5A$

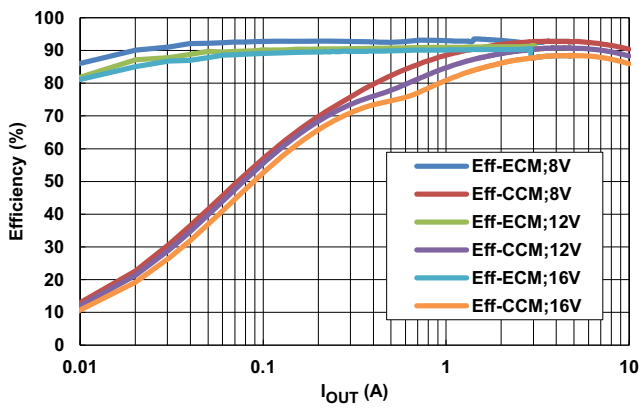

Figure 16. Buck 1 Efficiency $V_{OUT1} = 5V$

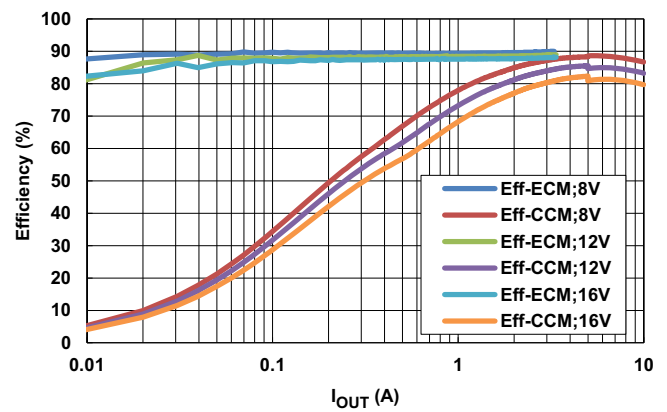

Figure 17. Buck 2 Efficiency $V_{OUT2} = 3.3V$

4. Revision History

Rev.	Date	Description
1.00	Jul.24.20	Initial release

ISL78264EVAL1Z

Notice

1. Descriptions of circuits, software and other related information in this document are provided only to illustrate the operation of semiconductor products and application examples. You are fully responsible for the incorporation or any other use of the circuits, software, and information in the design of your product or system. Renesas Electronics disclaims any and all liability for any losses and damages incurred by you or third parties arising from the use of these circuits, software, or information.
2. Renesas Electronics hereby expressly disclaims any warranties against and liability for infringement or any other claims involving patents, copyrights, or other intellectual property rights of third parties, by or arising from the use of Renesas Electronics products or technical information described in this document, including but not limited to, the product data, drawings, charts, programs, algorithms, and application examples.
3. No license, express, implied or otherwise, is granted hereby under any patents, copyrights or other intellectual property rights of Renesas Electronics or others.
4. You shall not alter, modify, copy, or reverse engineer any Renesas Electronics product, whether in whole or in part. Renesas Electronics disclaims any and all liability for any losses or damages incurred by you or third parties arising from such alteration, modification, copying or reverse engineering.
5. Renesas Electronics products are classified according to the following two quality grades: "Standard" and "High Quality". The intended applications for each Renesas Electronics product depends on the product's quality grade, as indicated below.

"Standard": Computers; office equipment; communications equipment; test and measurement equipment; audio and visual equipment; home electronic appliances; machine tools; personal electronic equipment; industrial robots; etc.

"High Quality": Transportation equipment (automobiles, trains, ships, etc.); traffic control (traffic lights); large-scale communication equipment; key financial terminal systems; safety control equipment; etc.

Unless expressly designated as a high reliability product or a product for harsh environments in a Renesas Electronics data sheet or other Renesas Electronics document, Renesas Electronics products are not intended or authorized for use in products or systems that may pose a direct threat to human life or bodily injury (artificial life support devices or systems; surgical implantations; etc.), or may cause serious property damage (space system; undersea repeaters; nuclear power control systems; aircraft control systems; key plant systems; military equipment; etc.). Renesas Electronics disclaims any and all liability for any damages or losses incurred by you or any third parties arising from the use of any Renesas Electronics product that is inconsistent with any Renesas Electronics data sheet, user's manual or other Renesas Electronics document.

6. When using Renesas Electronics products, refer to the latest product information (data sheets, user's manuals, application notes, "General Notes for Handling and Using Semiconductor Devices" in the reliability handbook, etc.), and ensure that usage conditions are within the ranges specified by Renesas Electronics with respect to maximum ratings, operating power supply voltage range, heat dissipation characteristics, installation, etc. Renesas Electronics disclaims any and all liability for any malfunctions, failure or accident arising out of the use of Renesas Electronics products outside of such specified ranges.
7. Although Renesas Electronics endeavors to improve the quality and reliability of Renesas Electronics products, semiconductor products have specific characteristics, such as the occurrence of failure at a certain rate and malfunctions under certain use conditions. Unless designated as a high reliability product or a product for harsh environments in a Renesas Electronics data sheet or other Renesas Electronics document, Renesas Electronics products are not subject to radiation resistance design. You are responsible for implementing safety measures to guard against the possibility of bodily injury, injury or damage caused by fire, and/or danger to the public in the event of a failure or malfunction of Renesas Electronics products, such as safety design for hardware and software, including but not limited to redundancy, fire control and malfunction prevention, appropriate treatment for aging degradation or any other appropriate measures. Because the evaluation of microcomputer software alone is very difficult and impractical, you are responsible for evaluating the safety of the final products or systems manufactured by you.
8. Please contact a Renesas Electronics sales office for details as to environmental matters such as the environmental compatibility of each Renesas Electronics product. You are responsible for carefully and sufficiently investigating applicable laws and regulations that regulate the inclusion or use of controlled substances, including without limitation, the EU RoHS Directive, and using Renesas Electronics products in compliance with all these applicable laws and regulations. Renesas Electronics disclaims any and all liability for damages or losses occurring as a result of your noncompliance with applicable laws and regulations.
9. Renesas Electronics products and technologies shall not be used for or incorporated into any products or systems whose manufacture, use, or sale is prohibited under any applicable domestic or foreign laws or regulations. You shall comply with any applicable export control laws and regulations promulgated and administered by the governments of any countries asserting jurisdiction over the parties or transactions.
10. It is the responsibility of the buyer or distributor of Renesas Electronics products, or any other party who distributes, disposes of, or otherwise sells or transfers the product to a third party, to notify such third party in advance of the contents and conditions set forth in this document.
11. This document shall not be reprinted, reproduced or duplicated in any form, in whole or in part, without prior written consent of Renesas Electronics.
12. Please contact a Renesas Electronics sales office if you have any questions regarding the information contained in this document or Renesas Electronics products.

(Note1) "Renesas Electronics" as used in this document means Renesas Electronics Corporation and also includes its directly or indirectly controlled subsidiaries.

(Note2) "Renesas Electronics product(s)" means any product developed or manufactured by or for Renesas Electronics.

(Rev.4.0-1 November 2017)

Corporate Headquarters

TOYOSU FORESIA, 3-2-24 Toyosu,
Koto-ku, Tokyo 135-0061, Japan
www.renesas.com

Contact Information

For further information on a product, technology, the most up-to-date version of a document, or your nearest sales office, please visit:
www.renesas.com/contact/

Trademarks

Renesas and the Renesas logo are trademarks of Renesas Electronics Corporation. All trademarks and registered trademarks are the property of their respective owners.