

# ISL6726EVAL2Z: 24V to 12V 90W Active Clamp Forward DC/DC Converter

## Introduction

The board is a 24V input to 12V output DC/DC converter that can output current up to 7.5A. It is implemented with Intersil's Active Clamp Forward (ACF) current-mode PWM controller, ISL6726. It demonstrates fundamental functions of ISL6726, including soft-start/soft-stop, peak current protection, average current protection, slope compensation, flux limit, minimum duty ratio clamp, etc. The circuit operates at fixed frequency with peak current mode control. The converter adopts ACF and synchronous rectifier to obtain high efficiency. Typical efficiency is about 92% at full load. This application note covers the test setup, test report, schematics, layout and BOM etc.

## Design Specifications

- Input Voltage  $V_{IN}$ : 18V to 36V
- Output Voltage  $V_O$ : 12V
- Output Current  $I_O$ : 7.5A (90W)
- Switching Frequency: 160kHz
- UVLO with Hysteresis, (18V/19V)
- Board Dimensions: 120×60×30mm<sup>3</sup> (L×W×H)

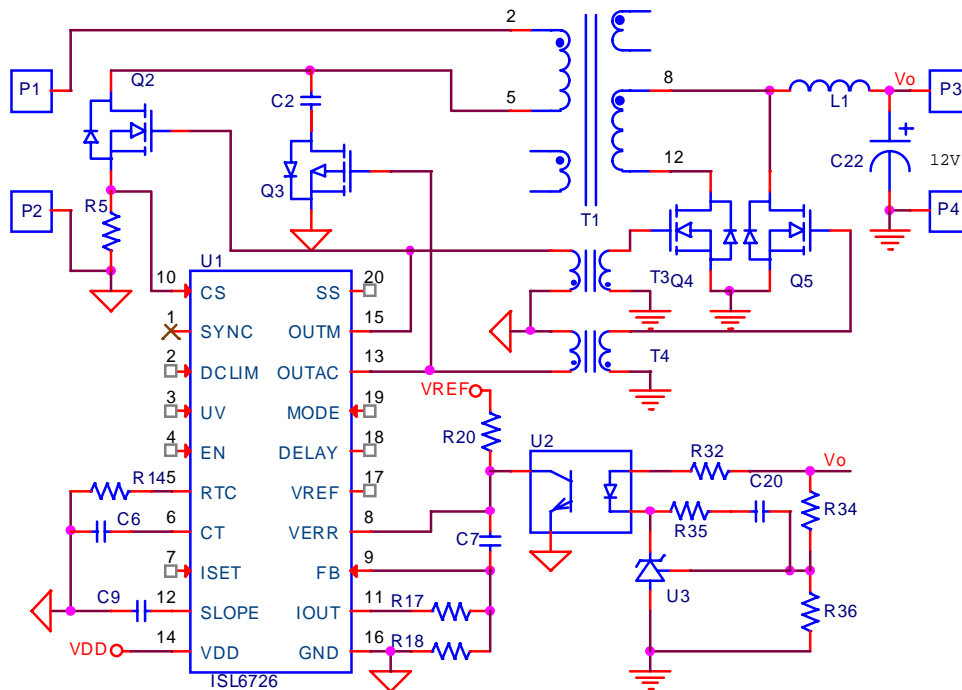

FIGURE 1. SIMPLIFIED SCHEMATIC

Figure 2 shows the test setup.

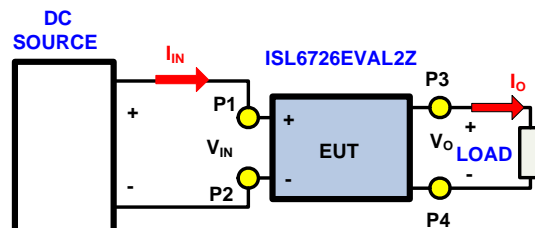

FIGURE 2. TEST SETUP

# Application Note 1717



FIGURE 3. TOP/BOTTOM VIEW OF THE EVALUATION BOARD

## Steady State Test

Figures 4 and 5 show the efficiency curves; line and load regulation are shown in Figures 6 and 7.

ISL6726 supports the brick-wall current limit protection feature shown in Figure 8.

TABLE 1. EFFICIENCY vs. LOAD CURRENT

$V_{IN}$ (V)	$I_{IN}$ (A)	$P_{IN}$ (W)	$V_O$ (V)	$I_O$ (mA)	$P_O$ (W)	LOAD (%)	$\eta$ (%)
24	0.243	5.8	12.05	0	0	0	-
23.99	0.530	12.7	12.048	0.755	9	10	71.5
23.98	0.894	21.4	12.047	1.5	18	20	84.2
23.97	1.289	30.8	12.047	2.246	27	30	87.5
23.95	1.689	40.4	12.046	3.006	36.2	40	89.5
23.94	2.080	49.7	12.045	3.752	45.1	50	90.7
23.93	2.480	59.3	12.044	4.499	54.1	60	91.3
23.92	2.884	68.9	12.043	5.245	63.1	70	91.5
23.9	3.297	78.7	12.042	6.005	72.3	80	91.7
23.99	3.690	88.5	12.04	6.744	81.1	90	91.7
23.98	4.093	98.1	12.038	7.472	89.9	99	91.6

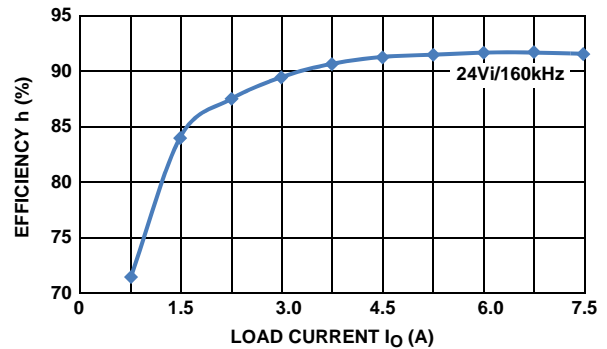

FIGURE 4. EFFICIENCY vs. LOAD CURRENT

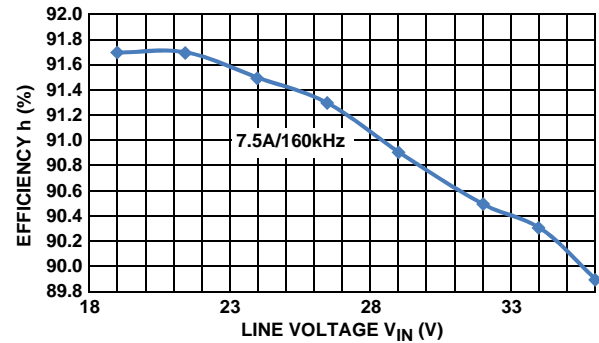

FIGURE 5. EFFICIENCY vs. LINE VOLTAGE

TABLE 2. EFFICIENCY vs. INPUT VOLTAGE

$V_{IN}$ (V)	$I_{IN}$ (A)	$P_{IN}$ (W)	$V_O$ (V)	$I_O$ (mA)	$P_O$ (W)	LOAD (%)	$\eta$ (%)
19.06	5.136	97.8	12.033	7.468	89.8	99	91.7
21.47	4.562	97.9	12.033	7.468	89.8	99	91.7
23.98	4.093	98.1	12.033	7.468	89.8	99	91.5
26.47	3.717	98.3	12.033	7.468	89.8	99	91.3
29.07	3.397	98.7	12.032	7.468	89.8	99	90.9
31.97	3.102	99.1	12.031	7.468	89.8	99	90.5
34.07	2.92	99.4	12.031	7.468	89.8	99	90.3
36	2.773	99.8	12.03	7.468	89.8	99	89.9

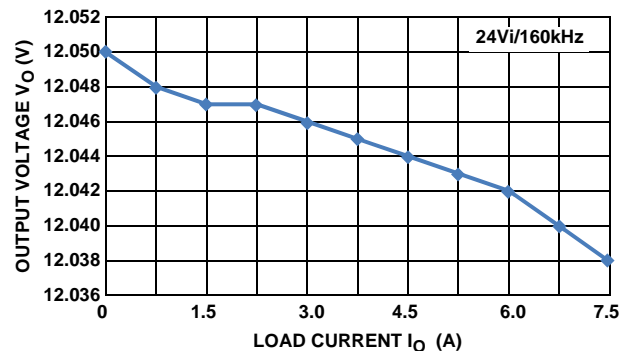

FIGURE 6. LOAD REGULATION

# Application Note 1717

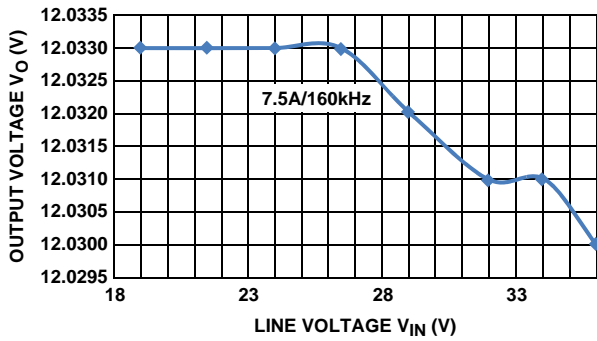

FIGURE 7. LINE REGULATION

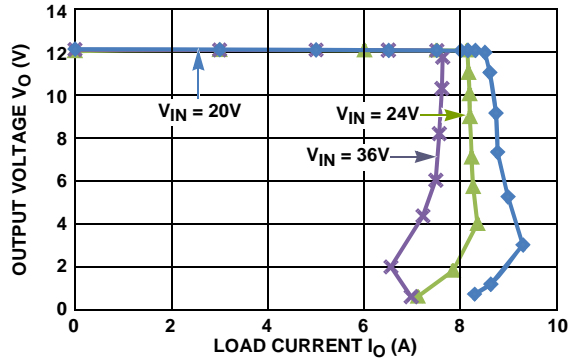

FIGURE 8. BRICK-WALL CURRENT LIMIT

Typical waveforms are shown in Figures 9~11.

Test conditions:  $V_{IN} = 24V$ .

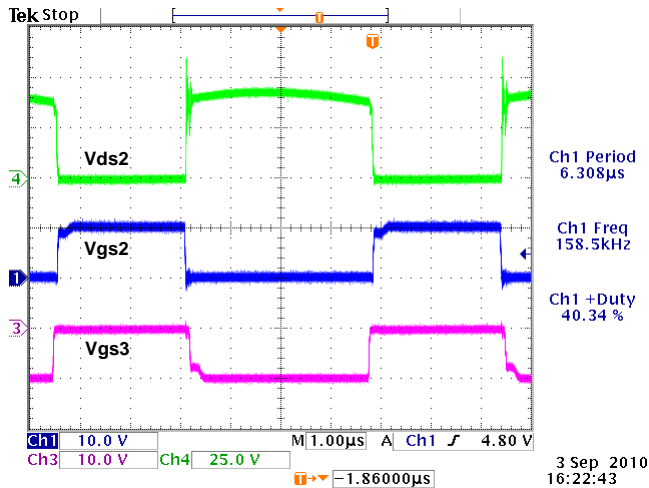

FIGURE 9. Q2 AND Q3 SWITCHING WAVEFORMS ( $I_O = 1.6A$ )

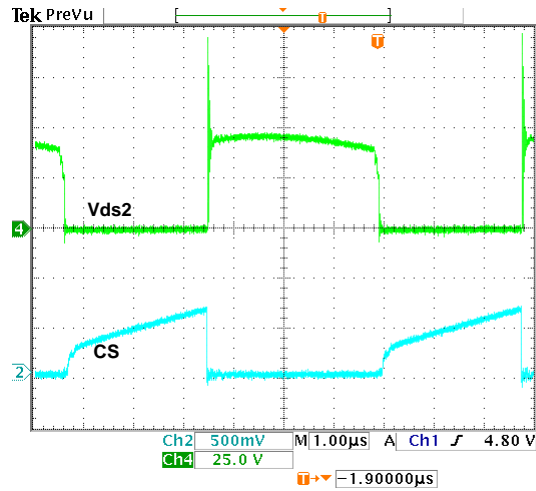

FIGURE 10. SIGNAL WAVEFORM ON CS PIN

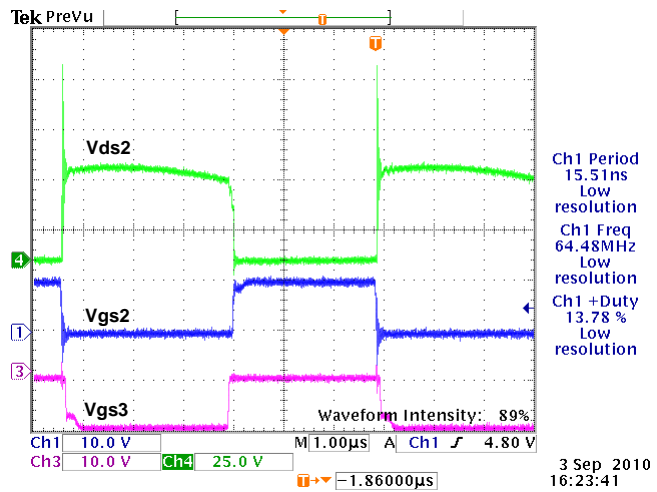

FIGURE 11. Q2 AND Q3 SWITCHING WAVEFORMS ( $I_O = 7.5A$ )

For Figures 9~11:

- Ch1: Vgs of Q2;
- Ch3: Vgs of Q3;
- Ch2: CS signal of ISL6726;
- Ch4: Vds of Q2.

# Application Note 1717

Figure 12 and 13 are waveforms of Q4 (Rectifier/Forward switch)

Figures 14 and 15 are Waveforms of Q5 (Freewheeling Switch).

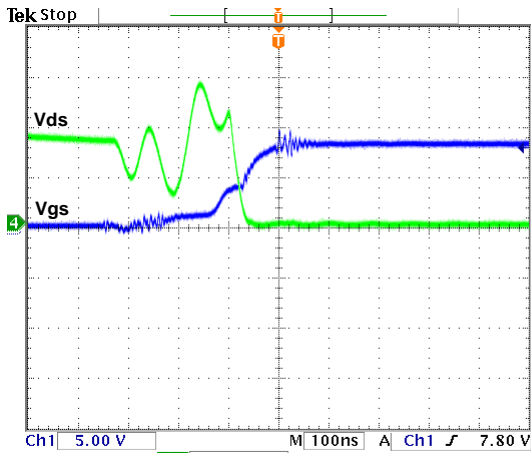

FIGURE 12. Q4 TURN ON, NO LOAD

1 Sep 2010  
14:17:22

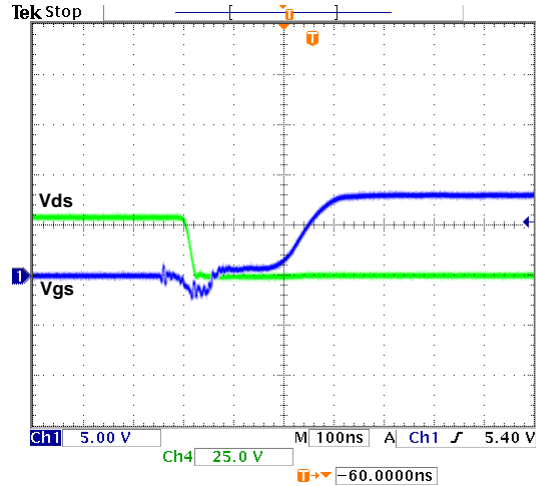

FIGURE 14. Q5 TURN ON, NO LOAD

30 Aug 2010  
18:04:26

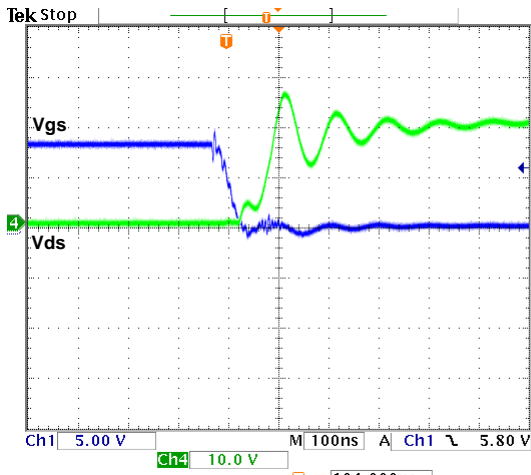

FIGURE 13. Q4 TURN OFF, NO LOAD

1 Sep 2010  
14:18:57

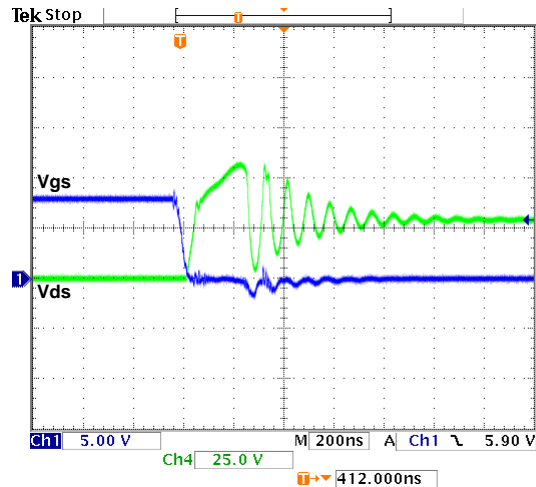

FIGURE 15. Q5 TURN OFF, NO LOAD

30 Aug 2010  
18:05:09

# Application Note 1717

Table 3 shows the output ripple voltage.

TABLE 3.  $V_{OUT}$  RIPPLE; CH3: 50mV/DIV; TIME: 4 $\mu$ s/DIV

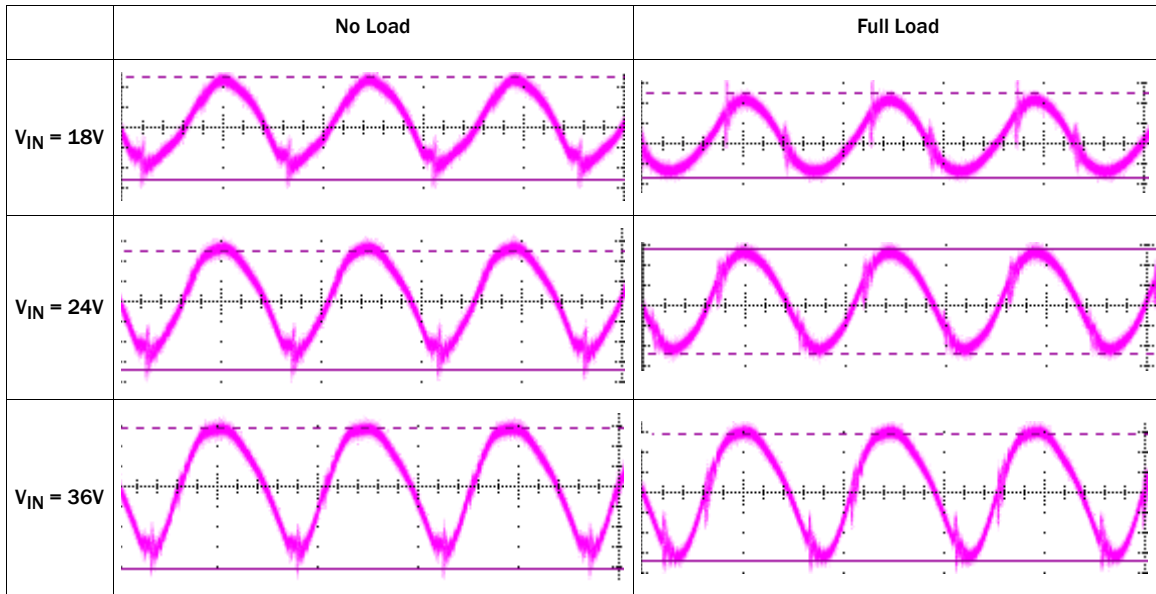

## Dynamic Response Test

Table 4 shows the dynamic response at different input conditions. The load current slew rate is 0.2A/ $\mu$ s for the step transient.

TABLE 4.  $V_{OUT}$  DYNAMIC RESPONSE; CH3: 500mV/DIV; TIME: 4ms/DIV

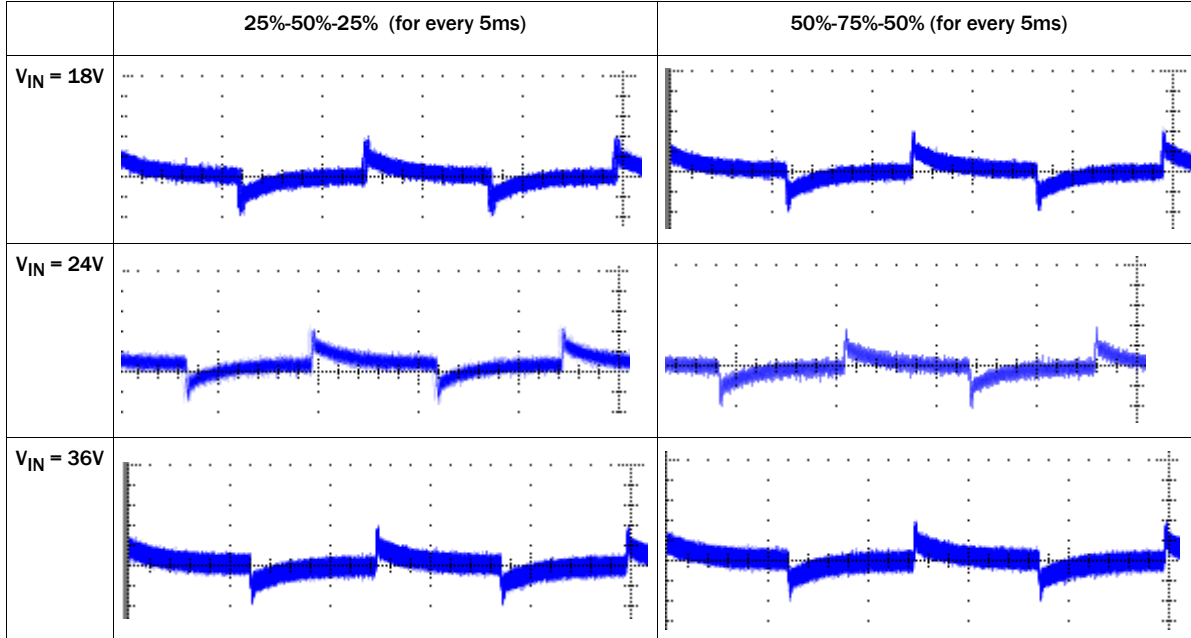

# Application Note 1717

Figure 16 and 17 show the soft-start and soft-stop waveforms. The active load is set to constant-current (CC) mode.

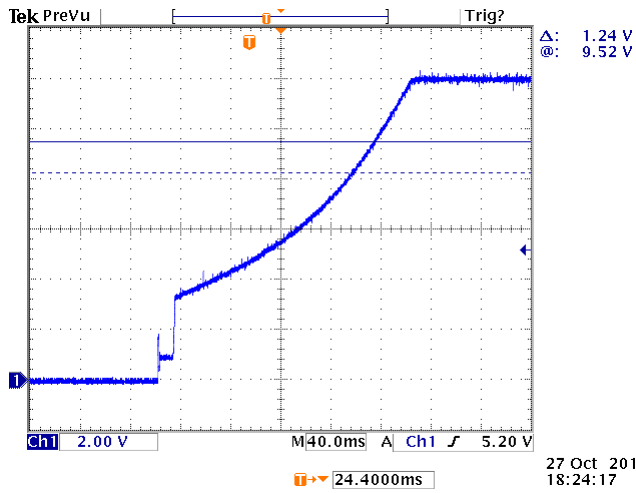

FIGURE 16.  $V_{OUT}$  DURING START-UP

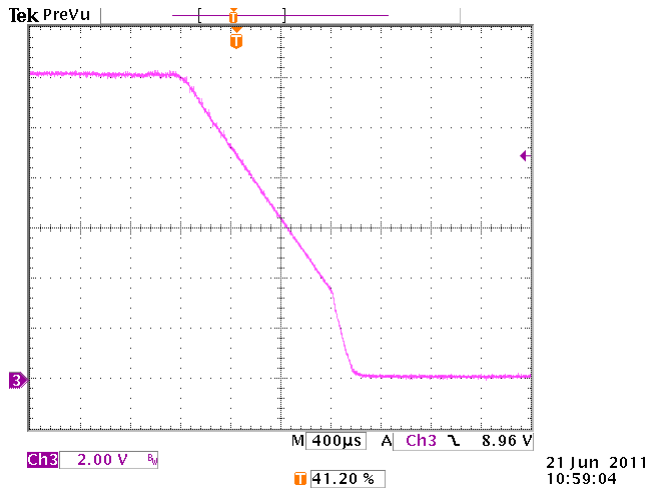
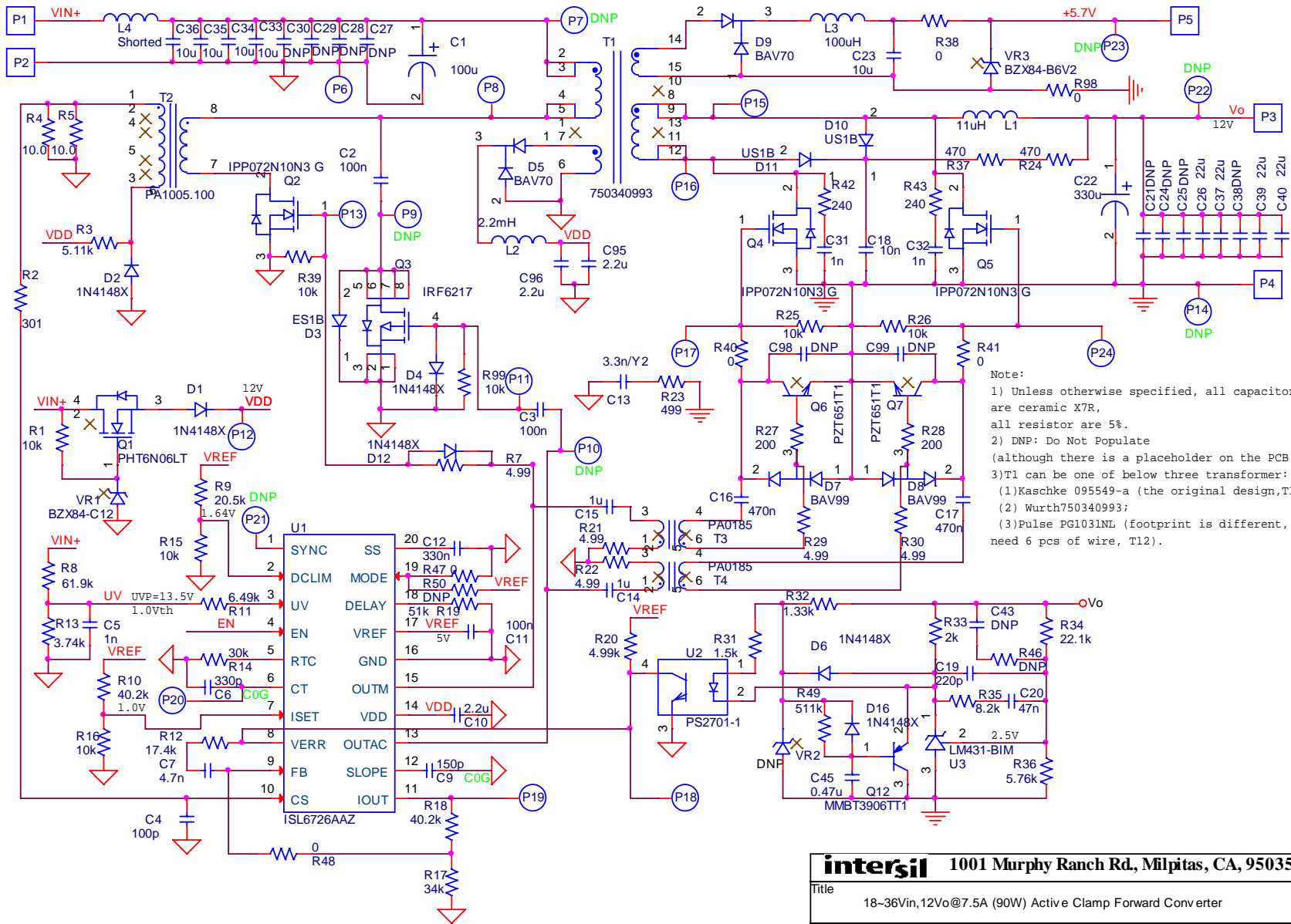

FIGURE 17.  $V_{OUT}$  DURING SHUT-DOWN

# Schematic



Note:  
 1) Unless otherwise specified, all capacitors are ceramic X7R, all resistor are 5%.  
 2) DNP: Do Not Populate (although there is a placeholder on the PCB)  
 3) T1 can be one of below three transformer:  
 (1)Kaschke 095549-a (the original design,T11);  
 (2) Wurth750340993;  
 (3)Pulse PG1031NL (footprint is different, need 6 pcs of wire, T12).

<b>intersil</b> 1001 Murphy Ranch Rd, Milpitas, CA, 95035		
Title 18-36Vin,12Vo@7.5A (90W) Active Clamp Forward Converter		
Size A	Document Number ISL6726EVAL2Z	Rev B
Date: Thursday, October 27, 2011	Sheet 1	of 1

FIGURE 18. SCHEMATIC ISL6726EVAL2Z

# Application Note 1717

## Bill of Materials

TABLE 5. BOM FOR ISL6726EVAL2Z REV. B

QTY	REFERENCE DESIGNATOR	TYPE/MOUNT/PACKAGE/VOL/TOL/MAT	MANUFACTURER	MANUFACTURER PART #
1	C1	Cap, TH, DiaxL = 10x12.5mm, 100μ, 50V, 20%, ELECT, Aluminum	Nichicon	UBT1H101MPD
1	C2	Cap, SM, 1206, 100n, 250V, 20%, X7R		
2	C3, C11	Cap, SM, 0603, 100n, 25V, 20%, X7R		
1	C4	Cap, SM, 0603, 100p, 25V, 20%, X7R		
1	C5	Cap, SM, 0603, 1n, 25V, 20%, X7R		
1	C6	Cap, SM, 0603, 330p, 25V, 20%, COG		
1	C7	Cap, SM, 0603, 4.7n, 25V, 20%, X7R		
0	C8, C43	Cap, SM, 0603, DNP, 25V, 20%, X7R		
1	C9	Cap, SM, 0603, 150p, 25V, 20%, COG		
3	C10, C95, C96	Cap, SM, 0805, 2.2μ, 16V, 20%, X7R		
1	C12	Cap, SM, 0603, 330n, 10V, 20%, X7R		
1	C13	Cap, SM, 2220, 3.3n/Y2, 20%, Monolithic Ceramic	Murata	GA355QR7GF332KW01L
2	C14, C15	Cap, SM, 0603, 1μ, 16V, 20%, X7R		
2	C16, C17	Cap, SM, 0603, 470n, 16V, 20%, X7R		
1	C18	Cap, SM, 1210, 10n, 100V, 20%, X7R		
1	C19	Cap, SM, 0603, 220p, 25V, 20%, X7R		
1	C20	Cap, SM, 0603, 47n, 25V, 20%, X7R		
0	C21, C24, C25, C38	Cap, SM, 1210, DNP, 16V, 20%, X7R	Murata	GRM43ER61C226KE01L
1	C22	Cap, TH, DiaxL = 10x12.5 mm, 330μ, 16V, 20%, ELECT, Aluminum	Nichicon	UBT1C331MPD
1	C23	Cap, SM, 1206, 10μ, 16V, 20%, X7R		
4	C26, C37, C39, C40	Cap, SM, 1210, 22μ, 16V, 20%, X7R	Murata	GRM43ER61C226KE01L
0	C27, C28, C29, C30	Cap, SM, 1210, DNP, 50V, 20%, X7R		
2	C31, C32	Cap, SM, 1206, 1n, 100V, 20%, X7R	Murata	GRM21AR72E102KW01D
4	C33, C34, C35, C36	Cap, SM, 1210, 10μ, 50V, 20%, X7R		
1	C45	Cap, SM, 0805, 0.47μ, 16V, 20%, X7R		
0	C98, C99	Cap, SM, 0603, DNP, 16V, 20%, X7R		
6	D1, D2, D4, D6, D12, D16	Diode, SM, SOD523, 1N4148, 75V, 250mA, SWITCH	MCC	1N4148X
1	D3	Diode, SM, SMA, ES1B, Fast Recovery	Fairchild	
2	D5, D9	Diode, SM, SOT-23, BAV70, Fast Recovery	Diodes Inc	
2	D7, D8	Diode, SM, SOT-23, BAV99, Fast Recovery	Diodes Inc	
2	D10, D11	Diode, SM, SMA, US1B, Ultra Fast Recovery	Diodes Inc	
1	L1	11μH	Pulse	PG0936.113NL
		2 <sup>nd</sup> source of L1	Wurth	74435561100
1	L2	Inductor, SM, 2.2mH	CoilCraft	LPS4018-225MLD
1	L3	Inductor, SM, 100μH	Sunlord	SDWL3225F101JTF
0	L4	Bare wire		
5	P1, P2, P3, P4, P5	Terminal, TH, 1514-2	KeyStone	1562-4



# Application Note 1717

TABLE 5. BOM FOR ISL6726EVAL2Z REV. B

QTY	REFERENCE DESIGNATOR	TYPE/MOUNT/PACKAGE/VOL/TOL/MAT	MANUFACTURER	MANUFACTURER PART #
12	P6, P8, P11~13, P15~20, P24	5002	KEystone	5002
0	P7, P9, P10, P14, P21, P22, P23	DNP	KEystone	5002
1	Q1	MOSFET, SM, SOT-223, PHT6N06LT, N-Chan	NXP	
2	Q2, Q5	MOSFET, TH, TO-220F, IPP072N10N3 G	Infineon	
1	Q3	MOSFET, SM, SO-8, IRF6217, P-Chan	IR	
1	Q4	MOSFET, SM, TO-220F, IPP072N10N3 G	Infineon	
2	Q6, Q7	BJT, SM, SOT-223, PZT651T1, NPN	ON Semi	
0	Q8	SOT-26, DNP, Dual PNP	Diodes Inc	
0	Q11	MOSFET, SM, SOT-23, DNP, N-Chan	ON Semi	
1	Q12	BJT, SM, SOT-23, MMBT3906TT1, PNP	ON Semi	
1	R1	Res, SM, 1206, 10k, 1%, Thick Film		
1	R2	Res, SM, 0603, 301, 1%, Thick Film		
1	R3	Res, SM, 0603, 5.11k, 1%, Thick Film		
2	R4, R5	Res, SM, 0603, 10.0, 1%, Thick Film		
5	R7, R21, R22, R29, R30	Res, SM, 0603, 4.99, 1%, Thick Film		
1	R8	Res, SM, 0603, 61.9k, 1%, Thick Film		
1	R9	Res, SM, 0603, 20.5k, 1%, Thick Film		
2	R10, R18	Res, SM, 0603, 40.2k, 1%, Thick Film		
1	R11	Res, SM, 0603, 6.49k, 1%, Thick Film		
1	R12	Res, SM, 0603, 17.4k, 1%, Thick Film		
1	R13	Res, SM, 0603, 3.74k, 1%, Thick Film		
1	R14	Res, SM, 0603, 30k, 1%, Thick Film		
6	R15, R16, R25, R26, R39, R99	Res, SM, 0603, 10k, 1%, Thick Film		
1	R17	Res, SM, 0603, 34k, 1%, Thick Film		
1	R19	Res, SM, 0603, 51k, 1%, Thick Film		
1	R20	Res, SM, 0603, 4.99k, 1%, Thick Film		
1	R23	Res, SM, 0603, 499, 1%, Thick Film		
2	R24, R37	Res, SM, 2512, 470, 1%, Thick Film		
2	R27, R28	Res, SM, 0603, 200, 1%, Thick Film		
1	R31	Res, SM, 0603, 1.5k, 1%, Thick Film		
1	R32	Res, SM, 0603, 1.33k, 1%, Thick Film		
1	R33	Res, SM, 0603, 2k, 1%, Thick Film		
1	R34	Res, SM, 0603, 22.1k, 1%, Thick Film		
1	R35	Res, SM, 0603, 8.2k, 1%, Thick Film		
1	R36	Res, SM, 0603, 5.76k, 1%, Thick Film		
6	R38, R40, R41, R47, R48, R98	Res, SM, 0603, 0, 1%, Thick Film		
2	R42, R43	Res, SM, 2512, 240, 5%, Thick Film		

## Application Note 1717

**TABLE 5. BOM FOR ISL6726EVAL2Z REV. B**

QTY	REFERENCE DESIGNATOR	TYPE/MOUNT/PACKAGE/VOL/TOL/MAT	MANUFACTURER	MANUFACTURER PART #
0	R45, R52, R53	Res, SM, 0603, DNP, 1%, Thick Film		
0	R46, R50	Res, SM, 0603, DNP, 1%, Thick Film		
1	R49	Res, SM, 0603, 511k, 1%, Thick Film		
1	T1	Txfmr, SM, 750340993, Transformer	Würth Midcom	750340993
		2nd source of T1	Pulse	PG1031NL
		2nd source of T1	Kaschke Components	095549-a
1	T2	Txfmr, SM, PA1005.100, Current Transformer	Pulse	PA1005.100NL
		2 <sup>nd</sup> source of T2	Würth Midcom	31333R-LF1
2	T3, T4	Txfmr, SM, PA0185, Gate driver	Pulse	PA0185
1	U1	IC, SM, SSOP20, ISL6726, PWM controller	Intersil	ISL6726AAZ
1	U2	IC, SM, SSOP4, PS2701-1, Photo Coupler	NEC	
1	U3	IC, SM, SOT-23, LM431-BIM, Shunt Regulator	National	
1	VR1	Diode, SM, SOT-23, BZX84-C12, Zener	NXP	
1	VR2	DNP		

Assembly Drawing

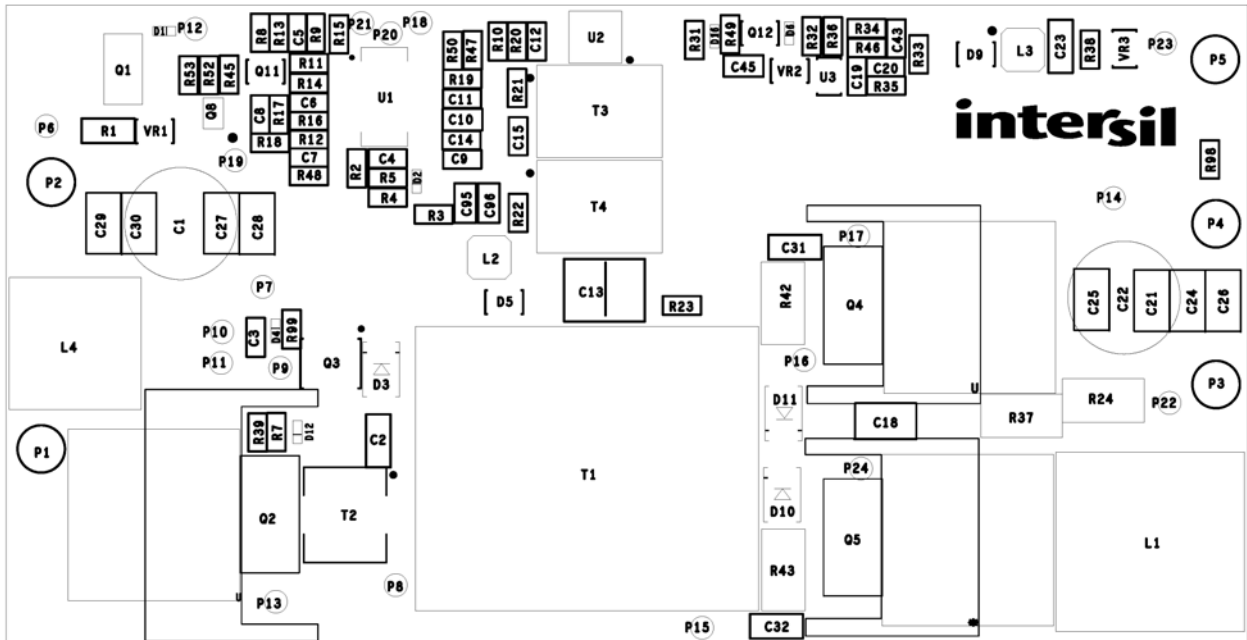

FIGURE 19. ASSEMBLY ON TOP

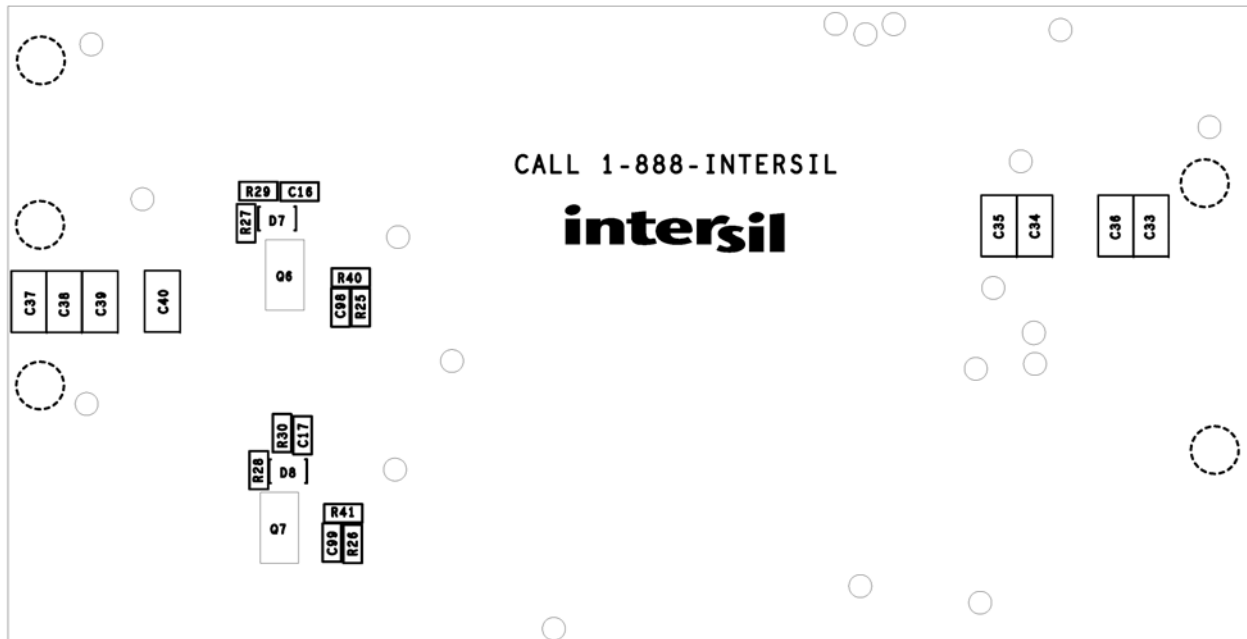

FIGURE 20. ASSEMBLY ON BOTTOM

## PCB Layout

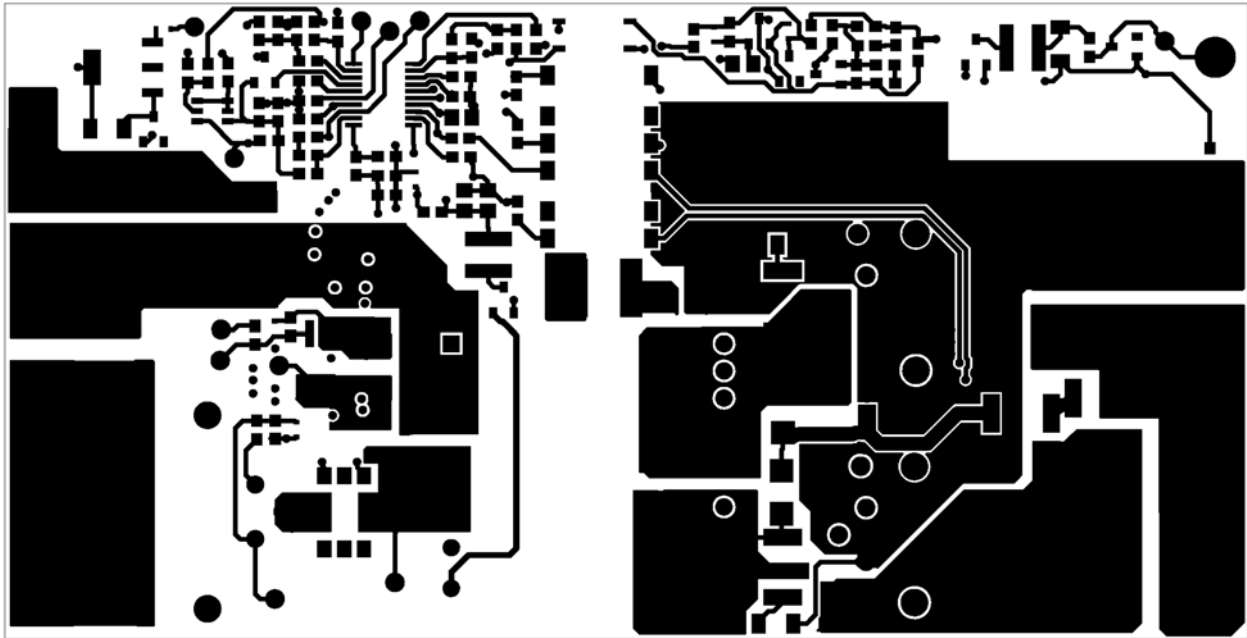

FIGURE 21. LAYER 1 (TOP LAYER)

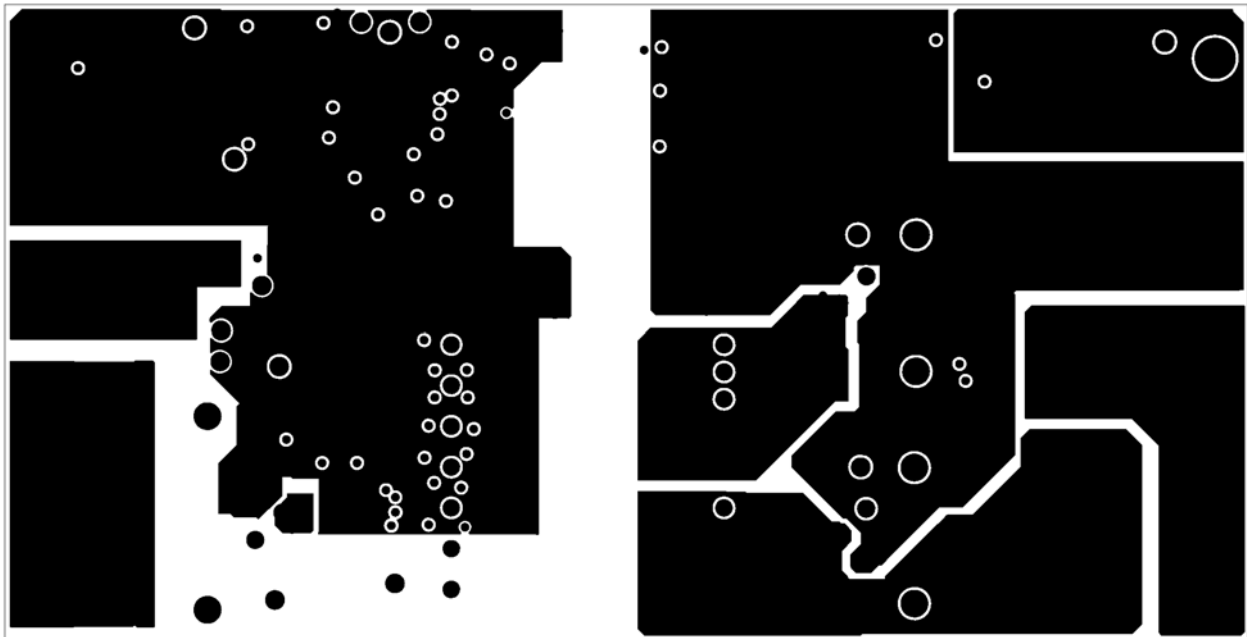

FIGURE 22. LAYER 2

PCB Layout (Continued)

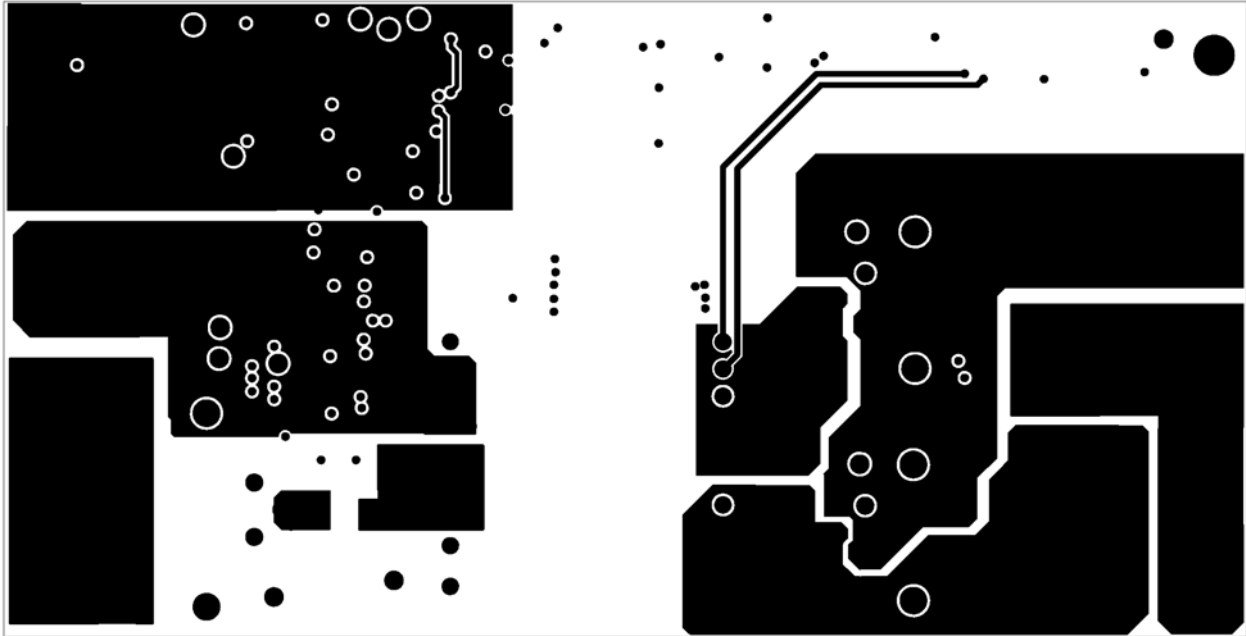

FIGURE 23. LAYER 3

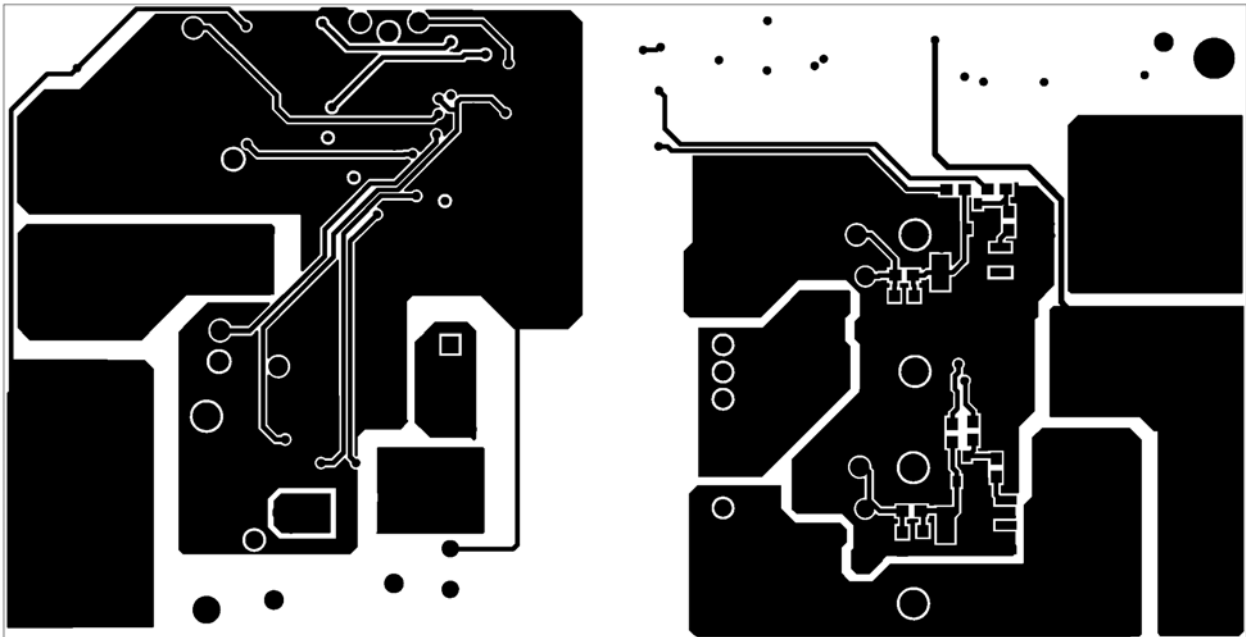

FIGURE 24. LAYER 4 (BOTTOM LAYER)

Intersil Corporation reserves the right to make changes in circuit design, software and/or specifications at any time without notice. Accordingly, the reader is cautioned to verify that the Application Note or Technical Brief is current before proceeding.

For information regarding Intersil Corporation and its products, see [www.intersil.com](http://www.intersil.com)