

# Go Configure™ Software Hub

## User Guide

v.2.5.1

# Contents

<b>1</b>	<b>Introduction</b>	<b>4</b>
1.1	Quick start . . . . .	5
1.1.1	System requirements . . . . .	5
1.1.2	Getting started . . . . .	5
1.1.3	Support . . . . .	5
<b>2</b>	<b>Software overview</b>	<b>6</b>
2.1	Design tools . . . . .	7
2.1.1	Interface overview . . . . .	8
2.1.2	Working with project files . . . . .	13
2.1.3	NVM viewer . . . . .	20
2.1.4	Components . . . . .	21
2.1.5	Connections . . . . .	24
2.1.6	Keyboard commands . . . . .	27
2.1.7	Settings . . . . .	28
2.1.8	Legend box . . . . .	32
2.1.9	Help window . . . . .	32
2.1.10	Snipping tool . . . . .	34
2.1.11	Rule checker . . . . .	35
2.1.12	Comparison tool . . . . .	36
2.1.13	Power Dissipation Calculator . . . . .	39
2.1.14	Acceleration Profile Configurator . . . . .	43
2.1.15	Reg File Configurator . . . . .	45
2.2	Debug tools . . . . .	47
2.2.1	Hardware sources . . . . .	48
2.2.2	Generators . . . . .	52
2.2.3	Signal Wizard . . . . .	66
2.2.4	Custom Signal Wizard . . . . .	68
2.2.5	Hardware configurations . . . . .	69
2.2.6	Debugging Controls . . . . .	70
2.2.7	Project data window . . . . .	77
2.2.8	Demo Board and Demo mode . . . . .	79
2.2.9	I2C Tools . . . . .	80

2.2.10	I2C I/O Tool . . . . .	88
2.2.11	Logic Analyzer . . . . .	91
2.2.12	UART Terminal . . . . .	99
2.2.13	DAC Tool . . . . .	100
2.2.14	OTP Programmer . . . . .	102
2.2.15	Voltage Monitor . . . . .	104
2.2.16	Power Monitor . . . . .	105
2.3	Configuration tools . . . . .	107
2.3.1	Asynchronous State Machine Editor . . . . .	107
2.3.2	EPG Waveform Editor . . . . .	111
2.3.3	Timing Diagram . . . . .	115
2.3.4	Memory Table Editor . . . . .	117
2.4	Software simulation tool . . . . .	121
2.4.1	Schematic Library . . . . .	121
2.4.2	External components . . . . .	123
2.4.3	Working with models and subcircuits . . . . .	124
2.4.4	Source Setup . . . . .	127
2.4.5	Simulation configurations . . . . .	130
2.4.6	Probes . . . . .	131
2.4.7	Debugging Controls . . . . .	133
2.4.8	Simulation progress . . . . .	134
2.4.9	Simulation Results window . . . . .	137
2.5	FPGA Editor tool . . . . .	141
2.5.1	Flowchart . . . . .	141
2.5.2	Interface overview . . . . .	142
2.5.3	Design Templates . . . . .	146
2.5.4	Writing Verilog code . . . . .	149
2.5.5	Modules Library . . . . .	150
2.5.6	Synthesis . . . . .	152
2.5.7	Generating Bitstream . . . . .	155
2.5.8	Project directory structure . . . . .	158
2.5.9	Simulation . . . . .	159
2.5.10	Macrocell Editor . . . . .	161
2.5.11	PLL Calculator . . . . .	163
2.5.12	Settings . . . . .	164
<b>3</b>	<b>Devices</b> . . . . .	<b>166</b>
3.1	GreenPAK devices . . . . .	167
3.1.1	GreenPAK Advanced Development Platform . . . . .	167
3.1.2	GreenPAK DIP Development Platform . . . . .	169
3.1.3	GreenPAK Lite Development Platform . . . . .	171
3.1.4	GreenPAK Serial Debugger . . . . .	174
3.1.5	Connecting external GreenPAK . . . . .	176
3.2	ForgeFPGA devices . . . . .	178
3.2.1	ForgeFPGA™ Advanced Development Boards . . . . .	178
3.2.2	ForgeFPGA™ Evaluation Board . . . . .	183
3.3	PowerPAK Devices . . . . .	185
3.3.1	PowerPAK Development Platform . . . . .	185
3.3.2	PowerPAK SLG51002C Demo board . . . . .	187

3.3.3	Connecting external PowerPAK . . . . .	189
<b>4</b>	<b>How to</b>	<b>192</b>
4.1	Software update . . . . .	193
4.2	Printing . . . . .	194
4.2.1	Print . . . . .	194
4.2.2	Print Editor (obsolete) . . . . .	195
4.3	Icarus Verilog and GTKWave quick start . . . . .	197
4.3.1	Installation . . . . .	197
4.3.2	Quick start . . . . .	197
<b>5</b>	<b>Troubleshooting</b>	<b>200</b>
5.1	Failed Socket Test . . . . .	201
<b>6</b>	<b>Appendices</b>	<b>202</b>
6.1	Main menu commands . . . . .	203
6.2	Keyboard and mouse controls . . . . .	205
6.3	Debugging Controls feature availability . . . . .	208
6.4	Abbreviations . . . . .	209
6.5	Changelog . . . . .	210



# 1 Introduction

*Renesas Go Configure™ Software Hub* is a full-featured Integrated Development Environment (IDE) that enables a completely graphical design process, allowing you to configure, program and simulate custom circuits in minutes.

This guide provides the information for the usage of *Go Configure Software Hub*, describing the features for *Renesas* products, such as *GreenPAK™*, *AnalogPAK*, *HVPAK™*, *Power GreenPAK*, *AutomotivePAK*, and *ForgeFPGA™ Workshop*.

# 1.1 Quick start

## 1.1.1 System requirements

Minimum system requirements for *Go Configure Software Hub*:

- ▶ CPU: Dual core 2.5 GHz
- ▶ RAM: 8 GB
- ▶ GPU: 128 MB
- ▶ Free disk space: 2 GB
- ▶ OS: Windows 10/11, macOS 11 or higher, Ubuntu 22.04/24.04, Debian 12/Testing

## 1.1.2 Getting started

1. [Download](#) and install *Go Configure Software Hub*
2. Open the particular chip Part Number
3. Select the components for your project
4. Specify the pinout
5. Configure and interconnect the components
6. Test the design with the *Debug Tool*, using *Simulation* feature or any of the supported hardware development platforms

## 1.1.3 Support

In case you need more information about *Go Configure Software Hub*, online support is available at [www.renesas.com](http://www.renesas.com).

You can also find *Go Configure Software Hub* on *Renesas* social media. To visit the page, go to *Help* → *Social* in the main menu.

The latest version of the software application is available on the [Renesas website](#), on [Software](#) page.

*Go Configure Software Hub* notifies about pending software updates. You can learn more in section [4.1 Software update](#).

# 2 Software overview

The *Go Configure Software Hub* was designed to provide direct access to all *GreenPAK*, *SLG51000/1*, and *ForgeFPGA* device features and complete control over the routing and configuration options.

In this chapter, you'll find detailed explanations for various tools to simplify your workflow. These tools allow you to program a chip with your custom design, import data from a programmed part, and simulate with external components. This chapter will also become your guide to exploring the software interface and understanding essential tools like debug tools, asynchronous state machine, software simulation, and FPGA editor, etc.

## 2.1 Design tools

Start your project from the *Hub* window with the following sections:

- *Welcome* — useful info and tips for new users
- *Recent files* — the list of the recently opened [project files](#)
- *Develop* — the chip Part Number selection. See the *Details* section to learn more about the selected chip

At the bottom of the window, you can find the *New*, *Open*, and *Close* buttons, which allow you to start a new project for a selected Part Number, open an existing project or close the *Go Configure Software Hub*. The *Datasheets* and *User Guides* buttons redirect you to the *Renesas* website, where you can download the corresponding files.

- *Demo* — the list of *Demo* projects. You can use the specific *Demo Board* for the project debugging (read more in section [2.2.8 Demo Board and Demo mode](#))
- *Application notes* — design examples for different purposes. An application note includes a design description with various Integrated Circuits (ICs) and a preconfigured circuit project, where you can make customized changes
- *Recovery files* — restored project files after a crash or freeze. To read more refer to section [2.1.7 Settings](#)

The screenshot shows the Go Configure Software Hub interface. On the left is a navigation sidebar with buttons for Welcome, Recent files, Develop, Demo, Application notes, Recovery files, Datasheets, and User guide. The main area displays a table of parts for the selected part family 'SLG47512V'. The table has columns for Part Number, DS, VDD (V), VDD2 (V), GPI|GPO|GPIO, and AEC-Q100. The selected part is SLG47512V, which is highlighted in grey. Below the table is a 'Details' section for the selected part, including package information (STQFN-12), supported development platforms, and a description of the device's features and macrocells.

Part Number	DS	VDD (V)	VDD2 (V)	GPI GPO GPIO	AEC-Q100
SLG47115V	<a href="#">PDF</a>	2.30 to 5.50	4.50 to 26.40	1 2 7	-
SLG47105V	<a href="#">PDF</a>	2.30 to 5.50	3.00 to 13.20	1 4 7	-
SLG46811V	<a href="#">PDF</a>	2.30 to 5.50	-	1 0 9	-
SLG47513M	<a href="#">PDF</a>	1.00 to 1.65	-	1 0 13	-
SLG47512V	<a href="#">PDF</a>	1.00 to 1.65	-	1 0 9	-
SLG46867M	<a href="#">PDF</a>	2.30 to 5.50	-	1 1 10	-
SLG46857-AP	<a href="#">Contact us</a>	2.30 to 5.50	-	1 1 10	Grade 1
SLG46855-AP	<a href="#">PDF</a>	2.30 to 5.50	-	1 1 10	Grade 2
SLG46855V	<a href="#">PDF</a>	2.30 to 5.50	-	1 1 10	-
SLG46827-AG	<a href="#">PDF</a>	2.30 to 5.50	1.71 to 5.50	2 2 13	Grade 2
SI G46826G	<a href="#">PDF</a>	2.30 to 5.50	1.71 to 5.50	2 2 13	-

**Details**

[ [Datasheet](#) | [Product page](#) | [Application notes](#) | [Resources](#) | [Get samples](#) | [Contact us](#) ]

**Package:**  
STQFN-12

**Supported Development Platforms:**

- Software Simulation
- GreenPAK Advanced Development Board (SLG4DVKADV) + Logic Level Adapter #1 + GreenPAK TQFN-12 #1 (SLG4SA12-16x16)
- GreenPAK Lite Development Board (SLG4DVKLITE) + GreenPAK TQFN-12 #1 (SLG4SA12-16x16)

**Description:**  
The SLG47512V provides a small, low voltage and low power component for commonly used mixed-signal functions. The user creates their circuit design by programming the one time programmable (OTP) Non-Volatile Memory (NVM) to configure the interconnect logic, the IO Pins, and the macrocells of the SLG47512V. This highly versatile device allows a wide variety of mixed-signal functions to be designed within a very small, low power single integrated circuit. The macrocells in the device include the following:

- Two High Speed General Purpose Analog Comparators (ACMPxH);
- Integrated Voltage References (Vref);

At the bottom right of the window, there are three buttons: 'New', 'Open', and 'Close'.

Go Configure Software Hub User Interface

## 2.1.1 Interface overview

The basic interface elements are *main menu*, *toolbar*, *work area*, *work area controls*, *properties panel*, and *component list*.

### Main menu

After you select the Part Number and start the project, you can see the menu bar with the following items: *File*, *Edit*, *View*, *Tools*, *Options* and *Help*. See the full description of all the menu commands in section 6.1 [Main menu commands](#).

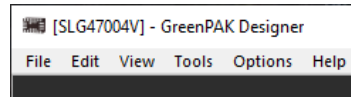

**Main menu**

### Toolbar

The toolbar items are located under the menu bar by default. Move, show, and hide toolbar items to customize the environment. Use [Settings](#) to reset the *Appearance*.

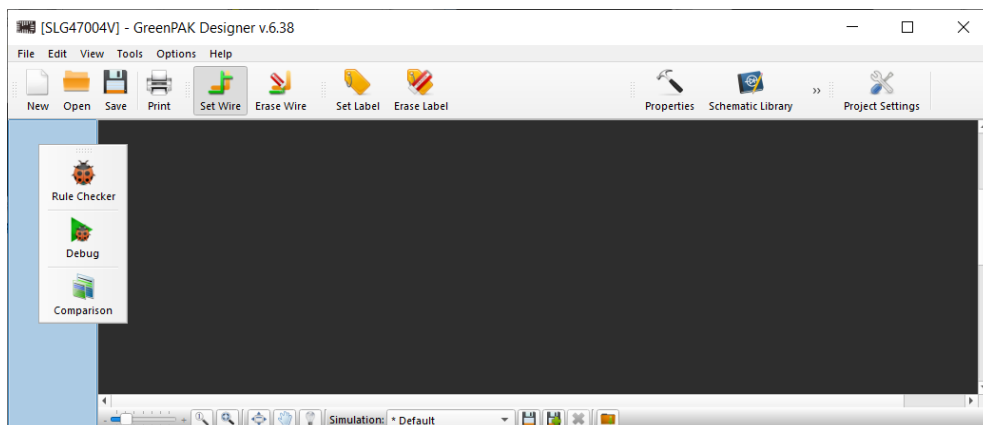
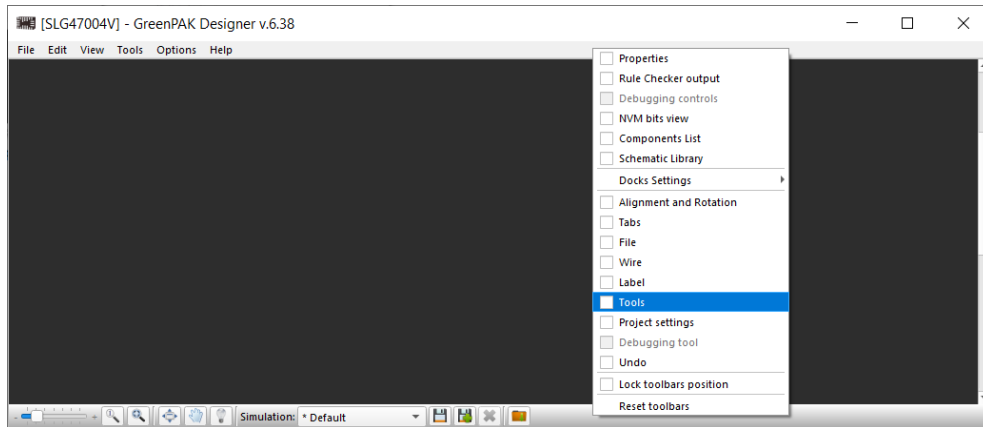

**Toolbar customization**

## Work area

The work area displays the selected **components** (macrocells) from the component list and the **connections** between them. The Part Numbers contain different sets of macrocells, therefore the IDE's interface varies.

The IDE may contain one or two work areas (an example of Part Number with two work areas is SLG46620V).

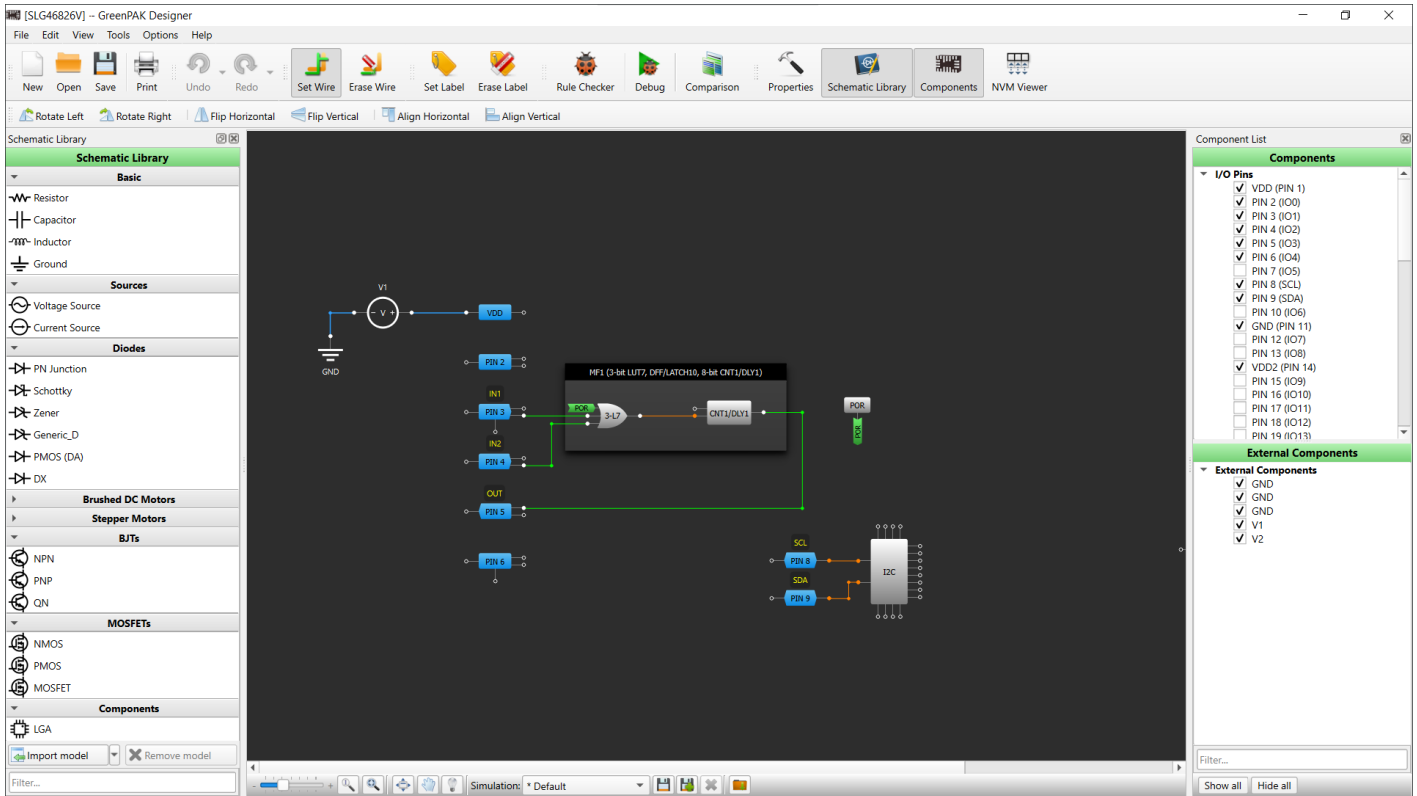

Part Number with one work area

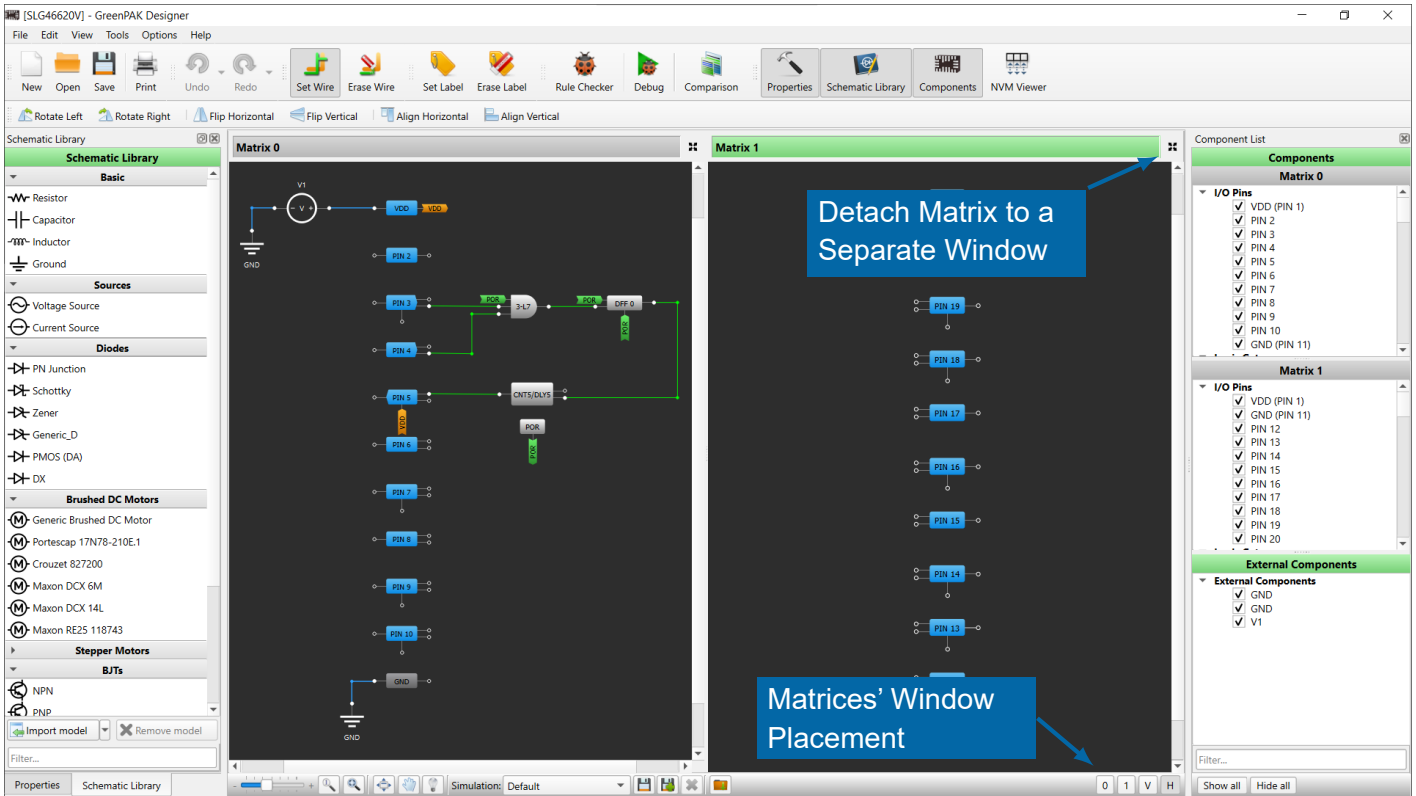

### Part Number with Two Work Areas

The Part Numbers with two work areas have several distinctive buttons, which define the matrix window placement:



### Matrices' window placement

- 0 — only *Matrix 0* is displayed
- 1 — only *Matrix 1* is displayed
- V — both matrices are displayed vertically (on top of each other)
- H — both matrices are displayed horizontally (beside each other)
-  — makes one of the matrices a separate window

The *Matrix* title bar turns green when the work area is in focus.

### Work area controls

You can find the additional work area controls on the bottom toolbar.

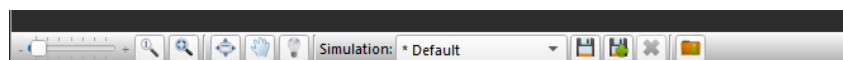

### Work area controls



Adjust the work area (zoom, fit the work area or make it full-screen)



Enable the *Pan mode* to move the work area (click and hold the middle mouse button as an alternative)



Activate the possibility to see the hint box with the block's property info upon hovering the mouse over a component

## Component list

This panel contains a list of available macrocells in a chip. You can show, hide, or search for the components via the list.

Show/hide a component by using the checkbox next to its name.

Drag and drop a block from the list to the work area.

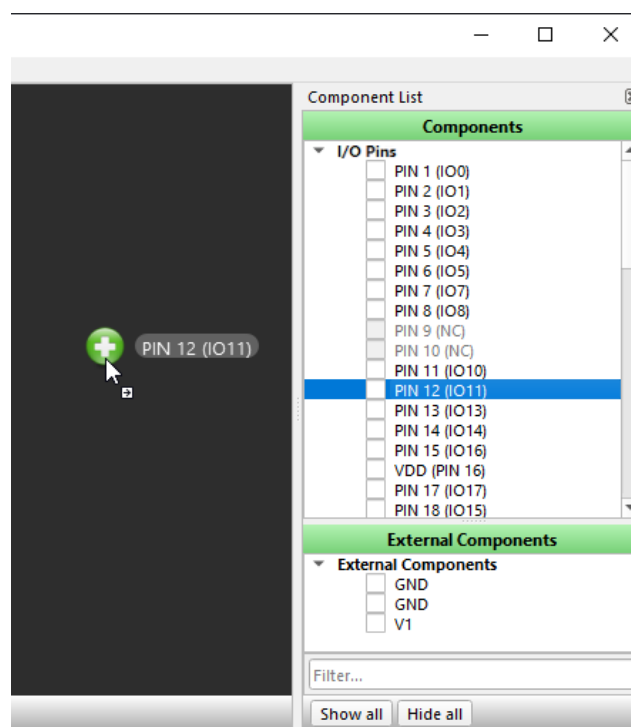

### Checkbox / Drag and Drop

You can use filter to easily search for the required component. Show/hide all the components by using *Show all* and *Hide all* buttons.

**Note 1:** A hidden component retains the configurations set on its properties panel (see more info about the [Properties](#) panel).

**Note 2:** It is not possible to hide connected blocks (see sections [2.1.4 Components](#) and [2.1.5 Connections](#) to find out more).



## Properties panel

The panel contains all settings available for a selected component. The set of properties may vary depending on the macrocell.

The *Properties* panel may contain:

- Settings and parameters that can be specified for a selected block
- Settings that control the predefined connections to a selected block

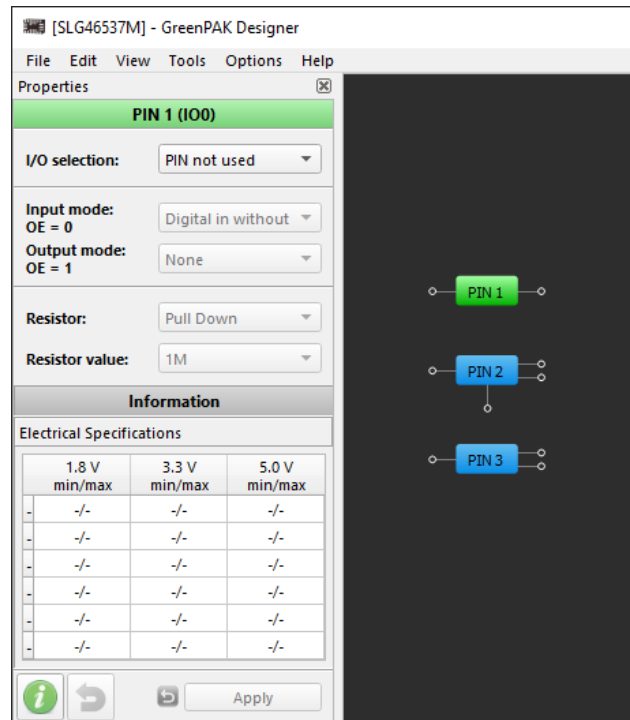

**Properties panel**

Once you change the property values, you can *Apply* or *Revert* the modifications.

After changes are applied, it is possible to *Reset* the changes. The following options may be available: *Reset connections to default*, *Reset settings to default* or *Reset configurations to default* (the latter is available only for the components with more than one mode, e.g. LUT).

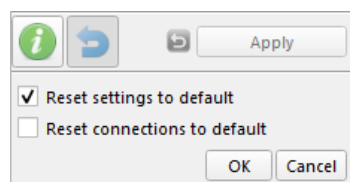

**Property reset feature**

You can also *Reset* the block via the component's context menu.

## 2.1.2 Working with project files

A project file is the latest saved state of the designed project. The file contains component configurations, connections between blocks, component location on the work area, etc.

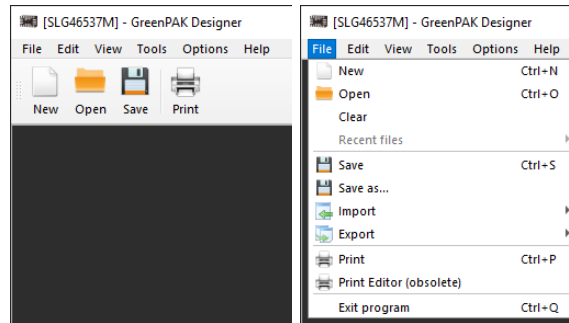

**File operations**

### Create/Save/Open a project

You can start a new project from the *Hub* window (click the Part Number → *New*) or from an opened instance (click the *New* icon on the toolbar or *File* → *New*)

**Note:** For the *FPGA* Part Number (e.g. SLG47910), once you select it from the Part Numbers list in the *Hub* window, you will be prompted to create the project via the *New Project* window. Upon clicking *Create*, the *FPGA* project directory will appear in the specified location.

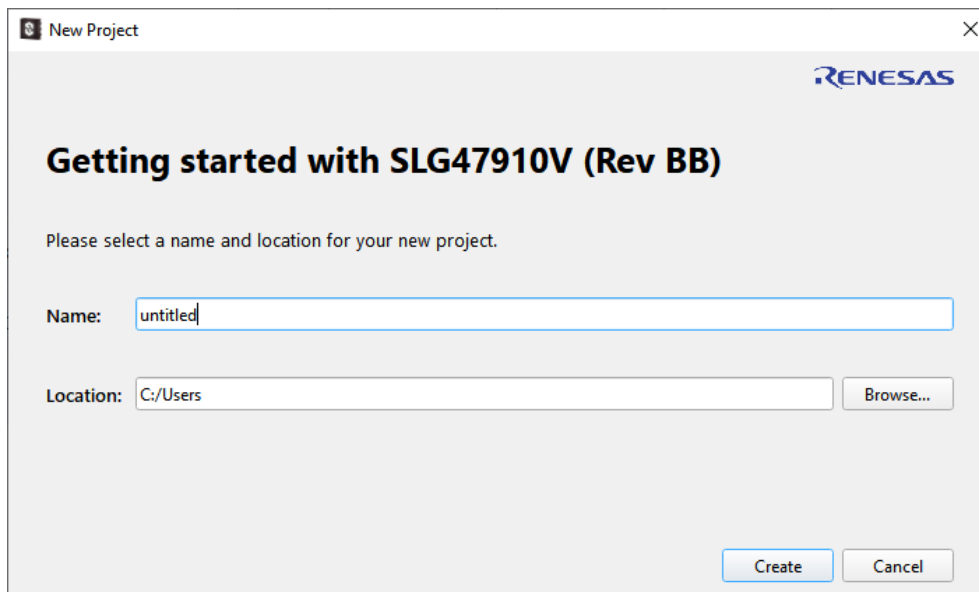

**Window for FPGA project creation**

Once you start a new project, the *Project settings* window appears. You can skip this step, but once the data is needed, you'll be asked to fill it in again. Read more about *Project settings* window later in this section.

The default project (state of the work area right after you open a new project) is usually configured for minimal power consumption. That is why some components are disabled.

To save your project click the *Save* icon on the toolbar, or click *File* → *Save/Save as*.

Change the folder to which the project is saved in *Settings*.

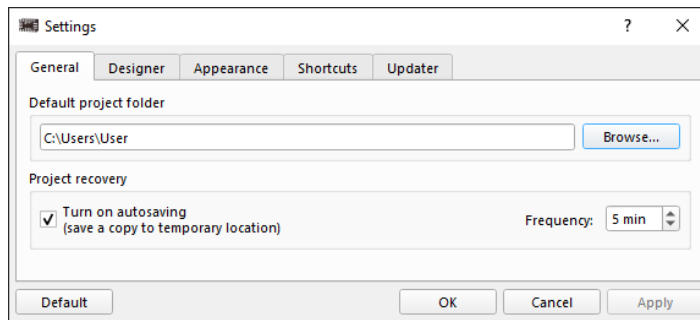
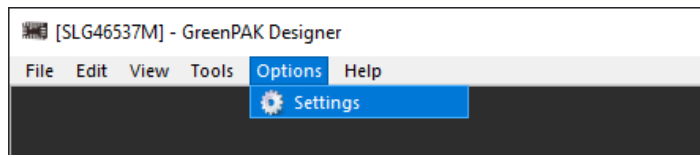

### Project file folder

The supported project file extensions are: *.aap*, *.can*, *.gp3*, *.gp4*, *.gp5*, *.gp6*, *.hvp*, and *.ppak* (*.gp1*, *.gp2*, *.gpp* and *.ldo* are the obsolete file extensions).

There are several ways to open a project file:

- *Open* button on the *Hub* window
- *Open* icon on the toolbar (or *File* → *Open*)
- Drag and drop the project file to the *Hub* window
- Drag and drop the project file to the work area
- Double-click the project file

It is also possible to open multiple project files at once using drag and drop feature.

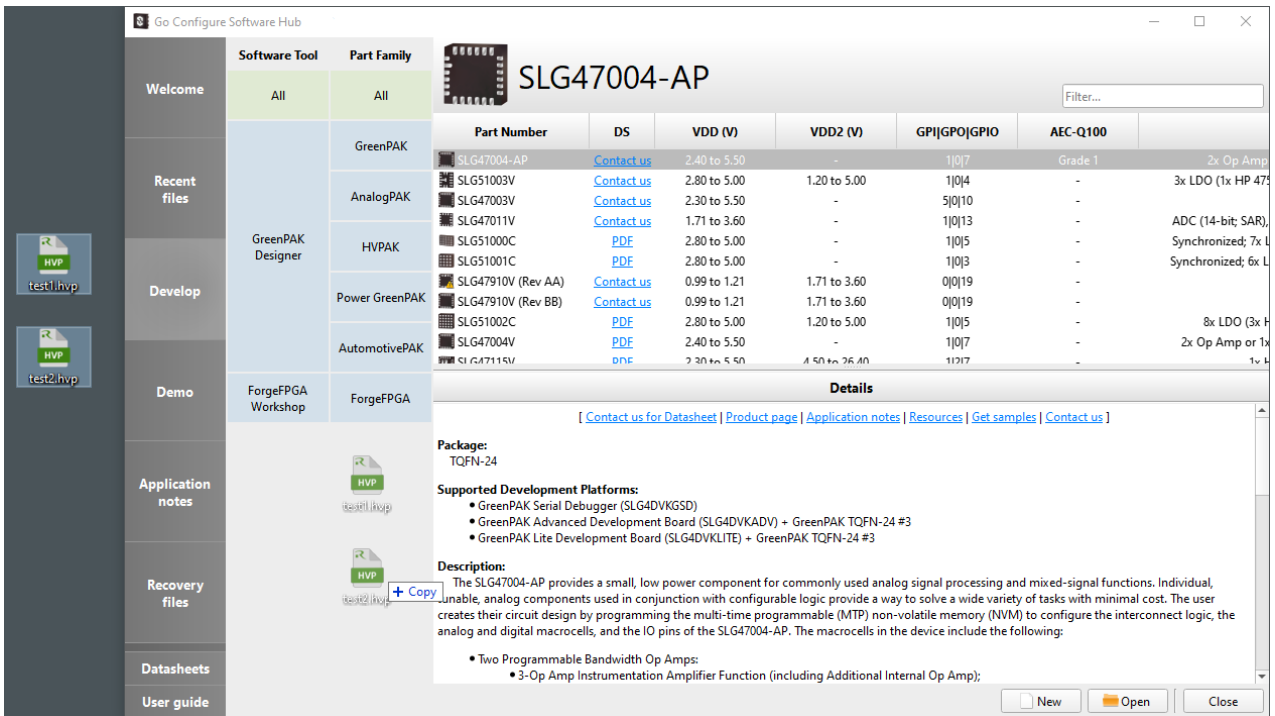

## Open a project file

**Note:** It is highly recommended not to make manual changes in the file to prevent from its corruption.

## Project settings window

As mentioned earlier in this section, the *Project settings* window appears right after you start a new project. It contains four tabs: *Specs*, *Information*, *General*, and *Security*.

## Specs

In *Specs*, you can see the fields to fill in the chip operating conditions, such as VDD and Temperature (Min., Typ. and Max). The Part Numbers may have one or multiple VDDs. Click the blue *information* button to see the recommended range within which the chip can operate safely.

The Part Numbers may support different packaging. The package can also be selected in the *Specs*

tab.

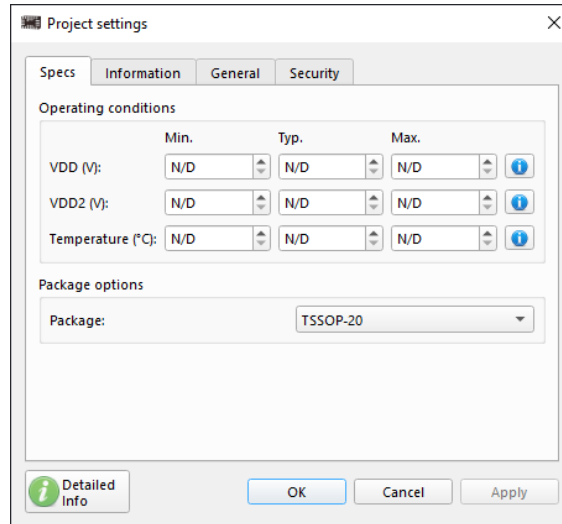

**Project settings window examples**

**Note:** You can close the *Project settings* window without entering the operating conditions. Working with *Simulation* or hardware development platforms in the *Debug tool* requires entering the specs. Once you click *Debug* on the toolbar while specs are not specified, a warning notification to add specs appears. Click the *OK* button on the warning window or the *Project Settings* icon on the toolbar to enter specs.

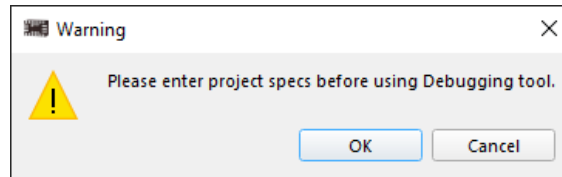

**Warning to add specs to use Debug tool**

In case the improper operating conditions are filled in, a warning with the corresponding text message will appear. Some warning notifications do not stop you from applying the specs, while

others require to fix them before the application. Here are the warning examples:

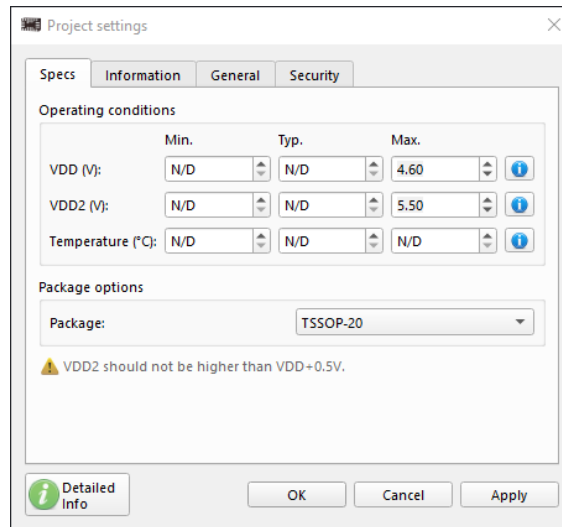

### Specs-related warning examples

If e.g. Min. value is higher than Typ., and in other similar cases, the affected fields become highlighted in red. The specs cannot be applied until the issue is fixed.

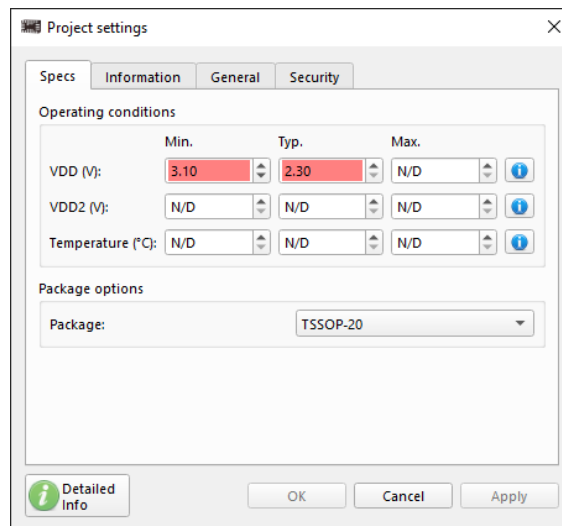

### Improper specs values

## Information

The *Information* tab contains the short piece of information about the Part Number. To see the info, click the *Info* button.

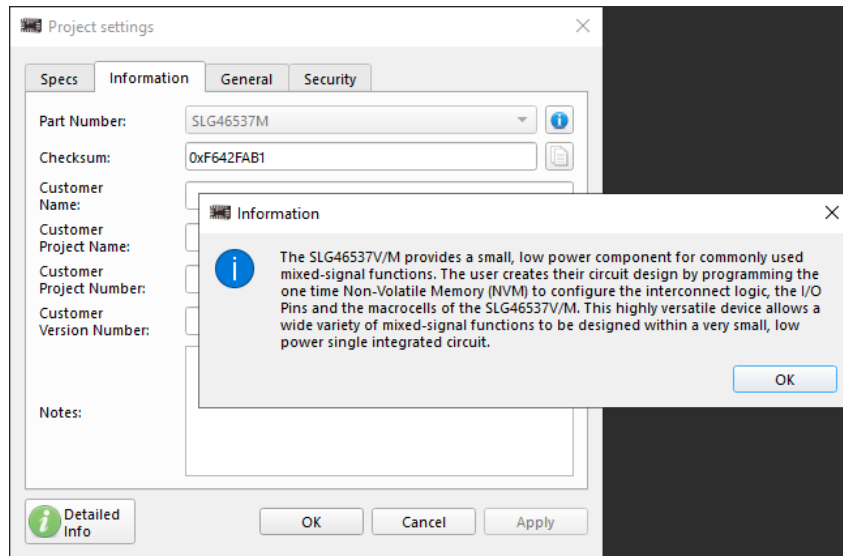

### Information tab

The *Checksum* field value is generated based on OTP bits state in *NVM* and is written to the project file. For *FPGA* Part Numbers (e.g. SLG47910), in addition to OTP bits, the *FPGA* core configuration bitstream is also taken into account during calculations.

You can also see the input fields to fill in the information about the project. The entry in *Customer project name* field is also displayed in *Print Preview*.

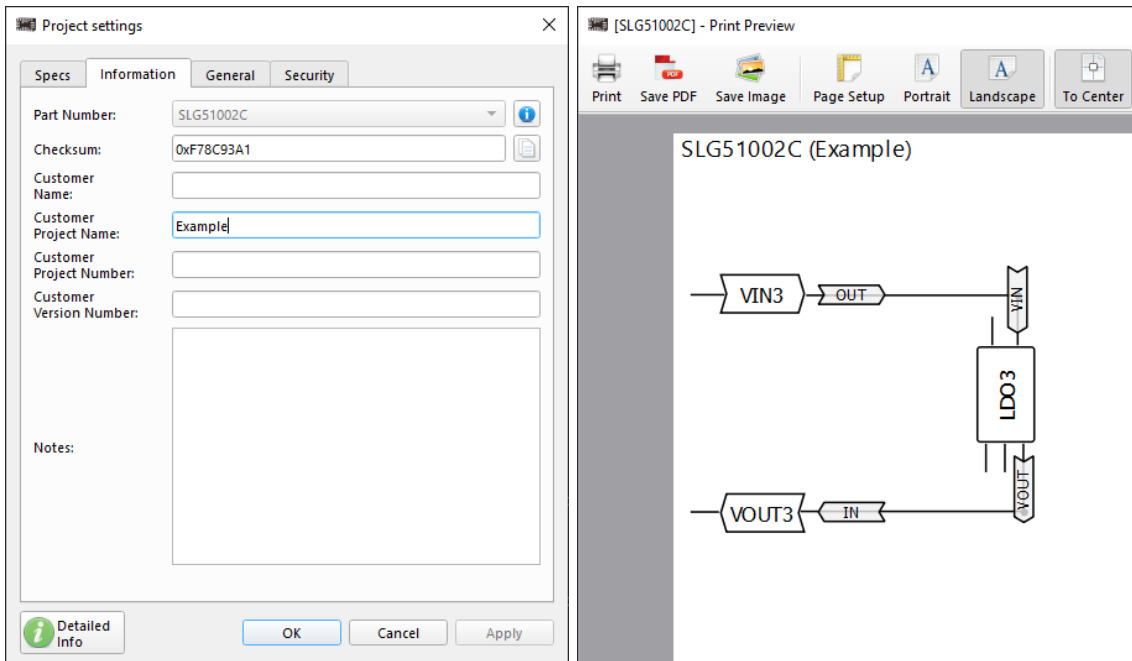

### Customer project name in Print Preview

## General

The *General* tab contains the global chip configurations. The set of settings varies depending on the Part Number.

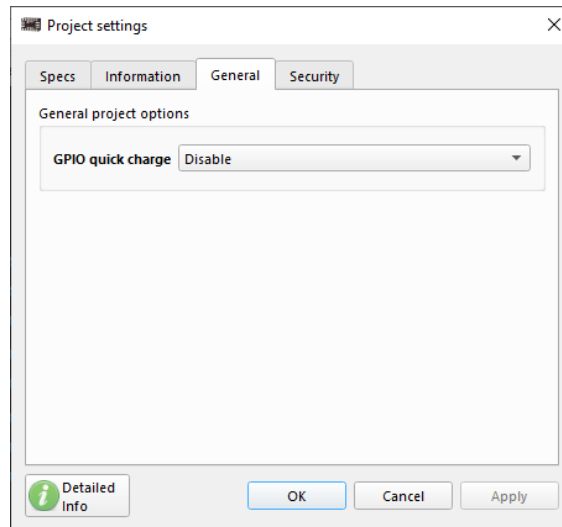

**General tab**

## Security

Same as *General*, the *Security* tab includes global settings which typically grant access to the chip's data protection features. The common and important *Security* tab configurations are as follows:

- ▶ *Lock status* — allows to protect read/write chip operations
- ▶ *Pattern ID* — can be used for project versioning (the *Pattern ID* data can be read even for chips with read protection enabled)

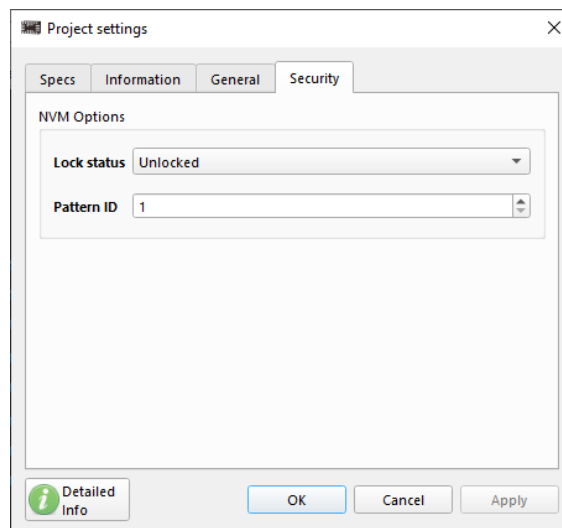

**Security tab**

To find out more about the particular chip configurations, click the *Detailed info* button on the *Project*



settings window or access the Datasheets through the [Hub](#) window.

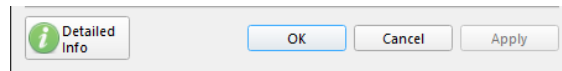

**Detailed info button**

### 2.1.3 NVM viewer

The non-volatile memory (NVM) tool represents the permanent memory of a chip. The NVM is grouped into bytes. Each byte is an 8-bit sequence. Above each byte, you can see the information about the byte's address along with its value in hexadecimal and decimal formats. NVM changes occur after the macrocell's property modifications or setting a [connection](#) between the [blocks](#).

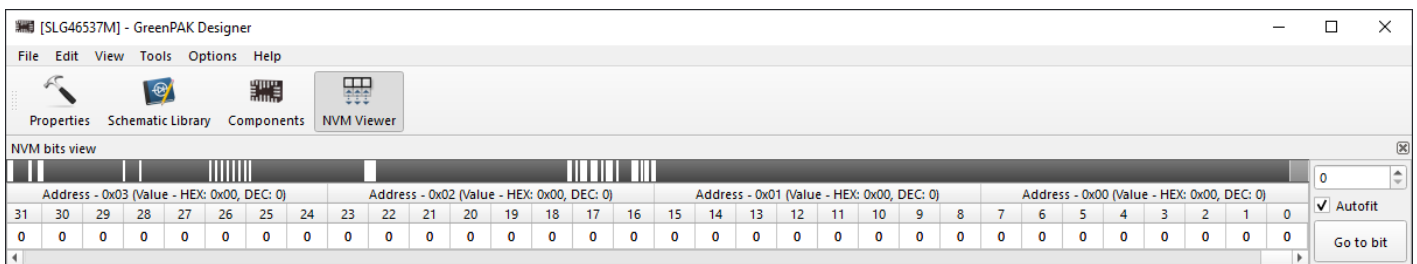

**NVM viewer**

NVM viewer cells can be in the in the following states:

- 0 bit range of a selected block
- 0 bits with 0 value
- 1 bits with 1 value
- 0 latest bit changed to 0 value
- 1 latest bit changed to 1 value

You can also use the *NVM viewer* controls for quick navigation through the bit table. Use the *Autofit* feature to jump directly to the bit range of the selected component.

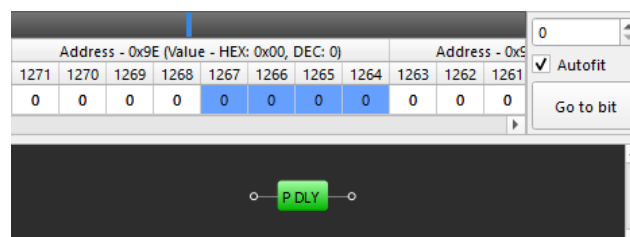

**Autofit**

Click *Go to bit* once you enter a bit number (in the decimal format) to find the bit you need. The bit

order number becomes highlighted after clicking a bit or using the *Go to bit* button.

Address - 0x0C (Value - HEX: 0x00, DEC: 0)								Address - 0x0B (Value - HEX: 0x00, DEC: 0)				
103	102	101	100	99	98	97	96	95	94	93	92	91
0	0	0	0	0	0	0	0	0	0	0	0	0

**Bit order number highlight**

The *NVM viewer* navigation bar can also orient you to the location of selected or changed bits in the table (the color on the bar corresponds the cells color described above). In addition, black color represents 0 and white shows 1 values.

Address - 0xA9 (Value - HEX: 0x04, DEC: 4)							Address - 0xA8 (Value - HEX: 0x07, DEC: 7)							Address - 0xA7 (Value - HEX: 0x00, DEC: 0)									
1359	1358	1357	1356	1355	1354	1353	1352	1351	1350	1349	1348	1347	1346	1345	1344	1343	1342	1341	1340	1339	1338	1337	1336
0	0	0	0	0	1	0	0	0	0	0	0	0	1	1	1	0	0	0	0	0	0	0	0

**NVM viewer top bar**

Hover the mouse cursor over the bit to see which macrocell this bit belongs to.

Address - 0x92 (Value - HEX: 0x00, DEC: 0)								Address - 0x91 (Value - HEX: 0x18, DEC: 24)							
1175	1174	1173	1172	1171	1170	1169	1168	1167	1166	1165	1164	1163	1162	1161	1160
0	0	0	0	0	0	0	0	0	0	0	1	1	0	0	0

**NVM hint**

You can save or load the NVM sequence by clicking *File* → *Import/Export* in the main menu (see the description of all main menu items in section 6.1 Main menu commands). If the imported file contains a different bit sequence length than the selected Part Number, the corresponding pop-up appears and it is possible to proceed with loading the data.

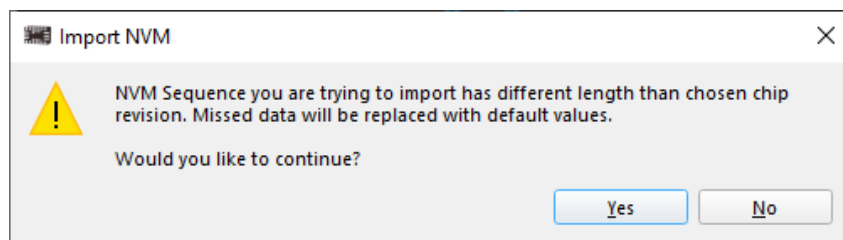

**Import different NVM sequence length**

### 2.1.4 Components

After you add a macrocell from the [component list](#) to the work area, you can choose how to interact with it. Move the component(s) use a mouse or a keyboard (see section 6.2 Keyboard and mouse controls). You can also use the toolbar widgets to rotate, flip, and align the selected block(s). To

select more than one block click, hold, and drag over the components you want to select.

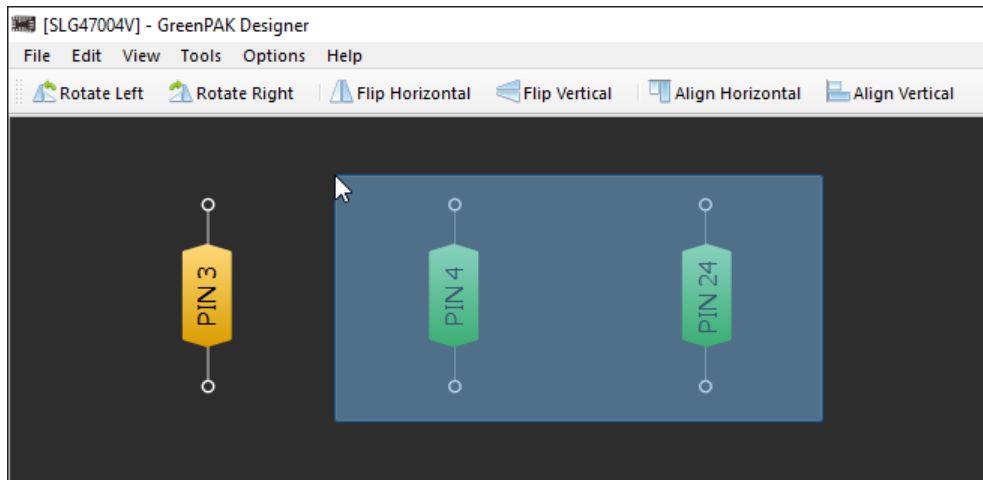

**Selected block adjustment**

### GreenPAK chips components highlight

The macrocell color gives you information about its mode (enabled/disabled) and state (deselected/selected). Input/Output (I/O) Pin block's color informs about its relation to a particular VDD.

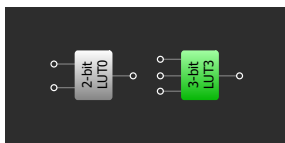

enabled, deselected/selected

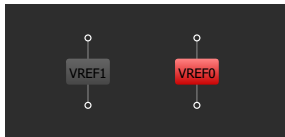

disabled, deselected/selected

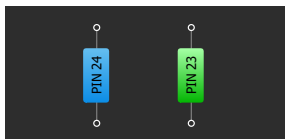

Pin, deselected/selected

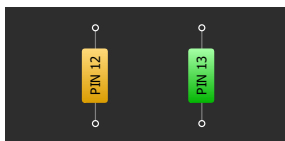

Pin for connection with VDD2 (analog), deselected/selected

You can connect macrocells via the pins.

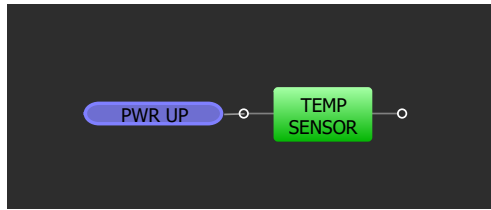

Hover the cursor over the block to see the pin hints. For more info about managing pin hints

behavior, refer to section [2.1.7 Settings](#).



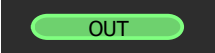
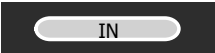
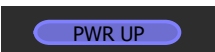

**Pin hint**

Macrocell pin hint color indicates the connection possibility between the blocks: whether a wire can or cannot be added, or which connection type can be set.

-  open for connection
-  connection limit is reached
-  temporarily closed for connection (you can change macrocells properties to make it available for connection)
-  used for hard-wired connections
-  external IN/OUT

Read about connection types in section [2.1.5 Connections](#).

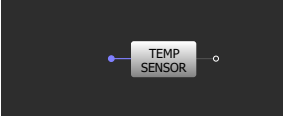
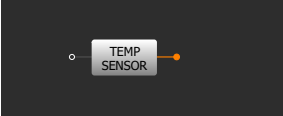
When you are in the process of setting a connection, you can see the pin highlight. Just like pin hint color, the pin color indicates the connection possibility.

-  open for connection
-  temporarily closed for connection (you can change macrocell settings on its [Properties](#) panel to make it available for connection)
-  used for hard-wired connection
-  connection is not allowed

## SLG51000/1 chip components highlight

Component highlight for SLG51000/1 chips in different modes or states is as follows:

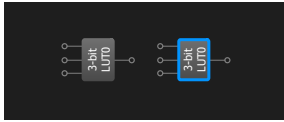

enabled, deselected/selected

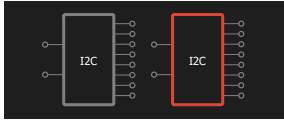

disabled, deselected/selected

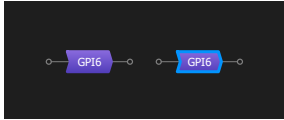

I/O Pin, deselected/selected

Pin and pin tip colors are the same as for chips described above.

### 2.1.5 Connections

The *Set Wire* widget helps you to set a connection between the blocks. To add a wire, click two pins between which you are setting a connection. More than one connection set from one OUT pin is a network. You can dismiss connection creation by clicking the right mouse button.

To remove the connection, enable the *Erase Wire* tool and click the wire (you can also delete the connection or network via the context menu, triggered by right-clicking the wire).

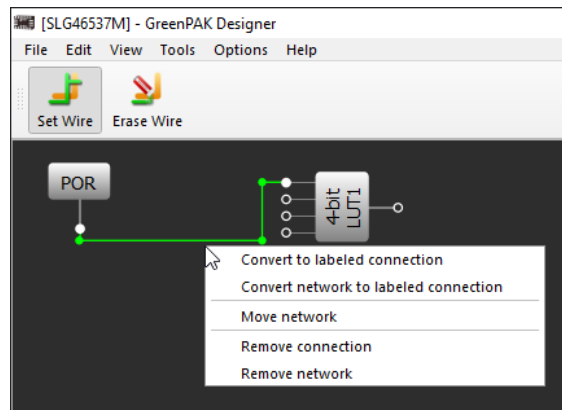

**Set/Erase wire/network**

## GreenPAK chips connections highlight

While working with different Part Numbers you may encounter the following component connection types:

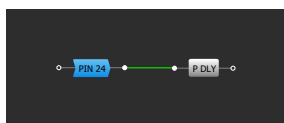

*Matrix*

the most common connection which can be set between green pins

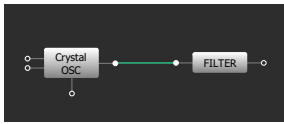

*Shared*

matrix connection which is physically shared with more than one component

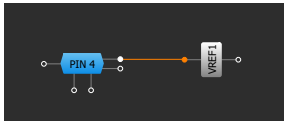

*Hard-wired*

connections which are predefined and depend on block settings

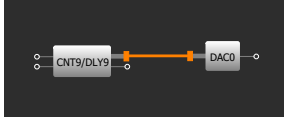

*Bus*

same as hard-wired

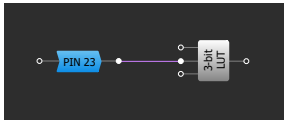

*State dependent*

connections set to state dependent components (e.g. *Dynamic Memory*, *F* or *State blocks* within ASM subsystem in SLG46880V chip)



*External*

connection set from/to external components (read more in section 2.4.2 [External components](#))

### SLG51000/1 chip connection highlight

In SLG51000/1 Part Number there are two connection types:

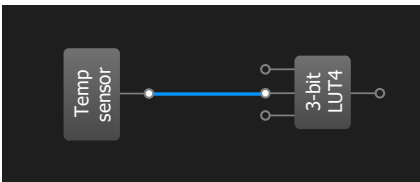

*Matrix*

the most common connection which can be set between green pins

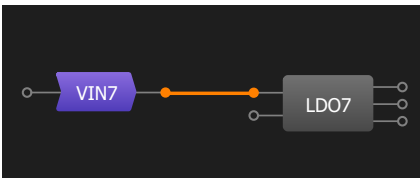

*Hard-wired*

connections which are predefined and depend on block settings

### Common connection-related behavior for all Part Numbers

A wired connection/network can be converted to labeled one. Trigger the context menu upon right-clicking the wire to see such option.

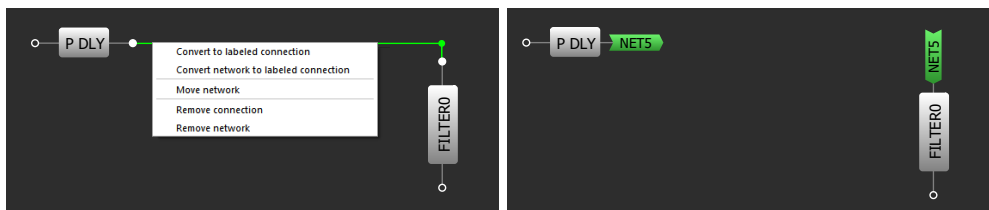

**Convert a wire to label**

After conversion, the label color remains the same as its wired version (Exception: different connection types set from one OUT. In this case, label is yellow. Applicable only to *GreenPAK* Part Numbers). Labels and pin colors during connection are also the same.

The connections can be labeled by default, but you can change them to wired upon need. You can also change the labeled connection's name. Double-click the label and enter a new name in a pop-up window.

After hovering the mouse over a label, it becomes highlighted along with all other parts of the same connection/network.

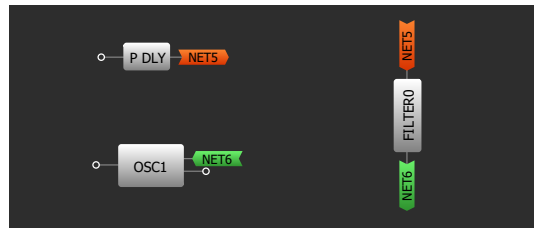

**Highlighted label**

You can also see the hint with the connection or network info upon hovering the cursor over the wire or label.

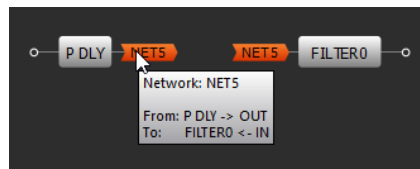

**Connection/Network hint**

You can move the connection/network to another OUT. Select *Move network* from the context menu. Choose the new component in a *Move network* window and click *Move*.

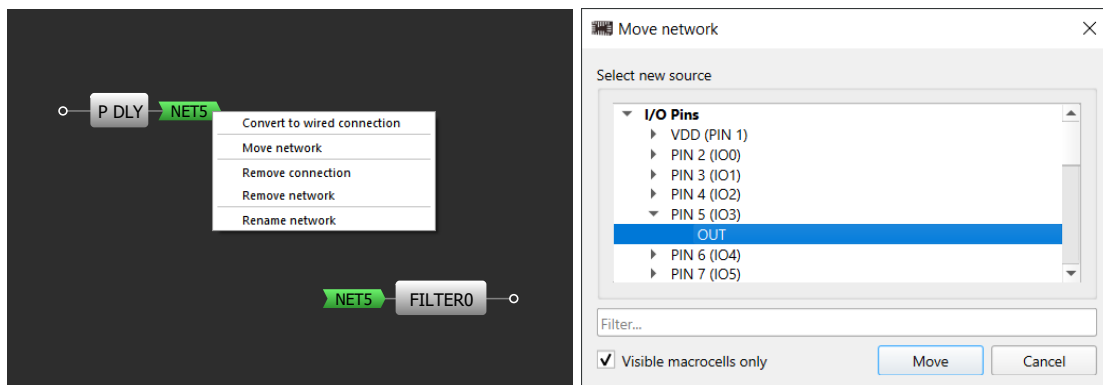

**Move connection/network**

The information about the components, pins, connections colors and their description is also present in *Go Configure Software Hub*, in *Legend box*. You can read more in section [2.1.8 Legend box](#).

## 2.1.6 Keyboard commands

There are configurable and non-configurable keyboard commands. The configurable commands can be managed in *Settings* (for more info, see section 2.1.7 *Settings*). To find the command easily, use the search field.

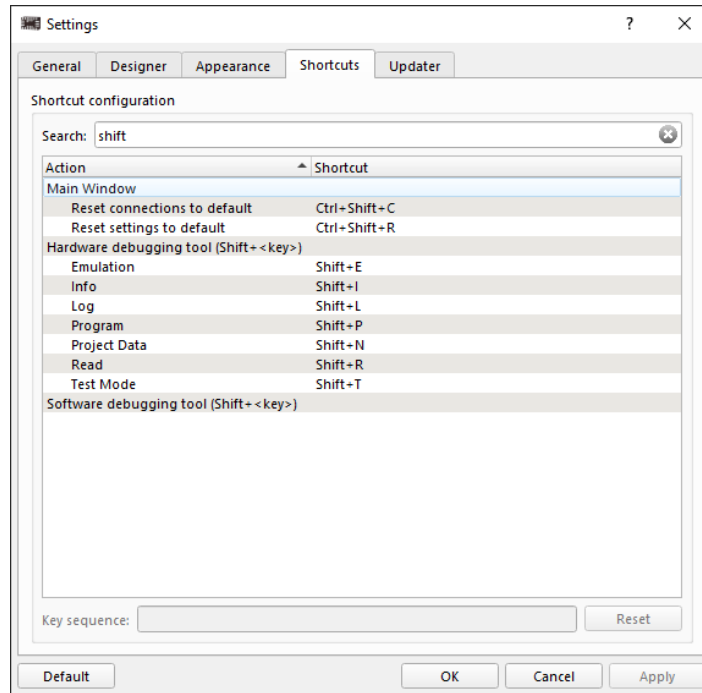

**Shortcuts table**

To change or add a shortcut, double-click the action and press the key sequence on your keyboard to add it to the corresponding field. To discard changes, use the *Reset* button.

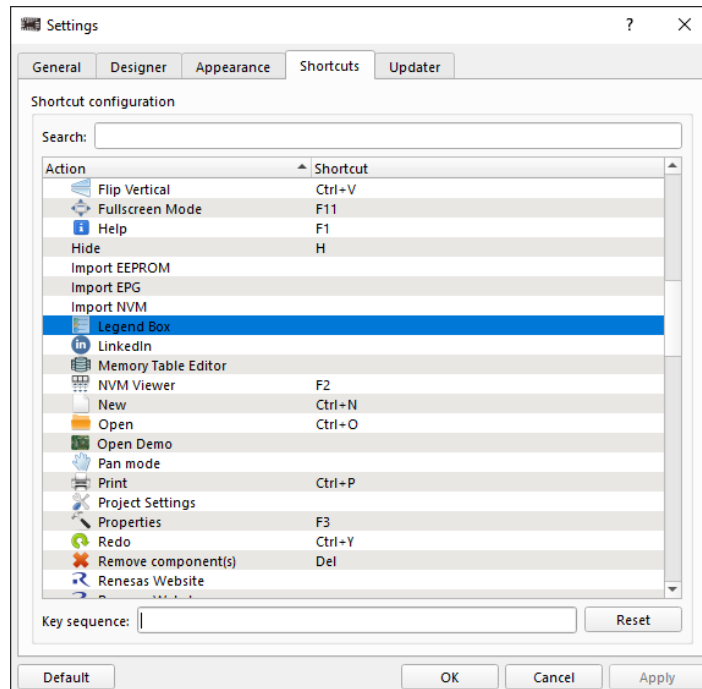

**Assign/Change shortcut**



In *Debug tools*, you can assign a hotkey to some hardware sources via the context menu. Use a hotkey to change the source state (read more in section [2.2 Debug tools](#)). Assign a hotkey from the context menu or create a custom one.

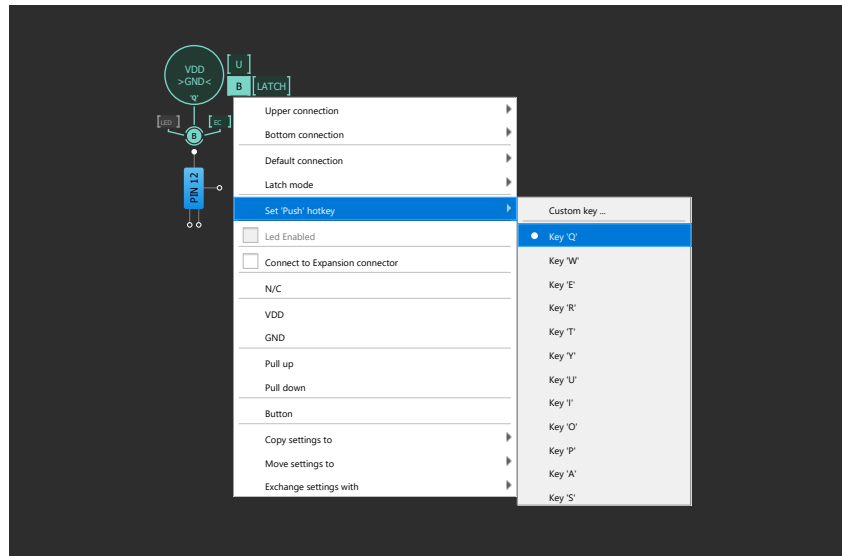

**Hardware sources hotkeys**

See the list of configurable and non-configurable hotkeys in section [6.2 Keyboard and mouse controls](#).

### 2.1.7 Settings

To reach the settings window open *Options* → *Settings* (on macOS open *App menu* → *Preferences*). The window contains the following tabs: *General*, *Designer*, *Appearance*, *Shortcuts*, and *Updater*.

#### General

- *Default projects folder* — define the path to your project files
- *Projects recovery* — activate project file autosaving

This feature reduces the risk or impact of data loss in case of a crash or freeze. The project file copy is saved to a temporary location at a predefined interval. If a critical issue occurs, the file appears in the *Recovery Files* tab in the *Hub* window (see the location of the *Recovery files* tab in section [2.1 Design tools](#)).

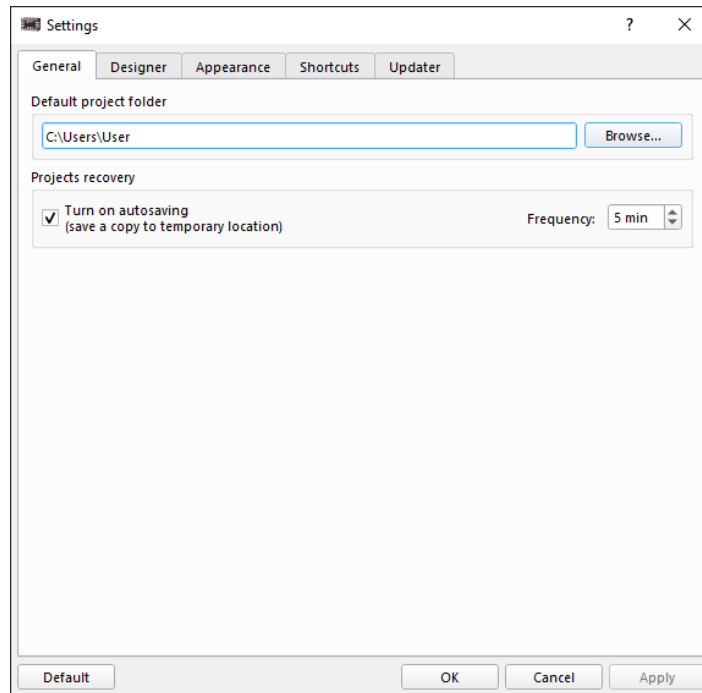

**General tab**

## Designer

- *Pin hints* — show pin hints while a block is selected or the properties panel of a component is visible (find out more about pin hints in section [2.1.4 Components](#))
- *Look-Up Table (LUT)* — select the preferred LUT shape (regular, ANSI or IEC) using different standard gates

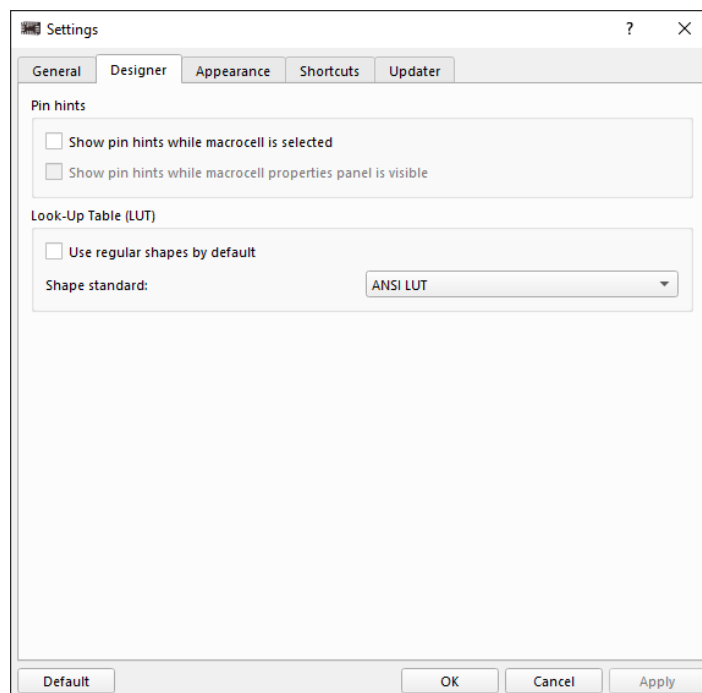

**Designer tab**

## Appearance

- ▶ *Window appearance* — save position of the toolbars/dock widgets and window geometry of the workspace
- ▶ *High DPI displays* — enable *Go Configure Software Hub* scaling on high DPI displays

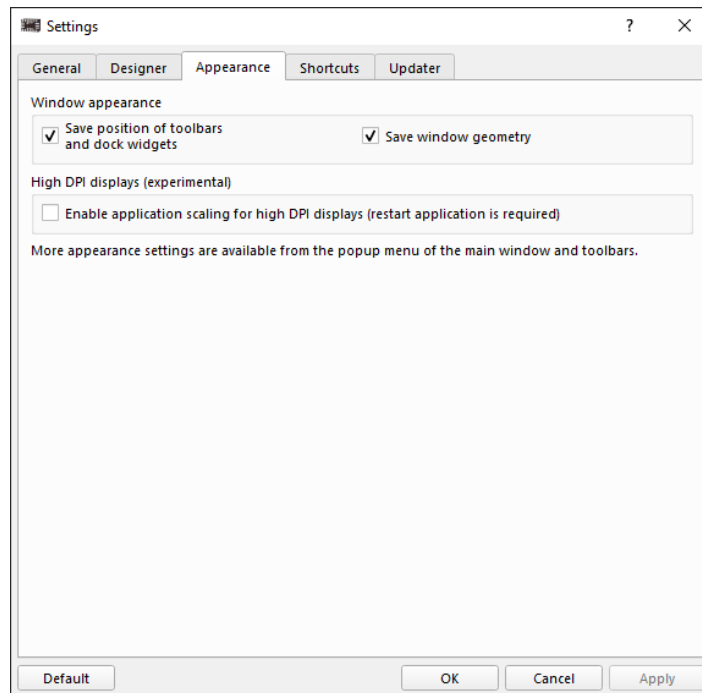

**Appearance tab**

## Shortcuts

- ▶ *Shortcuts configuration* — assign/change the shortcut for the available actions

Read more about shortcuts in section [2.1.6 Keyboard commands](#).

## Updater

- ▶ *Scheduler* — set frequency of the updates check
- ▶ *Path* — define a location to download updates to
- ▶ *Proxy* — configure a proxy for updates

► *Check configuration button* — test the connection to the server

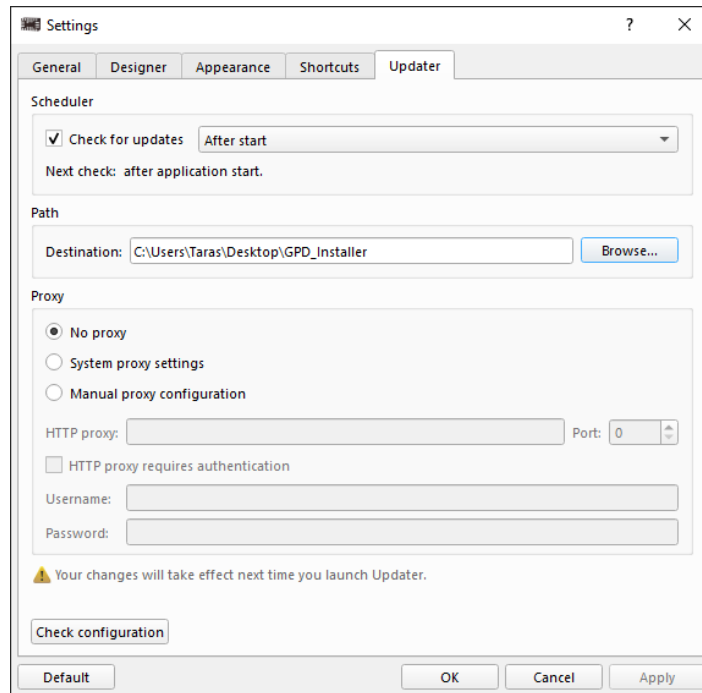

**Updater tab**

In order to reset the settings, click *Default* button at the bottom left corner of the *Settings* window. You can reset settings for a particular category or all categories at once.

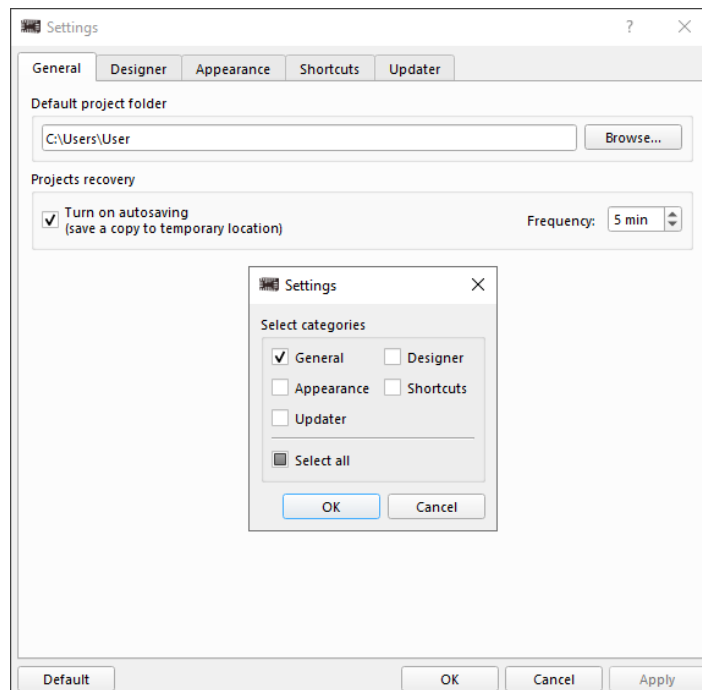

**Default button**

## 2.1.8 Legend box

The *Legend box* window shows the color scheme of the components and connections-related features in *Go Configure Software Hub*. The *Legend box* view may vary depending on the Part Number. You can find it in the main menu, *Help* → *Legend box*.

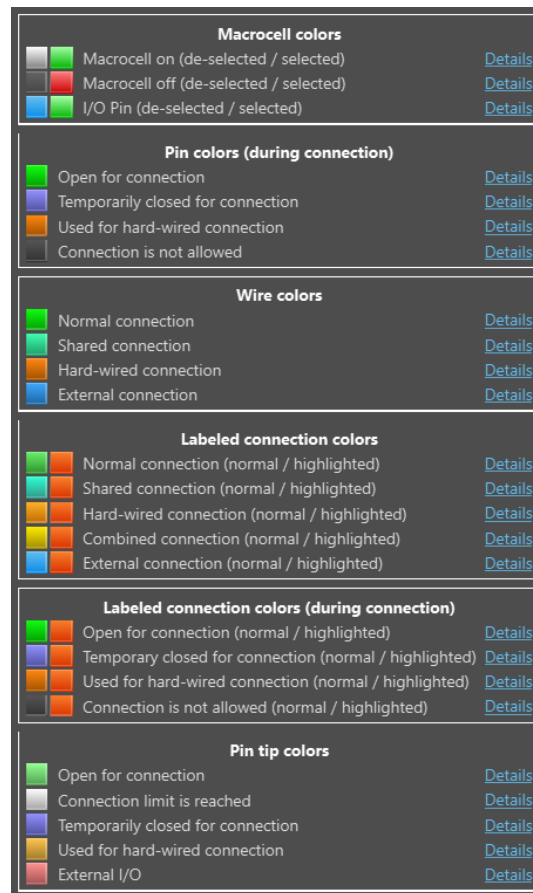

**Legend box**

Find out more in sections [2.1.4 Components](#) and [2.1.5 Connections](#).

## 2.1.9 Help window

Help materials provide information about the IC's parameters, components, and tools. There are several ways to reach the *Help* window.

If you prefer to open the unified *Help* materials for a particular Part Number, go to the main menu

→ *Help* → *Help* (F1). Walk through the categories to find the information you need.

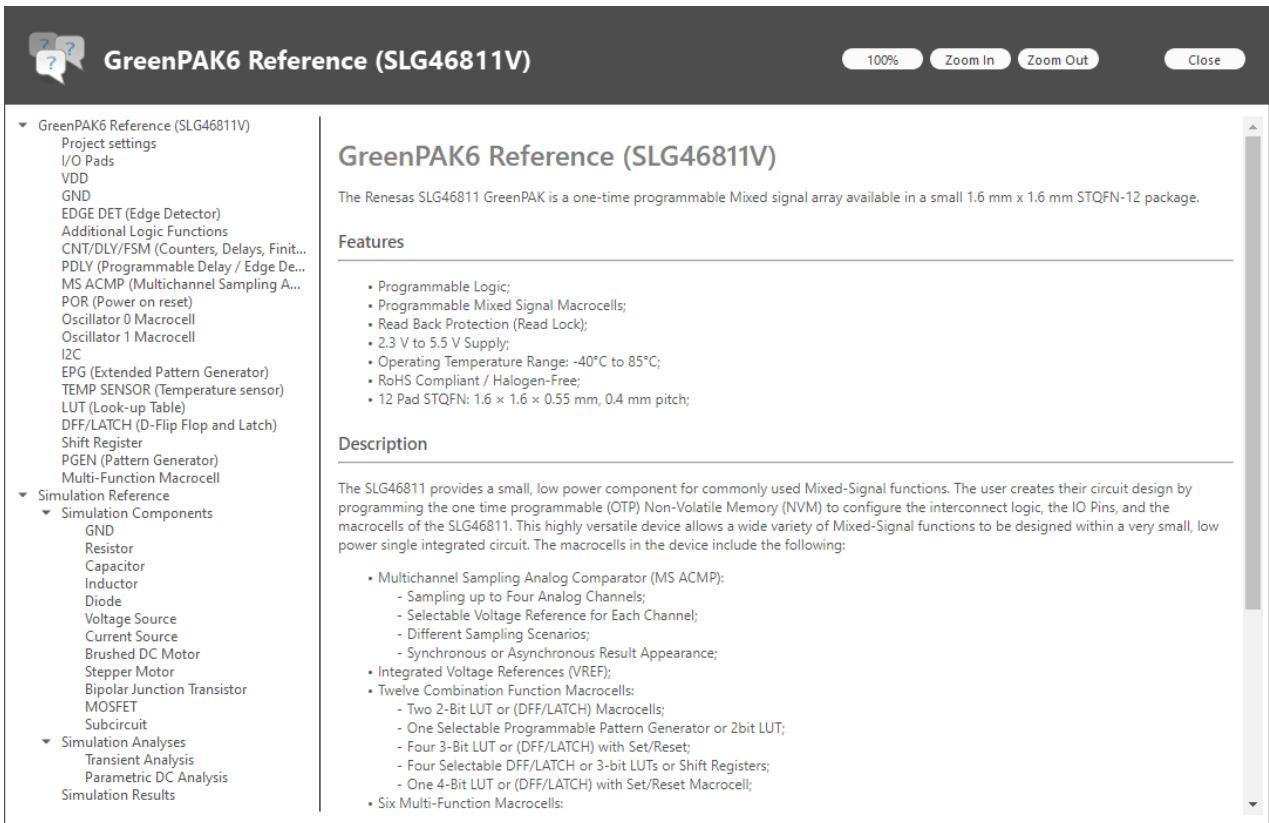

## Help window

To open the *Help* window for a selected block, right-click the component and select the *Detailed info*  option (F1) in the context menu.

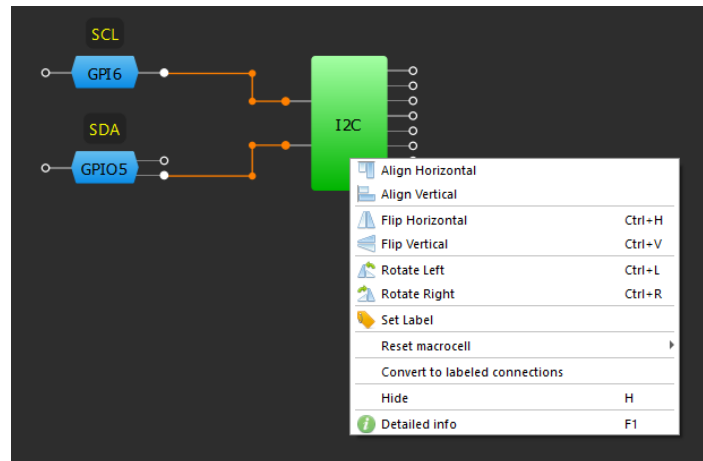

## Detailed info

You may also see the information buttons () in different workspace locations, e.g., on a component's *Properties* panel or *Project settings* window. Clicking the button also opens the *Help* window.

## 2.1.10 Snipping tool

*Snipping tool* is a work area screenshot-maker. You can find the tool in the main menu, *Tools* → *Snipping tool*.

Choose between the *Datasheet* and *Regular* screenshot style (the *Datasheet* style view is the same as in *Print Preview*)

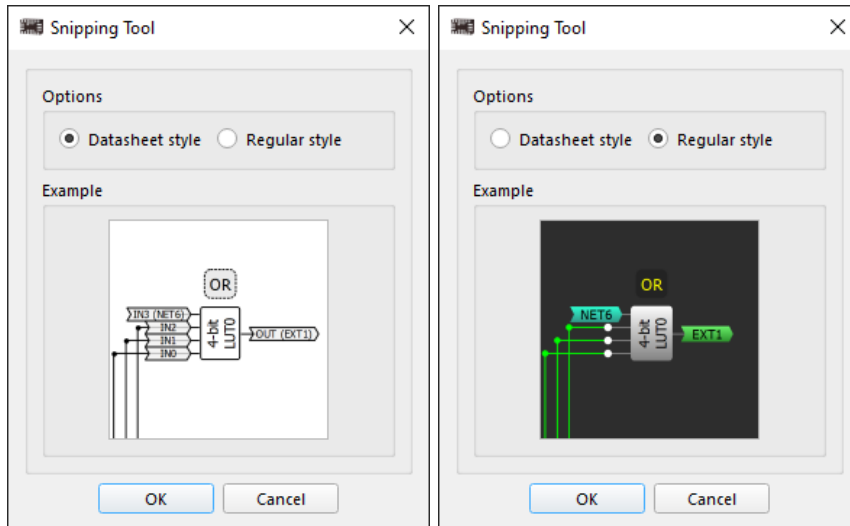

**Screenshot style**

Once you select the area, copy/save the file in the supported format.

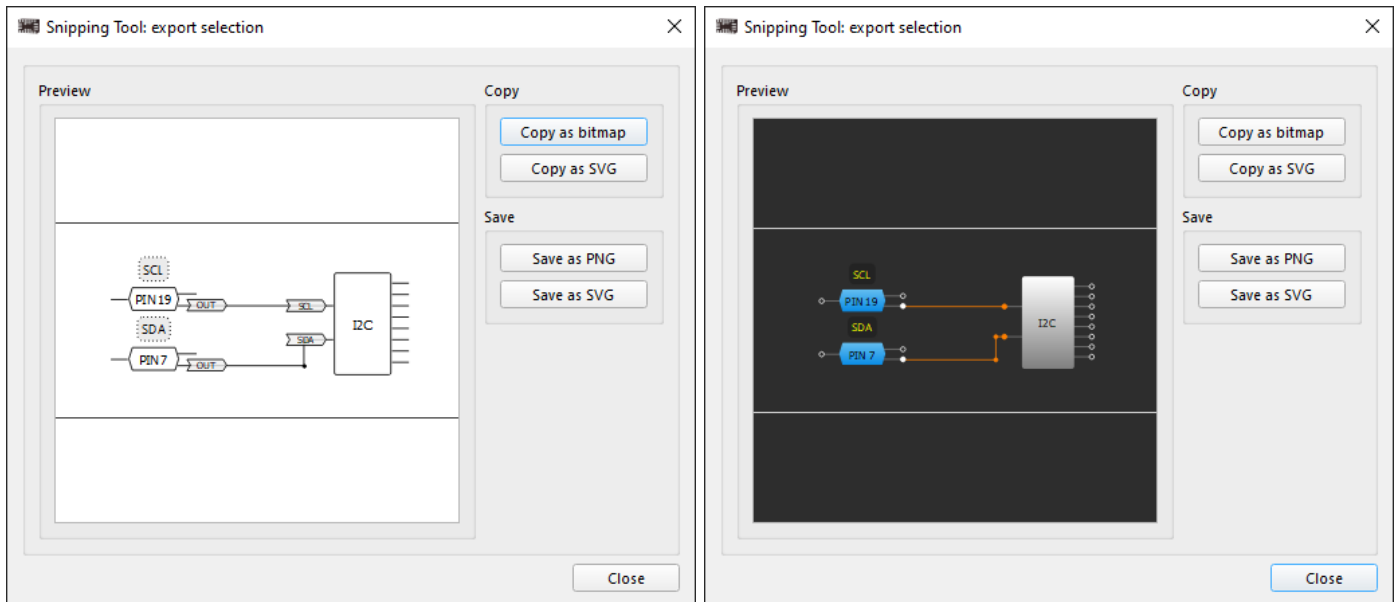

**Supported formats**

## 2.1.11 Rule checker

The *Rule Checker* tool scans a project for errors related to incorrect block connections or settings. To check the design, click *Rule Checker* on the toolbar (also, find the tool in the main menu → *View/Tools*).

The *Rule Checker* output window consists of three main columns:

- *Event* — shows the message type (Fail, Warning, Note)
- *Rule* — explains the essence of the issue
- *Note* — suggests the way to correct the error or provides more details about the issue

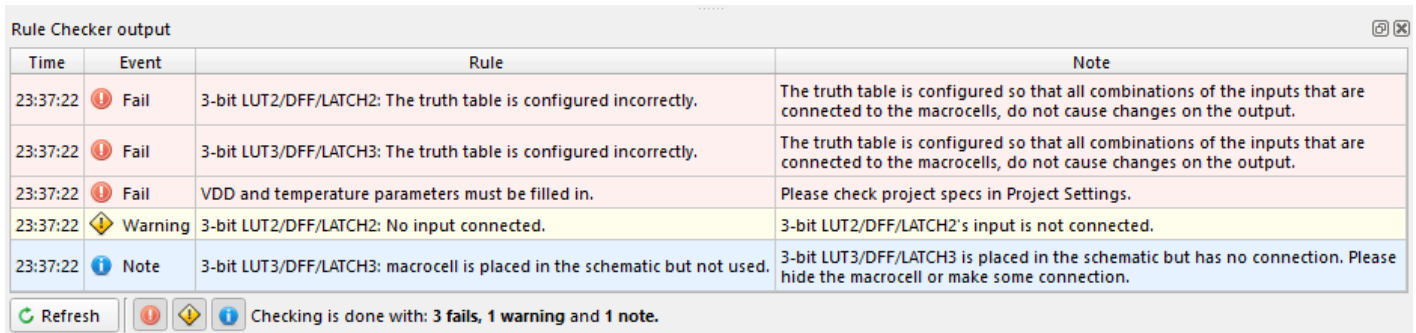

Time	Event	Rule	Note
23:37:22	Fail	3-bit LUT2/DFF/LATCH2: The truth table is configured incorrectly.	The truth table is configured so that all combinations of the inputs that are connected to the macrocells, do not cause changes on the output.
23:37:22	Fail	3-bit LUT3/DFF/LATCH3: The truth table is configured incorrectly.	The truth table is configured so that all combinations of the inputs that are connected to the macrocells, do not cause changes on the output.
23:37:22	Fail	VDD and temperature parameters must be filled in.	Please check project specs in Project Settings.
23:37:22	Warning	3-bit LUT2/DFF/LATCH2: No input connected.	3-bit LUT2/DFF/LATCH2's input is not connected.
23:37:22	Note	3-bit LUT3/DFF/LATCH3: macrocell is placed in the schematic but not used.	3-bit LUT3/DFF/LATCH3 is placed in the schematic but has no connection. Please hide the macrocell or make some connection.

Refresh [Fail] [Warning] [Note] Checking is done with: 3 fails, 1 warning and 1 note.

**Rule checker window**

You can use controls to sort the messages by their type. Click the *Refresh* button to see the latest events.

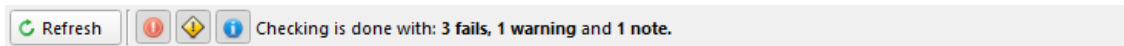

**Rule checker controls**

*Rule Checker* window shows three message types:



Fail

A critical error that may cause the project to fail is present in the design. In some cases, you can ignore this message type (the program may consider the design solution to be erroneous, but it is the correct solution for you).

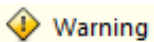

Warning

The project contains improper block(s) connections or settings. This message does not necessarily imply an error, but it notifies about a potential problem and urges checking the block(s) connections and settings.

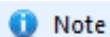

Note

This message type suggests minor improvements in the design. The suggestions are optional and can be ignored.



## 2.1.12 Comparison tool

The *Comparison tool* allows you to compare the NVM state of two projects. You can open the tool by clicking the *Comparison tool* widget on the toolbar or by reaching the main menu → *Tools* → *Comparison tool*.

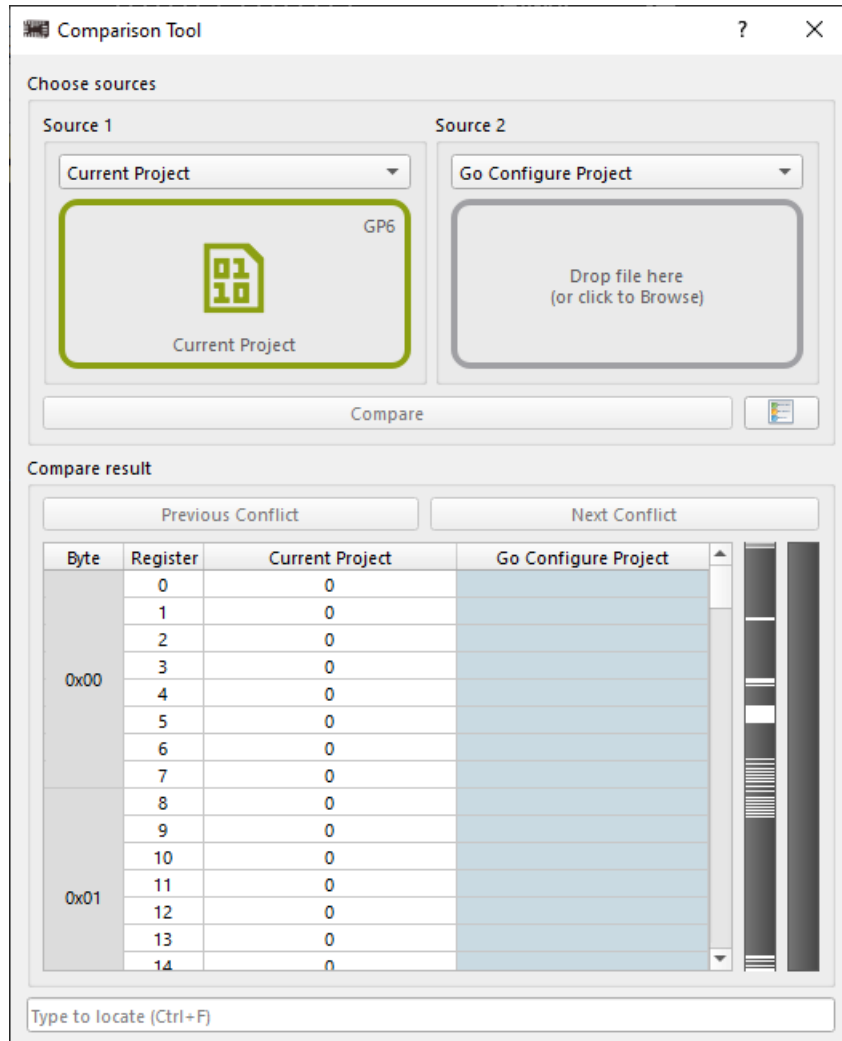

**Comparison tool**

The tool consists of two main parts: *Choose sources* and *Compare result*.

### Choose sources

Here you can select the sources for the NVM comparison. Select the source types from the dropdowns. Then click the designated area to choose the file or drag and drop it. The available sources are as follows:

- ▶ *Current Project* — current state of your design
- ▶ *Go Configure Project* — *Go Configure Software Hub* [project file](#) with the following extensions: .aap, .can, .gp3, .gp4, .gp5, .gp6, .hvp, and .ppak
- ▶ *Text File* — exported [NVM](#) file in .txt format

► *Chip Project* — configurations programmed on a chip

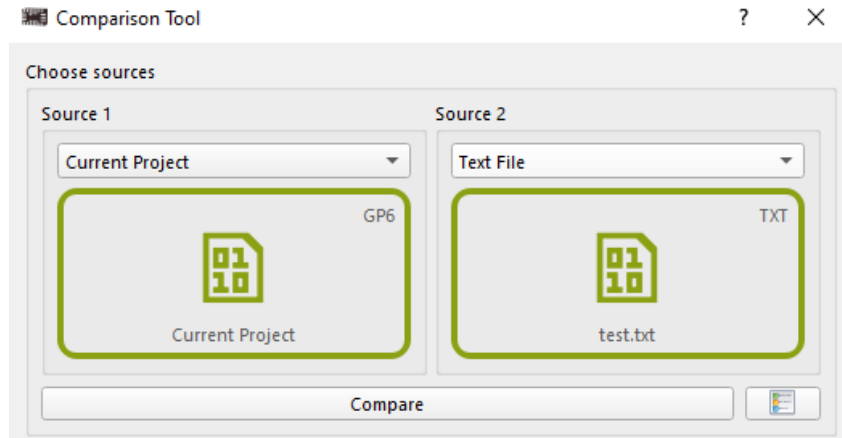

**Choose sources**

If you select *Chip Project* as a source, make sure you connect the supported platform with the inserted IC to your computer. The board info appears in the designated area. Click *Read* to add the programmed data to the tool. Clicking the *Blink* button triggers the blue LED on the connected platform. This feature is useful to check which board is currently detected by the *Go Configure Software Hub* instance. If multiple platforms are connected, select the desired one in the dropdown. Note that *Debug* tool should be disabled to use *Chip Project* as a source.

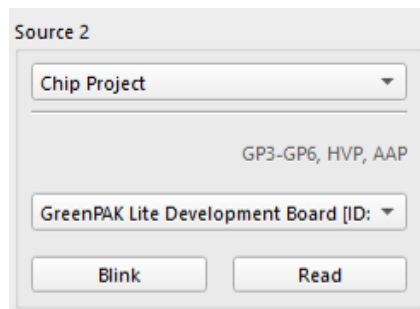

**Chip source**

The *Compare* button becomes active once two sources are selected (for *Chip Project*, after the source is selected, click *Read*). Upon clicking *Compare*, you can see a pop-up, where you can select the ranges to ignore while counting the conflicts.

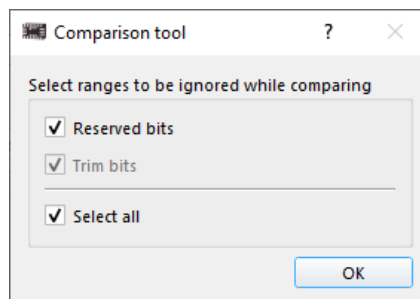

**Range selection**

Once the pop-up is closed, the *Comparing* window with the results appears.

## Compare results

After the sources are compared, you can see the table with the results. Navigate through the unmatched bits using *Previous Conflict* and *Next Conflict* buttons.

The screenshot shows the 'Comparison Tool' window. It has two source selection sections: 'Source 1' with a dropdown set to 'Current Project' and a 'GP6' icon, and 'Source 2' with a dropdown set to 'Go Configure Project' and a 'GP6' icon. Below these is a 'Compare' button. A 'Color scheme' dialog box is open, showing three options: 'Register set to 1' (white), 'Mismatches' (red), and 'Ignored mismatches' (yellow). Below the dialog is a table with columns for 'Byte', 'Register', and two source projects. The table shows data for bytes 0x00 and 0x01, with registers 0-14. A vertical navigation bar on the right side of the table shows colored bars corresponding to the data in the table. At the bottom of the window is a search bar with the text 'Type to locate (Ctrl+F)'.

Byte	Register	Current Project	Go Configure Project
0x00	0	0	0
	1	0	0
	2	0	0
	3	0	0
	4	0	0
	5	0	0
	6	0	0
	7	0	0
0x01	8	0	0
	9	0	0
	10	0	0
	11	0	0
	12	0	0
	13	0	0
	14	0	0

**Compare results and color scheme**

The table contains the information about a byte, register, and NVM of the selected sources. The vertical navigation bar indicates the location of 0 and 1 register values, along with conflicts and ignored bits. See the color explanations by clicking the *Color scheme* button.

You can also use the search field to find the particular byte or register.

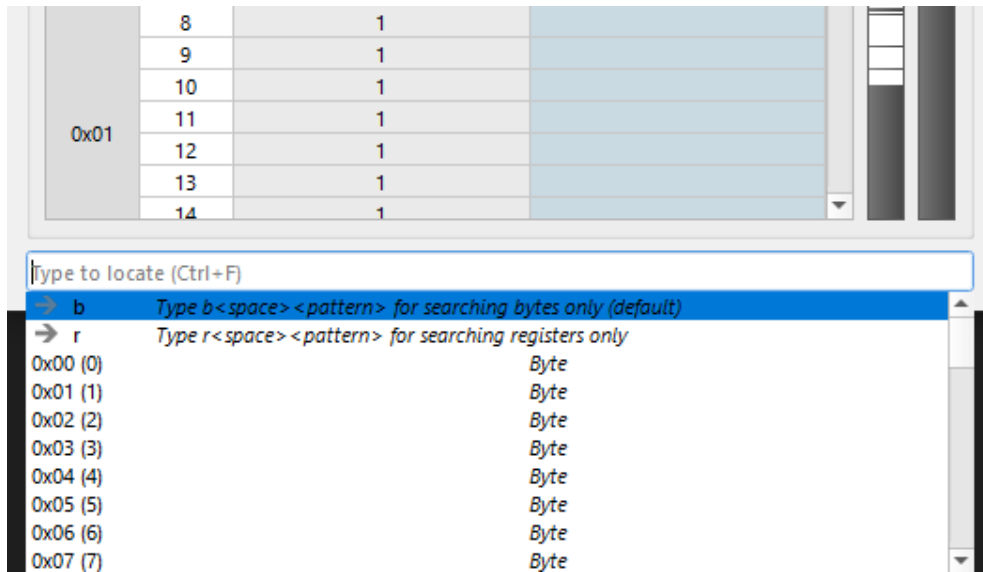

**Search field**

### 2.1.13 Power Dissipation Calculator

The tool helps to determine the amount of heat dissipation of the device, which is an important step in developing an effective thermal management solution. *Power Dissipation Calculator* is available only for the *HVPAK* Part Numbers and mainly applies to the HV OUT CTRL macrocell.

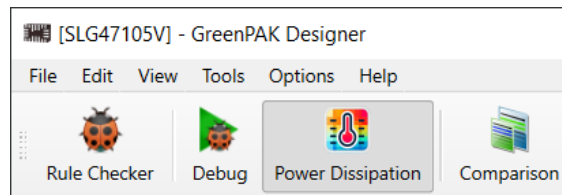

**Power Dissipation Calculator on the toolbar**

To launch the tool, click the *Power Dissipation* button on the toolbar or find it in the main menu, *Tools*.

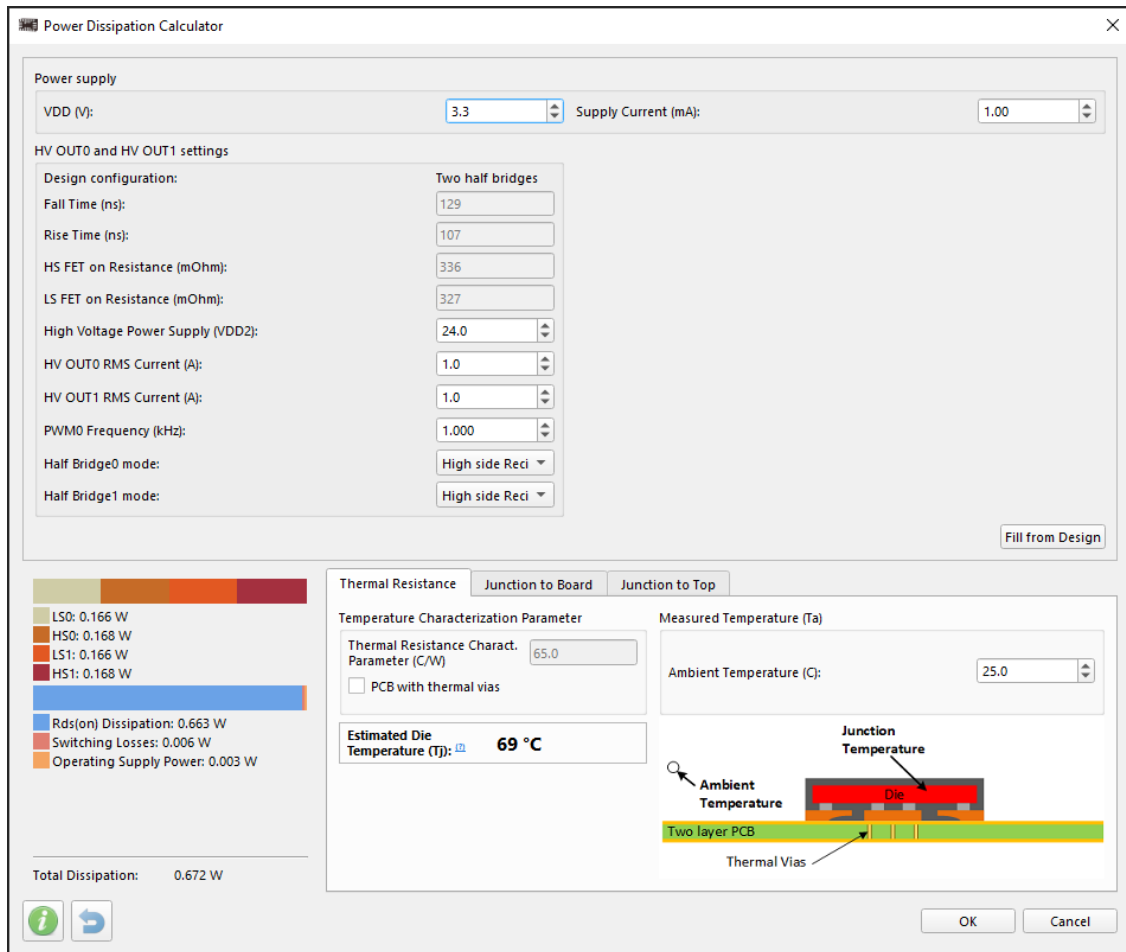

**Power Dissipation Calculator preview window**

The tool consists of four main parts:

- *Power supply* — voltage applied to VDD pin and estimated current consumption parameters

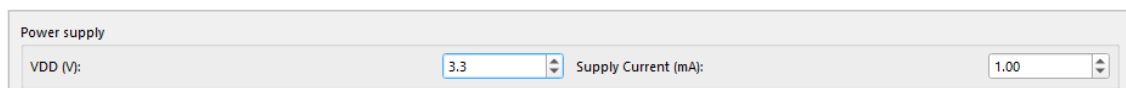

**Power supply**

- *HV OUT 0 and HV OUT 1 settings* — the main parameters of the power pins used in the design
  - *Design configuration* — reflects the *HV OUT mode* parameter selection, set on the HV OUT CTRL macrocell's *Properties* panel
  - *Fall Time/Rise Time/HS FET on resistance (mOhm)/LS FET on resistance (mOhm)* — configurations, which are automatically adjusted based on the conditions and configuration of the HV OUT CTRL component
  - *High Voltage Power Supply* — set the supply voltage (VDD2) for HV OUT CTRL

- *HV OUT RMS* — responsible for the output current and cannot exceed 1.5 A per HV OUT
- *PWM 0 Frequency (kHz)* — set the frequency at which HV OUT CTRL operates. You can set the frequency value using the PWM 0 macrocell. Additionally, you can automatically transfer the frequency value using the *Fill from Design* button in the lower right corner of the *HV OUT 0 and HV OUT 1 settings* section

**HV OUT 0 and HV OUT 1 settings**

**Note:** When the output pins connected to the HV OUT CTRL macrocell are in the *Hi-Z* state, *HV OUT 0 and HV OUT 1 settings* are displayed as locked. Change the HV Pin's *Output mode* on its *Properties* panel to unlock the settings.

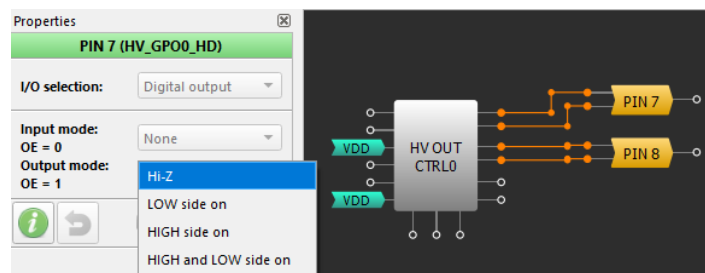

**HV OUT properties panel**

- *Power dissipation bar* — indication of the power dissipation for each transistor: *LSx* (*low side*) and *HSx* (*high side*). Below, you can see the total power dissipation, including open transistor resistance  $R_{ds(on)}$ , transistor switching losses, and the power dissipated by the chip even

when the output pins of HV OUT CTRL are in *Hi-Z*.

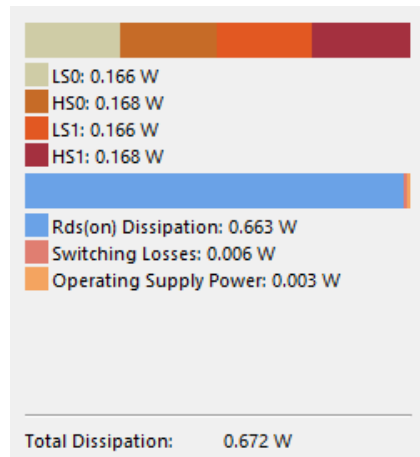

**Power dissipation bar**

➤ *Temperature Characterization* — provides three options for calculating the device *Die* temperature:

- *Thermal Resistance* — you need only the ambient temperature of the device for calculations. This method is the least accurate. If the platform you are using contains thermal vias, you can tick the respective checkbox to take it into account

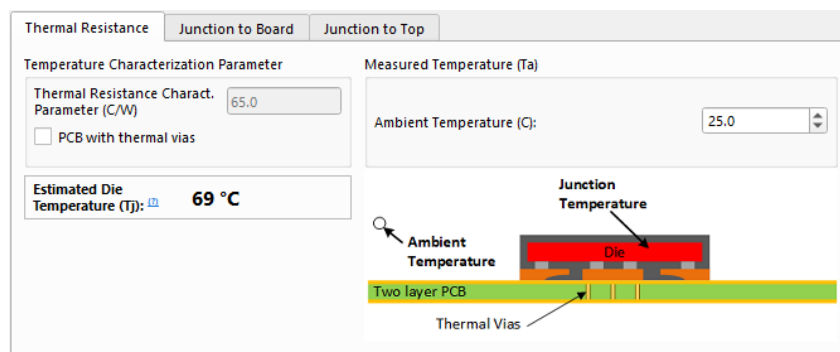

**Thermal resistance window**

- *Junction to Board* — the PCB temperature is used to calculate the *Die* temperature. It should be measured 1 mm from the device. This method has a higher accuracy compared to *Thermal Resistance*

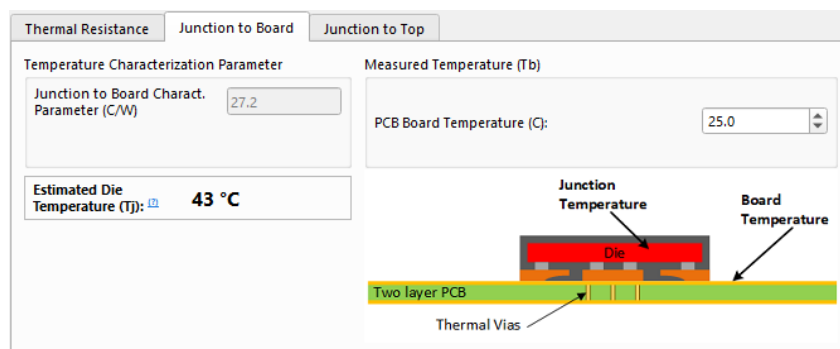

**Junction to Board window**

- *Junction to Top* — the temperature of the *Die* is determined based on the upper surface temperature of the chip. This method has the highest accuracy.

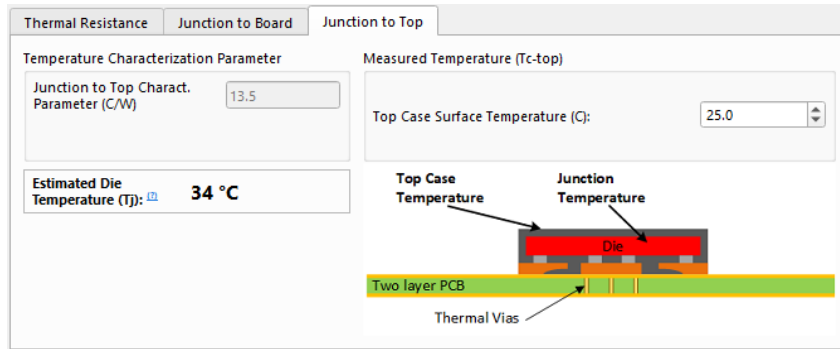

**Using Junction to Top window**

Keep the *Die* temperature below 150°C to ensure the chip operates correctly. An indication of overheating appears if the temperature exceeds the limit.

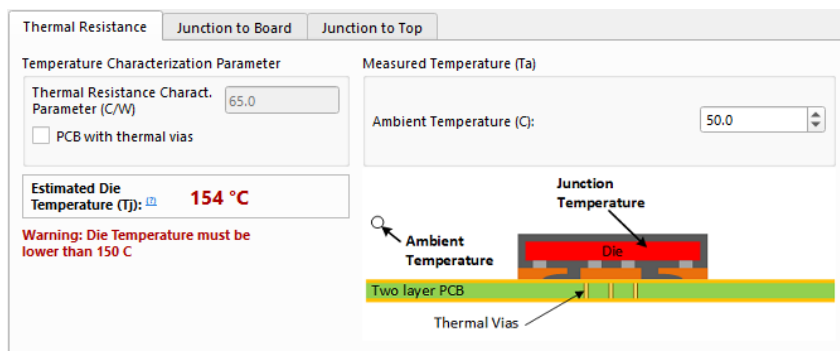

**Overheating warning**

## 2.1.14 Acceleration Profile Configurator

The *Acceleration Profile Configurator* tool is designed for linear motor speedup calculation based on specified frequency range. Launch the tool by clicking the *Acceleration Profile* button on the toolbar or find it in the main menu, *Tools*.

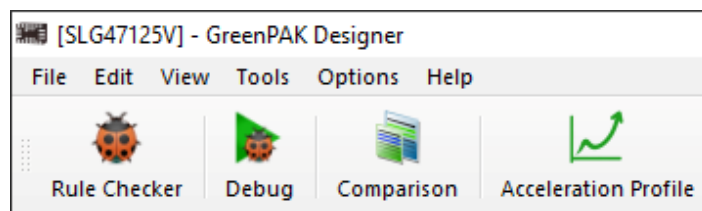

**Acceleration Profile on the toolbar**

Start with setting the parameters for your calculations:

- *Open loop duration* — time interval of motor operation (x-axis on the graph)



- ▶ *Initial period speed* and *Min closed loop speed* — motor rotation frequency range (y-axis on the graph). Both parameters can be configured in the tool directly or on the Commutation block *Properties* panel, since they are synchronized

Click the *Generate* button to perform the calculations on the basis of the provided data.

The results are represented in the following ways:

- ▶ *Waveform* — graphical visualization of motor operation. It provides the following information and possibilities:
  - x-axis (time interval set as *Open loop duration*) and y-axis (frequency range set as *Initial period speed* and *Min closed loop speed*)
  - current graph (based on latest added parameter values) and previous one (based on the previously set values)
  - *Closed loop speed* dotted line showing the upper frequency limit
  - tracker with labels
  - zoom by x-axis scale with *Ctrl + mouse wheel*

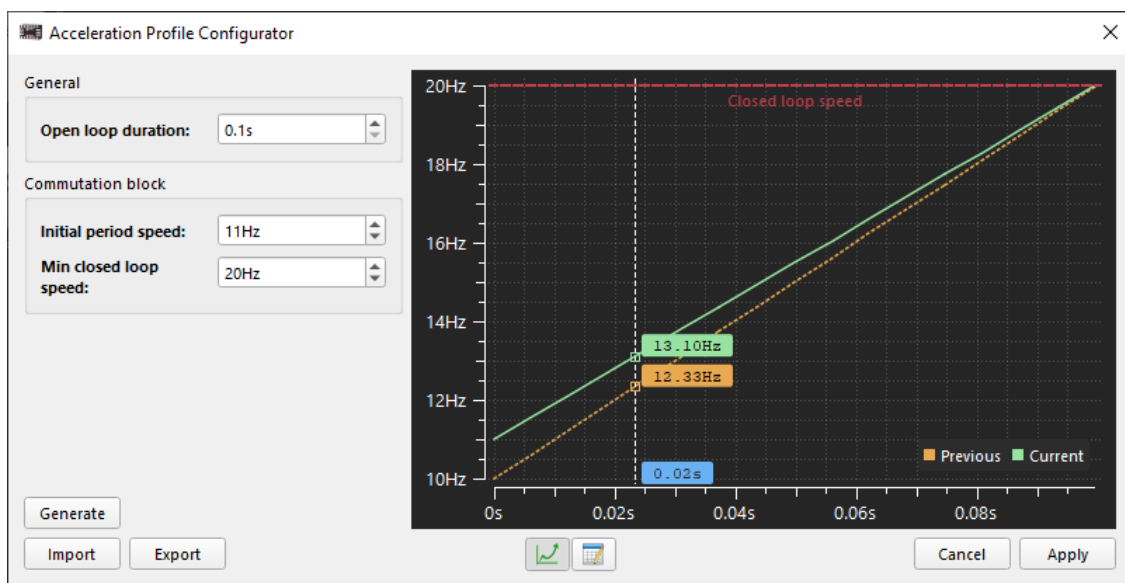

**Waveform**

- ▶ *Table* — the table contains 16 points. Each point consists of two values: *Divider Value* and *Counter (CNT) Value*. Each value consists of two parts: *MSB 8bit* and *shift 4bit* to reduce memory space. It is also possible to manually modify the *MSB* and *Shift* cells' data by double-clicking the cell

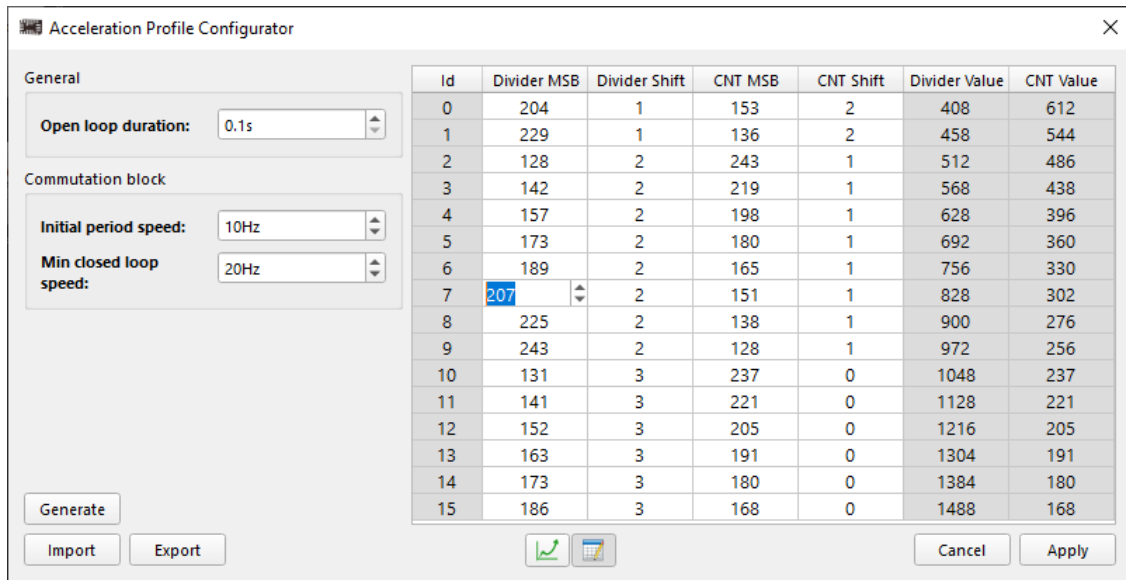

### Manual data editing

Import/Export the calculation results in .csv or .txt format using the respective bottom buttons.

**Note:** If you wish to write the table data to NVM click the *Apply* button.

### 2.1.15 Reg File Configurator

The tool interacts with Commutation block and PWM macrocells. For Commutation block, the tool provides the motor control waveform calculation according to the given amplitude and the Reg File size. For PWM, it performs the automatic fill-up of the Reg File for the specified waveform.

Start *Reg File Configurator* from the toolbar or find it in the main menu, *Tools*.

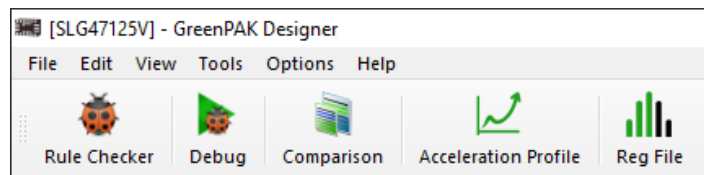

### Reg File Configurator on the toolbar

The set of parameters allows you to:

- Specify the used amount of bytes that can be read from Reg File by the selected macrocell
- Select the waveform type in which the generated data is represented (this option is available only while Commutation block macrocell is selected)
- Set the PWM resolution and the waveform amplitude

Click the *Generate* button to perform the calculations on the basis of the provided data (this option is available only while Commutation block macrocell is selected).

The tool provides two ways of data representation:

- ▶ *Waveform* — x-axis represents the amount of bytes that can be read by the selected block; y-axis is the waveform amplitude. The green part represents data stored in Ref File, while orange shows data for motor control generated automatically, based on Reg File data

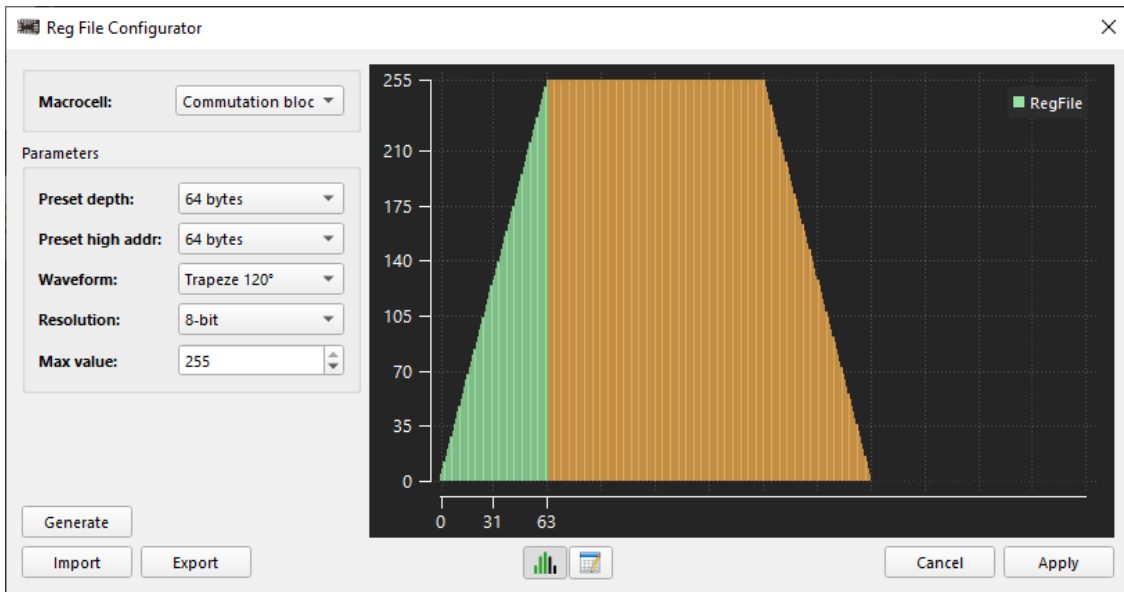

**Reg File Configurator window**

- ▶ *Table* — in addition to generated values, you can also manually modify the *Value* column cells upon double-clicking

The screenshot shows the 'Reg File Configurator' window with 'Macrocell' set to 'PWM0'. Under 'Parameters', 'Duty Cycle source' is 'RegFile 1st 8-byte' and 'Resolution' is '8-bit'. The main area is a table with the following data:

Byte #	Value	Duty Cycle	Vref
0	0	0.00 %	32 mV
1	0	0.00 %	32 mV
2	0	0.00 %	32 mV
3	0	0.00 %	32 mV
4	0	0.00 %	32 mV
5	0	0.00 %	32 mV
6	0	0.00 %	32 mV
7	0	0.00 %	32 mV
8	0	0.00 %	32 mV
9	0	0.00 %	32 mV
10	0	0.00 %	32 mV
11	0	0.00 %	32 mV
12	0	0.00 %	32 mV
13	0	0.00 %	32 mV
14	0	0.00 %	32 mV
15	0	0.00 %	32 mV
16	0	0.00 %	32 mV

The 'Value' cell for byte 6 is highlighted with a blue border and contains a small input field with the value '0'. At the bottom are 'Import', 'Export', 'Cancel', and 'Apply' buttons.

**Manual data editing**

Import/Export the calculation results in .csv or .txt format using the respective bottom buttons.

**Note:** If you wish to write the table data to NVM click the *Apply* button.

## 2.2 Debug tools

*Debug tools* are a set of instruments, that allow you to test and debug your design. To access *Debug tools*, click the *Debug* button on the toolbar. Since there are different hardware platforms available for a specific Part Number, select the platform most suitable for your project.

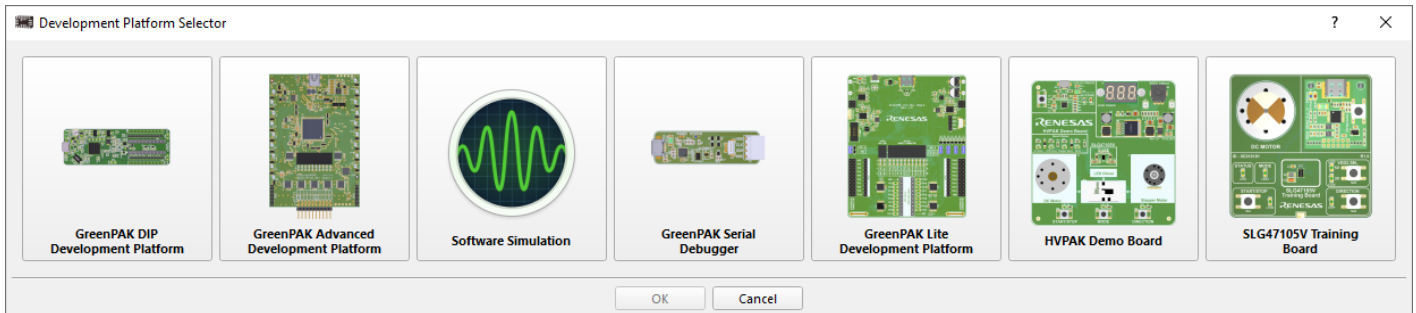

Platform selector window for SLG47105V

**Note:** You can only use the hardware in one application instance. If you wish to transfer control from one instance to another, disable *Debug tools* on the controlling instance.

After you select a platform, the software activates a toolbar and a panel with controls for main procedures, including emulation and chip programming.

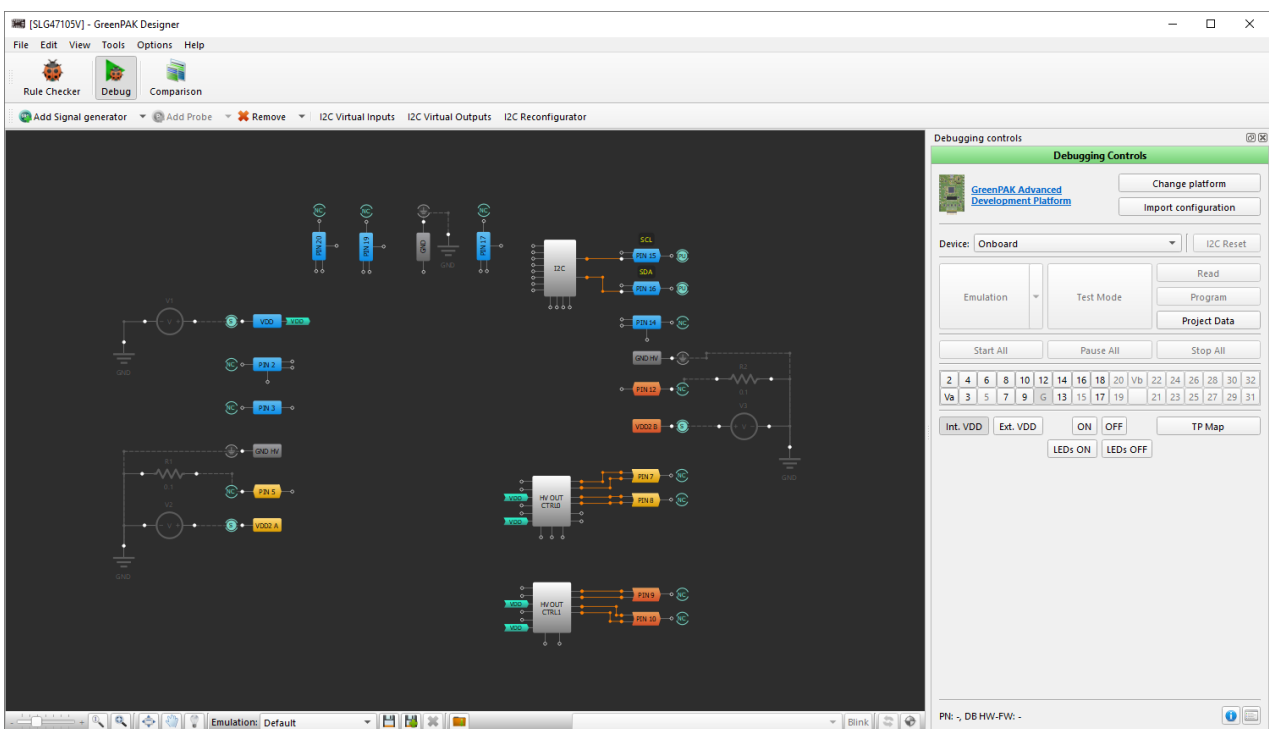

Software UI after Debug is enabled

## 2.2.1 Hardware sources

Go Configure Software Hub provides software tools to configure varied hardware sources that manage or generate input and test signals for a chip. Each signal source is connected to an external pin on a chip.



Below, you can find the complete list of all the hardware sources.

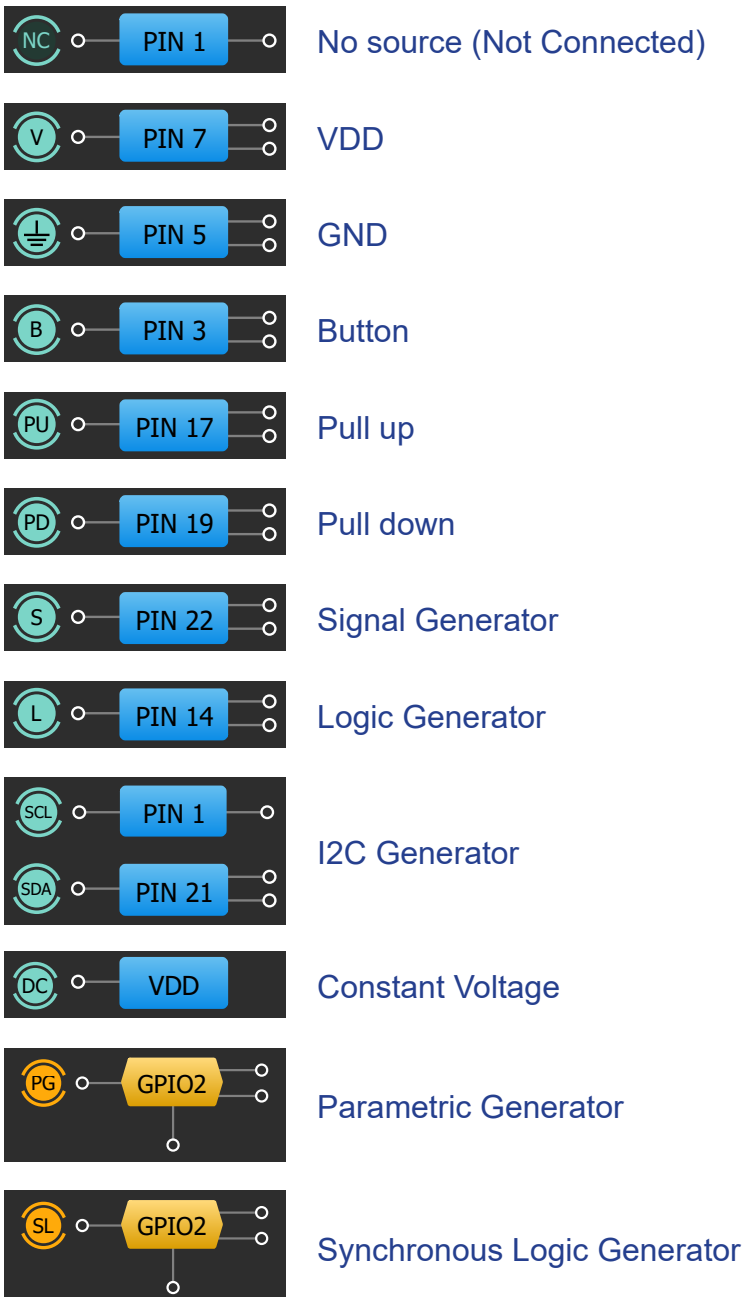

**Note:** The choice of hardware sources depends on the development platform features and chip restrictions.

You can switch the controls on/off via the context menu or from the toolbar via the *Add Signal Generator* or *Add VDD* button (the button view depends on the available sources).

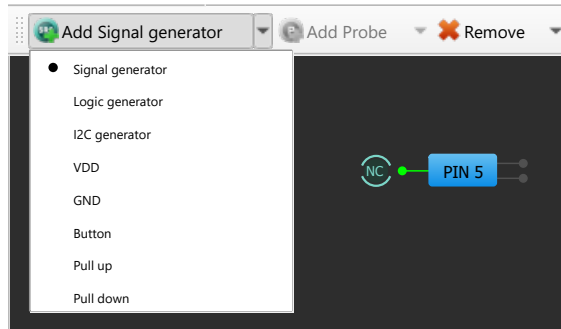

**Debug toolbar**

To remove the source click the *Remove* button or select *N/C* (Not Connected) in the context menu.

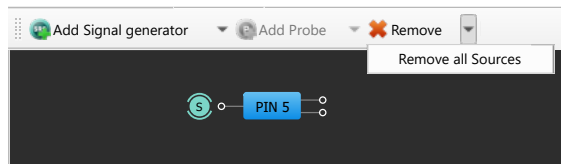

**Remove button on Debug toolbar**

Some of the chip pins may have additional controls, such as *LED indicators* or *Expansion Connectors (ECs)*, which are available even if a development platform is not connected yet. You can enable/disable the controls by hovering over the source and clicking the control you need.

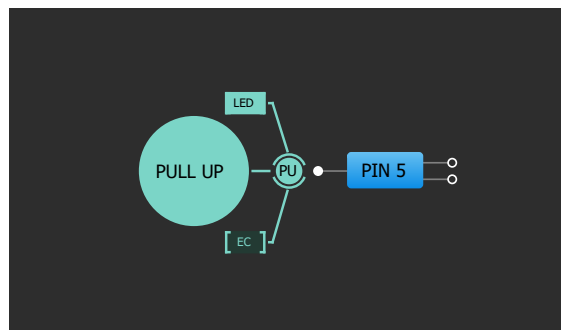

**Buffered LED**

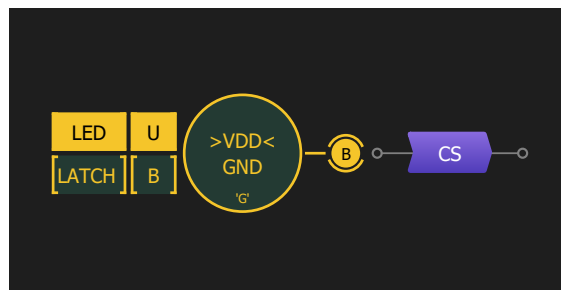

**PowerPAK buffered LED**

If you need to identify the chip pin connected to a specific test point on a board, use the *Test Point (TP) Map* tool. Note that the pins mapping to test points varies based on the chip type.

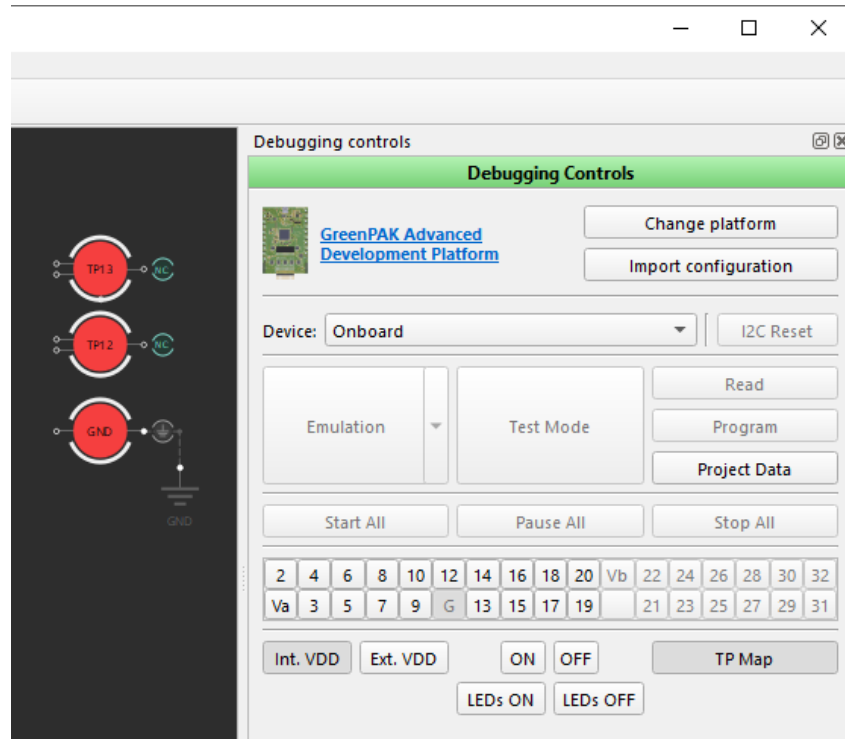

**TP map**

Hardware sources can be divided into two categories: *basic Hardware Sources* and *Generators*. *Generators* provide a comprehensive solution for creating analog or digital signals with configurable settings and are discussed in more detail in the section [2.2.2 Generators](#). Later in this chapter you can read about the *basic Hardware Sources*.

### Basic Hardware Sources

The available *basic Hardware Sources* are: *VDD*, *GND*, *Pull up*, *Pull down*, and *Button*. Unlike others, *Button* has more configuration possibilities (for the rest of the basic sources, all necessary information is already described above).

The *Button* hardware source allows quick switching between two predefined states: *Upper connection (U)* and *Bottom connection (B)*. These predefined states can be set to *VDD/GND*, *High-Z*, or *Pull Up/Down*. Hover the mouse cursor over the *Button* control to see its configuration.

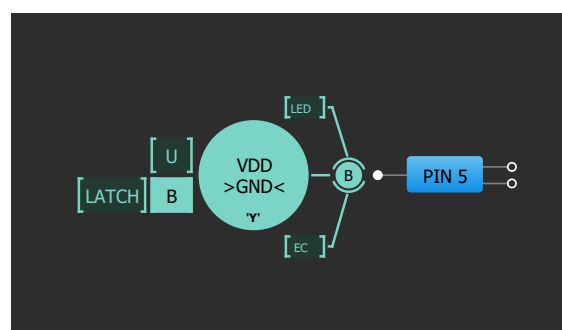

**Configurable Button**

The default connection can be set to either the *Upper connection (U)* or the *Bottom connection (B)*.

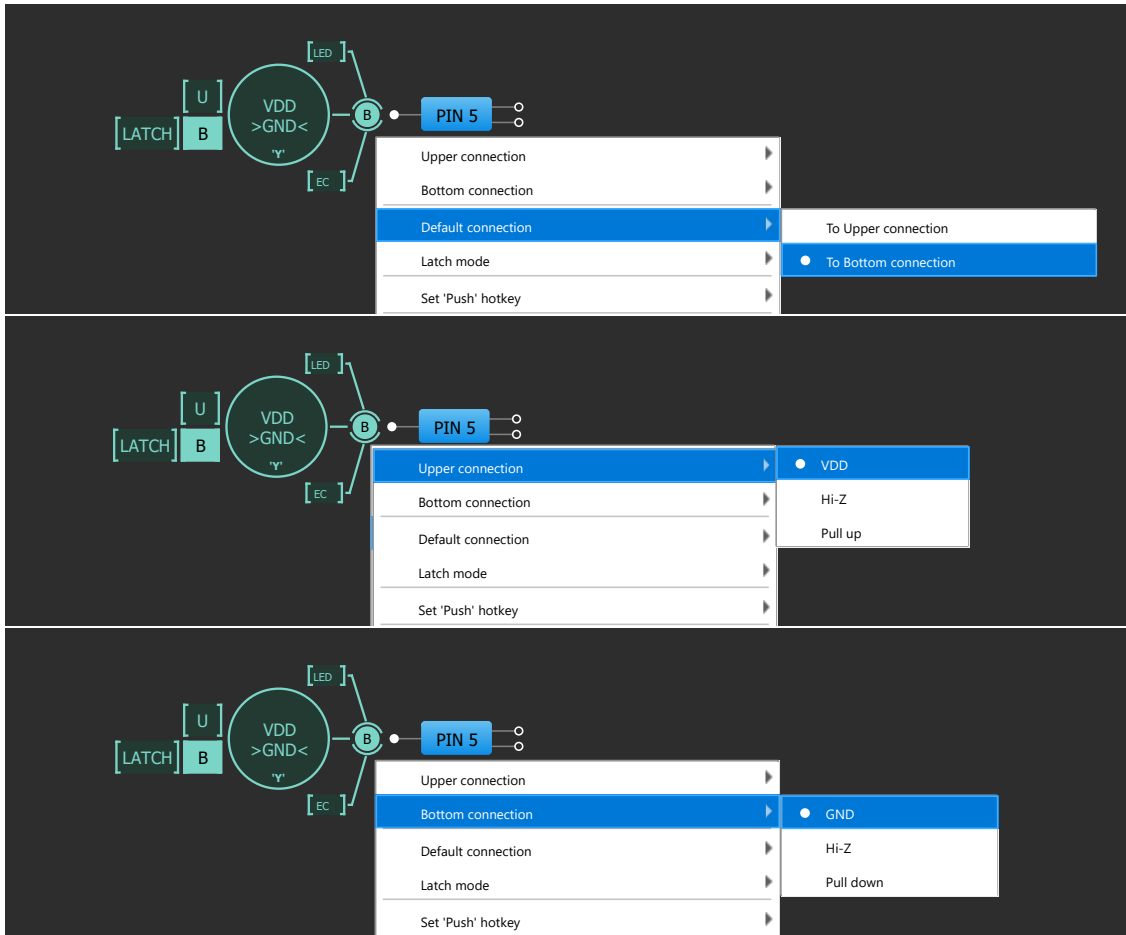

### Default Key Connection

*Latch* control has two modes: *Latched* and *Not latched*. You can configure these modes from the context menu or by clicking the *LATCH* button to change the value.

In *Latched* mode, the *Button* toggles its state on click and remains in the new state until the next click.

In *Not Latched* mode, the *Button* changes its state upon the left-click and returns to its previous state after the mouse button released.

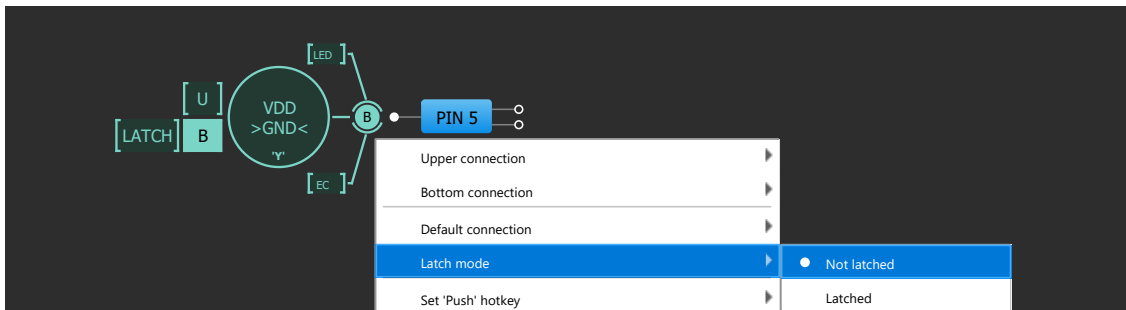

### Key Mode



You can assign a hotkey for the *Push* action. Pressing the hotkey is equal to a mouse click.

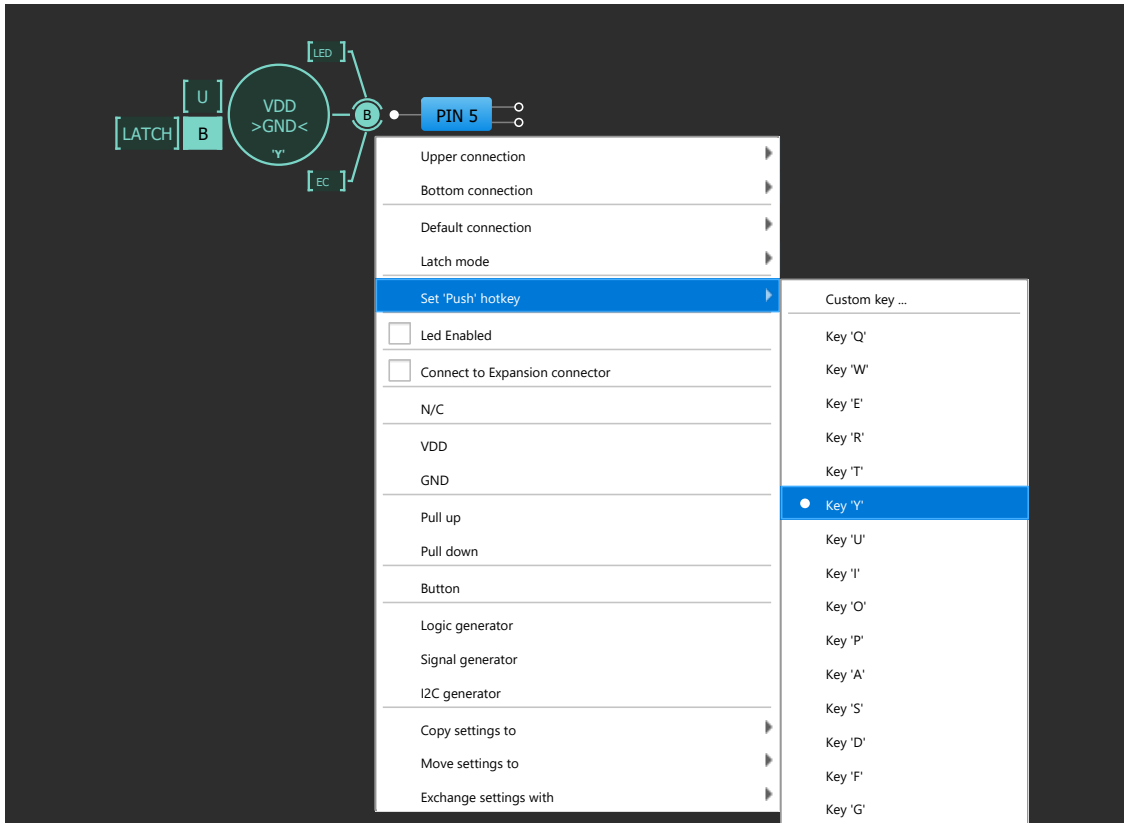

**Choosing hotkey**

You can assign the same hotkey to multiple *Buttons*, which allows changing the states of all the *Buttons* with the same hotkey at once.

## 2.2.2 Generators

A *Generator* is a hardware source type, that produces analog or digital electronic signals onto test points on a board. *Go Configure Software Hub* allows setting up the generators in an easy and convenient way with visual control of their settings and states. You can control the *Generator* using the sticker, which appears upon hovering over the respective icon. For more advanced configurations use the *Signal Wizard* tool. To find out more refer to section [2.2.3 Signal Wizard](#).

## Logic Generator

The *Logic Generator* generates logic pulses. A logic pulse is one of two voltages that correspond to two logic states (*low state* and *high state*, 0 and 1).

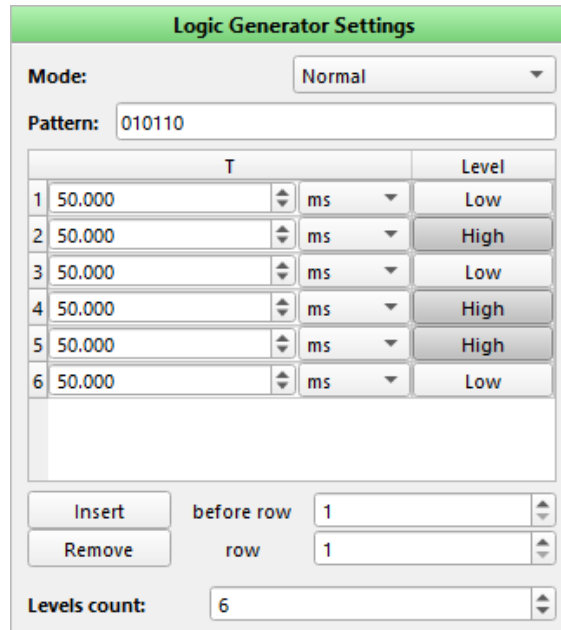

The Logic Generator Settings dialog box is shown with the following configuration:

- Mode: Normal
- Pattern: 010110
- Table with 6 rows and 3 columns: T, Level, and Level.

	T		Level
1	50.000	ms	Low
2	50.000	ms	High
3	50.000	ms	Low
4	50.000	ms	High
5	50.000	ms	High
6	50.000	ms	Low

Buttons: Insert, Remove, before row (1), row (1), Levels count (6).

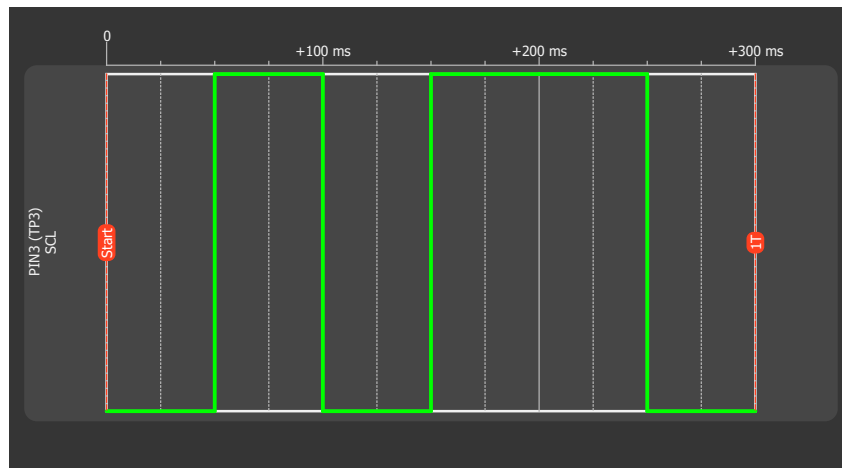

Logic Generator in Signal Wizard

You can export/import all *Logic Generator* settings. To do this, copy the *Pattern* field content and paste it to a text editor. The content will automatically convert to *XML* format text. You can use this feature to save your custom generators or load them from an external file.

## I2C Generator

The *I2C Generator*'s purpose is to create *I2C* (Inter-Integrated Circuit) communication patterns based on *Logic Generators*. There are two *Logic Generators* combined as *SDA* (Serial Data) and *SCL* (Serial Clock) lines. You can combine predefined *I2C* primitives to generate a required waveform

appropriately and choose the SCL frequency.

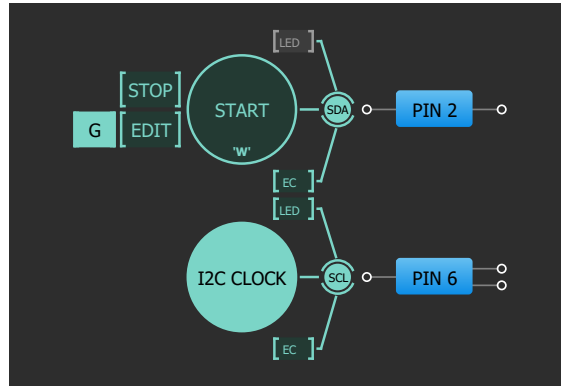

**I2C Generator**

SDA signal is a special case of *Logic Generator* used for sending data via I2C. The *Signal Wizard* editor shows the sequence of commands.

SCL signal is a particular *Logic Generator* that can be used for board configuration only. The SCL is configured by choosing a predefined frequency. The set of these frequencies depends on the development platform.

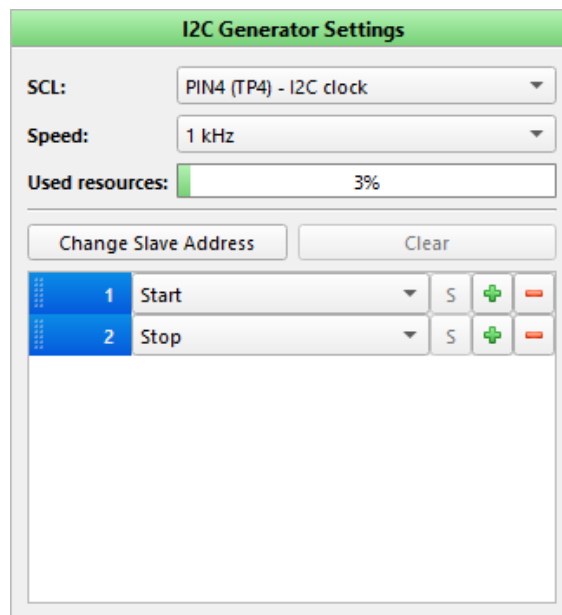

**I2C Generator command editor**

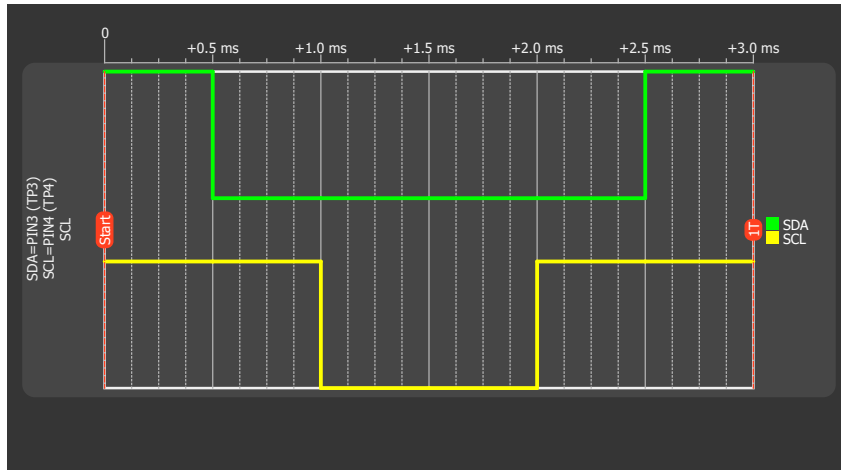

I2C Generator Signal Wizard

If you decide to change a type of a command, click an arrow and the drop-down menu will show the available commands.

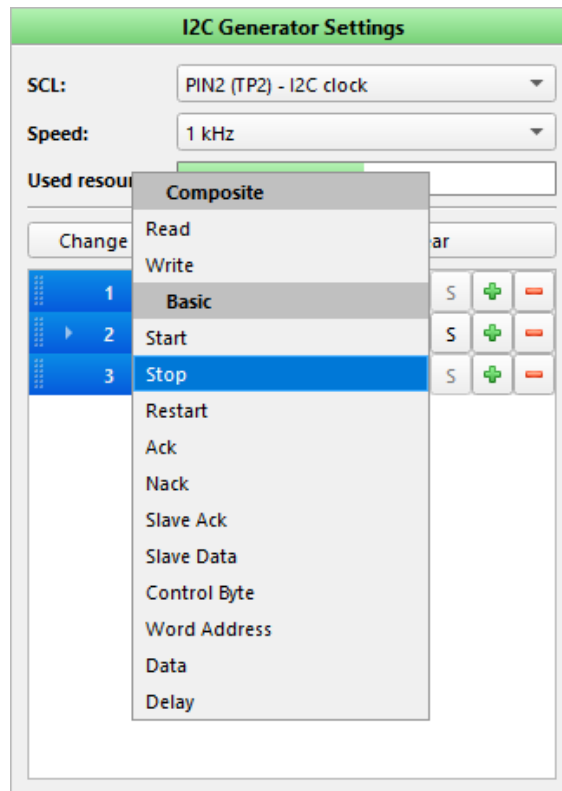

I2C command list

Composite commands *Read* and *Write* may be split into a sequence of basic commands (all commands are listed in the drop-down menu above).

## Signal (Analog) Generator

The *Signal Generator* produces the analog signal, and can be configured using one of the following pre-defined types: constant voltage, sine, trapeze, logic pattern, or custom signal.

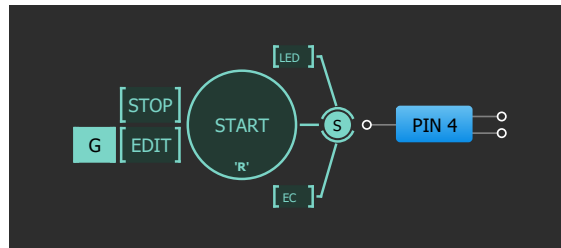

**Signal Generator**

Below, you can see the *Signal Wizard* view for different signal types.

► *Constant voltage waveform type*

The screenshot shows the 'Signal Generator Settings' dialog box. The 'Type' dropdown menu is set to 'Const. voltage'. The 'U:' field contains the value '3.299' and a unit dropdown menu is set to 'V'. Below these fields, the text 'Tolerance: ±7 mV' is displayed.

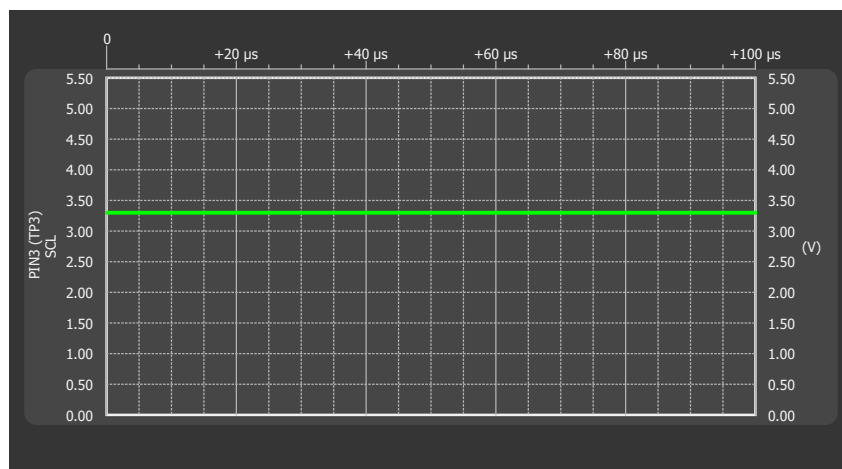

**Configuration options of Signal Generator, type Constant Voltage**

► Sine waveform type

Signal Generator Settings	
Type:	Sine
Phase:	0
Custom phase:	0.00 rad
Amplitude:	2.751 V
Zero offset:	2.751 V
Period:	1000.000 ms
Frequency:	1.00 Hz
Data:	Modify
Tolerance: $\pm 7$ mV	

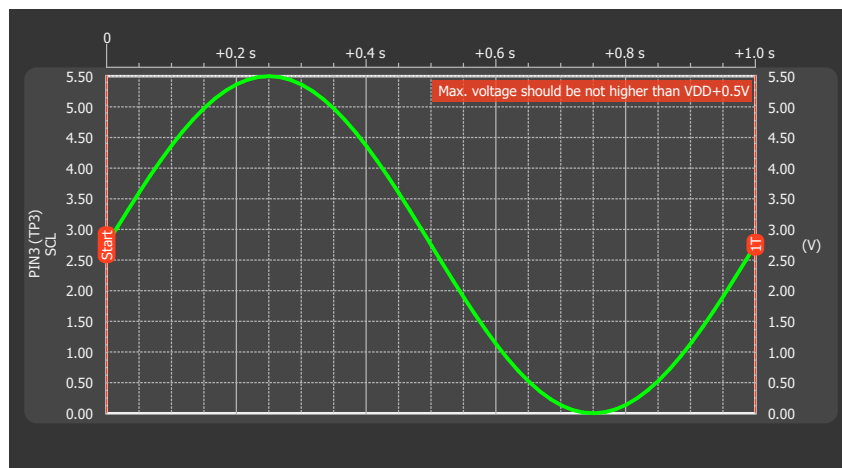

Configuration options of Signal Generator, type Sine

➤ Trapeze waveform type

Signal Generator Settings	
Type:	Trapeze (Triangle, Saw)
Mode:	Normal
Umax:	5.501 V
Umin:	0.000 V
T low:	250.000 ms
T rising:	250.000 ms
T high:	250.000 ms
T falling:	250.000 ms
Tolerance: $\pm 7$ mV	

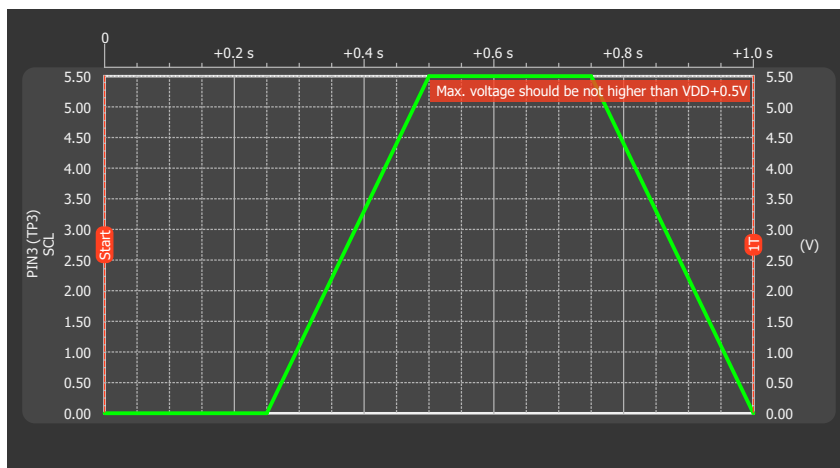

Configuration options of Signal Generator, type Trapezoid (Triangle, Sawtooth)

► Logic pattern waveform type

**Signal Generator Settings**

Type: Logic pattern

Mode: Normal

Levels adjustment: Standard

Umax: 5.501 V

Umin: 0.000 V

Pattern: 01101101

	T	U
1	50.000 ms	Umin
2	50.000 ms	Umax
3	50.000 ms	Umax
4	50.000 ms	Umin
5	50.000 ms	Umax
6	50.000 ms	Umax
7	50.000 ms	Umin
8	50.000 ms	Umax

Insert before row 1

Remove row 1

Levels count: 8

Data: Modify

Tolerance: ±7 mV

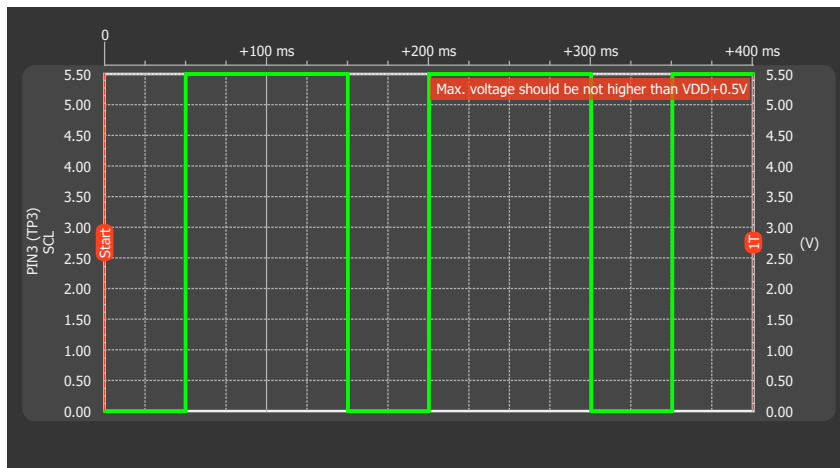

Configuration options for Signal Generator, type Logic pattern



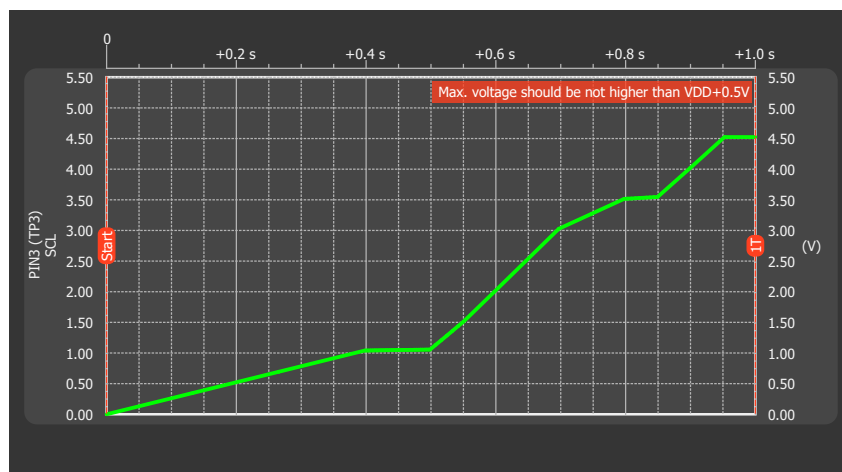
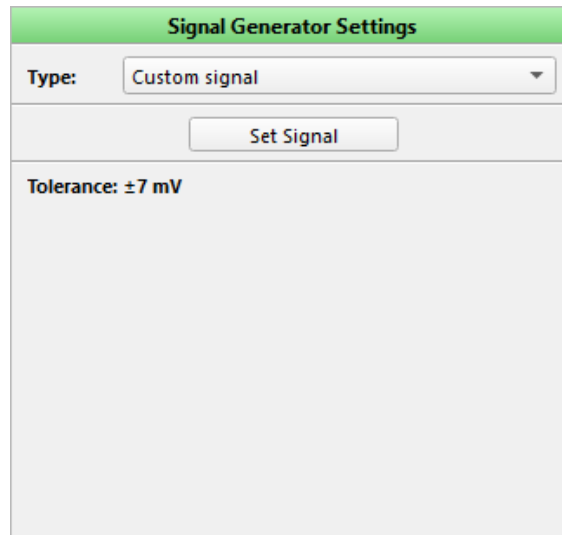

**Configuration options of Custom Signal (arbitrary waveform) Generator**

The custom signal can be configured in a separate window. Find out more in section [2.2.4 Custom Signal Wizard](#).

### VDD/VDD2 Power Signal Generator

Some Part Numbers have an additional power supply (*VDD2*); if present, it allows to interface two independent voltage domains within the same design. You can configure the pins dedicated to each power supply as inputs, outputs, or both (controlled dynamically by the internal logic) to *VDD* and *VDD2* voltage domains. Using the available macrocell, you can implement mixed-signal functions bridging both domains or pass through level translation in *HIGH* to *LOW* and *LOW* to *HIGH* directions.

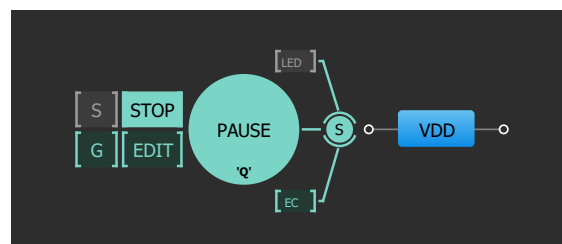

**VDD/VDD2 Power Signal Generator**

If the *Sync Power Rails [S]* mode is enabled in *Signal Wizard*, VDD and VDD2 share the same power settings. The option is available only for VDD / VDD2 power generators.

## Synchronous Logic Generator

The *Synchronous Logic Generator* is used for generating the logic pulses and waveforms on GPIO pins. It is a 64-channel digital pattern Generator, provided only by *ForgeFPGA™ Advanced Development Board*.

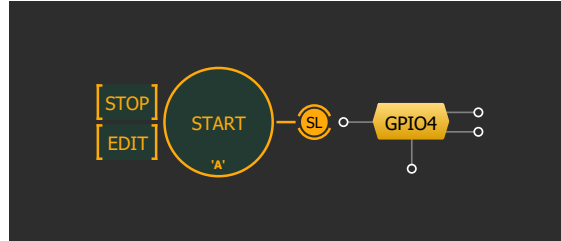

**Synchronous Logic Generator**

You can enhance the efficiency of this generator by using the *Signal Wizard*, which offers two types of resources: *used bandwidth* and *used points*. *Used bandwidth* refers to buffer occupancy and depends on *points density*.

The top complex graph displays two metrics: a green line for *points density* (points per second) and a yellow line for *used bandwidth*. The peak value of the *used bandwidth* line correlates with the used bandwidth value in *Parametric Generator Settings*. This graph precisely summarizes resource usage in all waveforms displayed below over one period.

You can adjust your screen view and toggle the graph visibility using the button in the bottom right corner of the window.

While the graph at the top of the window represents all waveforms collectively, the indicators to the right of the generators display information for each channel individually. Each channel has two different indicators:

- *Points Usage Indicator* — shows the number of points a channel is using.
- *Resource Percentage Indicator* — displays the used bandwidth for each channel.

Both indicators are color-coded and will change colors depending on their values or percentages.

The legends are available for each indicator to check the value range.

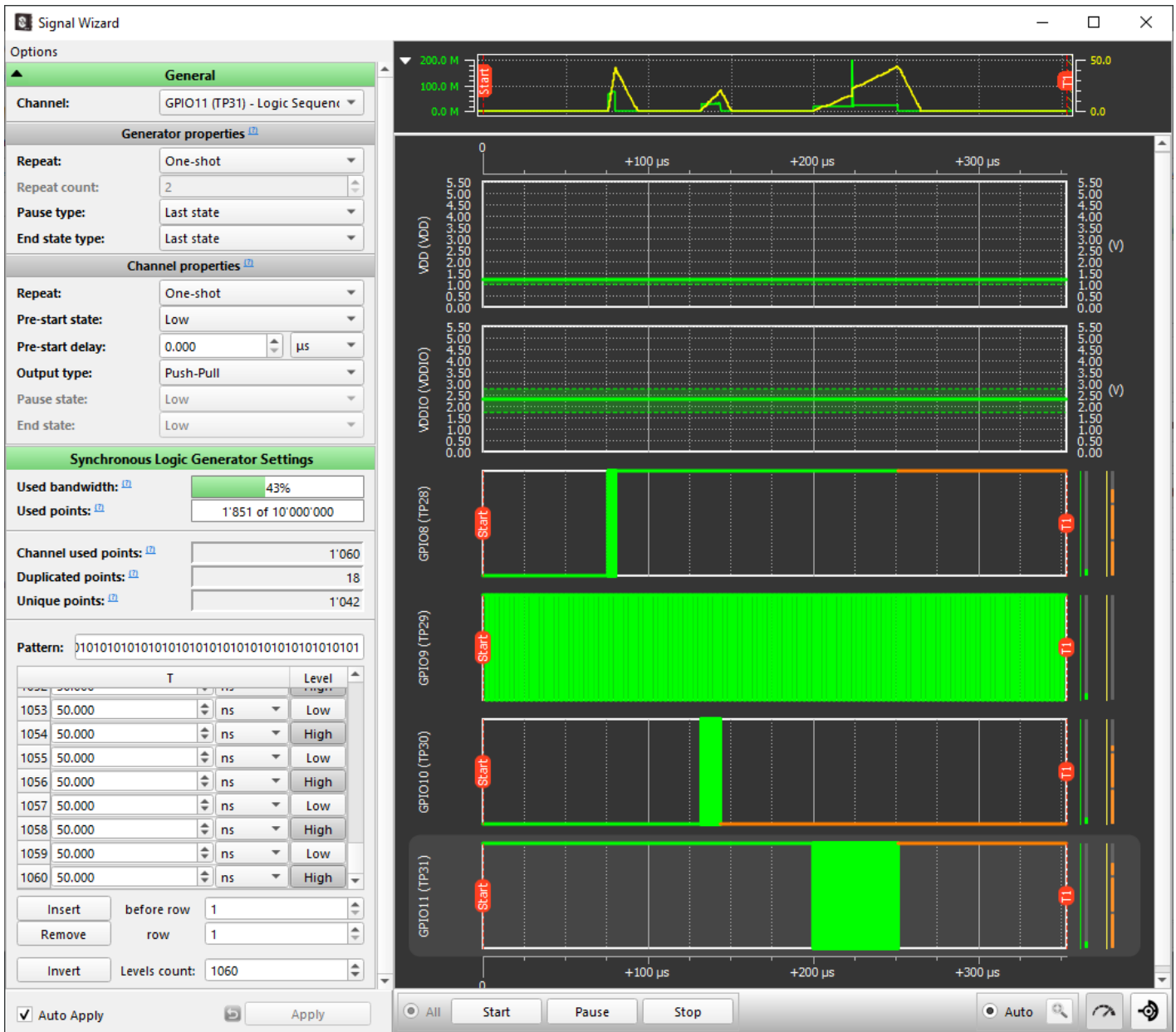

**Synchronous Logic Generator window**

The *Used points* metric displays the cumulative number of points used by patterns across all channels. A point shows any change in the level across any of the 64 channels, including pre-start delay and endstate. However, if two or more channels change levels simultaneously, it will be counted as one generator point.

The Wizard also helps to understand each channel individually.

- *Channel used points* combine the duplicated points and unique points in a selected channel
- *Duplicated points* show the total duplicated points currently used by the generator
- *Unique points* represent the total unique points currently used by the generator

**Synchronous Logic Generator Settings**

Used bandwidth: [?](#)

Used points: [?](#)

---

Channel used points: [?](#)

Duplicated points: [?](#)

Unique points: [?](#)

---

Pattern:

T			Level
1	<input type="text" value="50.000"/>	<input type="text" value="µs"/>	Low
2	<input type="text" value="50.000"/>	<input type="text" value="µs"/>	High
3	<input type="text" value="50.000"/>	<input type="text" value="µs"/>	Low
4	<input type="text" value="50.000"/>	<input type="text" value="µs"/>	High
5	<input type="text" value="50.000"/>	<input type="text" value="µs"/>	High
6	<input type="text" value="50.000"/>	<input type="text" value="µs"/>	Low

before row   
 row   
 Levels count:

**Synchronous Logic Generator properties**

### Parametric Generator

The *Parametric Generator* generates logic pulses that follow different protocol sequences. This type is also available for *ForgeFPGA™ Advanced Development Board*.

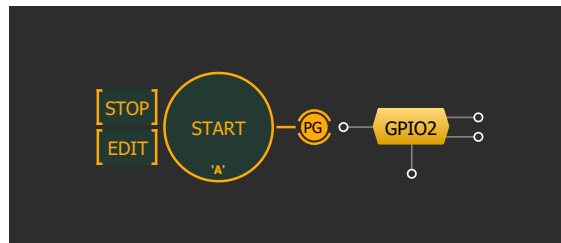

**Parametric Generator**

In *Signal Wizard*, a special editor shows the sequence of commands.

Actions available in the command editor:

- Add or remove commands by clicking + and -
- Change command parameters
- Change the order of commands by dragging the command to another position

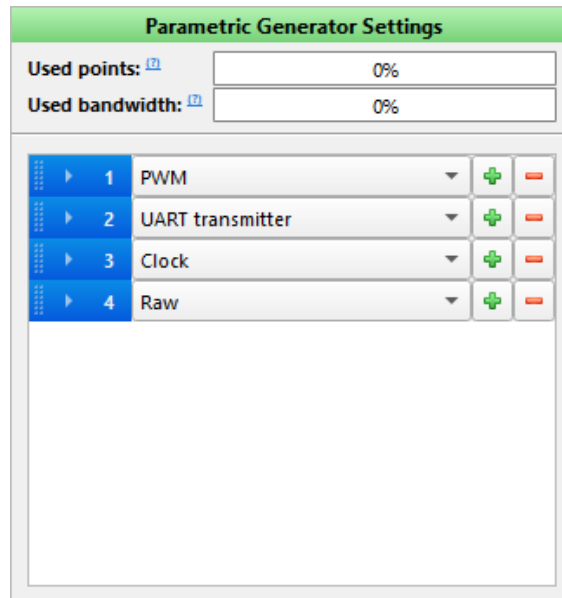

**Parametric Generator command editor**

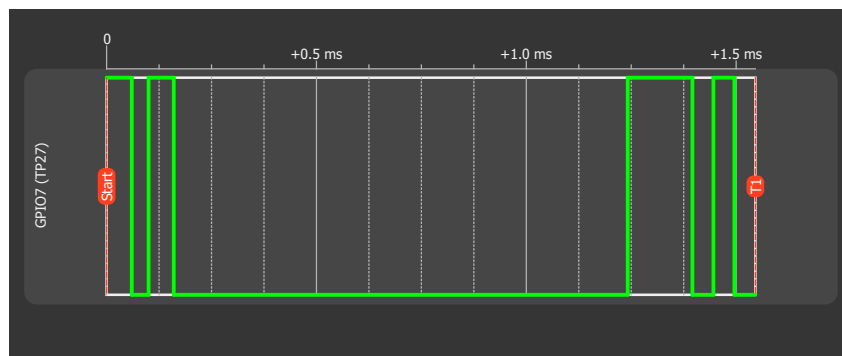

**Signal Wizard for the Parametric Generator**

The list of available commands:

- ▶ *PWM* (Pulse Width Modulation) — the *PWM command editor* has three input fields:
  - *Period* — a united duration of high and low states per repeat
  - *Duty cycle* — the percentage of the total duration in the high state
  - *Repeats* — pattern repeat count

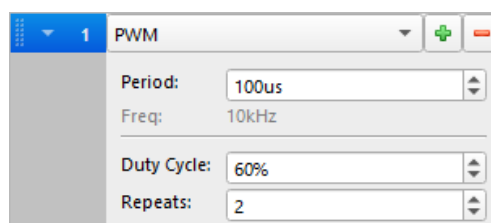

**PWM command editor**

- ▶ *Clock* — the command generates a signal oscillating between a high and a low state. The

editor has two input fields:

- *Period* — the united duration of high and low states per repeat
- *Repeats* — pattern repeat count

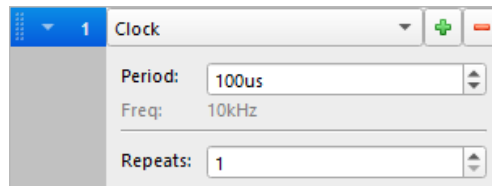

**Clock command editor**

➤ *UART Transmitter* — generates signal according to the *UART* standard:

- *Baud rate* — signal's frequency
- *Data frame* — number of bits allocated for user input
- *Data* — user input in hex format. In case the data frame is lower than the bits required to represent data, more significant bits are ignored
- *Parity bit* — create parity bit for error detection
- *Stop bit size* — duration of the stop bit
- *Bit order* — serial data transfer format

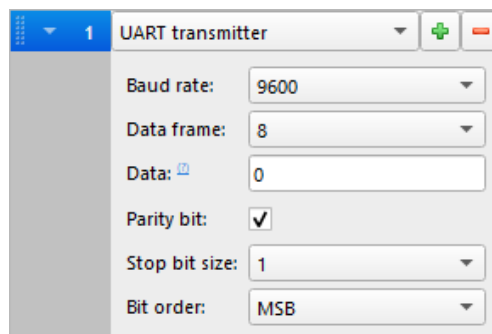

**UART transmitter command editor**

➤ *Raw* — this pattern works as a typical *Logic Generator*

## 2.2.3 Signal Wizard

To start configuring a *Generator*, double-click its icon next to the pin or find *Edit* in its context menu.

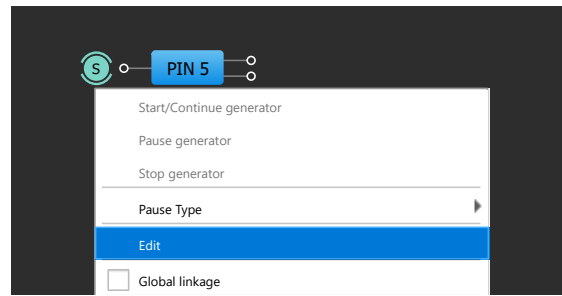

Opening Signal Wizard

The *Signal Wizard* window contains a *Generator* settings panel and the plot (waveform preview). The window is common for all *Generators*, though different set of settings may be activated, depending on the selected hardware source.

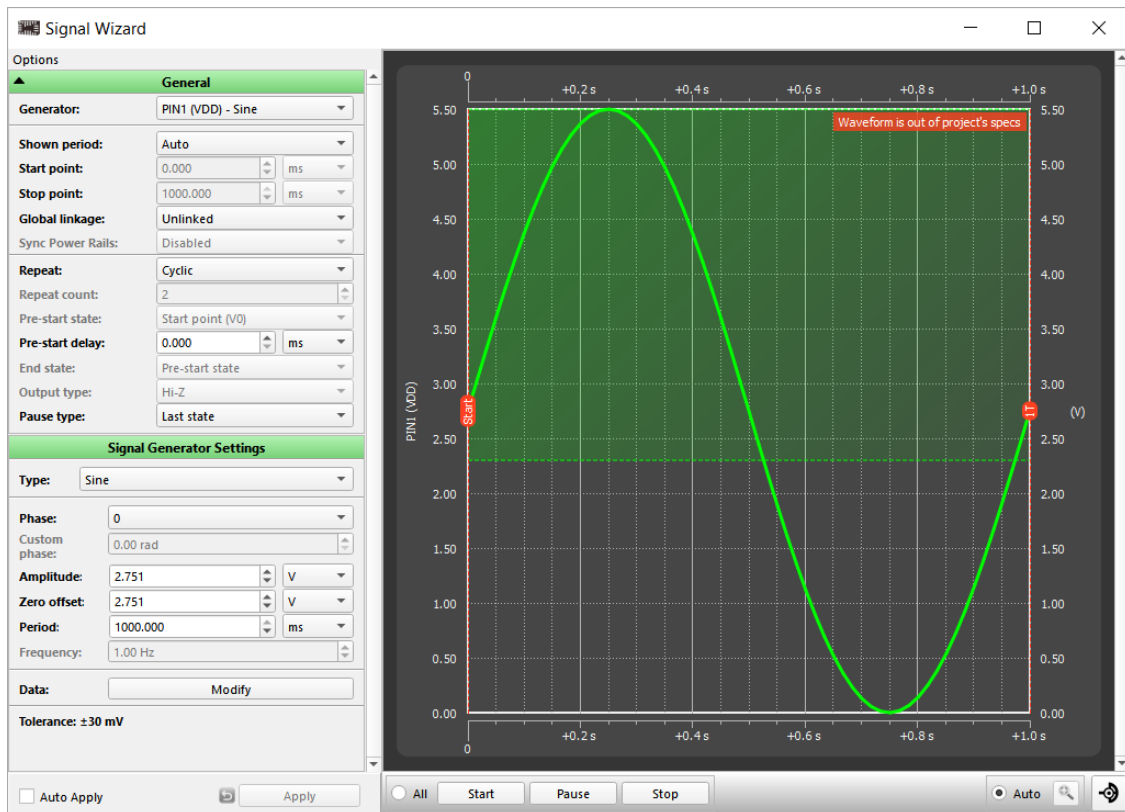

Signal Wizard window

*General* settings category mostly provides signal configurations related to time, period, and state. Below you can see the settings which may require more detailed description.

- *Global Linkage* — when enabled, provides possibility to control *Generator* using *Start/Stop/Pause* buttons on the *Debugging Controls* panel
- *Sync Power Rails* — enable for VDD and VDD2 to share the same power settings. The option is available only for *VDD / VDD2 Power Generators*

The lower settings part is generator-specific. Read more in section [2.2.2 Generators](#).

## Scaling controls

Scaling controls are located at the bottom right corner of the *Signal Wizard*. The controls let you adjust the number of periods shown in the waveform preview.

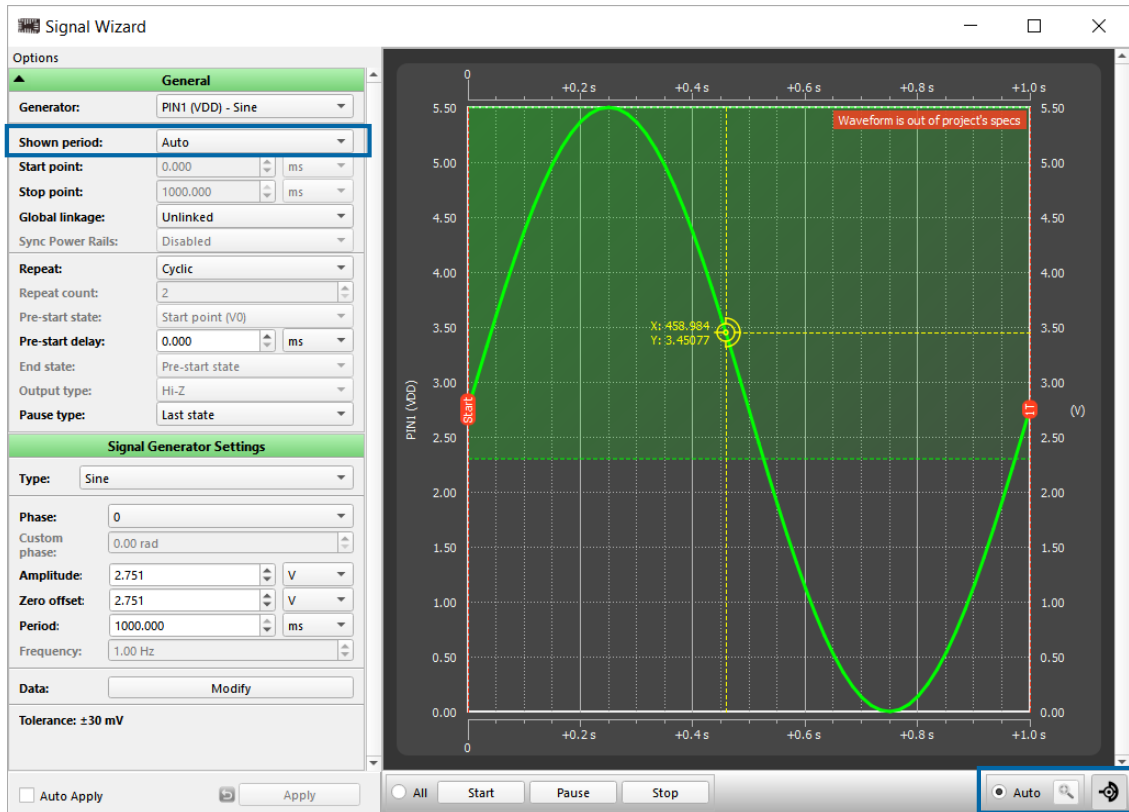

**Scaling in Signal Wizard**

You can use the *Cursor* button to turn the mouse coordinates on/off in the timing diagrams.

- *Auto* — scale all generators to fit the biggest period among them. Only generators with *Shown period* set to *Auto* are affected.
- *Custom* — waveforms can be re-scaled manually. To do that, ensure that the *Auto* mode is OFF and then scale by **Ctrl + mouse wheel**.



## 2.2.4 Custom Signal Wizard

*Custom Signal Wizard* allows creating, importing, and editing the signal waveforms (applicable only for *Signal (Analog) Generators*). The signal can be created by manually adding points or importing a custom list of points from an external source.

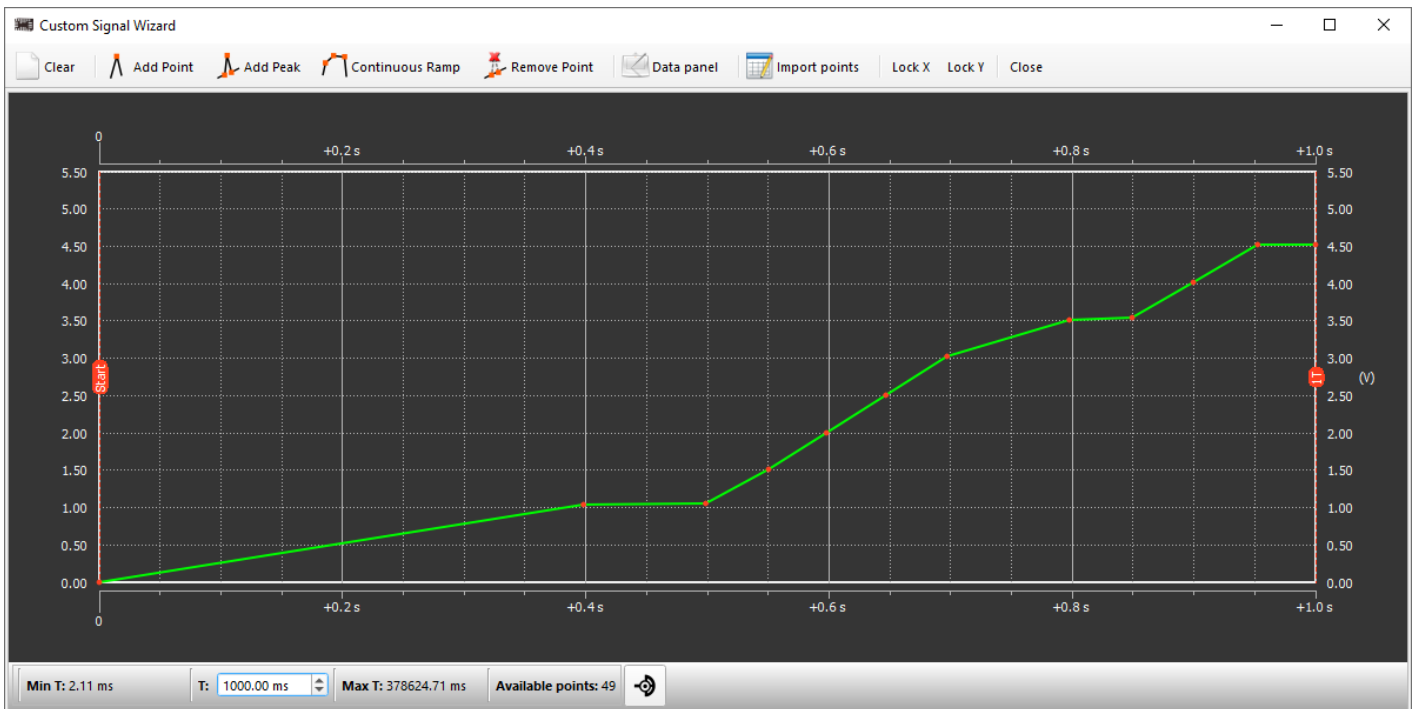

**Drawing Signal (Arbitrary waveform)**

Use the controls on the toolbar to manipulate the waveform.

- *Add Point/Peak/Continuous Ramp* — use the buttons to start creating the signal waveform
- *Remove Point* — click the button to remove a selected point (or use a right-click)
- *Data Panel* — show or hide the data table. You can remove/change values for a selected point or add a point in between

- *Import Points* — click the widget to open the *Import* window and insert the points' coordinates

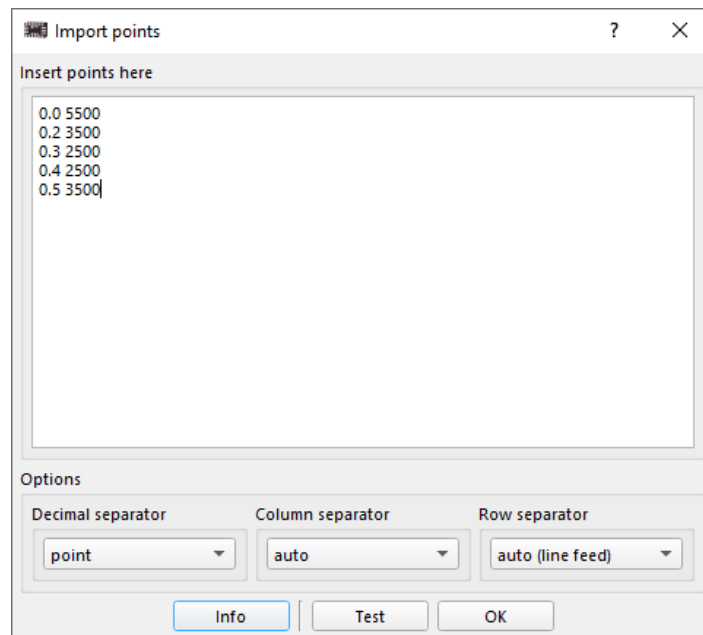

**Import Points**

See the coordinates formatting options:



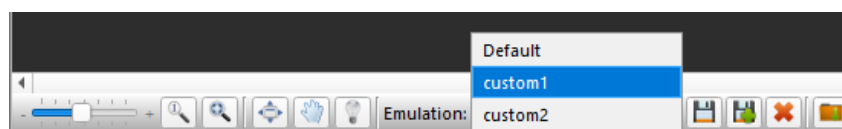

- *Decimal separator*: point/comma
- *Column separator*: auto/tab/other
- *Row separator*: auto(line feed)/tab/other

## 2.2.5 Hardware configurations

You can create configuration state snapshots to restore a previous configuration when needed. The snapshots include your hardware sources' configuration and are saved and loaded with your project file. This option is available for both *Generators* and *basic Hardware Sources*.



**Saved configurations**

-  Save the current configuration state
-  Save a new configuration state
-  Delete the selected configuration
-  Import new configuration

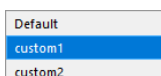

The list of saved configurations

## 2.2.6 Debugging Controls

To access the required development platform through the software, click [Debug](#) and select the board from the list of supported platforms.

The *Debugging Controls* panel appears. It contains the UI controls for chip communication and programming, brief information about the connected devices, and other features described below.

Later in this section, you can read about all *Debugging Controls* panel UI elements you may encounter while working with different platforms. In chapter [3 Devices](#), you can see the supported development platforms description and the *Debugging Controls* panel for each board.

The table listing *Debugging Controls* elements availability for all boards is given in the appendix, in section [6.3 Debugging Controls feature availability](#).

Click the reference below to quickly find the *Debugging Controls* panel interface for the certain platform.

[GreenPAK Advanced Dev. Platform](#)

[ForgeFPGA™ Evaluation Board](#)

[GreenPAK DIP Dev. Platform](#)

[PowerPAK Dev. Platform](#)

[GreenPAK Lite Dev. Platform](#)

[PowerPAK Demo Board](#)

[GreenPAK Serial Debugger](#)

[GreenPAK Serial Debugger \(with SLG5100x\)](#)

[ForgeFPGA™ Advanced Dev. Board](#)

### Debug configuration

- *Recommended platform configuration* — find information about the supported adapter, development board and the devices' ordering information. Click on the platform name link to open the *Recommended platform configuration*

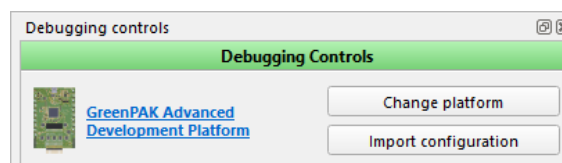

#### Recommended platform configuration

- *Change platform* — open the list of the development platforms that are supported by a Part Number
- *Import configuration* — upload configurations from a different development platform supported by a Part Number

## Device selector

- ▶ *Onboard/Chip in socket* — search the device placed on the board
- ▶ *External* — search the device on the selected I2C slave address
- ▶ *Auto detect/External, connected to 'I2C OUT'* — search the device on all available I2C slave addresses, starting from 0 until the first one is found

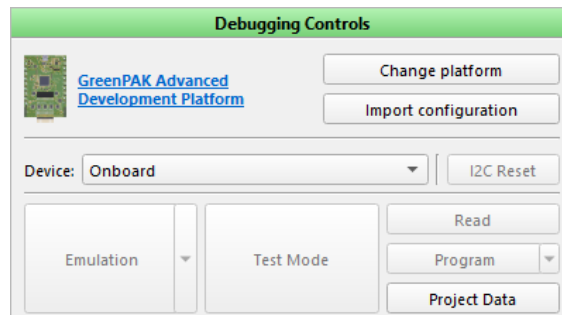

**Device selector**

**Note:** Make sure you do not connect the socket to the platform and external chip at the same time.

## External device modes

- ▶ *GPSD* — use a separate 4-pin connector (PWR, SCL, SDA, GND) for I2C communication
- ▶ *ECs* — use the expansion connector for I2C communication:
  - *VDD EC* — power
  - *SCL/SDA* — EC according to the chip TP map

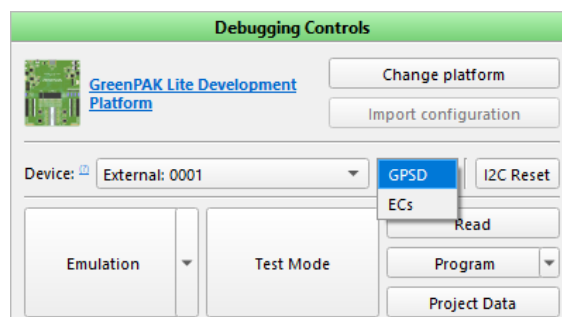

**Lite board device selector**

## Chip procedures

- ▶ *Test Mode* — debug the programmed project. Enable power and load the configured [hardware sources](#)
- ▶ *Emulation* — debug the current project. Enable power and load the design with configured [hardware sources](#)

- *Emulation(sync)* — the project changes are automatically loaded to the chip when the control is active
- *Sync* — load the current project to the chip once
- *Read* — read the programmed chip and open the project in the new software instance or in the *Project Data* window of the current instance
- *Program* — program the chip with the current project. For some Part Numbers, e.g. SLG47004, *EEPROM* programming is available
- *I2C Reset* — change the I2C reset bit (from 1 to 0). This causes the device to re-enable the Power-On Reset (POR) sequence, including the reload of all registers data from NVM

## Flash procedures

Flash memory is located on the FPGA sockets. See the available controls to work with it.

- *Test Mode(\*)* — load data from flash to the chip
- *Read* — read the chip project from the flash memory
- *Program* — program a flash memory with the current project
- *Erase* — clean flash memory (erased flash memory address values will be read as 0xFF)

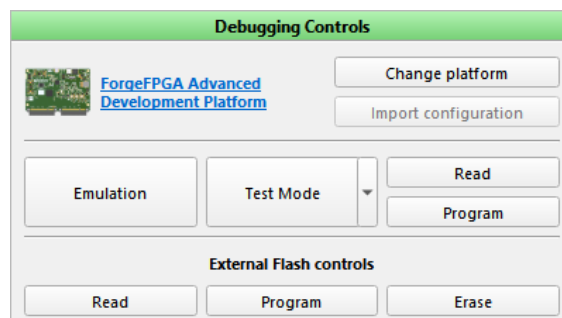

**Flash procedures**

## Project data window

- *Project data* — a table with *NVM/EEPROM* bit sequences. You can change the bit values, import/export the sequences and use data to program the chip (for more info see section 2.2.7 [Project data window](#))

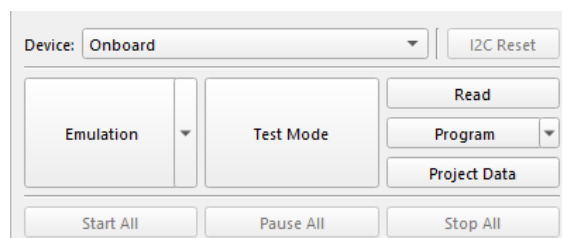

**Project data control**

## Generator controls

- ▶ *Start/Pause/Stop All* — control the generator state while *Global linkage* generator setting is enabled

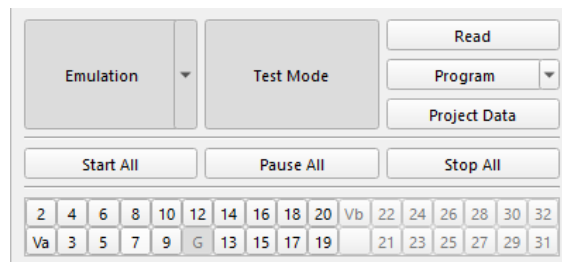

**Generator controls**

## Expansion Connectors (EC)

- ▶ *Expansion Connectors* — this port was designed to connect the platform to the external circuits and apply external power, signal sources, and loads. There are several ways to connect/disconnect the expansion connectors (also, control the ECs on the work area via a *hardware source*):

- Connect/Disconnect all ECs by clicking *ON/OFF* buttons
- Connect/Disconnect a specific EC by clicking the ECs *sequence number* button
- Connect/Disconnect *Va EC* by clicking the *Ext. VDD* button

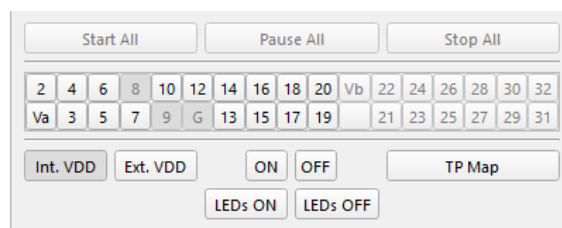

## Power source selector

- ▶ *Internal VDD* — the power is provided by the GreenPAK board
- ▶ *External VDD* — the board measures voltage on the active power connector, and provides the same voltage level

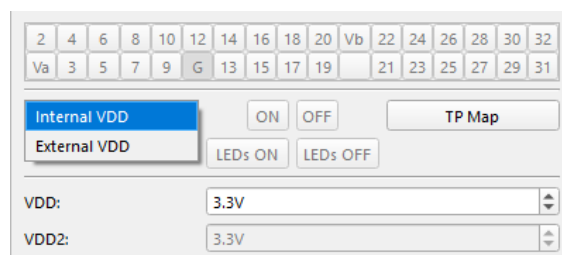

**Power source selector example**

## TP map

- ▶ *TP map* — show the test point map on the work area to reflect the physical test points on the development platform

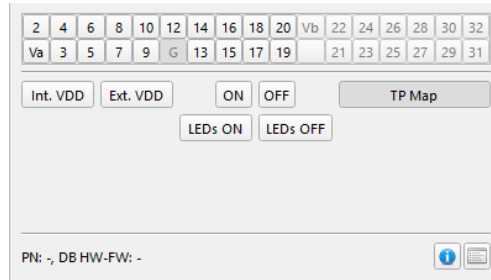

**Test point control**

## LEDs ON/LEDs OFF

- ▶ *LEDs ON/LEDs OFF* — enable/disable all LEDs on the current platform (applicable only for development platforms with LED support). You can control a particular LED on the work area via a [hardware source](#)

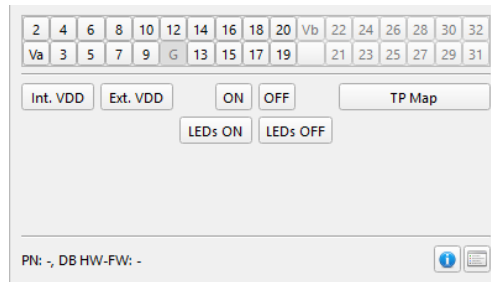

**LEDs ON/OFF controls**

## Voltage level controls

- ▶ *VDD* — set the voltage level on the corresponding test points. If a selected value exceeds any of the board limitations, the dependent controls are blocked, and a warning is shown.

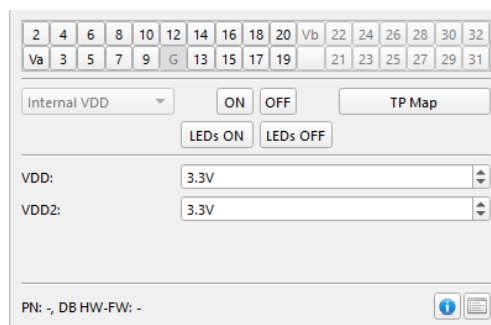

**Voltage level controls**

## PowerPAK voltage controls

- ▶ *VDD/VDDIO/VDDL* — power supply voltage for overall chip and GPIOs
- ▶ *VIN* — power supply voltage on the corresponding LDO component's VINs
- ▶ *VINs ON/OFF* — enable/disable all VINs

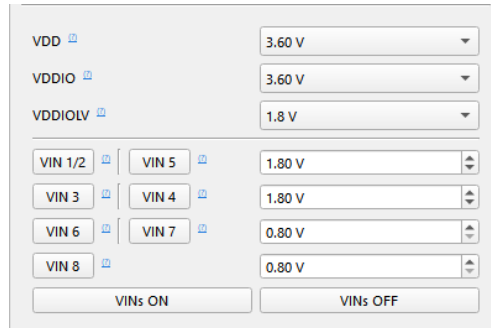

VDD	3.60 V	
VDDIO	3.60 V	
VDDIOLV	1.8 V	
VIN 1/2	VIN 5	1.80 V
VIN 3	VIN 4	1.80 V
VIN 6	VIN 7	0.80 V
VIN 8		0.80 V

VINs ON      VINs OFF

### PowerPAK voltage controls

## GPIO SW control

- ▶ *GPIO SW Control* — add buttons for software control of *GPIOs*, *GPIO(SDA)*, *GPI(SCL)* and *CS*. Read more in section [2.2.1 Hardware sources](#)

**Note:** the *GPIO SW Control* feature is permanently enabled in the *PowerPAK Development Platform*. For the *SLG51002CTR Demo Board*, you can activate the feature using the corresponding button in the *Debugging Controls*.

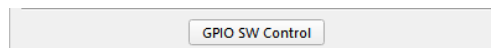

GPIO SW Control

### GPIO software control

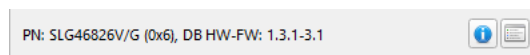

## Info details

Brief information about the connected chip and development platform (e.g, Part Number, firmware ID, etc.).



PN: SLG46826V/G (0x6), DB HW-FW: 1.3.1-3.1

### Info details

-  Information about the connected Part Number, development platform, software version, and operating system
-  Show operation log



## Board selector

Once the board is connected, the platform info appears on the bottom toolbar. To switch to a different platform, use the Board selector.

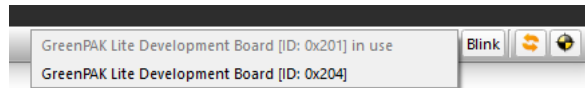

### Board selector

*Blink* Blink with an LED of the board in use

 Update the chip and board *Info details*

 Run the *Socket Test*

The *Socket Test* checks if the chip is successfully connected to the board. Click *Show Details* to get the *Socket Test* report.

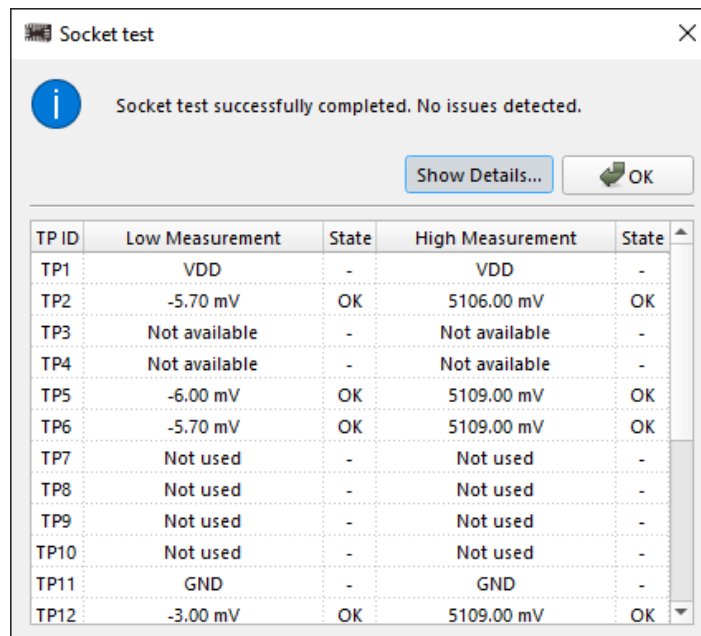

Socket test

Socket test successfully completed. No issues detected.

Show Details... OK

TP ID	Low Measurement	State	High Measurement	State
TP1	VDD	-	VDD	-
TP2	-5.70 mV	OK	5106.00 mV	OK
TP3	Not available	-	Not available	-
TP4	Not available	-	Not available	-
TP5	-6.00 mV	OK	5109.00 mV	OK
TP6	-5.70 mV	OK	5109.00 mV	OK
TP7	Not used	-	Not used	-
TP8	Not used	-	Not used	-
TP9	Not used	-	Not used	-
TP10	Not used	-	Not used	-
TP11	GND	-	GND	-
TP12	-3.00 mV	OK	5109.00 mV	OK

### Socket Test report

If the *Socket Test* fails for any reason, you can refer to the [Troubleshooting](#) section for assistance.

## 2.2.7 Project data window

This section contains the description of all *Project data window* controls.

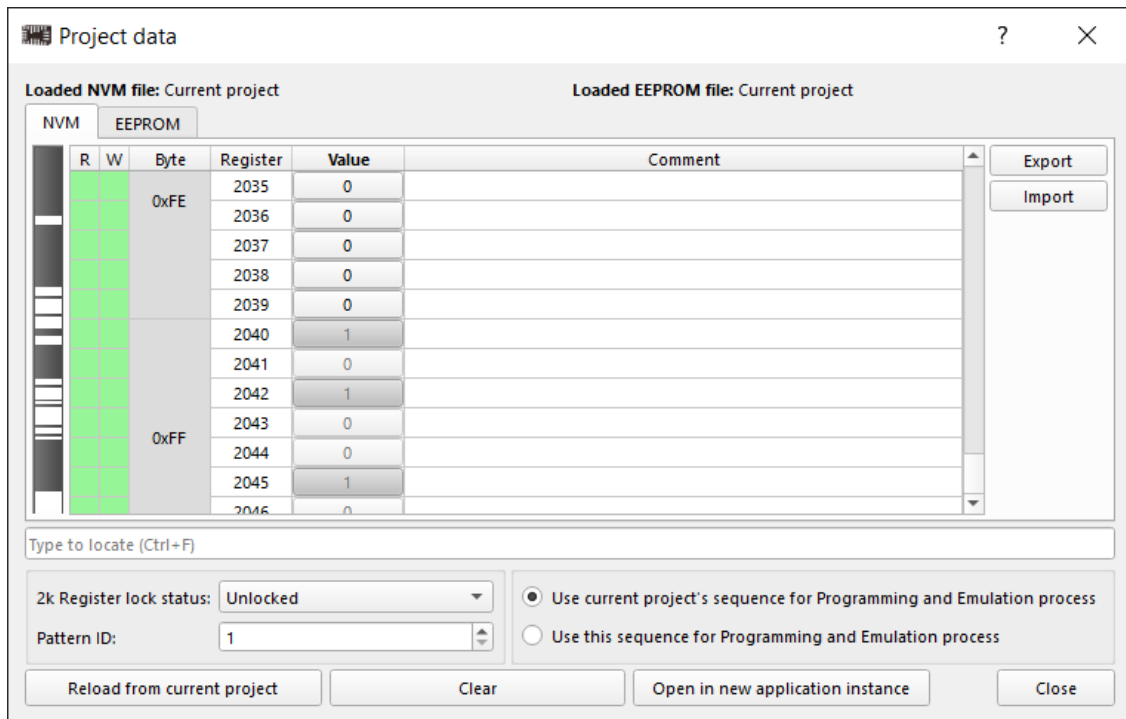

**Project data window with I2C Read/Write operations**

### Project data window table:

- *R* and *W* — show if a register is readable and writable
  - I2C operations allowed
  - I2C operations is not allowed
- *Value* — allow to change the bit value of a register
- *Comment* — add the notes

**Note:** The comments are stored neither in chip memory nor in the project file. However, you can *Export NVM* that includes the comments.

### Project data window controls:

- *Lock status* — lock *NVM Reading/Writing*. Use this control to determine the possibility of *Read /Write* operations
- *Pattern ID* — assign an *ID* to the current design
- *Use current project's sequence for Programming and Emulation process* — choose the bit sequence from *NVM Viewer* for the programming and emulation processes
- *Use this sequence for Programming and Emulation process* — choose the bit sequence from the *Project Data* table for the programming and emulation processes

- *Reload from the current project* — load bit sequence from the *NVM Viewer* to the *Project Data* table
- *Clear* — set the whole *Project Data* table's bit range to 0
- *Open in a new application instance* — open the bit sequence from the *Project Data* table in a new software instance
- *Export* — save the bit sequence to a text file
- *Import* — load the bit sequence from a text file

You can find the required byte or register by typing its number in the search field. To filter out bytes or registers from the search, use the following markers:

- *b* — searching for bytes only
- *r* — searching for registers only

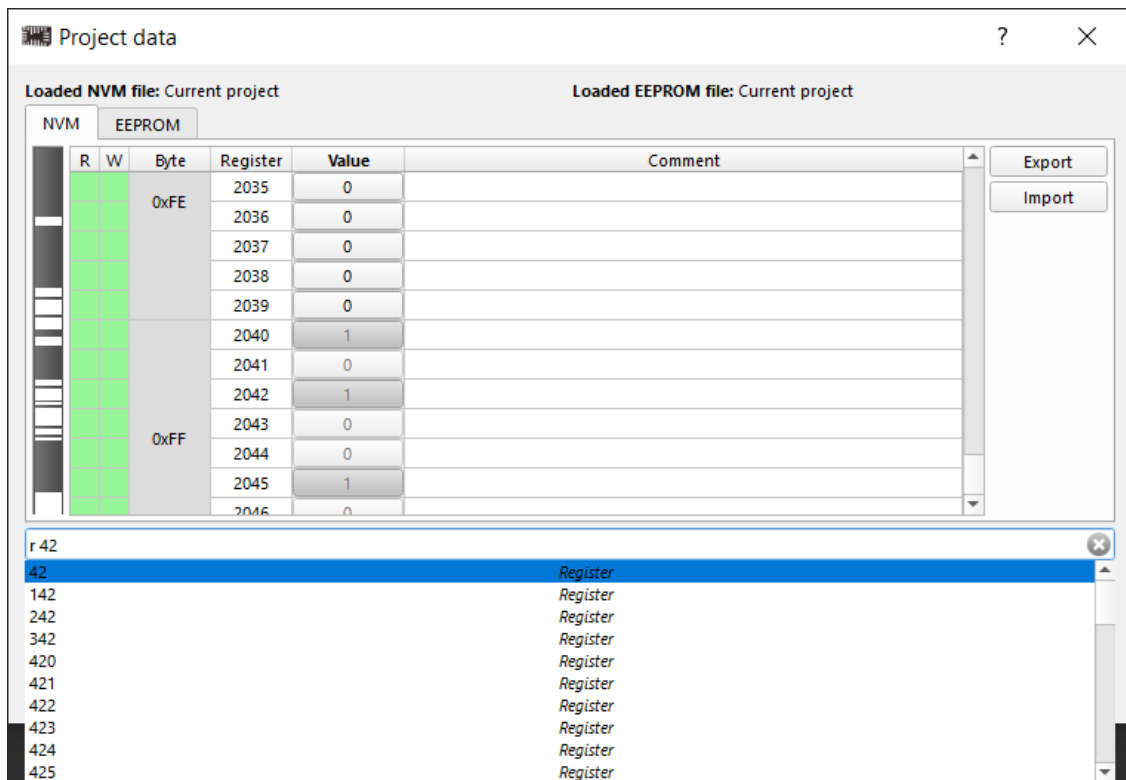

**Searching for registers**

## 2.2.8 Demo Board and Demo mode

The *Demo* mode allows exploring possible applications of a specific Part Number. The *Demo* tab on the *Hub* window contains the list of the preconfigured projects. Click *Details* to find out more about the design. To open the project click *Run*.

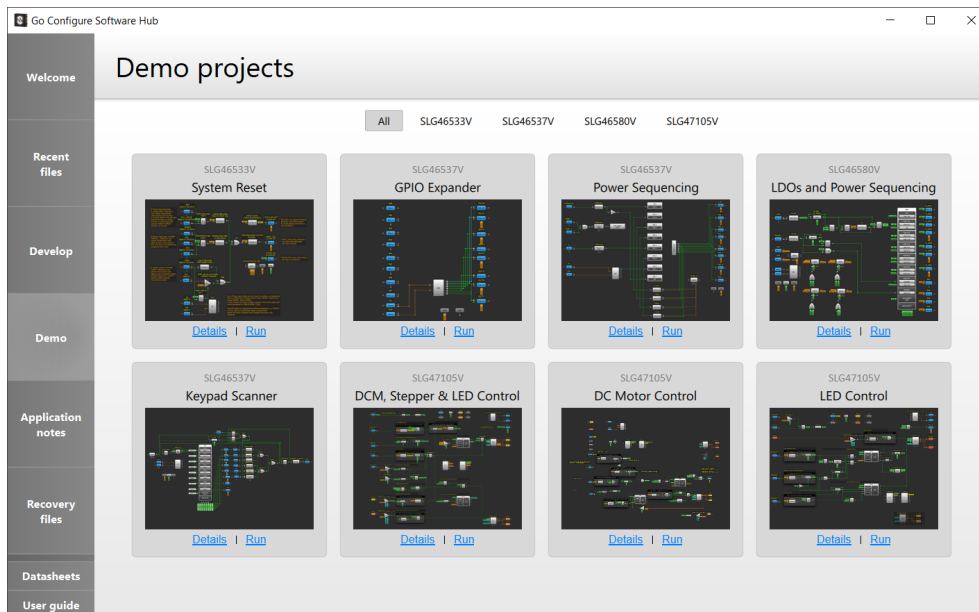

### Select a Demo project

To interact with the design, you can connect the specific *Demo Board*. Such board contains a soldered IC with a preprogrammed project.

Once you open the project, the workspace UI depends on whether the *Demo Board* is connected.

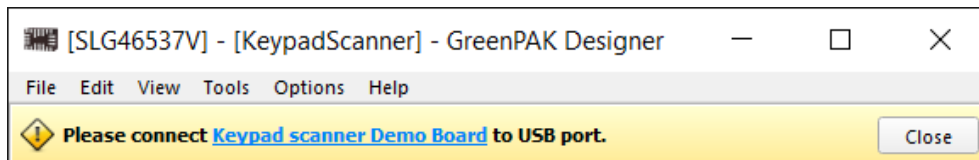

### Waiting for the corresponding Demo Board connection

After the board detection is successful, the following controls become available:

- *Write* — load the current project's NVM sequence to the device
- *I2C Tools* — the following I2C Tools are available for *Demo* mode:
  - *I2C Virtual Inputs*
  - *I2C Virtual Outputs*
  - *I2C Reconfigurator*

For more information refer to section [2.2.9 I2C Tools](#).

-  — information about a Part Number, development platform, and operating system
- *Close* — exit the *Demo* mode

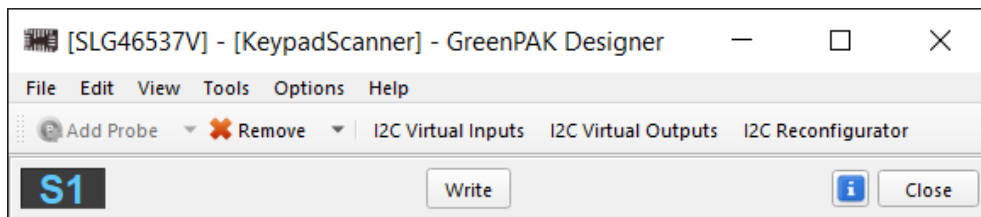

**Demo Board detected**

**Note:** The *Demo* mode applies some limitations on specific features (operations with the project files, *Debug Tool*, *Simulation*). Exiting the *Demo* mode removes all limitations, yet keeps the current project open.

### 2.2.9 I2C Tools

The I2C Tools are the instruments that help to debug the project configuration by reading or writing the register data on the chip.

A chip's I2C communication macrocell allows an I2C bus master to read and write information at any moment via a serial channel directly to the registers via I2C protocol. The tool allows configuring the macrocell data on the fly.

Once you enable *Debug* utility and select the platform, the following I2C Tools appear on the toolbar: *I2C Virtual Inputs*, *I2C Virtual Outputs*, and *I2C Reconfigurator*.

**Note:** To read/write data via I2C Tools, *Emulation* or *Test Mode* is required.

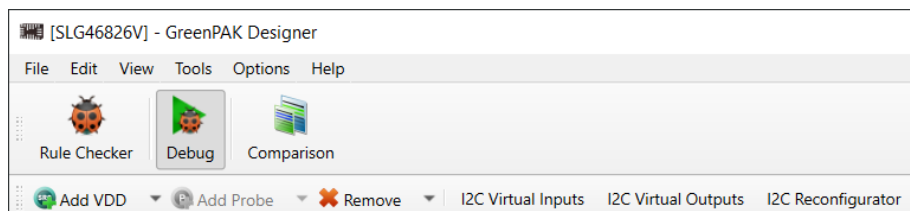

**I2C Tools on the toolbar**

### I2C Virtual Inputs

The I2C Tools contain the following instruments (the set of tools depends on the selected Part Number):

- *Counters/Delays* — allows to read/write the counter data of a specific macrocell configured in

## CNT/DLY mode

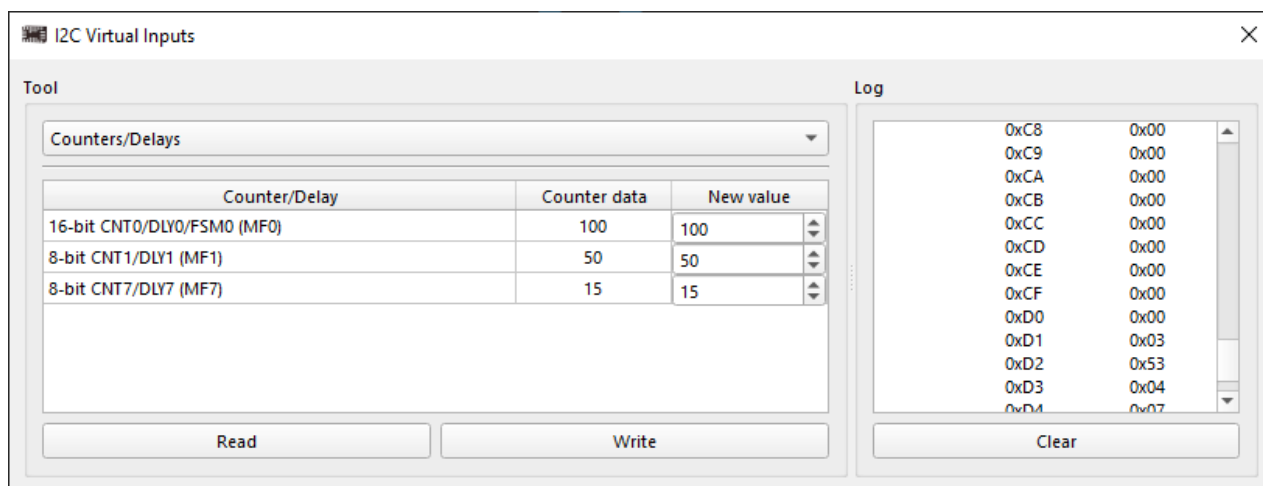

**Managing Counters/Delays**

- ▶ *I2C Virtual Inputs* — allows you to read/write I2C virtual OUTs values of the I2C macrocell

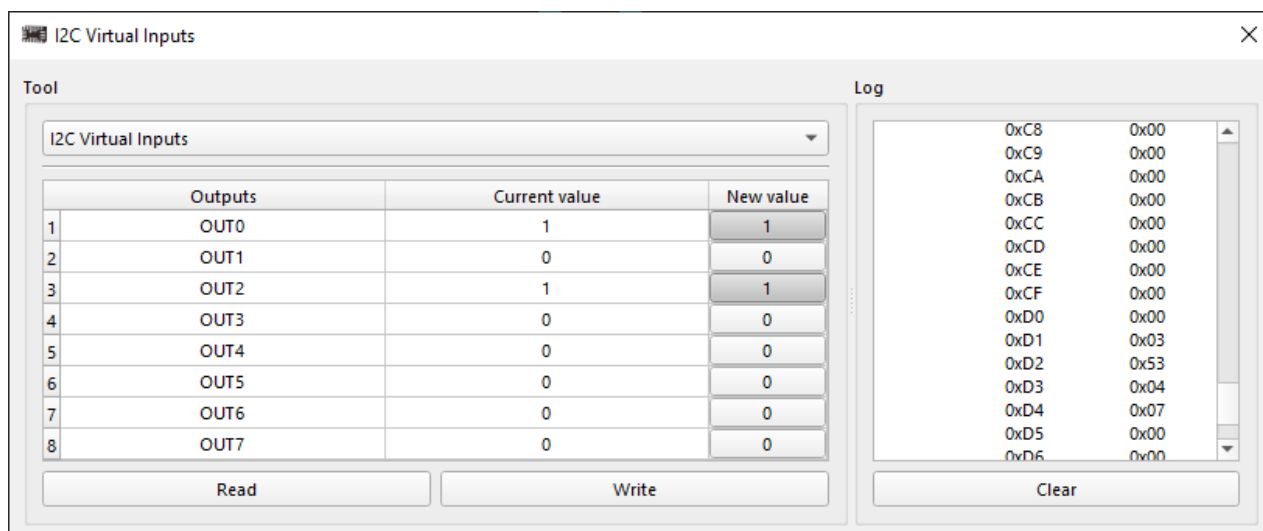

**I2C Virtual Inputs**

- ▶ *Registers* — allows you to read/write all of the chip registers data. It is possible to read/write:
  - the certain register in each row
  - all registers using the bottom buttons

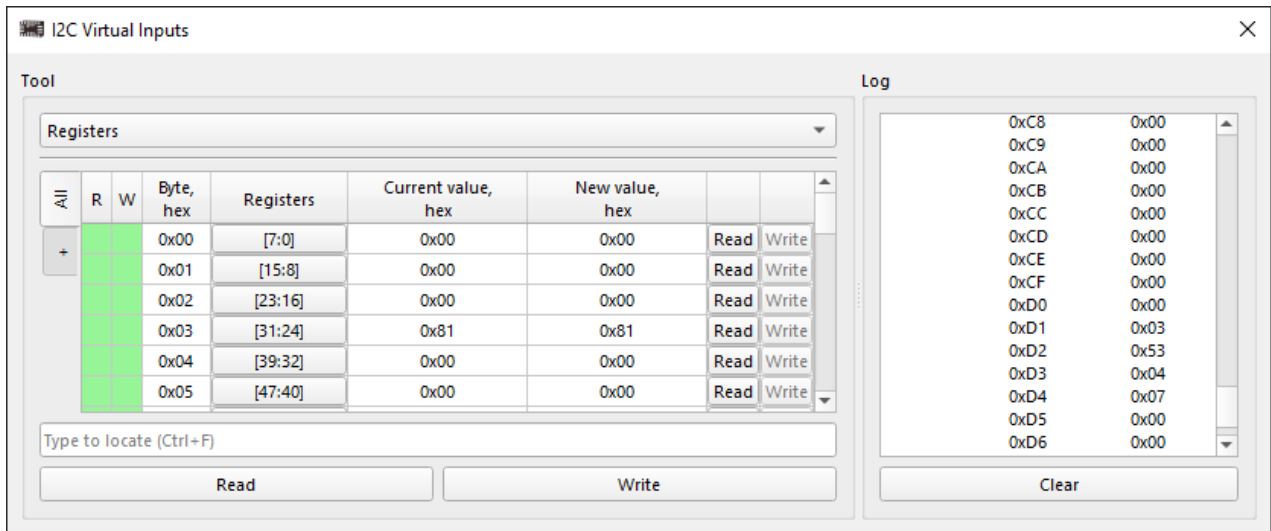

### Read/Write the registers data

You can edit a register value in the following ways:

- enter the value in the *New value* column
- change the register bits by clicking a cell in the *Registers* column

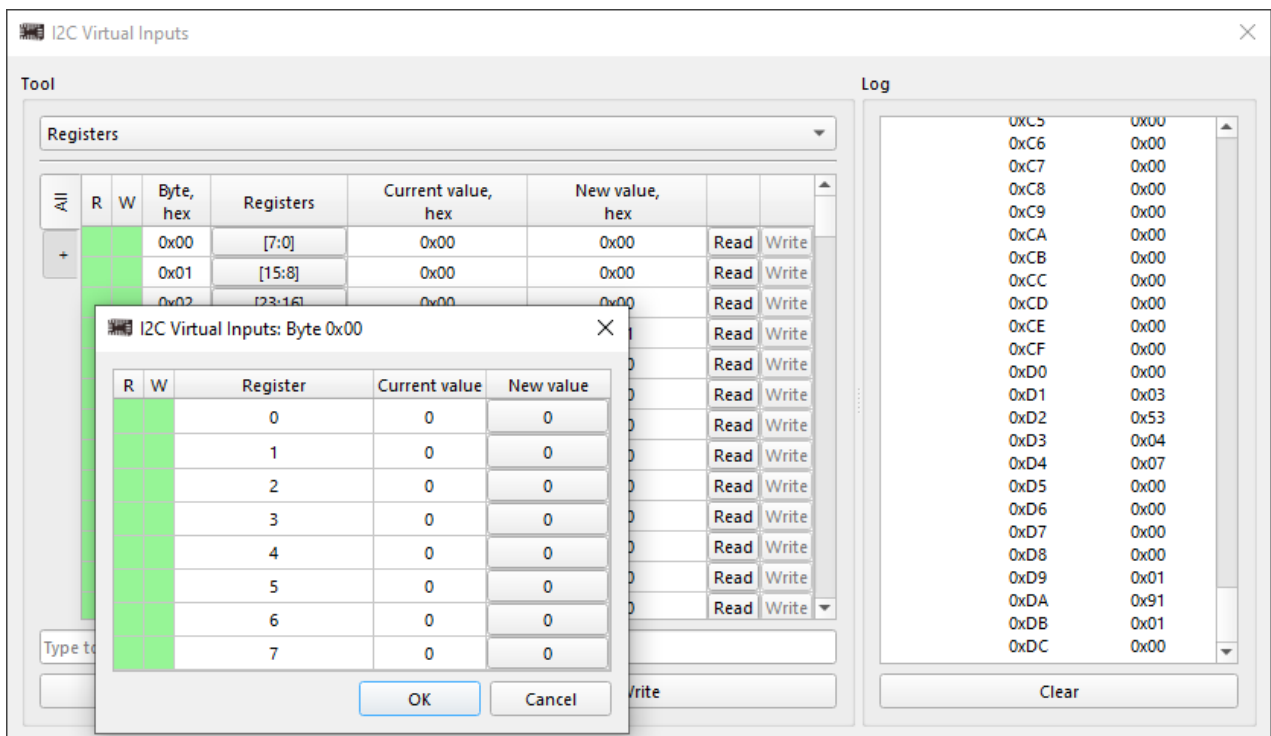

### Registers modification options

You can find a required byte or register(bit) by using the pattern below:

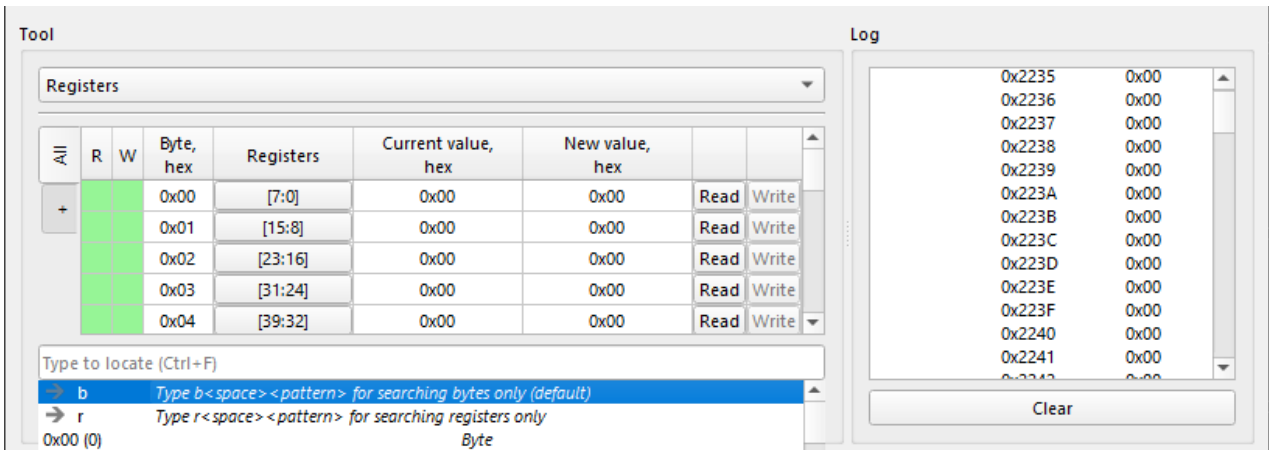

**Filter options**

The *Registers* tool allows creating tabs with specific register ranges. Add a new tab by clicking the button under the *All* tab and the **+** and add entries with register ranges.

**Note:** Only the registers present under an active tab are read upon clicking the bottom *Read* button.

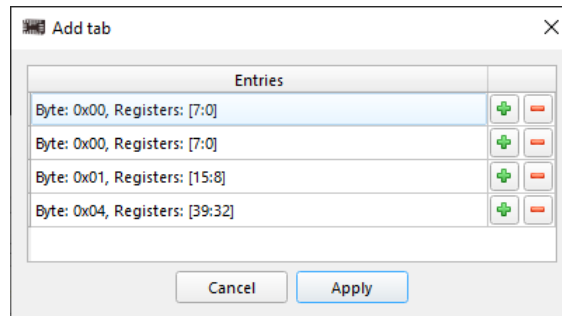

**Add tab**

You can also open the context menu for some additional options: edit, rename, or remove the tabs; switch between the hex or decimal value formats.

Remove a tick from *Update current value after write* checkbox if you do not wish to read the



overwritten values.

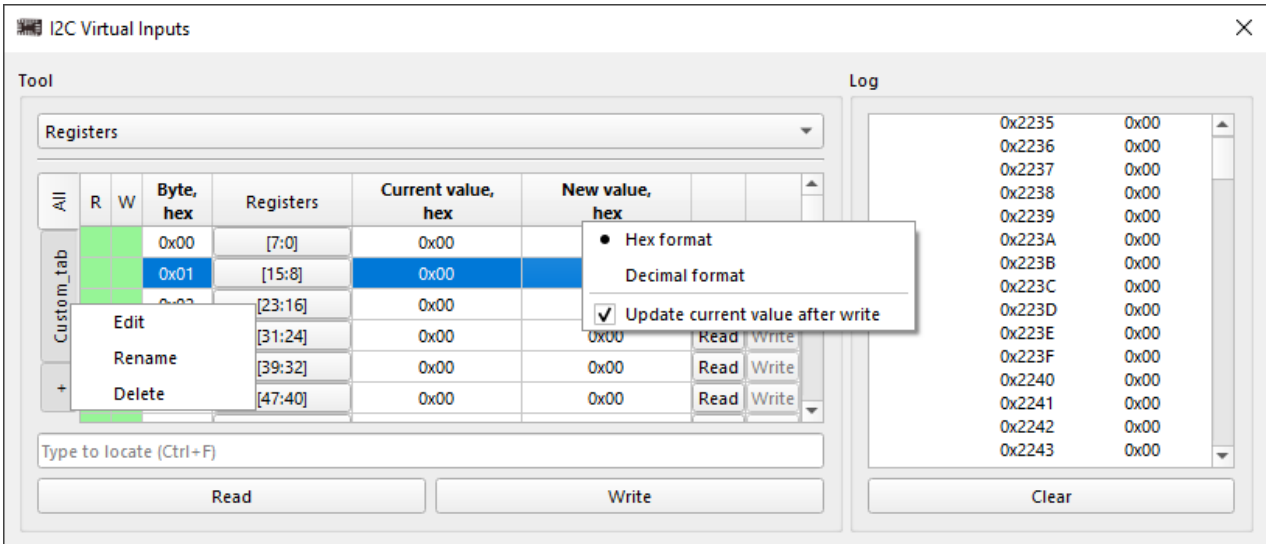

### Context menus

The *R* and *W* columns show if a register is readable/writable:

- I2C operations are supported
- I2C operations are not supported
- I2C operations are unsupported for some bits of the register

➤ *Data Buffers* — allows you to read data from the Data Buffer macrocells and the *ADC data register*. For automatic data actualization, click *Read* while the *Auto read every 1s* option is enabled

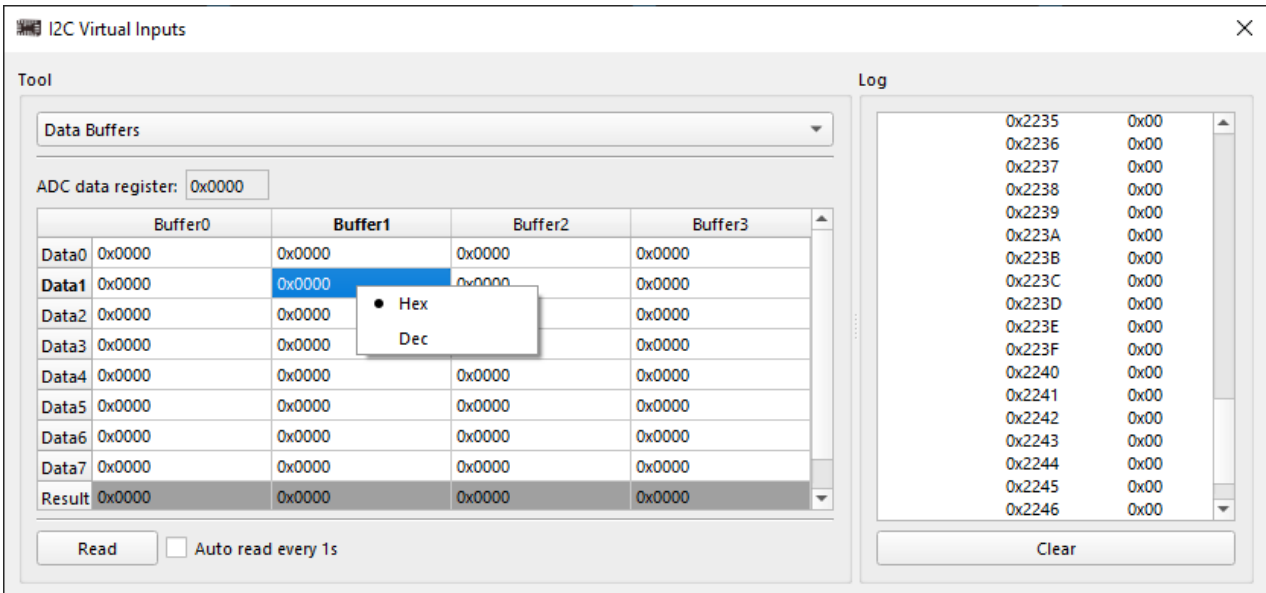

### Managing Data Buffers

➤ *Memory Table* — read data from the Memory Table macrocell in the *Column X* section. To change the amount of displayed columns use the *Columns* selector. In addition to the decimal

and hexadecimal formats, applicable for both column types, the *Address* columns data view can be also changed using the following options:

- *Absolute* — show the actual address of the register in the macrocell
- *Relative* — show the register address starting with zero

You can save the read data in .csv format by clicking the *Export to file* button.

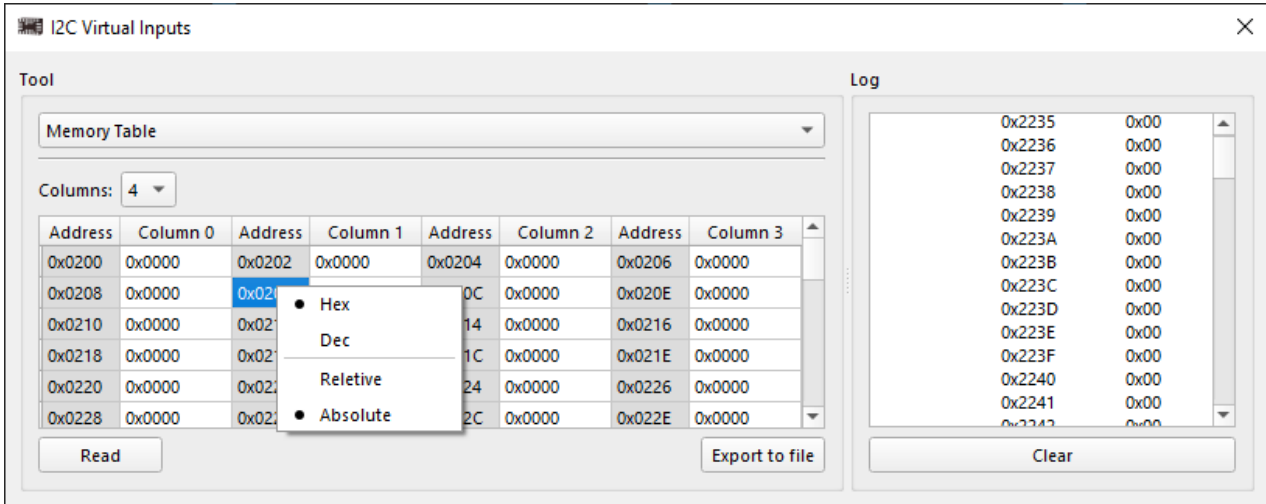

**Managing Memory Table**

- *Speed control* — displays and allows to read/write the constant of the Scalers and Speed/Torque Control macrocells

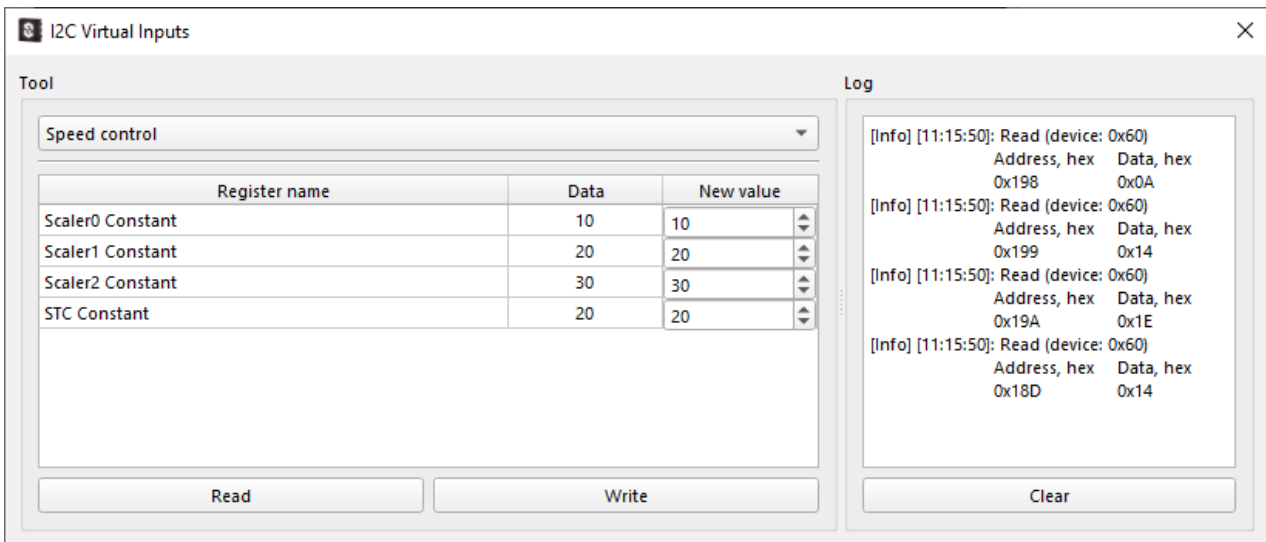

**Speed control tool**

- *Log* — the results of recent read and write operations. The *Log level* has three severity

settings, such as *Debug*, *Error* and *Info* displaying the most/least detailed information

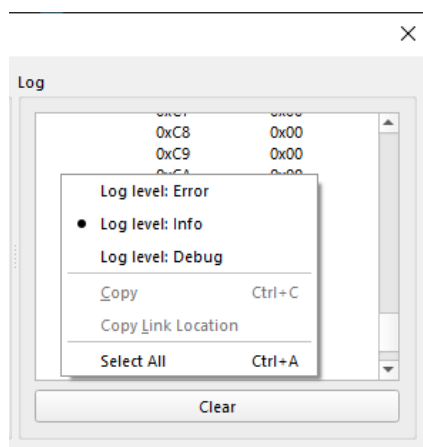

**Log context menu**

## I2C Virtual Outputs

*I2C Virtual Outputs* allows you to read the state of certain macrocells. The tool includes the hardware probes, ASM state, and the current counted data of the specific counters.

- *Probes (Matrix inputs)* — reflect the current logic level on the macrocell output pins. You can add a probe by clicking *Add Probe* and then the required pin. Internal pins that support adding a probe are highlighted in green. Also, you can add probes to all visible pins at once by clicking *Add Probes to visible pins*.

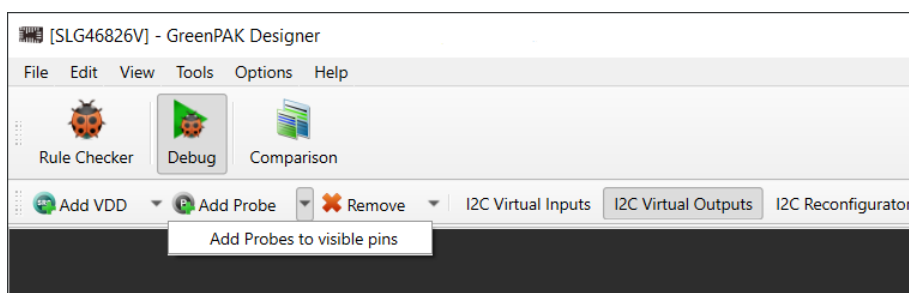

You can remove probes one by one or remove all probes at once.

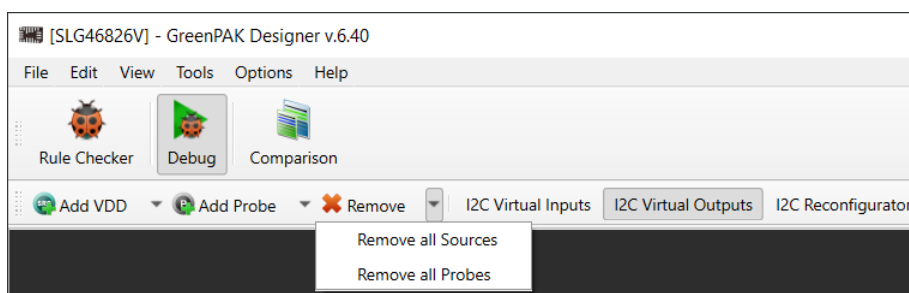

- *I2C Virtual Outputs* tool — displays the current value of the components, such as e.g. CNT/DLY, ASM, Scaler, DCM, etc., read from the chip registers (see the Datasheet for the selected Part

Number). To refresh the data click the respective button on the tool panel

Macrocell	Property	Value
16-bit TIMER0 (MF0)	Counted Data	132
8-bit TIMER1 (MF1)	Counted Data	132
8-bit TIMER2 (MF2)	Counted Data	132
8-bit TIMER3 (MF3)	Counted Data	132
8-bit TIMER4 (MF4)	Counted Data	132
16-bit TIMER5 (MF5)	Counted Data	132
16-bit TIMER6 (MF6)	Counted Data	132
Scaler0	Scaled Data	5
Scaler1	Scaled Data	10
Scaler2	Scaled Data	15
Speed/Torque Control	STC OUT	1029
ADC	ADC Data	66

**I2C Virtual Outputs tool**





## I2C Reconfigurator

*I2C Reconfigurator* allows changing chip data dynamically by sending *NVM* snapshots to the chip. Snapshots are diff-based lists of changes. Each includes macrocell configurations and connections.

On	Name	Value
<input checked="" type="radio"/>	Snapshot @12:21:07	
<input type="radio"/>	Delay	100 ms
<input checked="" type="radio"/>	Snapshot @12:21:11	
<input type="radio"/>	Delay	100 ms

**Snapshot configuration**

You can work with the *Reconfiguration scenarios* using the following controls:

-  add a snapshot of the work area
-  add a delay between snapshots
-  move the selected list item one level up
-  move the selected list item one level down
-  remove the selected list item

To see the list of changes which are applied, refer to *Reconfiguration scenario* controls:



open a dialog with the list of changes applied; delays are included. You can also export the whole list to a file



Import presets from a different project

Here is the list of snapshot sending controls:

- ▶ send the next snapshot to the chip and pause list execution
- ▶ send snapshots along with delays one by one continuously
- stop sending snapshots and reset the list pointer

You can also manipulate the selected snapshot using the following buttons:

- ▶ *Load* — send the configurations of the selected snapshot to the chip
- ▶ *Overwrite* — make the desired changes and substitute the existing snapshot data

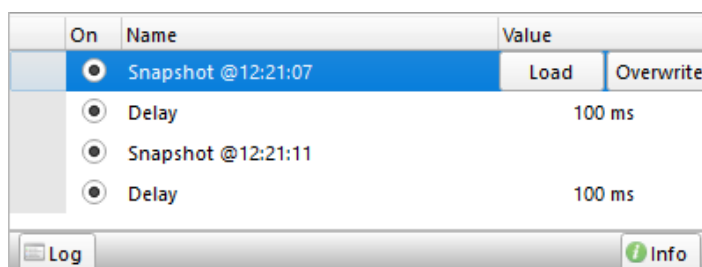

**Load/Overwrite snapshot configurations**

- ▶ *Reset* — the button becomes available once you load a snapshot clicking the *Send one* button and make any configuration modifications afterwards. Click the button to return the snapshot to the primarily saved state

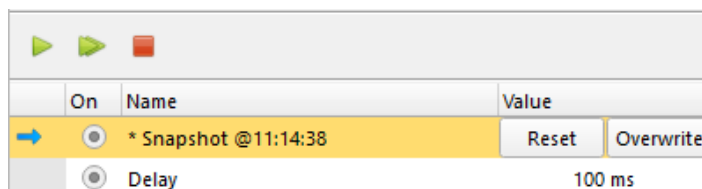

**Reset snapshot configurations**

The *Log* utility displays the changes applied to the chip. As delays don't imply any changes to the chip, they do not appear in the *Log*.

## 2.2.10 I2C I/O Tool

Just like *I2C Tools* described above, *I2C I/O Tool* allows debugging the project configuration by reading or writing the register data on the chip (the tools type depends on the selected Part Number).

Once you enable *Debug* and select the required platform, the *I2C I/O Tool* button appears on the toolbar.

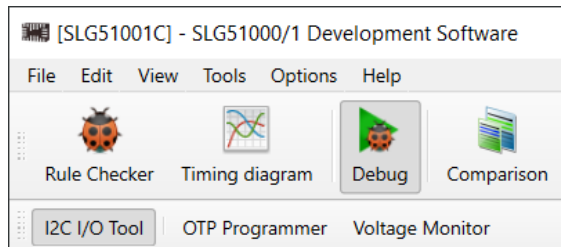

### I2C I/O Tool on the toolbar

The following instruments are included: *Registers*, *Counters/Delays*, *Events / Current states* and *Raw I/O*.

**Note:** To read/write data via I2C I/O Tool, *Emulation* or *Test Mode* is required.

- *Registers* — the tool is mostly the same as *Registers* in *I2C Tools*. The slight differences are described below.

Click the *Address* column cell to open the *Byte view* window:

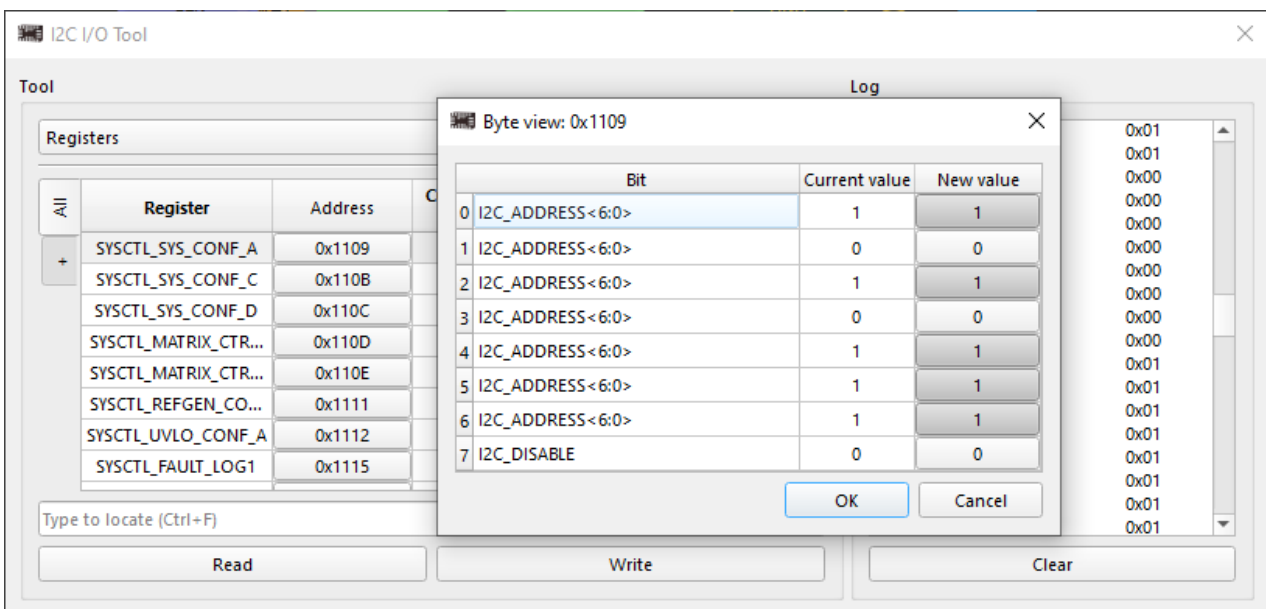

### Change specific bit

Search by byte or register name is available:

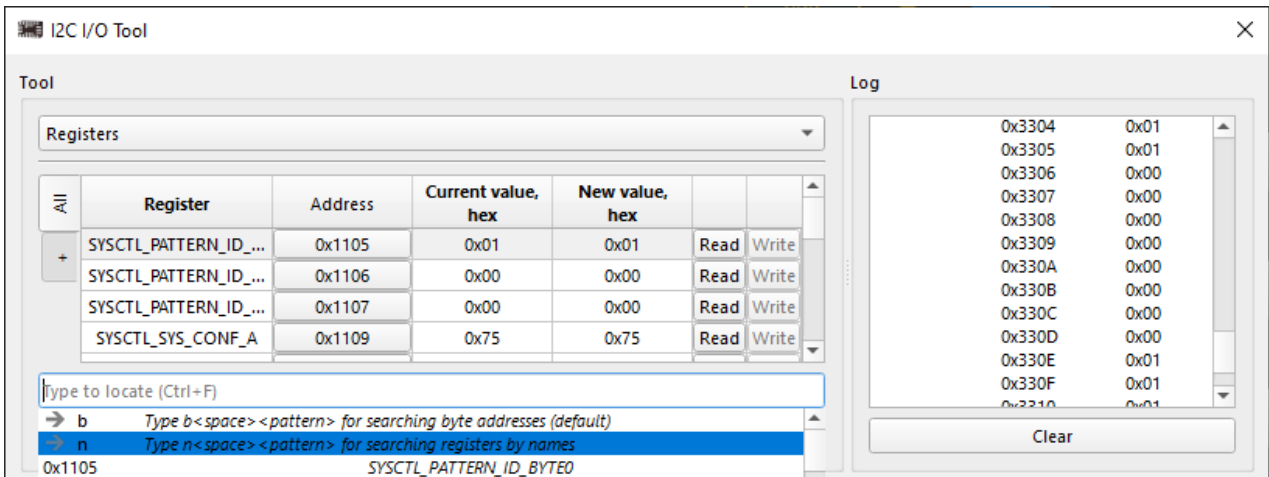

**Search by byte or register**

- *Counters/Delays* — same description as in *I2C Tools* section is applicable
- *Events/Current states* — shows the read-only list of the specific components' (e.g. LDO, CNT/DLY) events

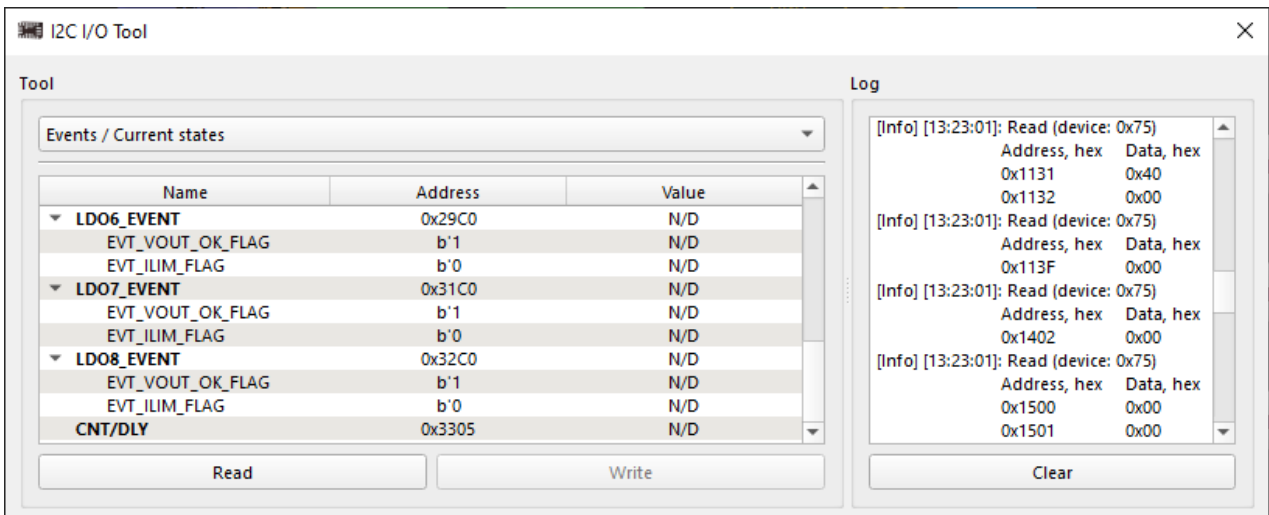

**I2C I/O Tool window with events**

- *Raw I/O* — provides extended access via I2C to the chip registers. It allows reaching the

registers that may be inaccessible from the *Registers* instrument

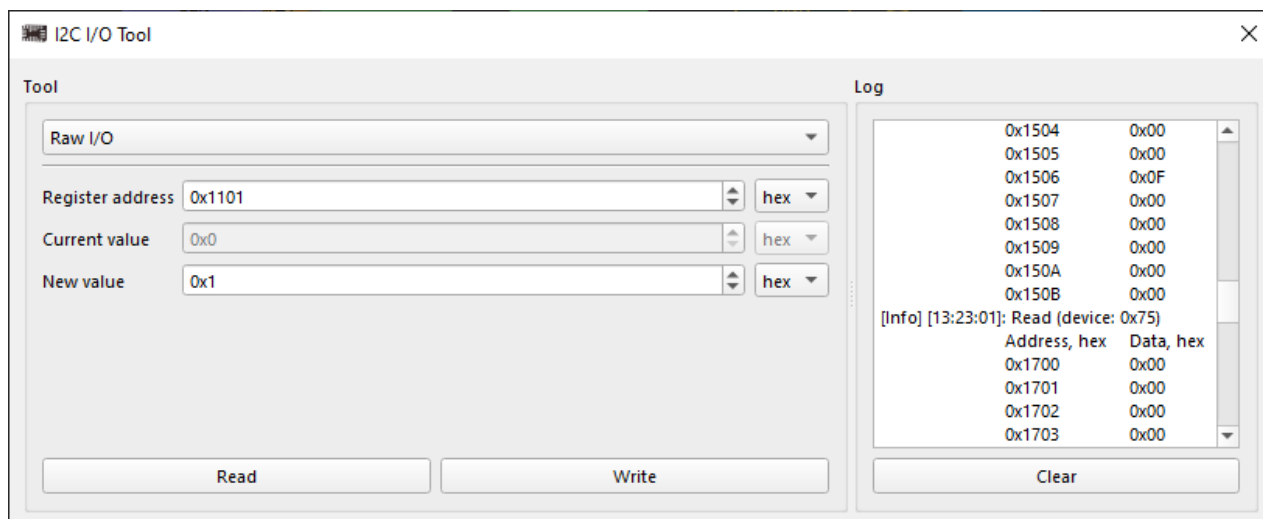

**I2C I/O Tool window with Raw I/O**

- *Log* — refer to [I2C Tools](#) section

## 2.2.11 Logic Analyzer

*Logic Analyzer* tool allows you to capture multiple signals from a digital circuit. It includes triggering capabilities and a protocol decoder that helps to see the timing relationships between multiple signals and decode them.

The characteristics of *Logic Analyzer* are the following:

- Frequency range (500 Hz - 200 MHz)
- Buffer size (16384 samples)
- I2C, Parallel, SPI, and UART protocol support



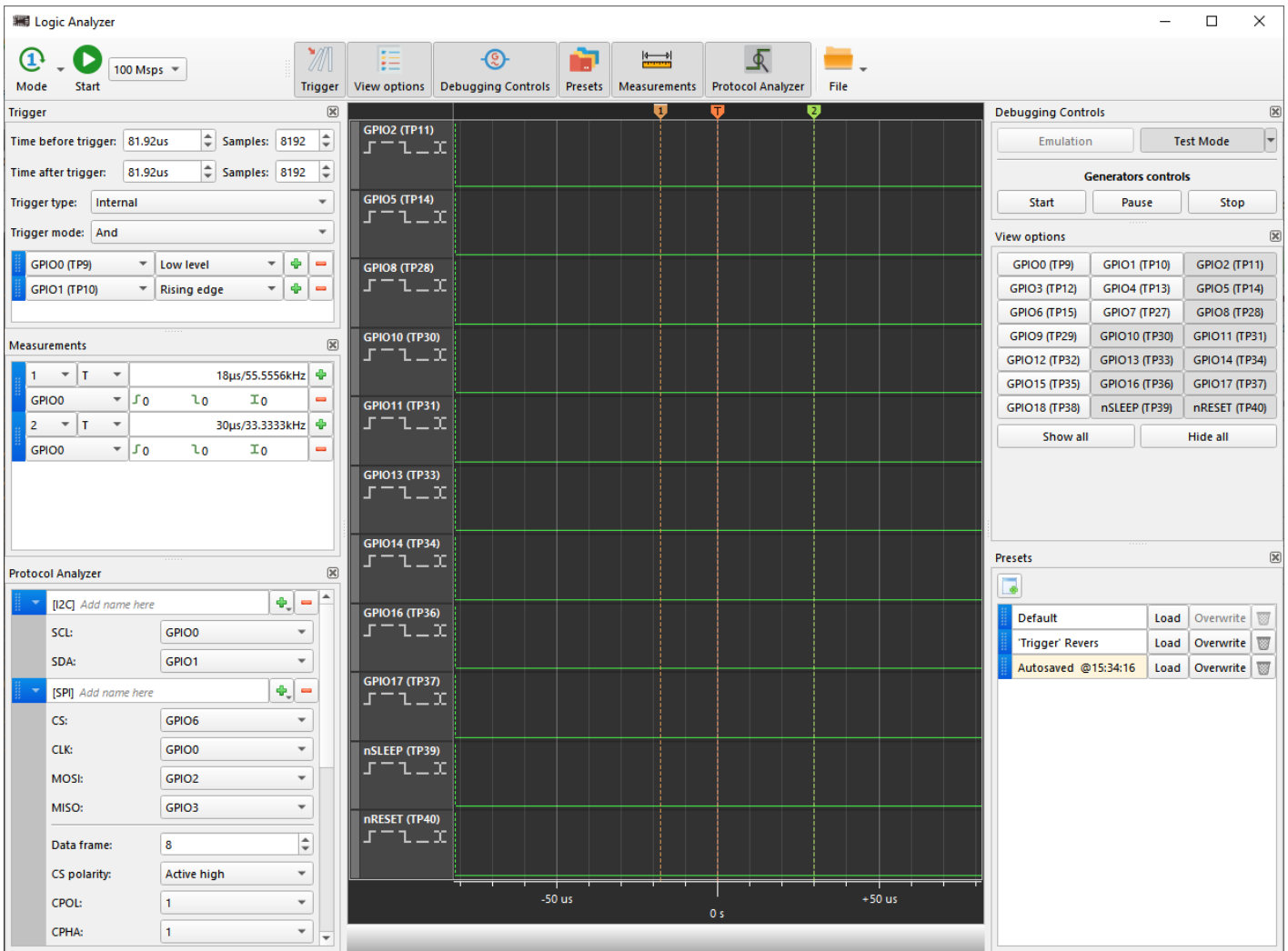

Logic Analyzer window

## Main operational controls

- *Mode* — three operating modes are available:
  - *Auto mode* — trigger events are ignored. The signal on the pins is shown as a continuous waveform
  - *Single shot* — refreshes the waveform pattern once a trigger event is detected
  - *Normal mode* — refreshes the waveform pattern each time when a trigger conditions are met
- *Sampling rate* — drop down selector of the signal sampling frequency
- *Start* — launch *Logic Analyzer*. The *Start* button becomes active after *Emulation* or *Test Mode* is started

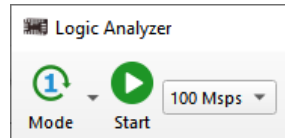

**Main controls**

## Triggers

Set time parameters to choose the trigger time position or a specific sample.

Chose between the following trigger types:

- *Hardware button* — the trigger is activated by pressing a physical button on the board
- *Internal* — the trigger is activated when the trigger condition, which is set in the trigger list, is met. Additional settings are available for the *Internal* trigger type:
  - *Trigger mode* — depending on the selected option (*And/Or*), any or all of the trigger conditions added to the trigger list will be met
  - *Trigger list* — add/remove triggers, assign the trigger to the channel, and select the trigger conditions among the following: *Rising edge*, *Falling edge*, *Both edges*, *High state*, and *Low state*

**Note:** Set proper trigger conditions for successful sampling (e.g. *Rising edge*, *Falling edge* together with *And* trigger mode may result in improper trigger work).

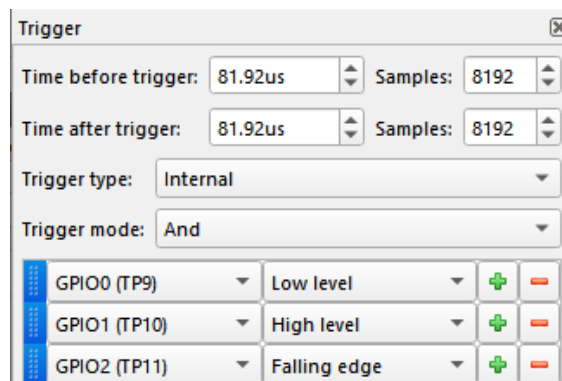

**Trigger parameters**



**Trigger configuration**

## Protocol Analyzer

The *Protocol Analyzer* allows you to decode data according to a protocol.

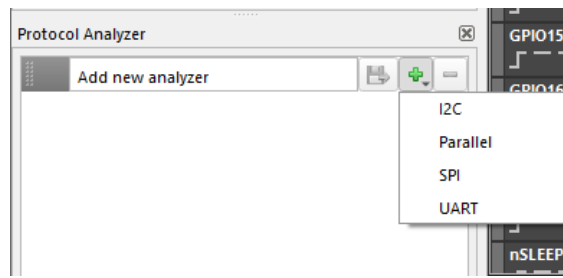

**Protocol Analyzer**

To analyze captured data, click the **+** button and select one of the protocols.

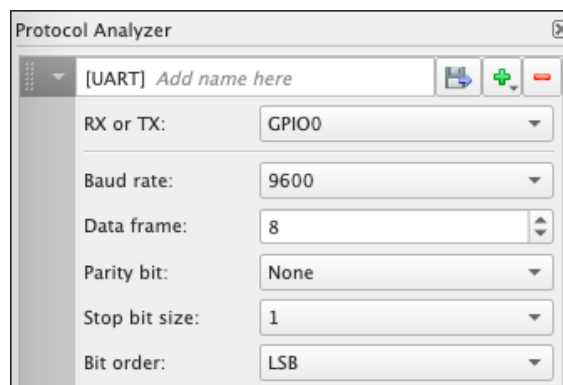

**Protocol settings**

Then, choose a channel for analysis and modify protocol settings if necessary. The decoded data will be displayed above the corresponding plot.



**Decoded data**

You can easily export data from a *Protocol Analyzer* by clicking the *Save* button next to the *Protocol Analyzer* name field. If the parameters are selected correctly, an automatic download of a CSV file will initiate.

## Import / Export actions

You can save/import the waveform data in the CSV format. These options are grouped under the

File button at the top toolbar.

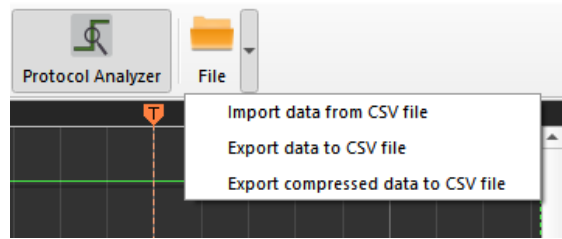

**Export and import operations**

## Plot widget

The plot widget displays the waveforms in the *Logic Analyzer* window. You can change the way a plot is shown from the plot context menu. Right-click on a plot area to add a **marker**, show or hide the time scale, change the plot height, and select the **cursor** width.

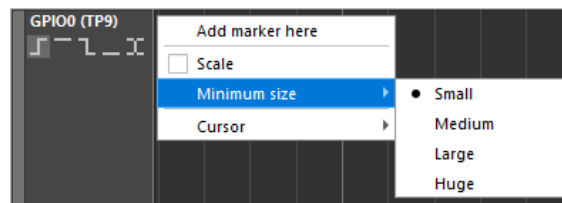

**Logic Analyzer Plot menu**

You may do the following actions with the plot area:

- ▶ Move left/right by click + drag left/right
- ▶ Zoom in/out by **Ctrl** + mouse wheel up/down
- ▶ Quick zoom in/out with the **MMB** click + drag up/down
- ▶ Reorder waveforms by drag and drop

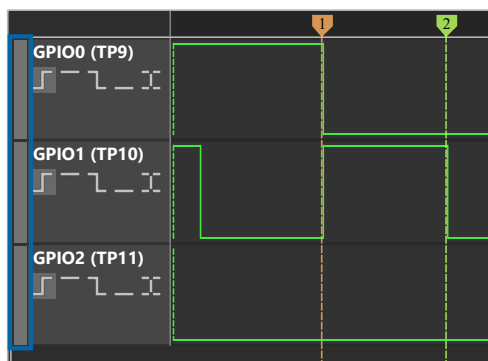

**Drag and Drop Handlers**

## Markers

You can do the following actions with markers:

- Add a new marker with a `Ctrl + LMB` click on the markers panel
- Set a new marker from the plot's context menu
- Remove the marker with a `Ctrl + RMB` click on the marker head
- Move the marker by a `LMB` click + drag
- Move the marker from the context menu by a `LMB` click on the marker's head

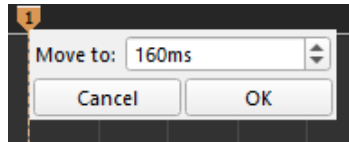

**Marker Move To**

- Select the marker by clicking on the marker head: the selected marker has a white line on top.
- Move the selected marker to the closest visible left/right front by `Ctrl + Left/Right`
- Move the selected marker left/right by one sample with `Ctrl + Shift + Left/Right`

## Marker measurements

- Measurements — period and frequency. Frequency value is rounded to four decimals
- Additional measurements — the count of *Rising Edges*, *Falling Edges*, and *All Edges* in the period between the markers

To calculate all measurements between two markers, select the markers and a channel in combo boxes.

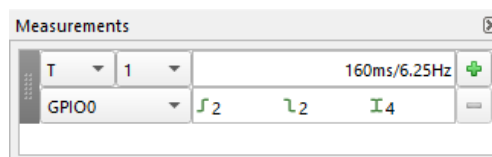

**Markers measurements**

## Cursors

A cursor is a measurement tool for calculating waveform data between the edges of one or more plots. To see the cursor, hover a measured section of a waveform.

A *Half Period* cursor measures the distance between the two nearest edges at a hovered section of a

waveform.

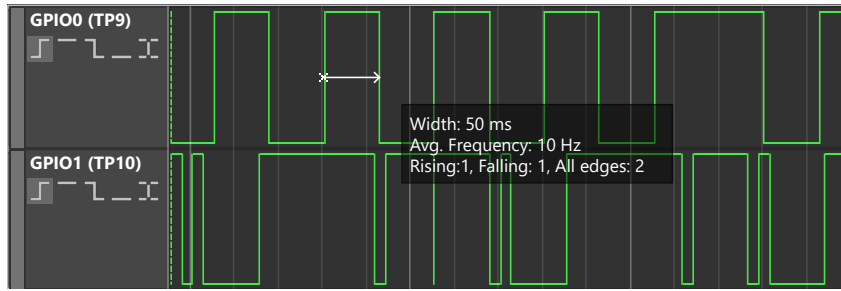

**Half Period cursor and sample measurements**

A *Period* cursor measures the width of the hovered half period, the duration of a full period, calculates the frequency, and which fraction of the full period the hovered part of the period is, which is the *Duty cycle*.

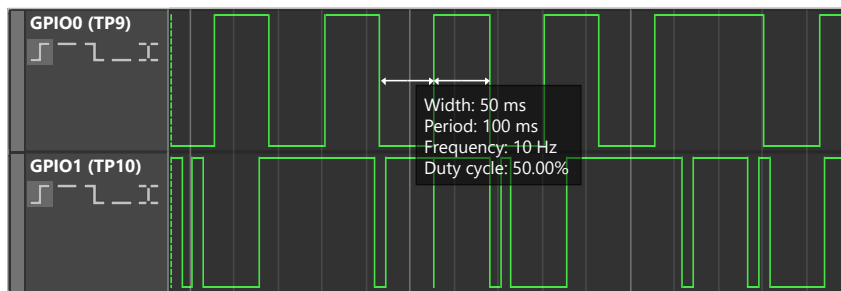

**Period cursor and sample measurements**

To change the cursor width, open the context menu and select either the *Period* or *Half Period* option.

To measure data at a distance that exceeds one period, click the edge you want to measure from and hover over the edge you want to measure to. This will give you the total duration of the measured section, the calculated average frequency, and the quantity of rising and falling edges as well as their sum.

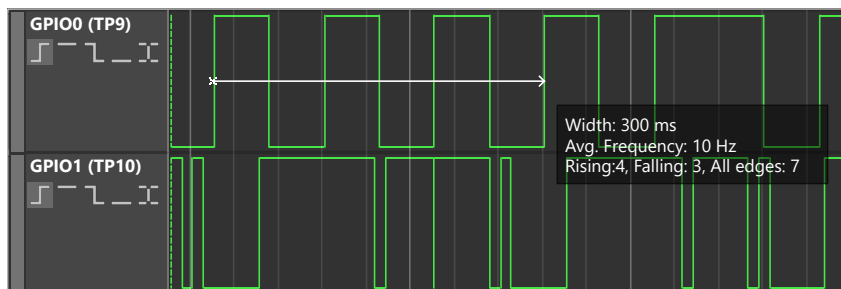

You can also measure the width between the edges on the distinct waveforms.

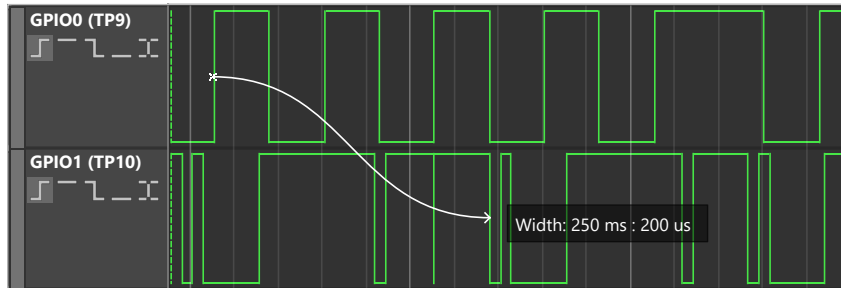

## View options

Click the channel in the *View options* panel to show/hide the corresponding plot on the plot widget.

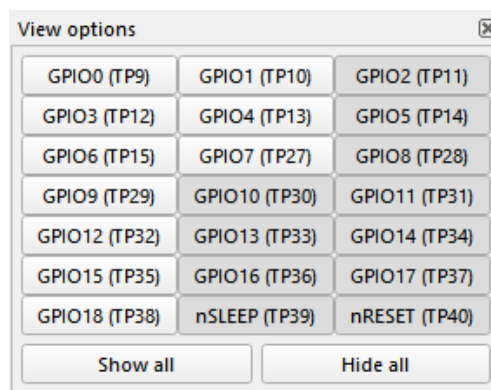

**View options panel**

## Debugging Controls

The *Debugging Controls* panel is responsible for *Emulation* and *Test mode* chip procedures, along with *Generator controls* functionality.

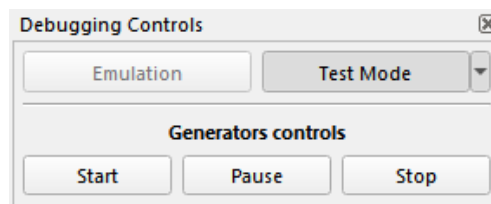

**Debugging controls**



## Presets

You can store your *Logic Analyzer* configurations in presets and restore a previous configuration when

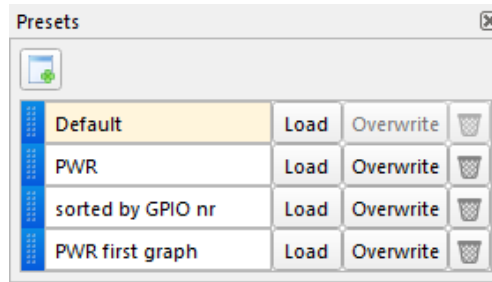
needed.



Presets

-  — create a new preset with the current *Logic Analyzer* configuration
- *Load* — load a selected preset configuration
- *Overwrite* — overwrite preset with the current *Logic Analyzer* configuration
-  — remove the selected preset
- *Default* — load the Default preset of the *Logic Analyzer* window
- *Autosaved @ [time]* — the modified preset is saved each time the *Logic Analyzer* window, the *Debug tool*, or *ForgeFPGA* Workshop is closed

## 2.2.12 UART Terminal

*UART Terminal* is a console tool used for serial communication between a board and an external device. While developing a project, the tool helps you to perform *read* and *write* operations via UART protocol.

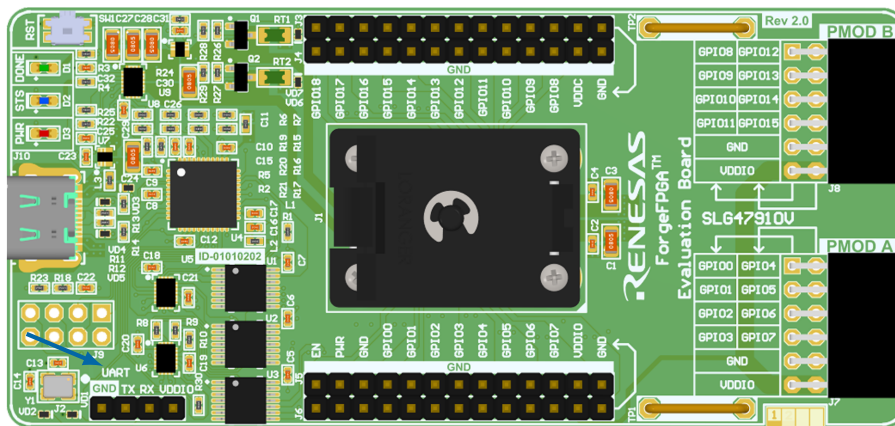

The UART port on the ForgeFPGA Evaluation Board

To start working with the terminal, make sure you select the platform supporting this feature. Open



the *UART Terminal* tool at the top toolbar.

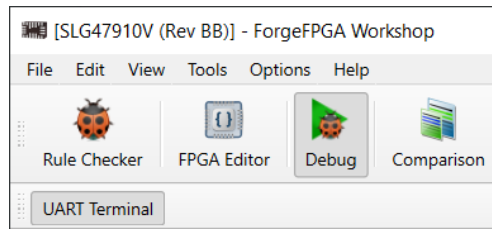

**UART Terminal on the toolbar**

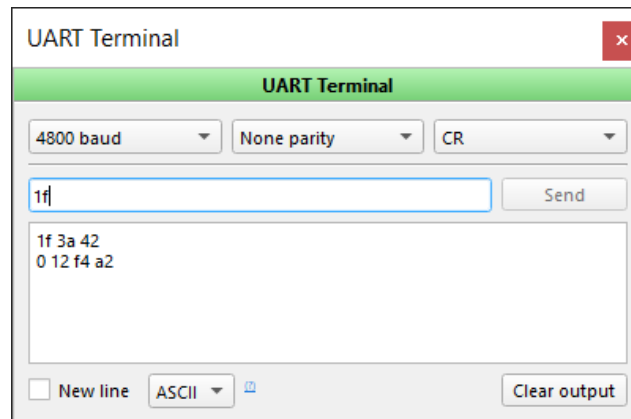

**UART Terminal window**

The *UART Terminal* key features are as follows:

- ▶ *Baud rate* — select the baud rate from the list for *read* and *write* operations
- ▶ *Parity control* — choose whether the parity control bit is used and how
- ▶ *Line ending* — set which character is used as a new line character: *No line ending*, *New Line (NL)*, *Carriage Return (CR)* or both *New Line* and *Carriage Return*. This option is available in ASCII mode only
- ▶ *New line* — add a new line after each byte sent if set; otherwise, send the whole message at once
- ▶ *Data Format* — select the data format: ASCII or hex. For the hex format, the input case is independent, numbers are separated by a space

The input field allows copy/paste operations. The output field allows copying the received data.

### 2.2.13 DAC Tool

The *DAC Tool* allows you to configure the voltage level on special analog output socket pins.

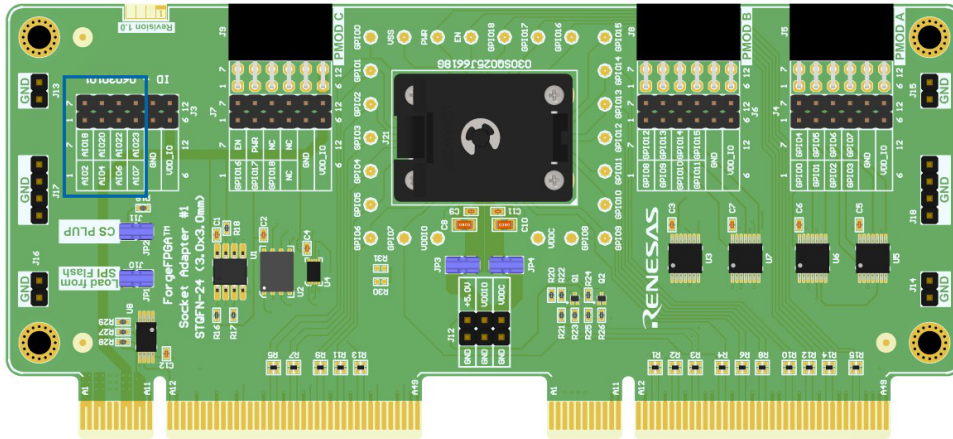

### Analog I/O pins on the ForgeFPGA socket adapter

Start by selecting the appropriate development platform and opening the *DAC Tool* from the toolbar.

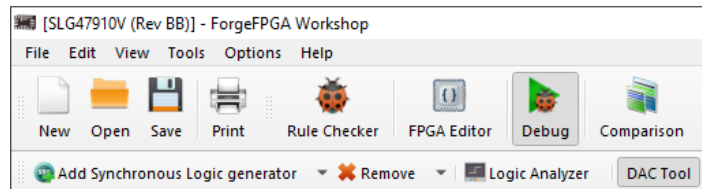

### DAC Tool on the toolbar

All the analog I/O pins are disabled by default. Use an *Analog I/O n* button to enable a respective output pin and use a spin box at the right to set a desired voltage level on it.

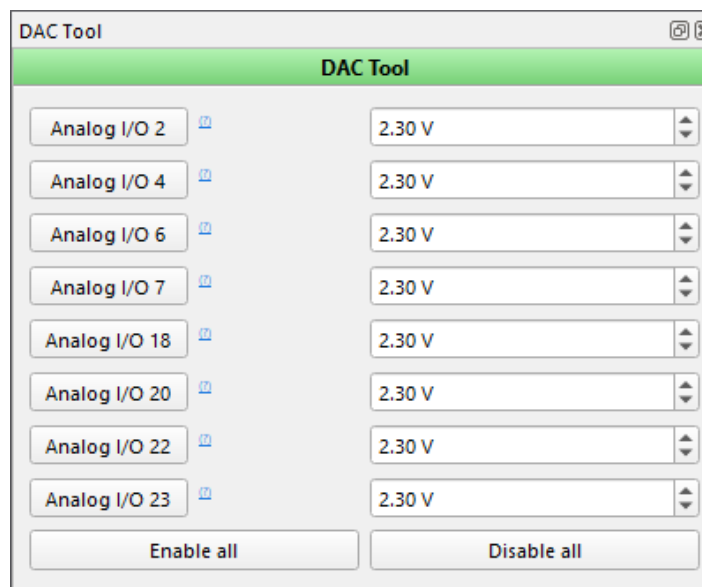

### DAC Tool window

**Note:** Setting a voltage level on analog I/O pins is enabled only if *Emulation* or *Test Mode* is activated.

## 2.2.14 OTP Programmer

*OTP Programmer* allows you to read *OTP (One-Time Programmable) memory* from a chip, make changes, and program the new data. The tool shows differences and conflicts between the programmed chip project and current project data.

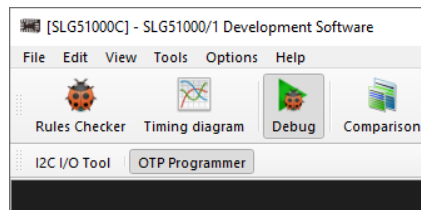

**OTP Programmer**

To reach the *OTP Programmer* tool, click on *Debug* button and select suitable development platform.

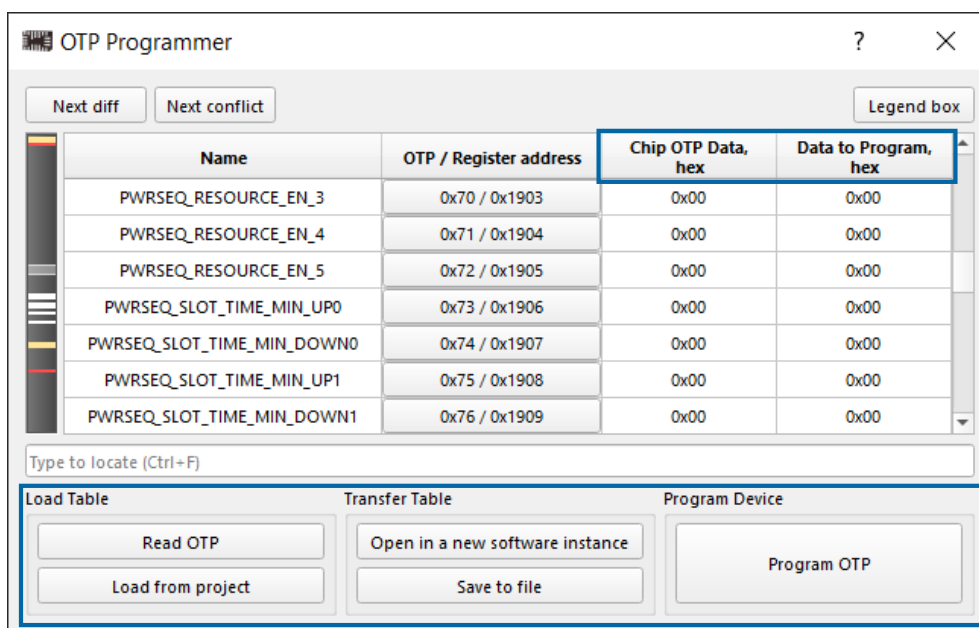

**OTP Programmer**

Before you start working with *OTP Programmer*, check whether the chip is detected (platform and chip info should appear in the *Info details* on the *Debugging Controls* panel).

The tool contains the following controls:

- *Read OTP* — read the data from the chip and load/set it into the *Chip OTP Data* column
- *Load from project* — load the data from the current project into the *Data to Program* column
- *Open in a new software instance* — open the *Data to Program* in the new software instance
- *Save to file* — save the *Data to Program* into a text file
- *Program OTP* — program the chip with the *Data to Program* (**Note:** It is possible to program bits from 0 to 1, but not vice versa)

Open in a new software instance, Save to file, and Program OTP buttons become available after using Read OTP or Load from project buttons.

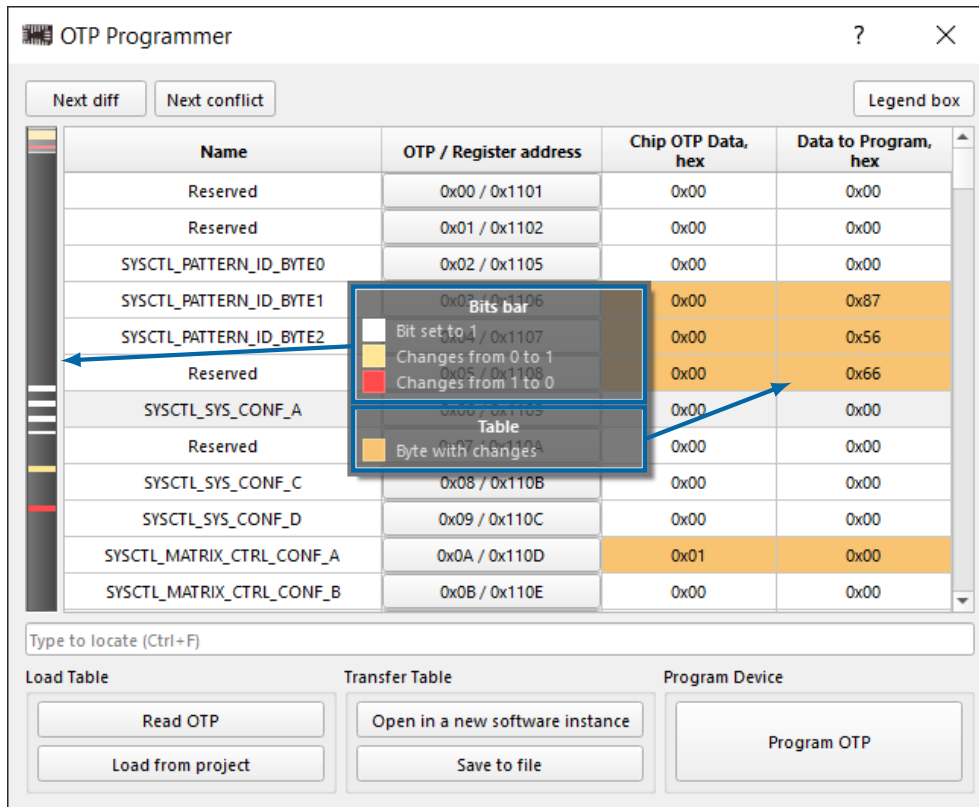

### Legend Box

- *Legend Box* — shows the color scheme of Bits changes in *Bits bar*
- *Next diff* — switch focus to the next *Byte with changes*
- *Next Conflict* — switch focus to the next *Byte with changes* in which the value was changed from 1 to 0
- *Search field* — find a required byte or register

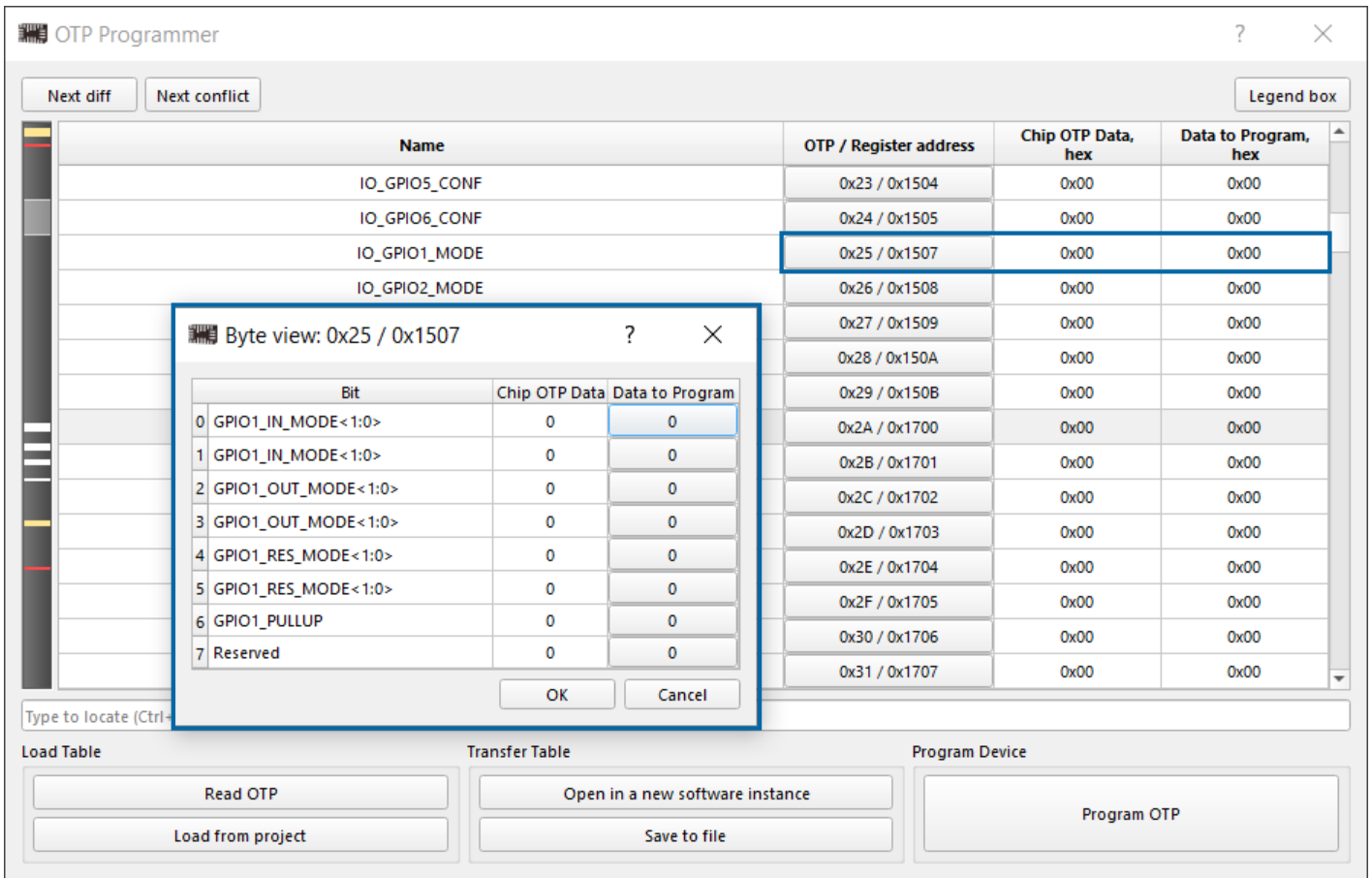

### Byte view

You can edit *Data to Program* by double-clicking a cell in the *Data to Program* column or open the *Byte view window* by clicking the required cell in the *OTP/Register address* column.

## 2.2.15 Voltage Monitor

The *Voltage Monitor* tool helps you to measure the voltage on the ADC channels. The tool appears on the toolbar after you click *Debug* and select the appropriate development platform.

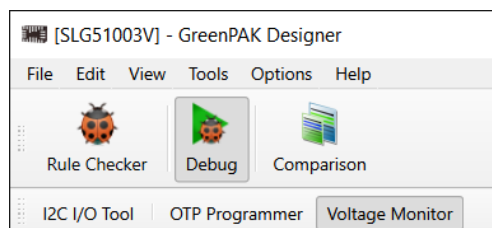

### Voltage Monitor on the toolbar

Voltage Monitor	
<input type="button" value="Refresh"/> <input checked="" type="checkbox"/> Auto Refresh           Last Update: 18:08:12	
Channel	Value
VDD	3.818
VOUT1	2.862
VIN2	4.996
VOUT2	3.326
VIN3	1.503
VOUT3	1.182

**Voltage Monitor tool**

Once the platform is connected, the controls on the tool become active, and you can update the table data. Use the corresponding controls for table refresh or auto-refresh.

The tool also contains the *Channel/Value* table.

- ▶ *Channel* — channel types with VIN and VOUT relations
- ▶ *Value* — value measured in volts. The accuracy of measurement is three decimal places

## 2.2.16 Power Monitor

The *Power Monitor* tool is designed to measure the chip voltage and current for power consumption calculation. Find the tool on the toolbar after you click *Debug* and select the appropriate development platform.

**Note:** To activate the tool, *Emulation* or *Test Mode* is required.

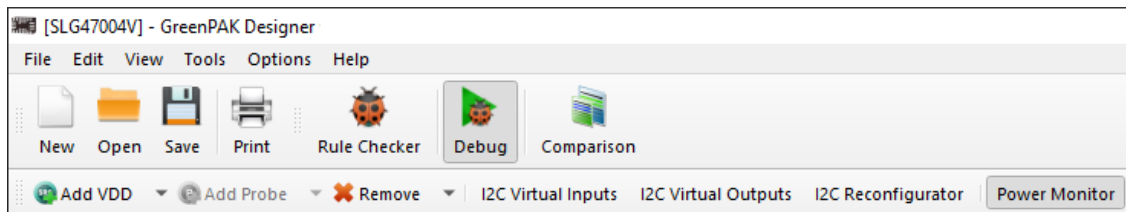

**Power Monitor on the toolbar**

To refresh or auto-refresh the data use the corresponding controls. For more tool details click the

information button.

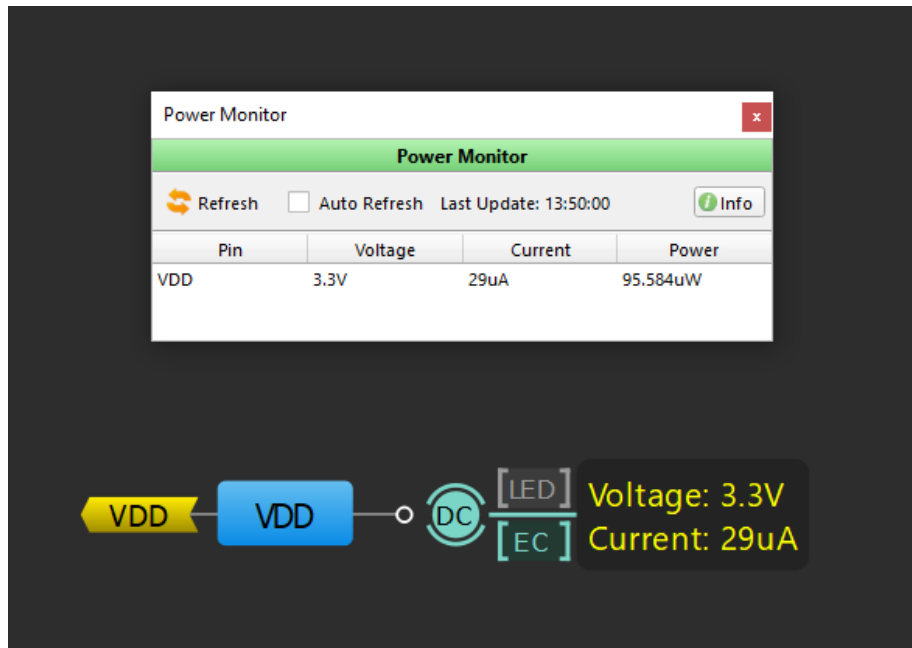

**Power Monitor with work area label**

Work area labels are a helpful reference for displaying voltage and current values. Once *Emulation* or *Test mode* is activated and the data is refreshed, these labels light up, duplicating values from the *Power Monitor* window for a convenient design process.

**Notes:**

- For the most precise adjustment of the circuit's current consumption, set all hardware sources connected to the chip outputs to *High-Z* and those connected to inputs to *Pull-Down*
- For *External device*, if *External VDD* is selected, *Power Monitor* does not provide calculations for power consumption, since current cannot be measured by the tool under this condition

## 2.3 Configuration tools

### 2.3.1 Asynchronous State Machine Editor

*GreenPAK* family devices featuring the *Asynchronous State Machine (ASM)* macrocell allows you to develop personalized state machine designs. You can establish state definitions, define permissible state transitions, and specify the signals responsible for initiating each state transition. Moreover, you can link this macrocell to various I/O Pins and other internal *GreenPAK* components to activate inputs for state transitions. Outputs from the macrocell can be conveniently directed to other internal macrocells or I/O Pins as needed. *ASM Editor* allows configuring the ASM component using the state diagram and setting the output configuration for the ASM Output macrocell.

To open the ASM Editor, click the *ASM Editor* button on the toolbar or double-click the ASM component.

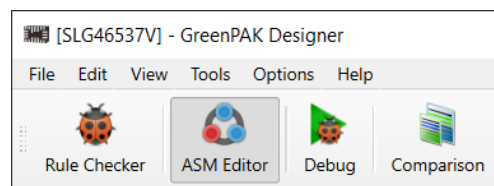

**ASM Editor on the toolbar**

#### ASM Editor's interface

You can view and set a state's properties in the *Properties* panel.

The *RAM* properties panel at the right contains the *Connection Matrix Output RAM*. This feature establishes the relationship between controlled outputs and specific states. Additionally, certain part numbers might have their output pin behavior regulated by these states. This behavior is indicated in the *GPOs Output RAM* table.



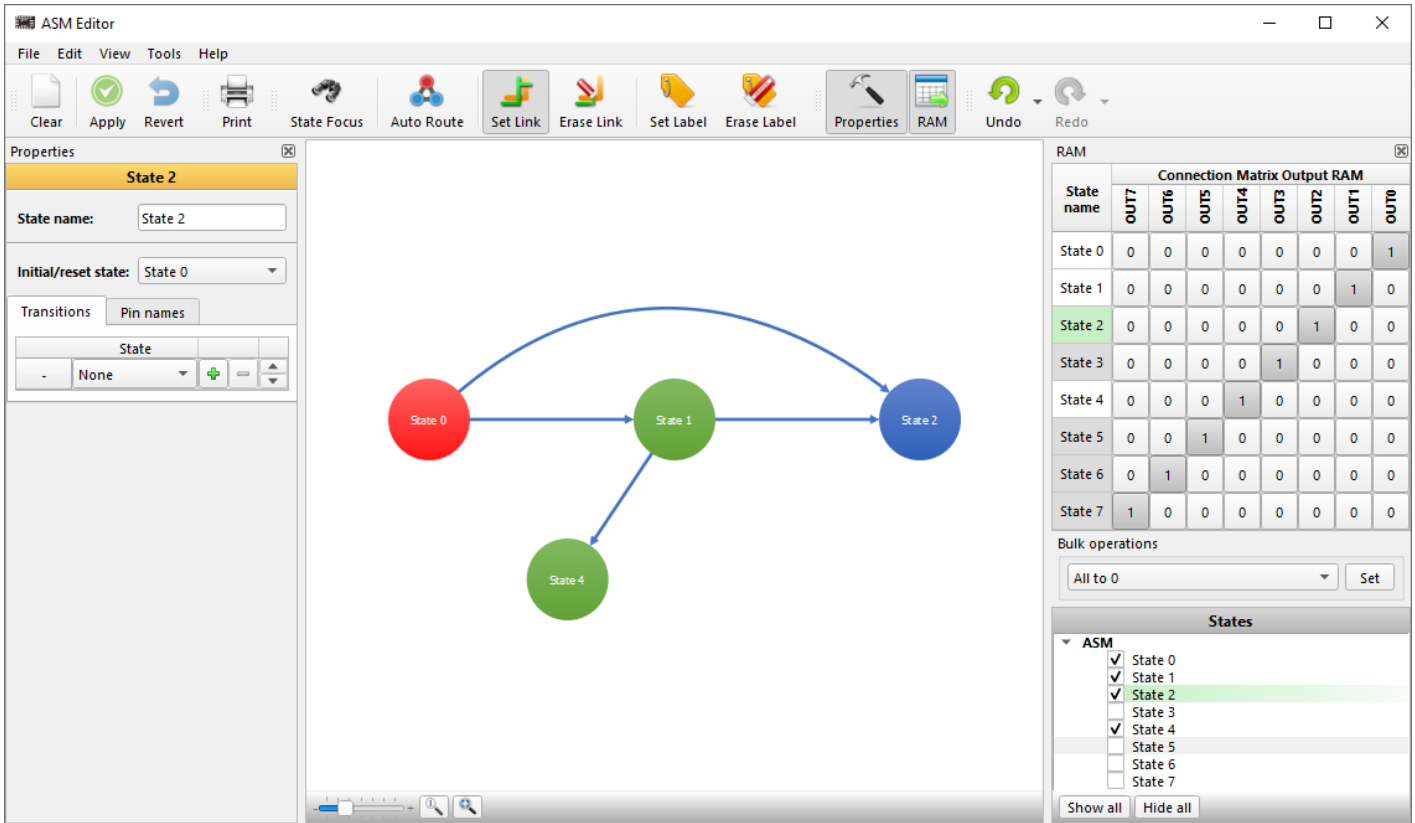





### Setting a state transition

Bulk operations allow applying a selected operation (*All to 0*, *All to 1*, *Invert*, and resetting to *Default*) to the whole table.

You can show or hide states by toggling the corresponding checkboxes within the States section located in the lower right area of the *RAM* properties panel.

The *main area* of the ASM editor depicts states. The color of a state changes according to the state's interaction options.

-  Regular state    regular state
-  Selected state    selected state
-  Initial state    initial (reset) state
-  Limit reached    state transitions limit reached

## Configuring States

If states haven't been established, the *ASM Editor* will display two detached states. These states are illustrated as circles. To relocate a state, use the left mouse button to drag its inner circle. **Note:** dragging the outer circle will not produce any changes. To establish a connection click the outer ring of one state and then click on the ring of another state.

For some chips, a state may be directed to itself by selecting the state's outside ring on both the first and second click. The number of states a particular state can transition to is unrestricted; it can transition to all the utilized states or none at all.

To rename a state, double-click on the inside of the state circle or select the state to access the *State name* setting from the *Properties* docker at the left.

*Transitions* can be adjusted to best fit your scheme. Drag the link to change its shape. Select the *Edit path* mode from a connection's context menu if you need more tweaking. **Note:** A link's shape is updated automatically and the manual adjustments get discarded every time a state is repositioned.

You can let the software reorder the states and transitions by clicking *Auto Route* on the toolbar. You can also add a label to a transition. To do that, click *Set label* at the top menu, or click the mouse right button on an existing transition and select *Set label*.

You can also focus on the states by clicking the *State focus* button on the toolbar.

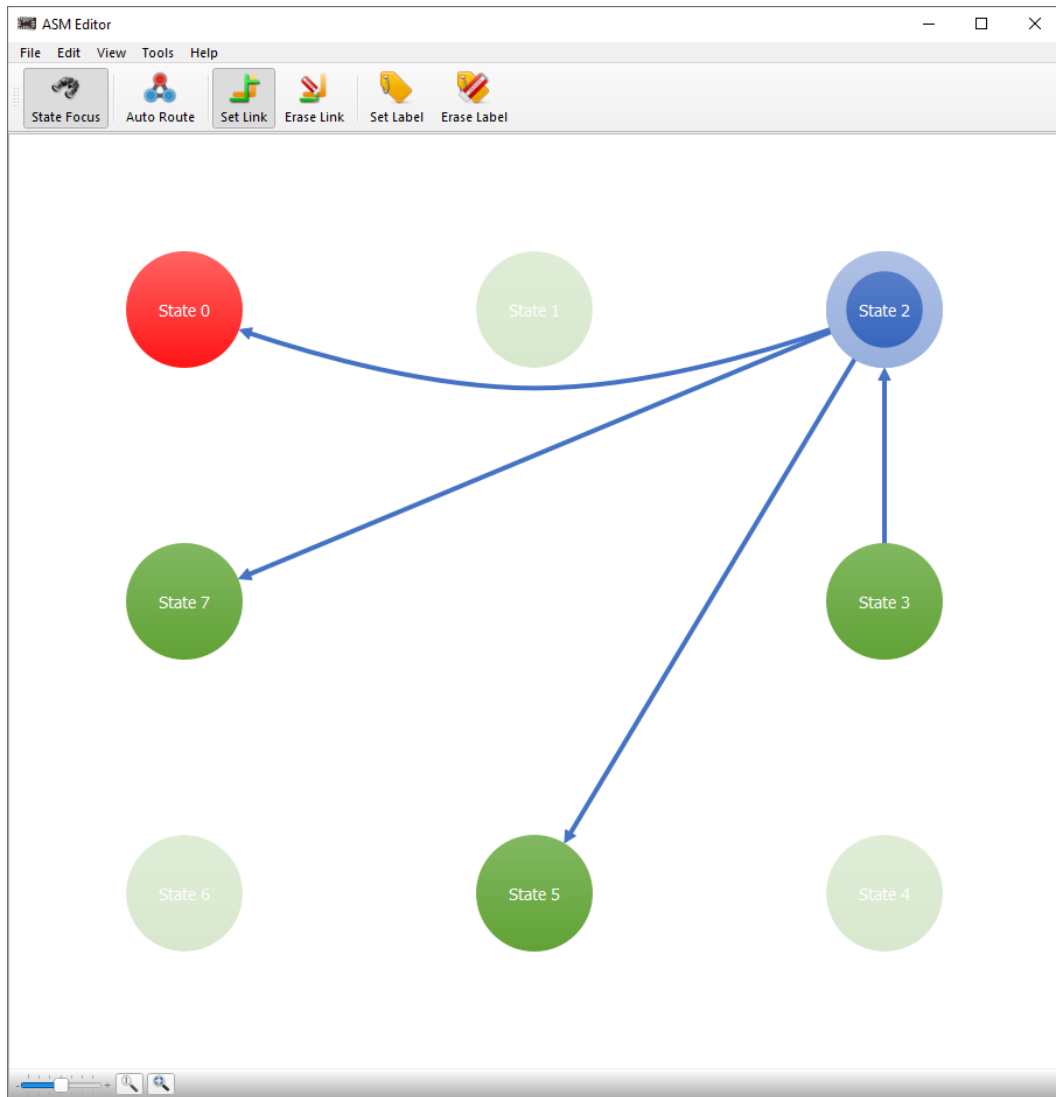

**State focus mode**

In order to set an *ASM* configuration to the *NVM*, apply it by clicking *Apply* on the toolbar. To return to the latest saved state of the *ASM* click *Revert*.

The context menu of a state includes:

- *Edit name* — set state's name
- *Initial state* — set the current state as the initial
- *Hide* — hides the current state

You can configure a state's properties in the *Properties* panel at the left. The available tabs are:

- *Transitions* — lists of the states to which the current state transitions. Allows adding a new transition by selecting another state from the list.
- *Pin names* — this tab's data is common for all states. It lists pin names set the current state as

the initial

- ▶ *RE (Rising Edge)* — lists the states the current state transitions to and apply *Rising Edge* to the transition, otherwise ASM will be level sensitive.

### 2.3.2 EPG Waveform Editor

The *Extended Pattern Generator (EPG)* is a component featuring up to 8 outputs. Each can be individually configured using up to a 92-bit large logic pattern. It retrieves data from non-volatile memory (*NVM*) and delivers it to the outputs bit by bit on each rising edge of the *CLK input* signal.

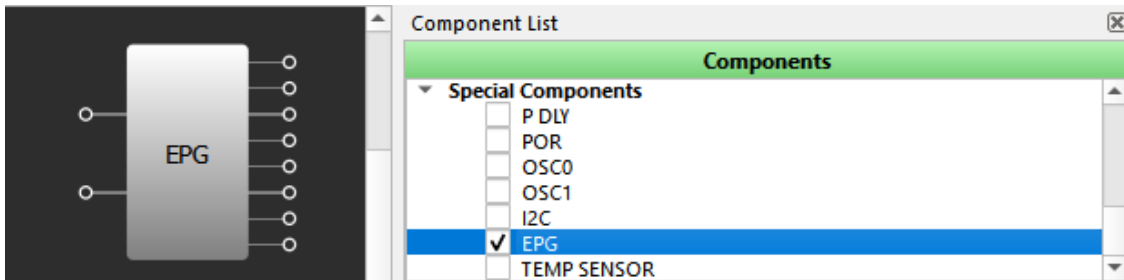

**Extended Pattern Generator**

You can configure the *Extended Pattern Generator* in the *EPG Waveforms Editor*. This tool allows you to choose from the available predefined generators, including *SPI*, *I2C*, *PWM*, or *Manual*, and assign the output accordingly. Each of these generators offers a range of adjustable settings, making it more

convenient for you to create desired patterns.

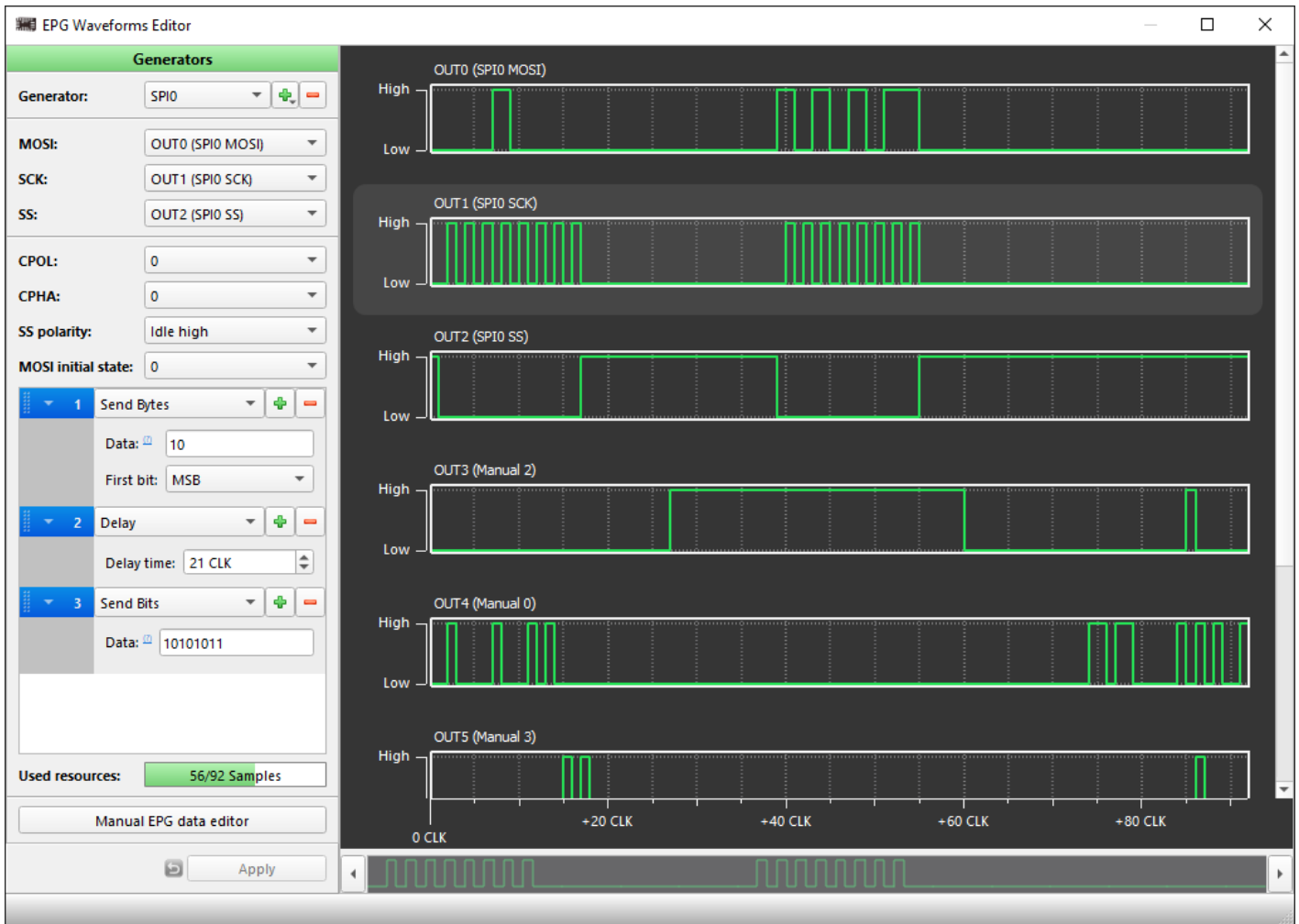

**EPG Waveforms Editor**

Within the *EPG Waveforms Editor*, you can also find a *resource meter* that visually represents the number of bits used in the pattern. This feature provides transparent view of the memory and resources allocated to the present pattern.

The *SPI generator* allows you to select and configure the output pin using the *command editor*.

The screenshot shows the 'Generators' window for the SPI generator. It features a green header and a light gray background. The 'Generator:' dropdown is set to 'SPI0'. Below it are dropdowns for 'MOSI:' (OUT0 (SPI0 MOSI)), 'SCK:' (OUT1 (SPI0 SCK)), and 'SS:' (OUT2 (SPI0 SS)). Further down are dropdowns for 'CPOL:' (0), 'CPHA:' (0), 'SS polarity:' (Idle high), and 'MOSI initial state:' (0). The command editor consists of three items: 1. 'Send Bytes' with 'Data:' set to '10' and 'First bit:' set to 'MSB'. 2. 'Delay' with 'Delay time:' set to '21 CLK'. 3. 'Send Bits' with 'Data:' set to '10101011'. At the bottom, the 'SPI0 resources:' meter shows '56/92 Samples' in a green bar, with a 'Clear' button. Below the meter is a 'Manual EPG data editor' button and an 'Apply' button.

**SPI generator command editor and resource meter**

The *I2C generator* allows you to select the *SDA* and *SCL* output pins and define commands using the *command editor*. Within the editor, you can select basic commands from a menu, such as *Start*, *Stop*, and *GreenPAK* access operations like *Read/Write*. The *I2C generator* has an *S* button that allows you to

break down complex *GreenPAK* access commands into a series of basic commands.

The screenshot shows the 'Generators' window for an I2C generator. The 'Generator' dropdown is set to 'I2C0'. Below it, 'SDA' is set to 'OUT0 (I2C0 SDA)' and 'SCL' is set to 'OUT1 (I2C0 SCL)'. A sequence of seven commands is listed:

Step	Command	Start	Stop
1	Start	S	+
2	Control Byte	S	+
Operation: Write Slave address: 0x0 (hex) Result value: 0/0x00/0b00000000			
3	Slave Ack	S	+
4	Data	S	+
Value: 0x0 (hex)			
5	Slave Ack	S	+
6	Data	S	+
Value: 0x0 (hex)			
7	Stop	S	+

At the bottom, 'I2C0 resources' is shown as '58/92 Samples' with a 'Clear' button. A 'Manual EPG data editor' button and an 'Apply' button are also present.

**I2C generator command editor and resources meter**

The *PWM generator* configures the *output pin*, *period duration*, *high level duration*, and *phase shift*.

The screenshot shows the 'Generators' window for a PWM generator. The 'Generator' dropdown is set to 'PWM0'. The 'Output' is set to 'OUT7 (PWM0)'. The configuration parameters are:

- Period duration: 92 CLK
- High level duration: 52 CLK
- Duty cycle: 56.52 %
- Phase shift: 27 CLK

At the bottom, there is a 'Manual EPG data editor' button and an 'Apply' button.

**PWM generator options**

The *Manual* generator allows configuring the bit values.

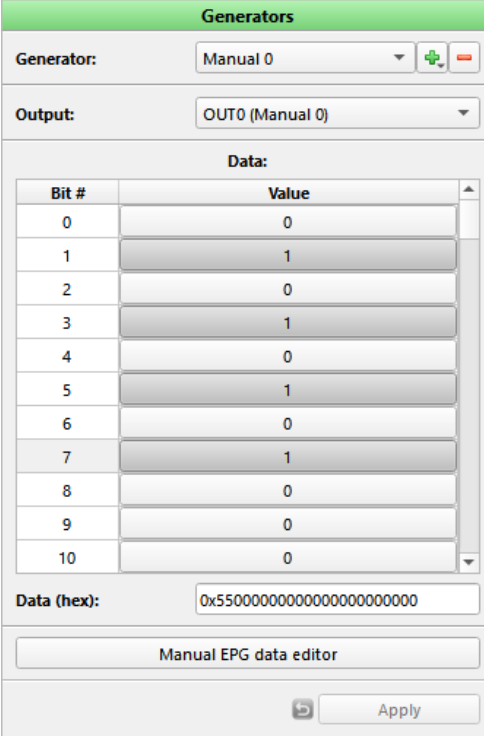

The screenshot shows a software interface titled "Generators". It includes a dropdown menu for "Generator" set to "Manual 0", an "Output" dropdown set to "OUT0 (Manual 0)", and a "Data" section with a table of bit values. Below the table is a "Data (hex)" field containing "0x55000000000000000000000000000000" and a "Manual EPG data editor" button. An "Apply" button is at the bottom right.

Bit #	Value
0	0
1	1
2	0
3	1
4	0
5	1
6	0
7	1
8	0
9	0
10	0

**Manual generator options**

When the system is powered up, the behavior of the *EPG* varies depending on the signal that received at the *nReset* input. In particular, if the *nReset* input is in an active *LOW* state, the *EPG* will display the initial value at the output. Conversely, if the *nReset* input is active *HIGH*, the *EPG* will display user-defined patterns at the output. This feature enables you to customize the output of the *EPG* to specific needs. Moreover, *EPG* can work continuously when *CLK* is being applied in *Overflow* mode or keep at the last byte in *Stop at Boundary* mode.

### 2.3.3 Timing Diagram

*State control timing diagram* is a tool, which allows managing the *Power sequencer* block configuration. The *Power sequencer* controls the *power-up* and *power-down* timings for the six resource enable outputs, which feed the matrix interconnect. The timing sequence is divided into six slots, which are periods between the events. You can set the minimum and maximum duration per each slot. The sequence is initiated with the *trigger-up* and *trigger-down* control signals from the matrix interconnect. The *Power*



sequencer and, therefore, *Timing diagram* tool are available e.g. SLG51000/1 and SLG51002.

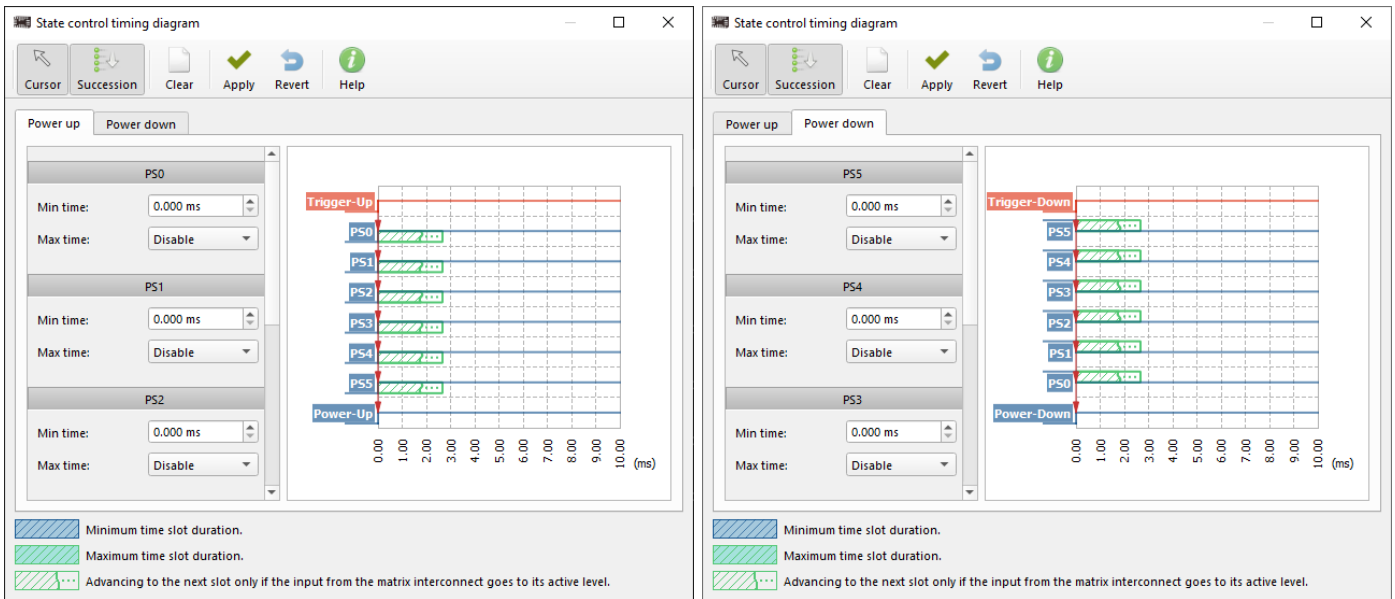

**Timing diagram**

The slot view depends on the Min. time and Max. time settings. You can see the legend at the bottom of the *Timing diagram* window.

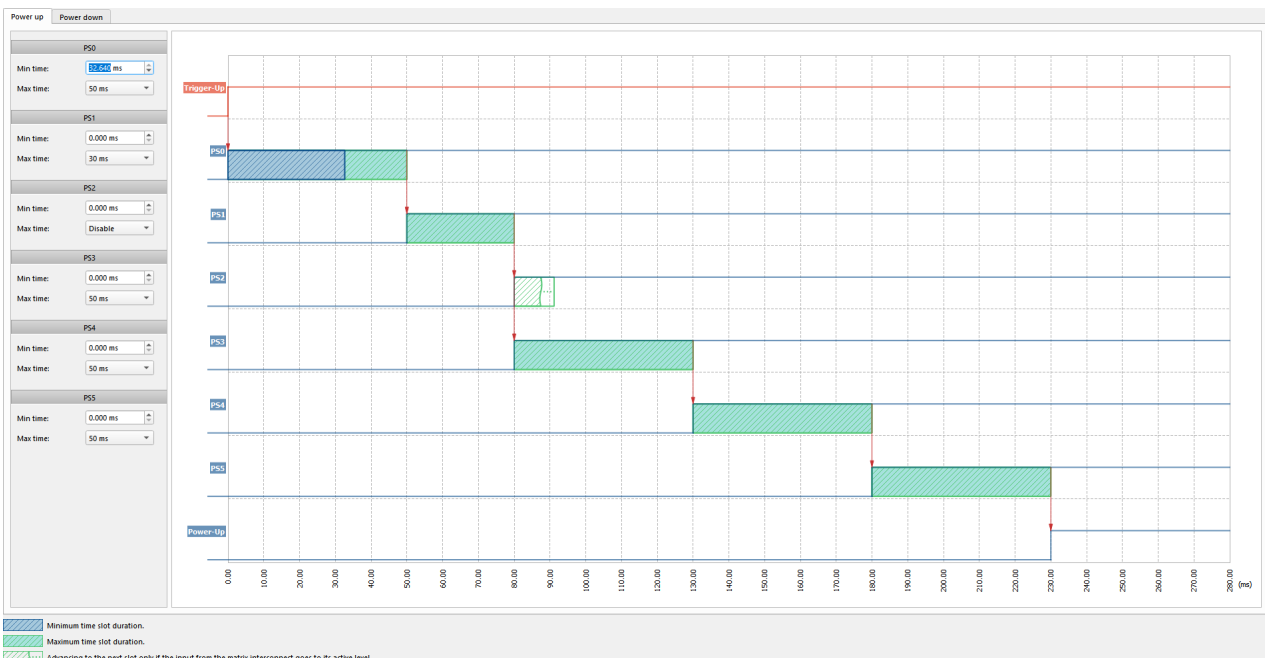

**Slot view examples**

Use the toolbar controls to work with the tool.

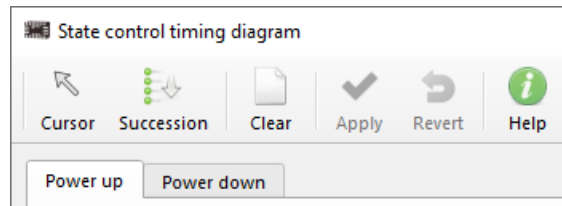

Timing diagram options

### 2.3.4 Memory Table Editor

*Memory Table Editor* allows you to configure the Memory table macrocell (make sure you select the ROM mode on the macrocell's *Properties* panel). To open the tool, click the *Memory Table Editor* button on the toolbar or double-click the corresponding component on the work area.

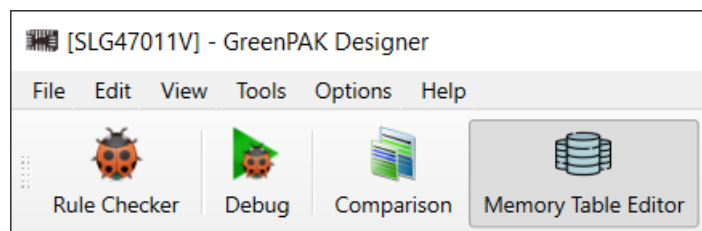

Memory Table Editor on the toolbar

The *Memory Table Editor* window visualizes the output data of the Width Converter (WC) in graphical format (WC provides data from Memory Table to the connection matrix).

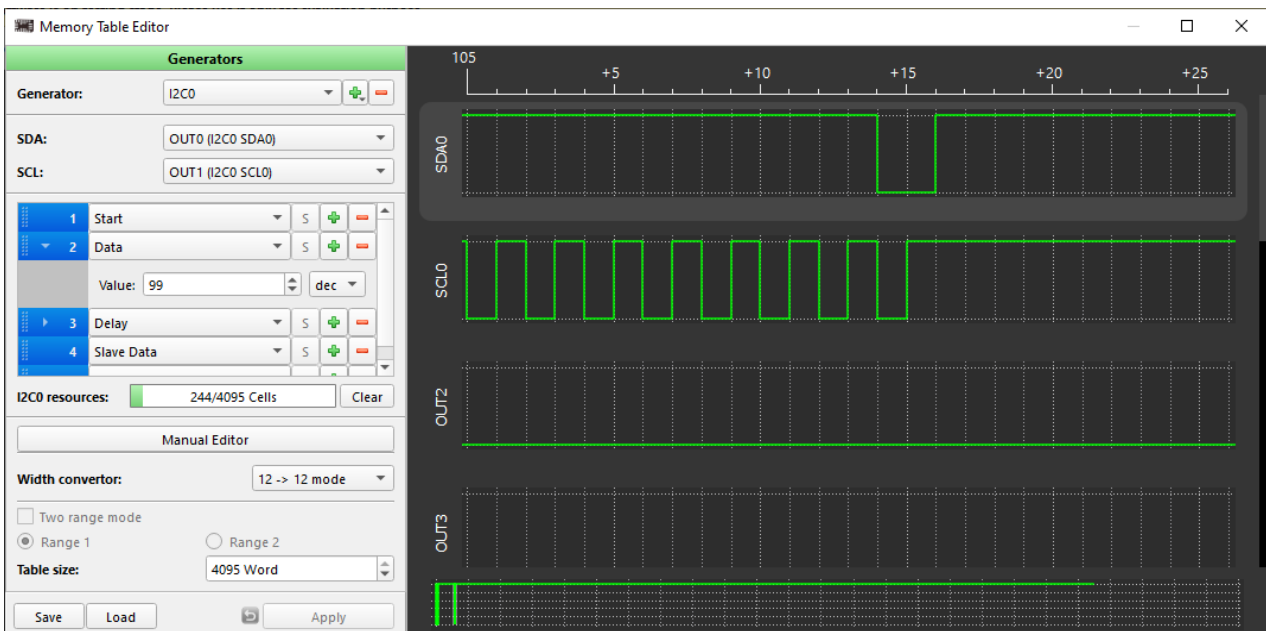

Memory Table Editor window

The tool provides you with the following possibilities:

- Add the generator type. For *I2C* and *SPI* use the available generator-specific settings, e.g. specify which Width Converter output corresponds to which generator signal. Upon selecting *Manual* generator the word (digit) is represented in binary format, while *Signal* represents the word in decimal format.

The x-axis on the graph is the word sequence number, a memory cell (*Word index*). The y-axis is a word saved in the memory cell (*Word decimal*).

Use [Manual Editor](#) to customize the data (read more below)

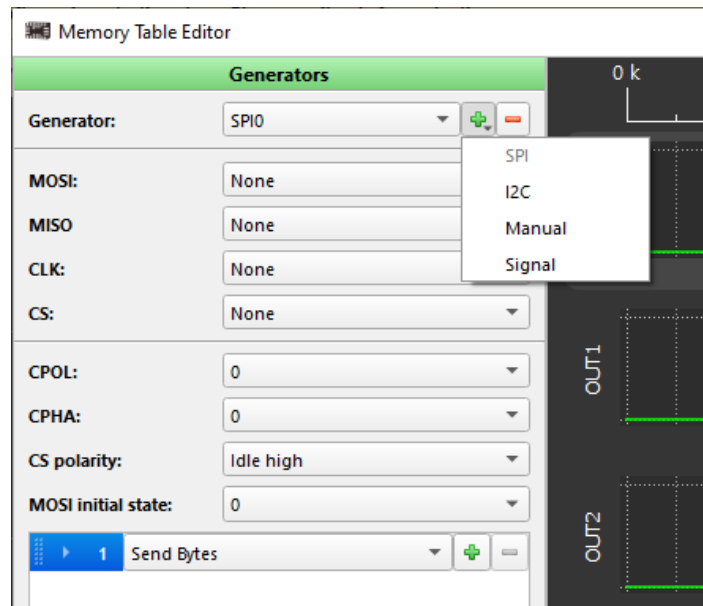

**Generator configuration**

**Note:** If a generator is locked and cannot be added, try to change the [Width converter mode](#).

- Check the *Resources* bar, indicating the number of available cells. The number of cells, as well as the displayed output signals, depends on the selected *Width converter* mode, which are:
  - 12 → 12 (12-bit parallel output)
  - 12 → 4 (12-bit word to three 4-bit words)
  - 12 → 2 (12-bit word to six 2-bit words)
  - 12 → 1 (12-bit word to serial bit stream)

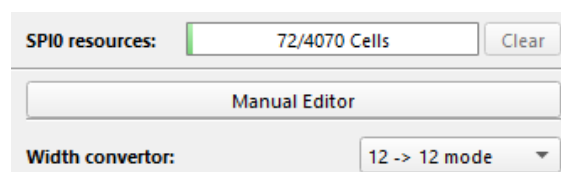

**Resources/Width converter mode**

- *Manual Editor* allows you to modify the macrocell's bit values of the specific registers, and consists of three main parts:
  - Navigation controls — enter the bit number and click *Go to bit* button to jump to the desired bit
  - Registers value configuration — configure the registers by setting values in binary, decimal, or hexadecimal format (bits set to 1 are indicated with white highlight on the sidebar)
  - Bottom controls — *Import/Export* or *Clear* the data

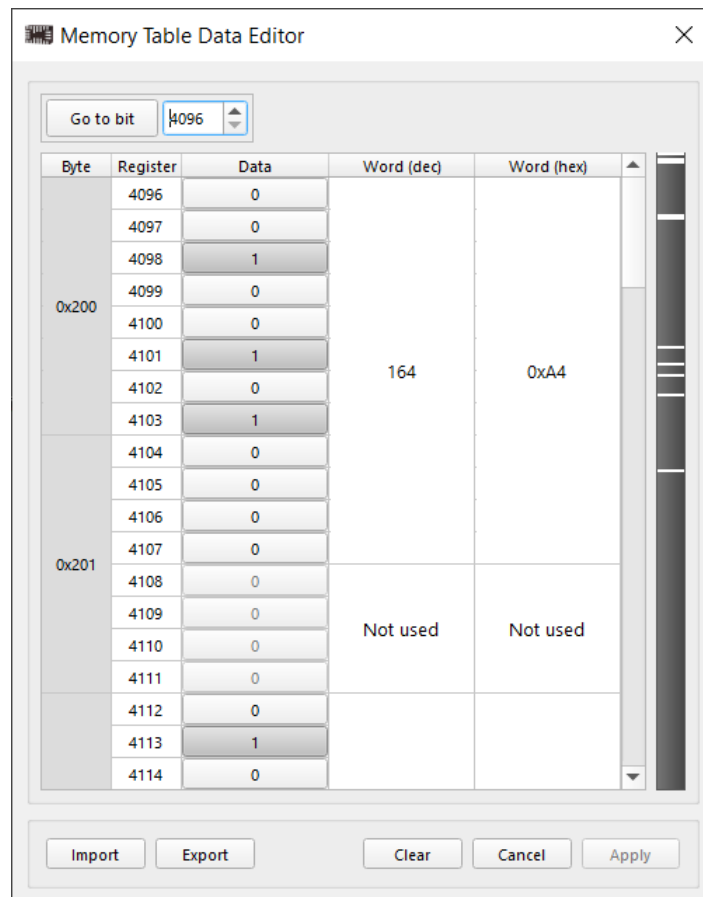

**Memory Table Data Editor**

- The additional settings provide flexibility in table usage defining the access to the memory cells. To activate the *Two range mode* checkbox, the following conditions should be met:
  - Memory Control Counter (MCC): *Range mode select* = Two ranges; *Initial CNT data value* != 0 (make configurations on MCC's *Properties* panel)
  - **Generator** is added



**Additional settings**

- ▶ Save/Load the file with configurations using the corresponding bottom controls

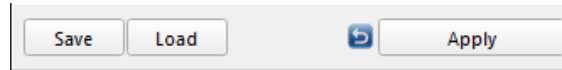

### Save/Load controls

See some additional plot controls:

- ▶ Zoom the graphs with `Ctrl + mouse wheel`. Reset scale via the context menu
- ▶ Enable legend for each plot via the context menu

## 2.4 Software simulation tool

The *Software Simulation* mode enables electronic circuit simulation. It uses mathematical models to replicate the behavior of the chip macrocells and the external components. To start *Software Simulation*, click *Debug* on the toolbar and select the tool in the *Development Platform Selector*. Refer to the *Hub* window → *Development* tab → *Details* to check the simulation support availability for a certain Part Number.

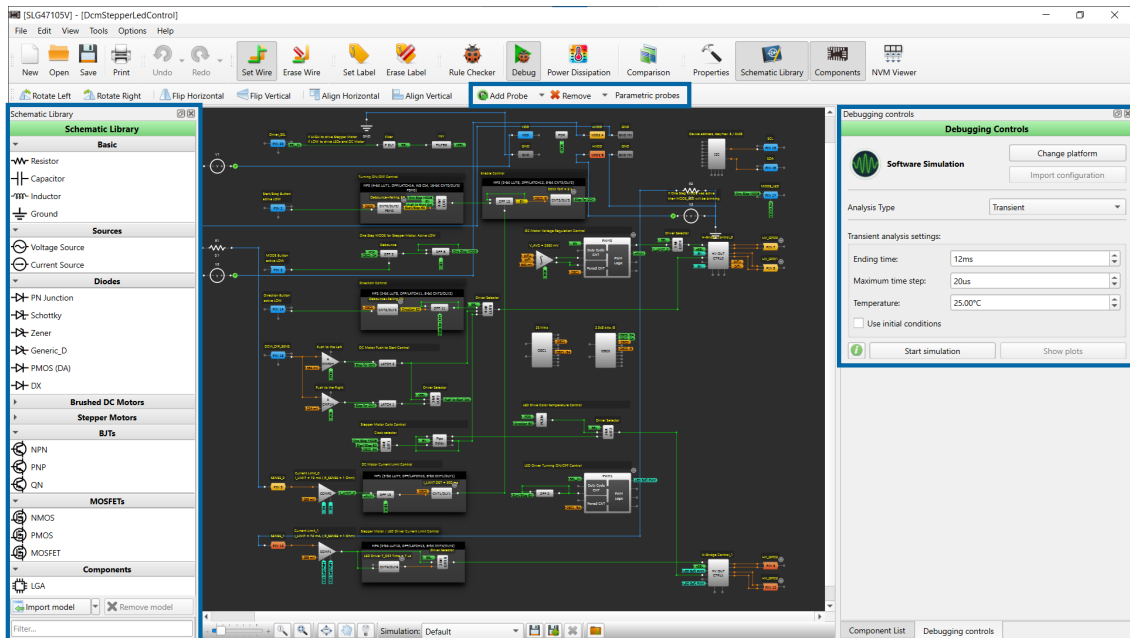

Software Simulation Tools

Before starting an analysis, you can use the external components from *Schematic Library* and add probes to configure the simulation environment parameters.

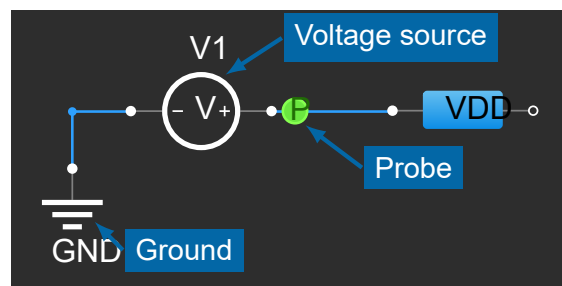

Basic Simulation Tools

### 2.4.1 Schematic Library

The *Schematic Library* is a repository of the **external components** you can apply to the design. External components are not a part of the chip; however, adding and configuring them allows you to simulate the system's behavior.

You can also add a custom component to the *Schematic Library* list by using the *Import model/subcircuit* feature. See the corresponding buttons on the *Schematic Library* panel (read more in section 2.4.3

Working with models and subcircuits). Find imported models and subcircuits in the *Schematic Library* in the designated location.

The image shows a screenshot of the 'Schematic Library' dialog box. The dialog is titled 'Schematic Library' and has a close button (X) in the top right corner. It is organized into several sections:

- Basic:** Contains Resistor, Capacitor, Inductor, and Ground.
- Sources:** Contains Diodes.
- Diodes:** Contains PN Junction, Schottky, Zener, Generic\_D, PMOS (DA), and DX. A blue box highlights this section with an arrow pointing to a callout box that says 'Imported and user-defined models'.
- Brushed DC Motors:** Contains Generic Brushed DC Motor, Portescap 17N78-210E.1, Crouzet 827200, Maxon DCX 6M, Maxon DCX 14L, and Maxon RE25 118743. A blue box highlights this section with an arrow pointing to the same callout box.
- Stepper Motors:** (Section header)
- BJTs:** (Section header)
- MOSFETs:** Contains NMOS, PMOS, and MOSFET.
- Components:** Contains LGA. A blue box highlights this section with an arrow pointing to a callout box that says 'Imported subcircuits'.

At the bottom of the dialog, there are two buttons: 'Import subckt' and 'Remove model'. A blue box highlights these buttons with an arrow pointing to a callout box that says 'Model/Subcircuit adding and removal'. Below the buttons is a 'Filter...' input field.

**Schematic Library**

Unlike the default external components, an imported model/subcircuit can be deleted from the library. Click the component and then *Remove model* below.

## 2.4.2 External components

See the list of external components on the [Schematic Library](#) panel. Click the component and then the work area to add it (discard adding with a right-click). Once added, find the *Copy component(s)/Paste component(s)* options in the desired component's/work area context menu (or use Ctrl + C / Ctrl + V shortcuts).

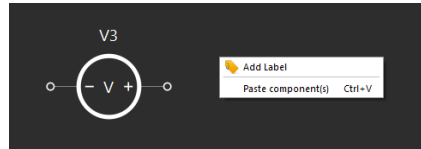

**Paste external components**

Double-click a component on the work area to open its *Properties* panel. Click *Configure* on the panel for more advanced settings.

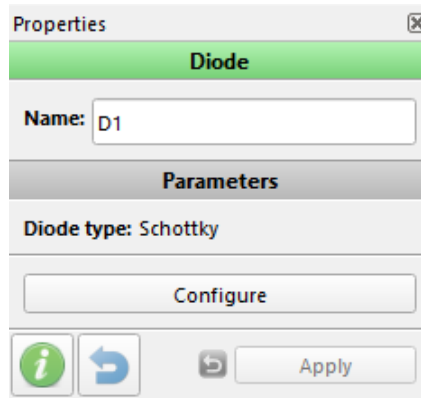

**Configuring basic parameters**

Connect the external components to the external I/O macrocell pins or to the other external component's pins using the *Set Wire* tool. Upon setting a connection, the available pins become highlighted. By default, voltage source(s) and GND are added to specific pins.

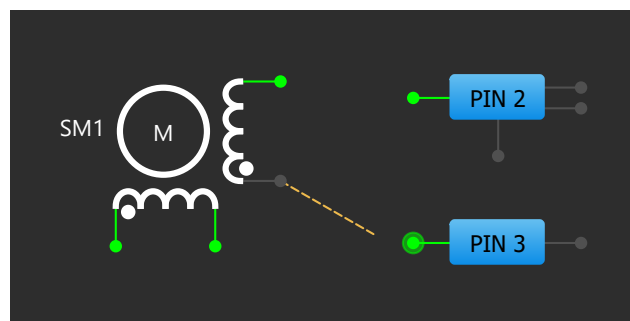

**Adding wire to an external component**

Here, you can see the external connection type (all connection types are described in the section



## 2.1.5 Connections).

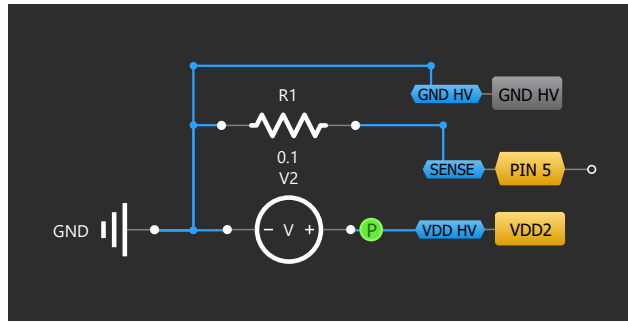

External connections

## 2.4.3 Working with models and subcircuits

You can import third-party *SPICE* models and subcircuits to the project. *Import model/subcircuit* opens the *Import* window, where you can insert a *SPICE* simulation model/subcircuit, fill in additional information, and add it to the library.

The dialog validates a *SPICE* syntax of a model/subcircuit. Only one model can be imported at a time.

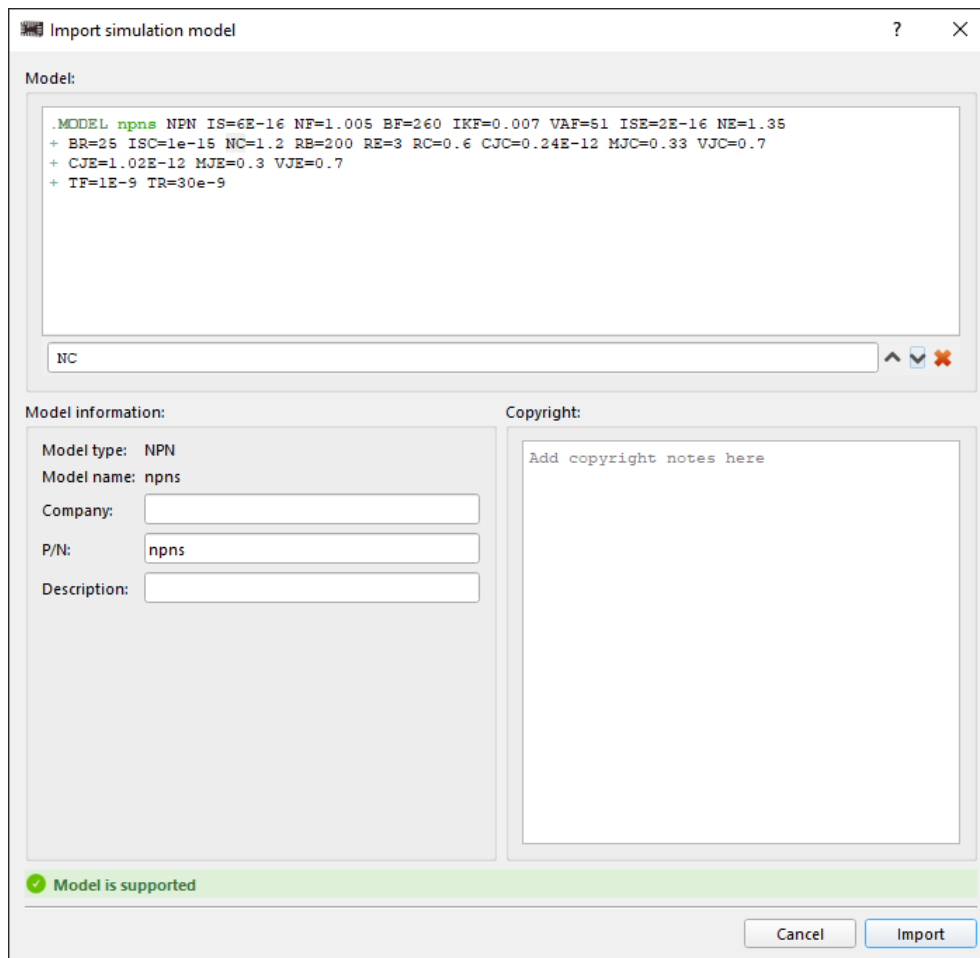

Import simulation model window

Unlike models, you can import multiple subcircuits and select one of them as main:

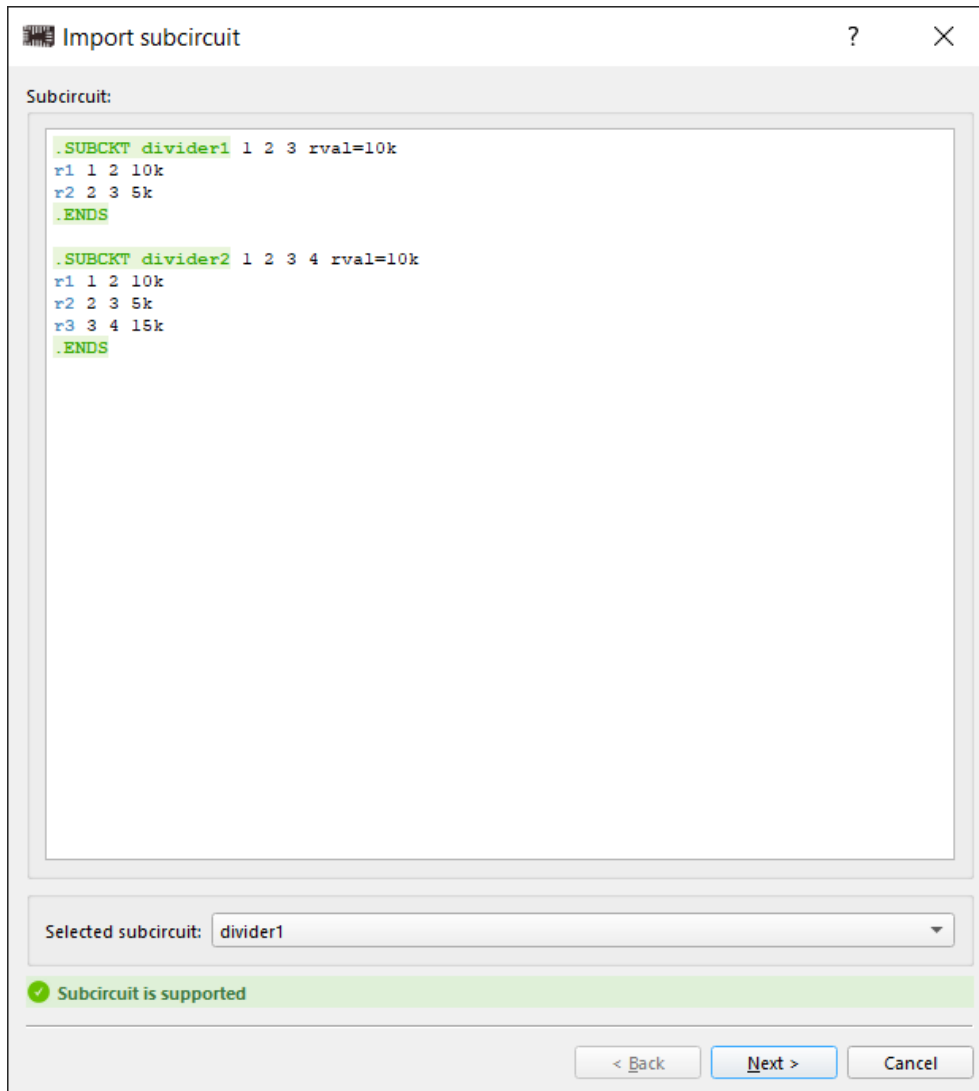

**Importing a model containing multiple subcircuits**

Model/Subcircuit parameters can be edited via the *Properties* dialog window. Double-click a component in the work area or click *Configure* in the *Properties* panel. The *Properties* window allows

configuring the external component's parameters and editing the model/subcircuit.

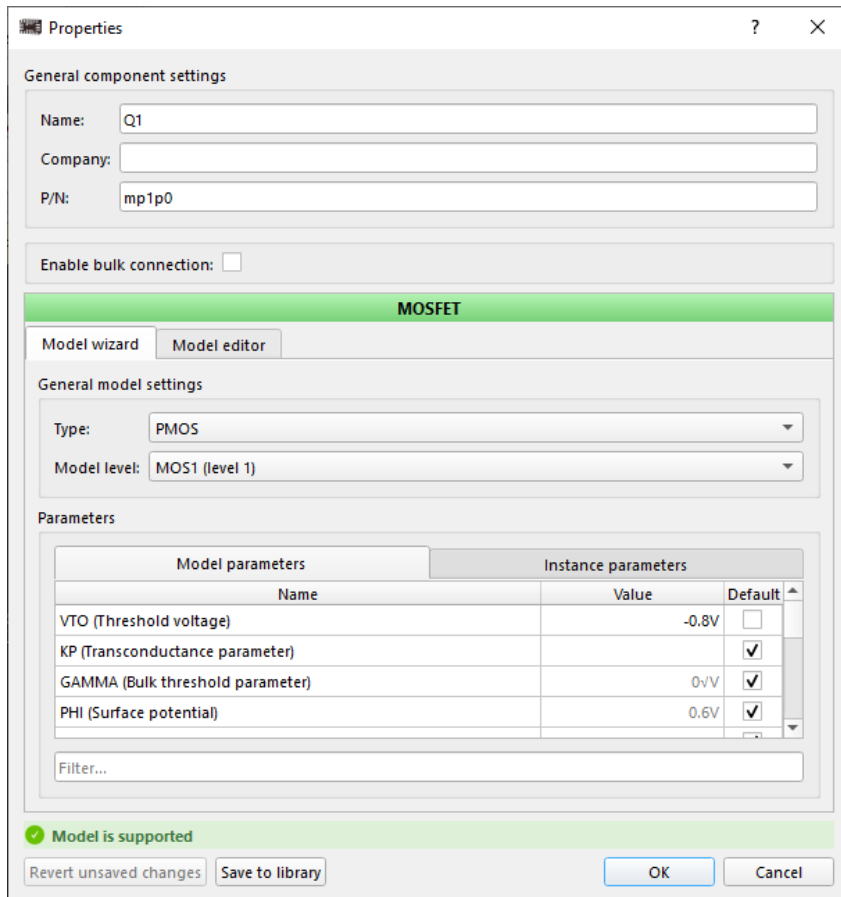

**Model properties window**

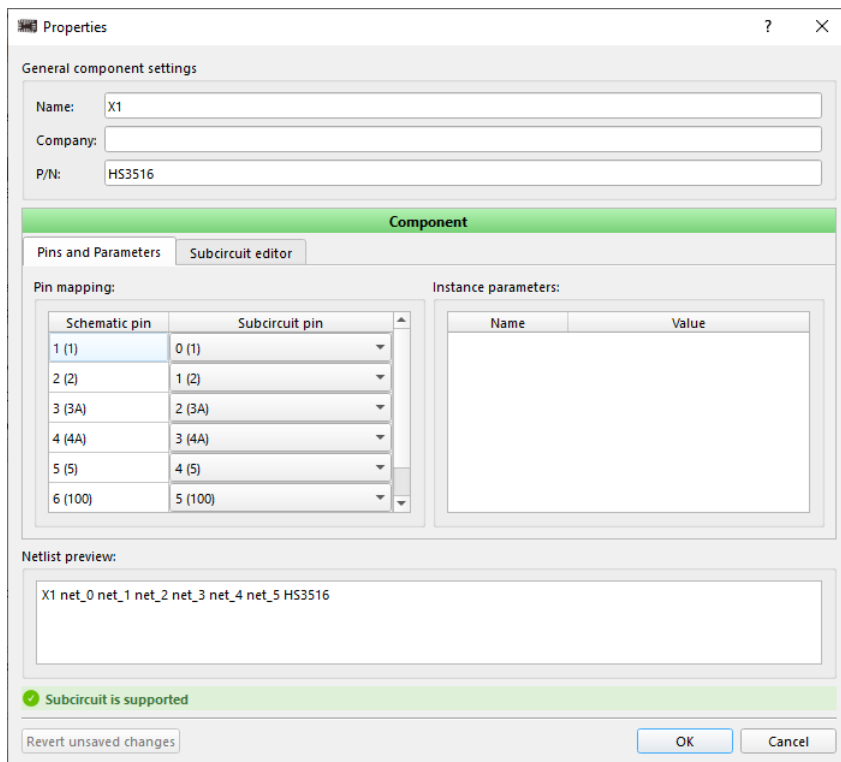

**Subcircuit properties window**

## 2.4.4 Source Setup

A voltage or current source can be configured in the *Source setup* window. To open the window, double-click a source or click *Configure* on the *Properties* panel.

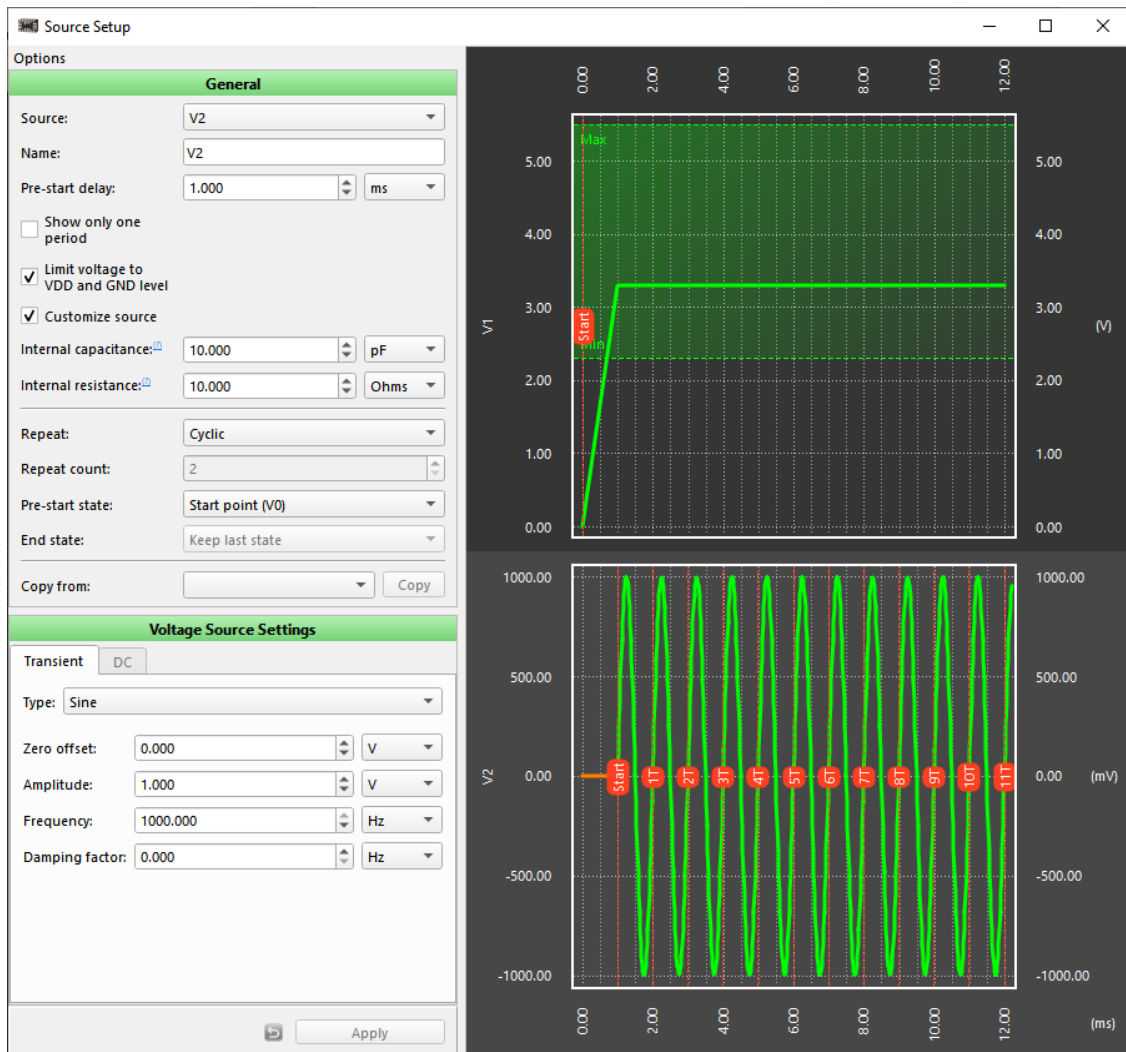

**Source Setup Window**

The set of settings and the window view differs depending on the simulation analysis type (read more about analysis types in section [2.4.7 Debugging Controls](#)). In the *Options* section, you can set the general and waveform-specific parameters related to the time intervals and the periods.

You can use the *Customize source* property to activate two additional parameters:

- *Internal capacitance* — the capacitance between the voltage source terminal and the ground.

This value can be used to model a VDD bypass capacitor or IC pin parasitic capacitance

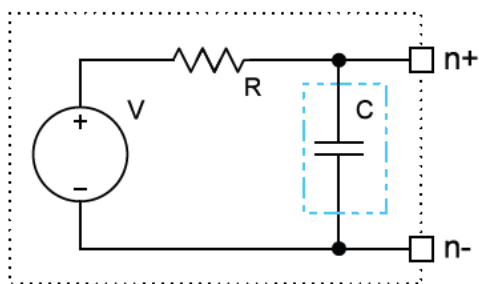

- *Internal resistance* — the output resistance of the generator. A non-ideal (real) voltage source is modeled with an ideal voltage source and resistance connected in series

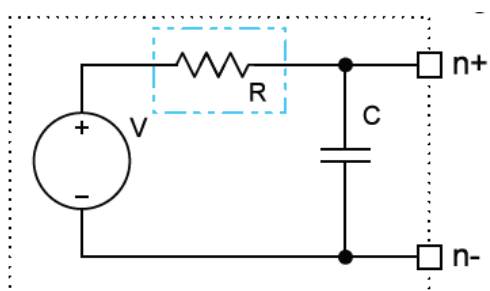

If you need to duplicate the configured settings from one source to another, use the *Copy from* property.

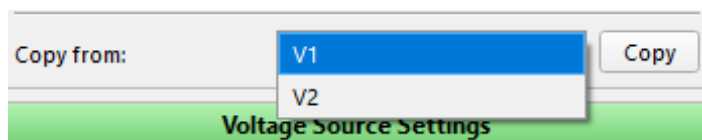

**Copy from property**

## Custom Signal Wizard

In addition to configuring the specific waveform types (e.g., DC, sine, trapeze, etc.), it is also possible to set a custom waveform shape. *Custom Signal Wizard* allows creating, importing, and editing the signal for the simulation voltage or current sources. The signal may be constructed by manually adding points or importing a custom list of points from an external source.

To open the *Custom Signal Wizard*, select *Custom signal* in the *Type* dropdown and click *Set Signal*.

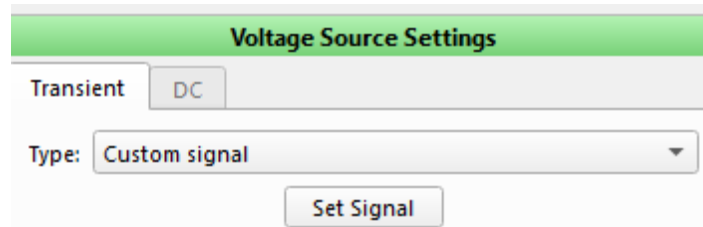

### Custom waveform option

The examples of possible signals are shown in the pictures below.

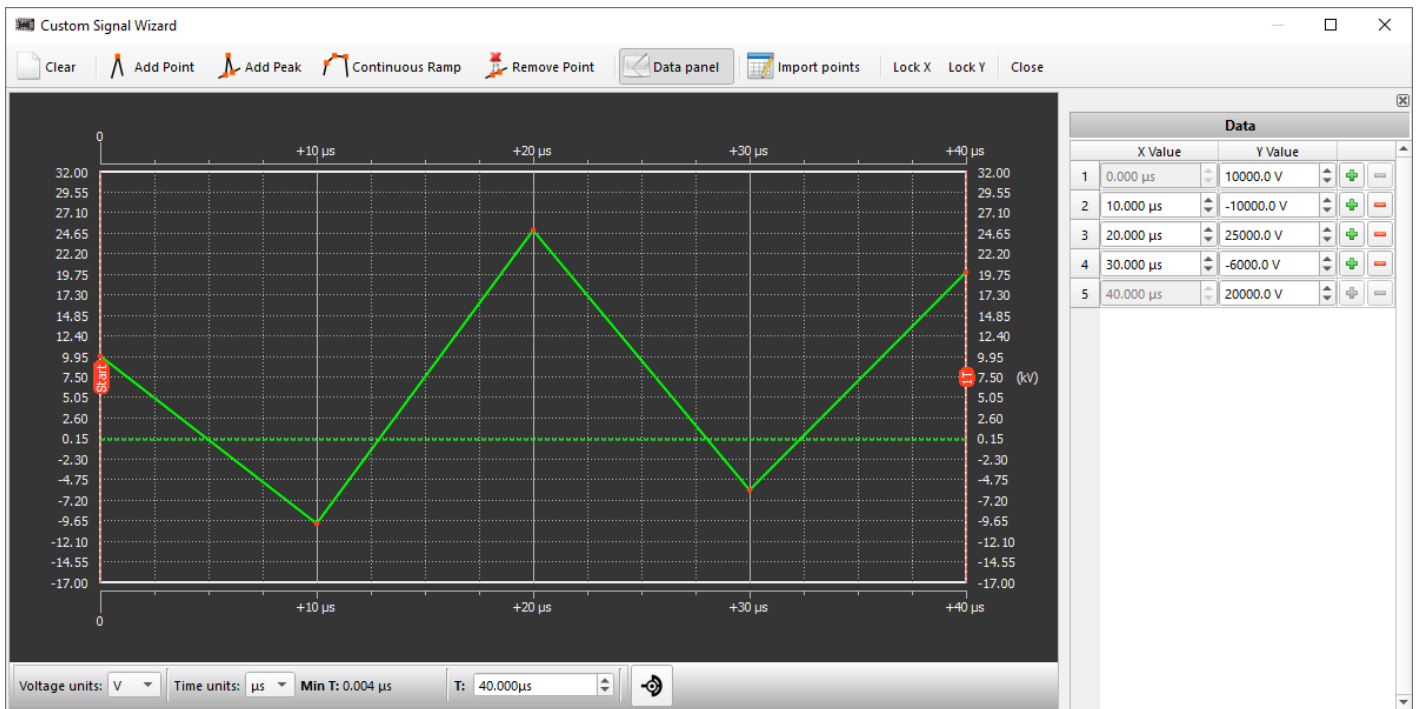

### The standard editing process in Simulation Custom Signal Wizard

The *Custom Signal Wizard* allows importing a set of points in different formats. Signals of various complexity, duration, and amplitude are accepted. For signals consisting of large amounts of data,

editing may be limited, and the simplified signal is shown. See the example below.

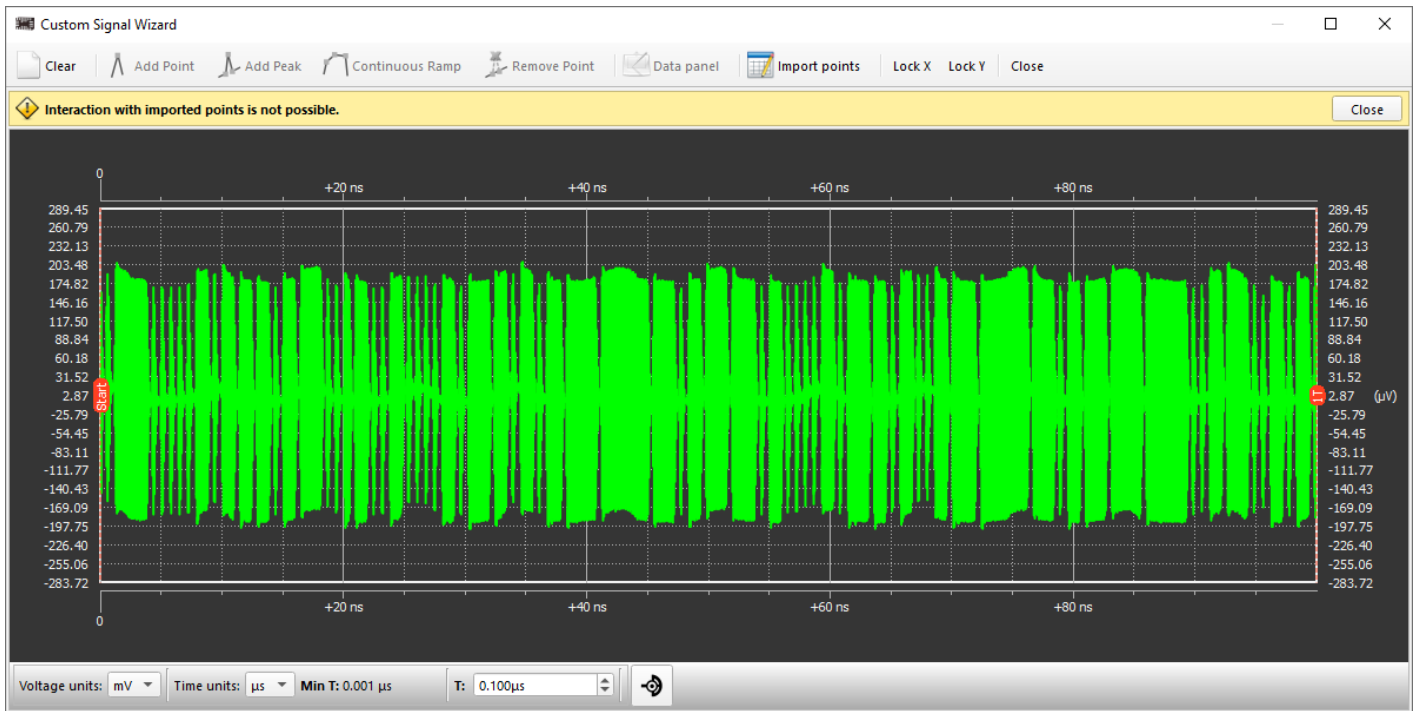



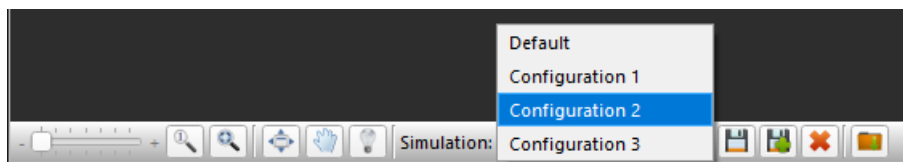

**An imported waveform with a large number of points (above 1000)**

## 2.4.5 Simulation configurations

You can save the snapshots with the simulation configuration state and switch between them. The snapshot stores only the elements that belong to simulation. An asterisk next to its name indicates the modified state of the snapshot. You can also import the saved configuration state from another project for the same Part Number.



**Simulation configuration**

-  Save the current configuration state
-  Save a new configuration state
-  Delete the selected configuration
-  Import new configuration

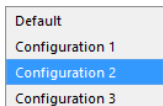

**The list of saved configurations**

## 2.4.6 Probes

The probes provide you with the data that components yield during the simulation. You can attach a probe to a pin to reflect the component parameters. The active probes remain on the hidden components, and their data will be displayed in the simulation results.

Two types of probes are available, namely voltage and parametric probes.

### Voltage probes

The voltage probe is used to capture an output signal from a pin. You can add a probe to the external component terminals and macrocell output pins. Click the respective buttons on the toolbar and then the pin to add or remove a probe. It is possible to add the probes to all available pins or remove all of them. In one click (see the arrow next to the add/remove button). You can also delete the probe from the context menu of a probe icon.

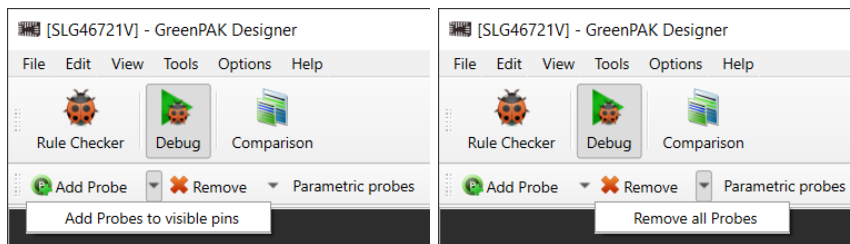

**Add/Remove voltage probes**

### Parametric probes

The parametric probe allows monitoring the macrocell parameters in simulation, e.g., the counted value in the CNT/DLY blocks. To show the list of available probes, click the *Parametric probes* button on the toolbar.

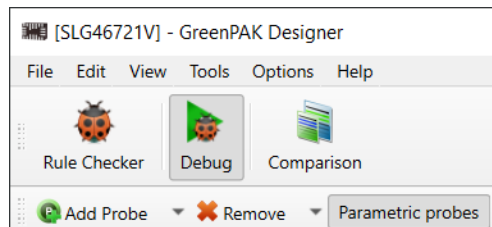

**Active parametric probes button**



Add a probe by selecting a component and a property in the dropdowns on the respective panel.

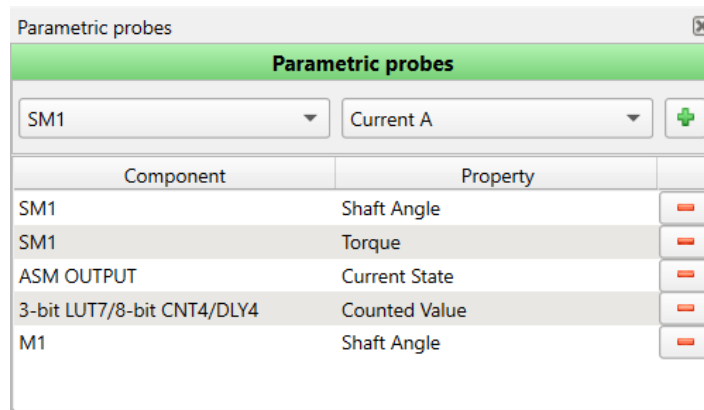

**Parametric probes window**

Right-click the parametric probe sticker to facilitate adding/removing a probe and editing the probe parameters.

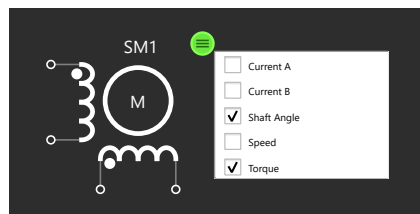

**Parametric probe sticker**

## 2.4.7 Debugging Controls

The *Debugging Controls* panel appears once *Software Simulation* is selected in *Development Platform Selector*.

Choose between the analysis types before starting the simulation process. There are two types of simulation analysis: *Transient* and *Parametric DC*.

### Transient analysis

*Transient Analysis* settings define the time span for simulation, maximum time step, source voltage, and temperature.

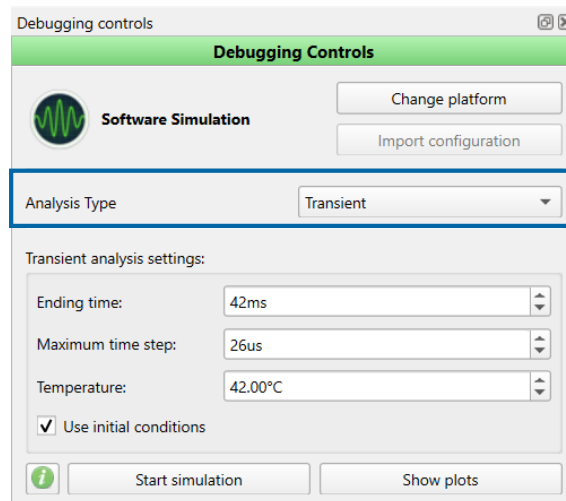

**Transient Analysis Debugging controls**

*Use initial conditions* is an optional checkbox that allows setting an initial charge different from the default value (0) for components like a capacitor or inductor. Also, this checkbox enables setting all node voltages in a circuit to 0V at the initial time point.

### Parametric DC Analysis

You can customize the *Schematic library* objects' properties by using the *Parametric DC* analysis. The parameter sweep can be configured in the *Parametric DC analysis parametrization* window. Click *Open parametrization settings* on the *Debugging Controls* to activate it.

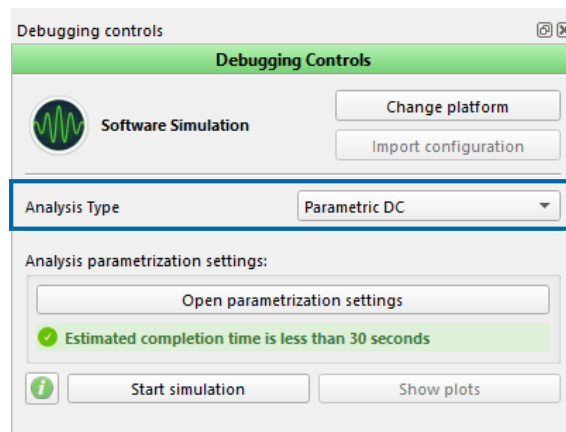

**Parametric DC Analysis Debugging controls**

Analysis parametrization can set active parameters for external components, circuit temperature, and macrocell properties (e.g., *Resistance (initial data)* for *Digital Rheostats*).

Parametric DC data has two range types:

- *From/To* — simulate data between the set *From* and *To*, incrementing by *Step*
- *List* — use data in a semicolon-separated list

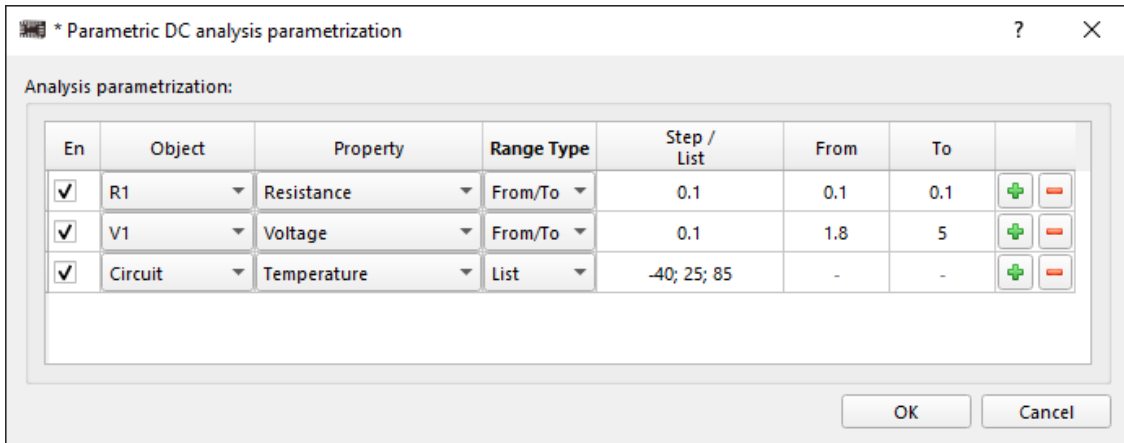

**Parametric DC Analysis Window**

### Estimated completion time

It is possible to define simulation runs that may exceed the available resources on your computer, which can potentially make your computer unstable. Longer runtimes require greater resources on your computer, including CPU and memory.

The software estimates the runtime based on sample points in three broad categories: *green*, *yellow*, and *red*. The estimated runtime may vary depending on different factors (e.g., the computer's performance).

### 2.4.8 Simulation progress

The *Simulation in progress* window appears while processing data. Simulation time remaining is estimated dynamically.

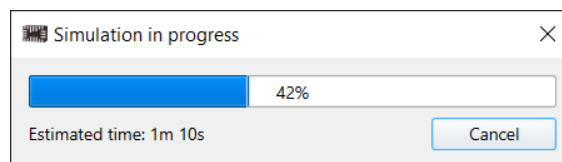

**Simulation in progress**

You can interrupt the process by clicking *Cancel*. The simulation results will still be displayed based on data that the tool managed to process before it was canceled.

## Scheme issue resolution

If a simulation attempt encounters a known simulation error of the scheme convergence, the simulation internal algorithm attempts to adjust the circuit by changing the component properties or scheme parameters and re-init the simulation. In this case, the *Simulation in progress* window indicates the current attempt count.

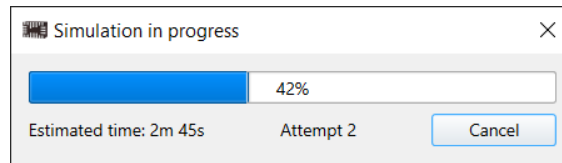

**Simulation in progress (2nd attempt)**

The simulation error is shown only when the algorithm cannot resolve the problem.

If the simulation process fails, the corresponding error window is shown. It may contain a brief description and details from the simulation engine about the cause.

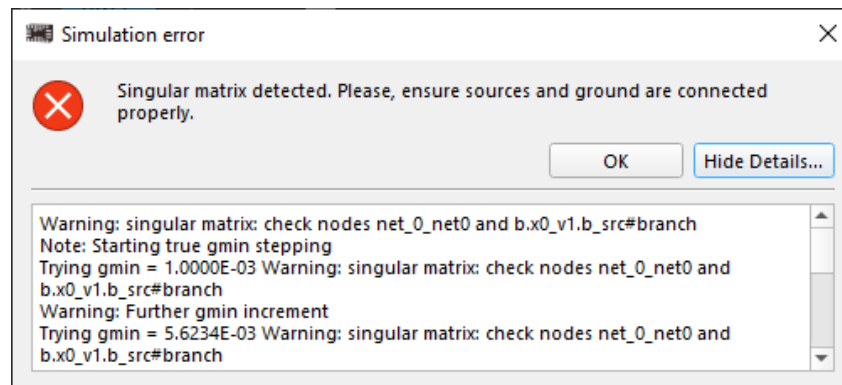

**Simulation error window**

After the issues are resolved and the simulation process is completed, you can observe the simulation report by clicking the *Show report* button on the *Simulation Results* window.

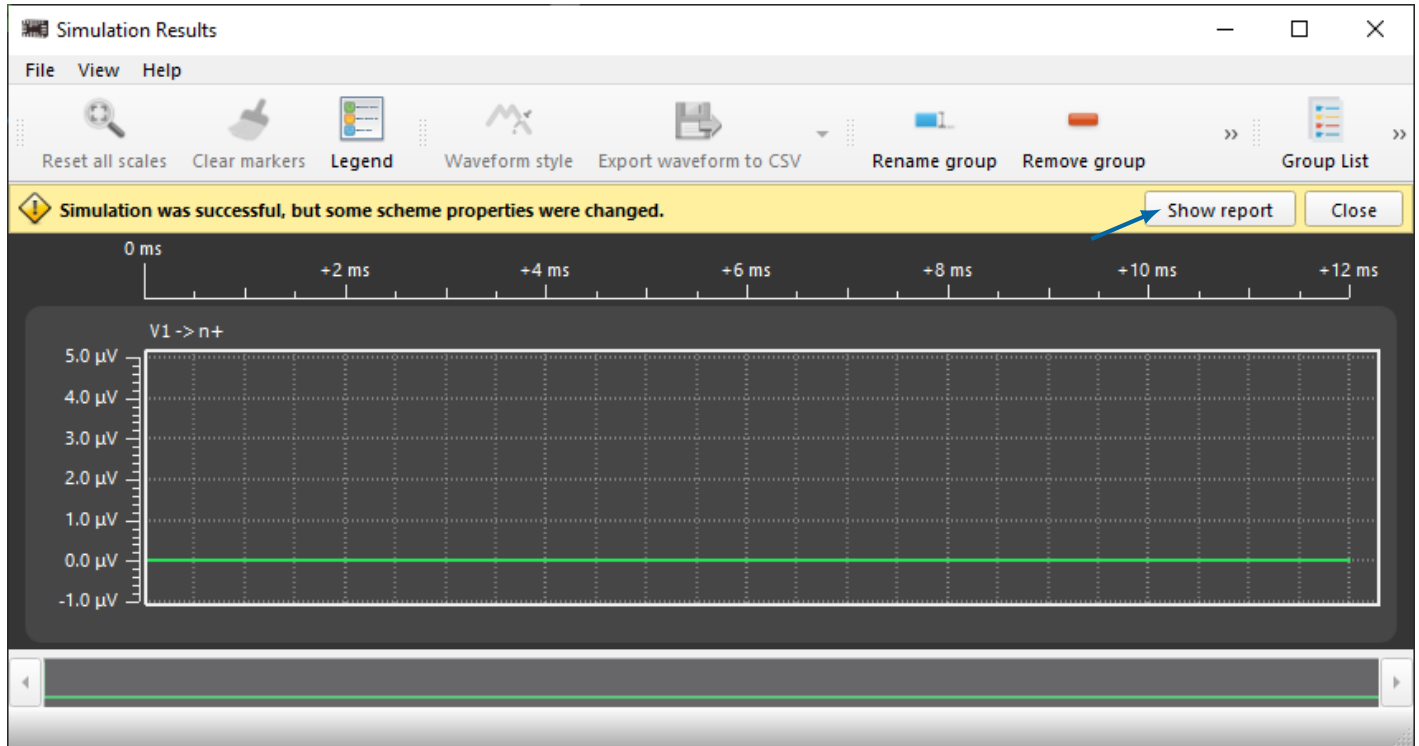

**Show report button**

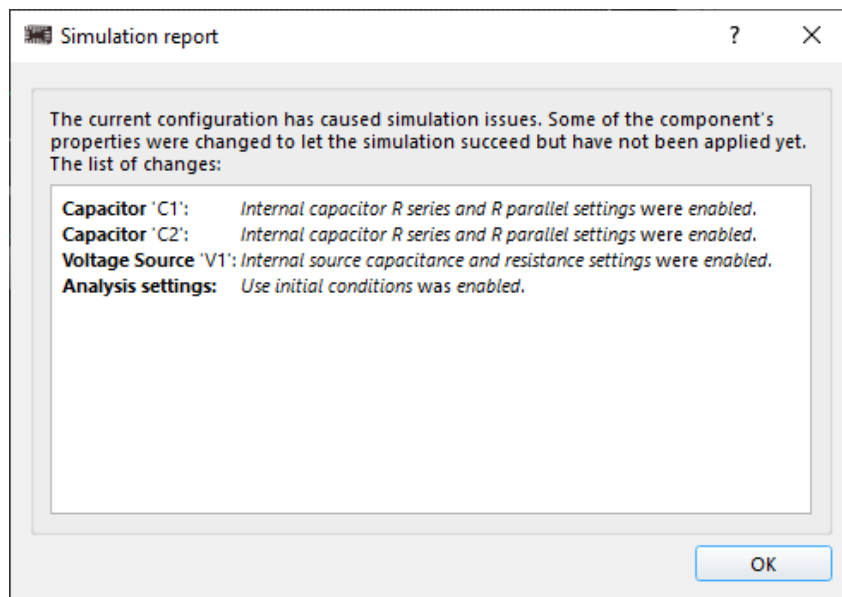

**Simulation report window**

## 2.4.9 Simulation Results window

The *Simulation Results* window opens after the completed/interrupted simulation process. If you close the window, you can reopen the latest simulation results by clicking *Show plots* on the *Debugging Controls* panel.

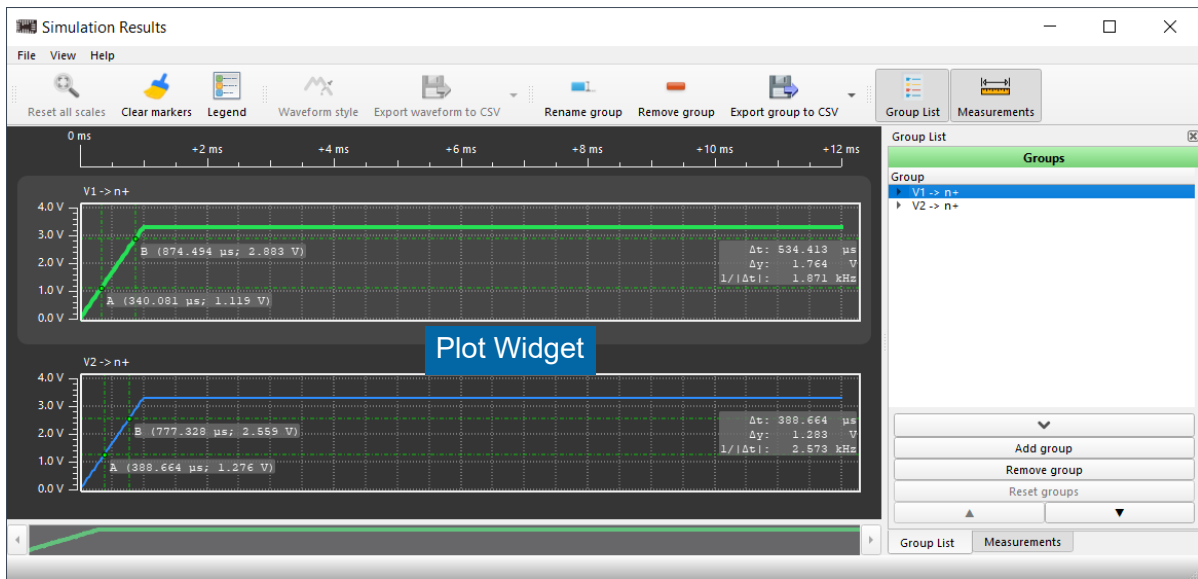

**Simulation Results**

The *Simulation Results* window contains the following sections:

### Toolbar

*Toolbar* provides operations with the plot area, waveform style, group management, and results data export. You can export a single waveform or a whole group to a .csv, .vcd, or .png file. You can also export all waveforms as a single .png file.

### Plot widget

The *Plot* widget is the main area displaying a waveform or group of waveforms. It is possible to manipulate the plot controls in several ways. In addition to the toolbar controls, right-click the plot to open the context menu and access the available actions. Also, see the [keyboard commands](#), which can be used instead.

You can set the markers with a **Ctrl + right and left click** to see the signal information in the particular point. See the examples of markers and  $\Delta t$  and  $\Delta V$  parameters on the *Plot* widget:

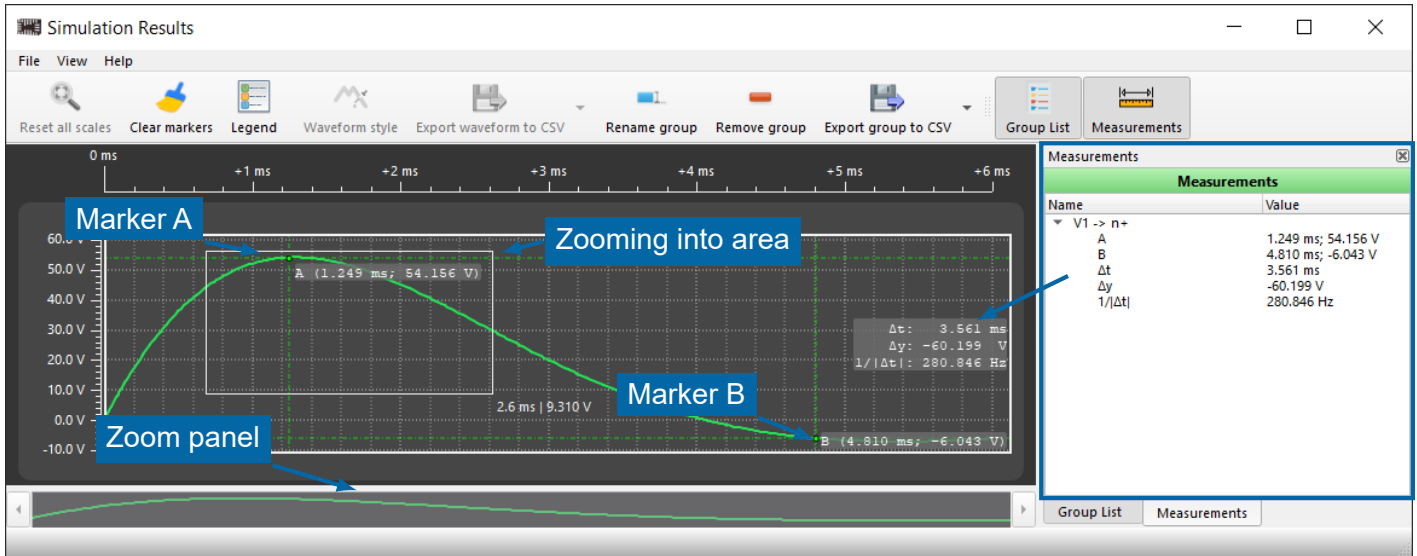

**Plot widget and Measurements**

## Group List

The *Group List* panel contains the list of all captured signals and source generators in groups.

Click the waveform on the panel to modify its style, color, or width by choosing the *Waveform style* option from the toolbar or context menu. Also, use the context menu to rename the group.

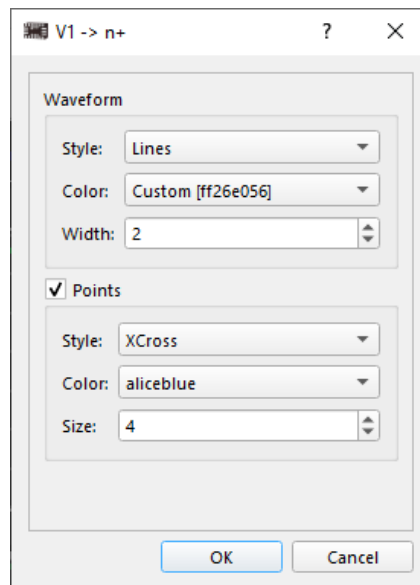

**Waveform Plot Configuration window**

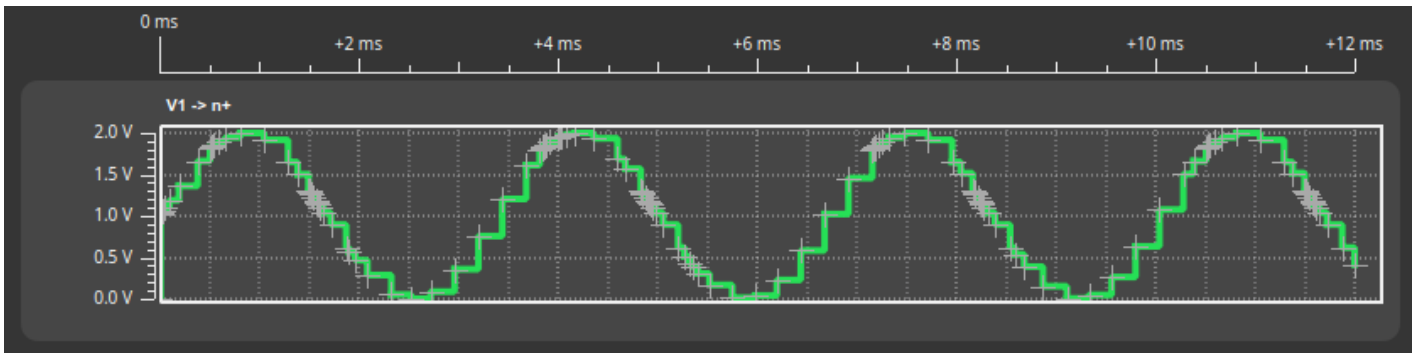

A sine simulated with huge interval settings

The *Group List* bottom controls let you operate the waveforms.

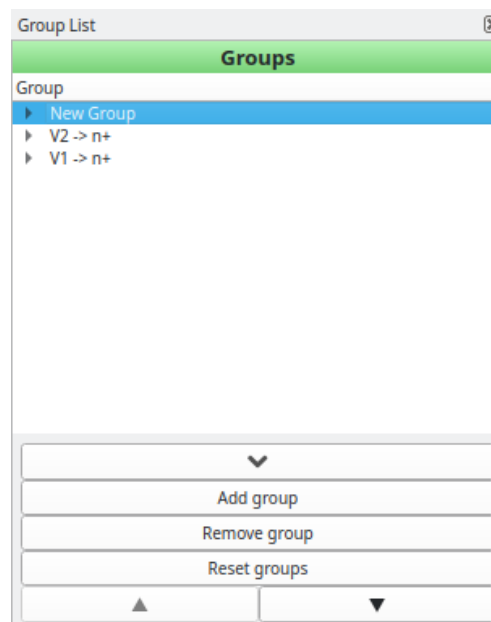

Group List

Group controls include:

- ▶  $\downarrow$  /  $\uparrow$  — fold/unfold the controls
- ▶ *Add group* — create a group by selecting one or more signals from the list. The signal(s) can be combined in a group of *analog [A]*, *digital [D]*, or *parametric probe [B]* waveforms. You can create



multiple groups with the same waveform reused.

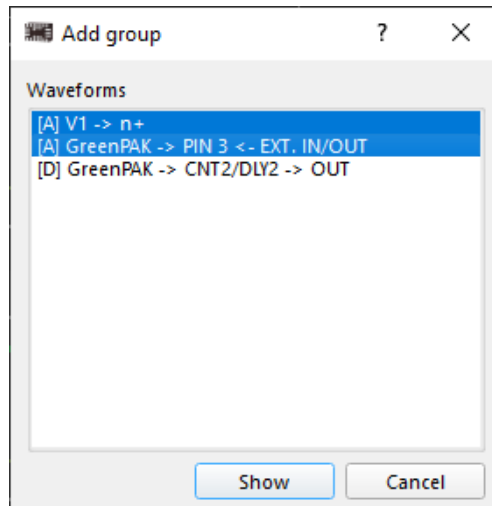

**Add group menu**

- *Remove group* — delete the selected group
- *▼ / ▲* — move a selected group up or down
- *Reset groups* — restore default and remove all added groups

## Measurements

This panel displays measurement data for the added plot markers.

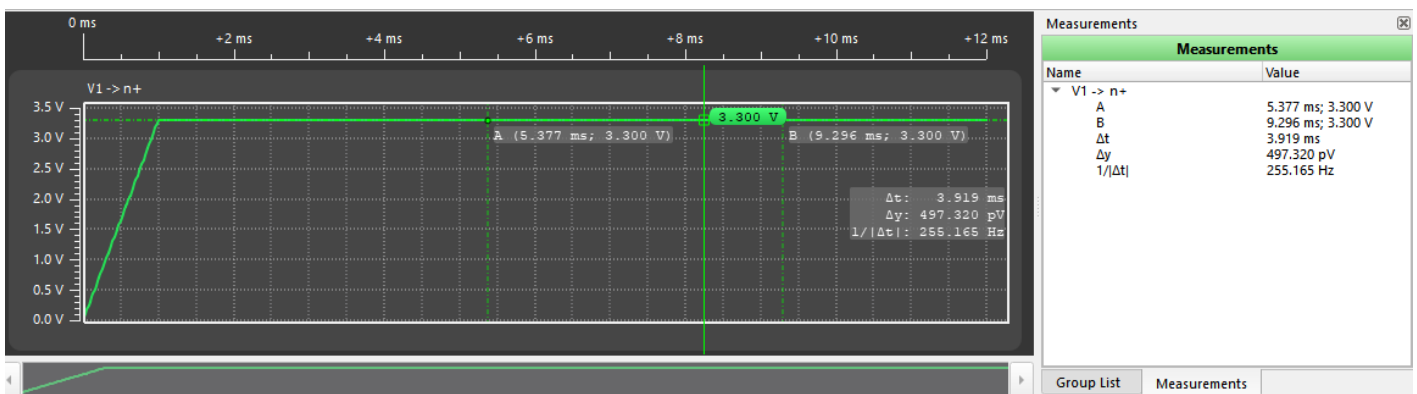

**Measurements panel**

## 2.5 FPGA Editor tool

The *FPGA Editor* is a complex software tool designed to create and configure the FPGA logic. The editor allows you to create designs for Field-Programmable Gate Arrays (FPGAs) using Verilog, a Hardware Description Language (HDL). Before you program your design onto the FPGA, the editor provides an option to simulate it first and ensure it's correct.

The *FPGA Editor* includes a graphical representation of the Register Transfer Level (RTL) for the FPGA logic you designed. You can also use an additional macrocell constructor instead of writing a Verilog code, manually place the required blocks to the work area, connect them, and convert the complete design into the code representation.

In addition, *FPGA Editor* allows you to work with external designs by importing files with the created logic mapped to the components. Find the description of these and some additional features in the sections below.

### 2.5.1 Flowchart

We have created a flowchart to narrow down and follow the basic steps from start to finish. The flowchart shows all the important aspects of using the *ForgeFPGA* software.

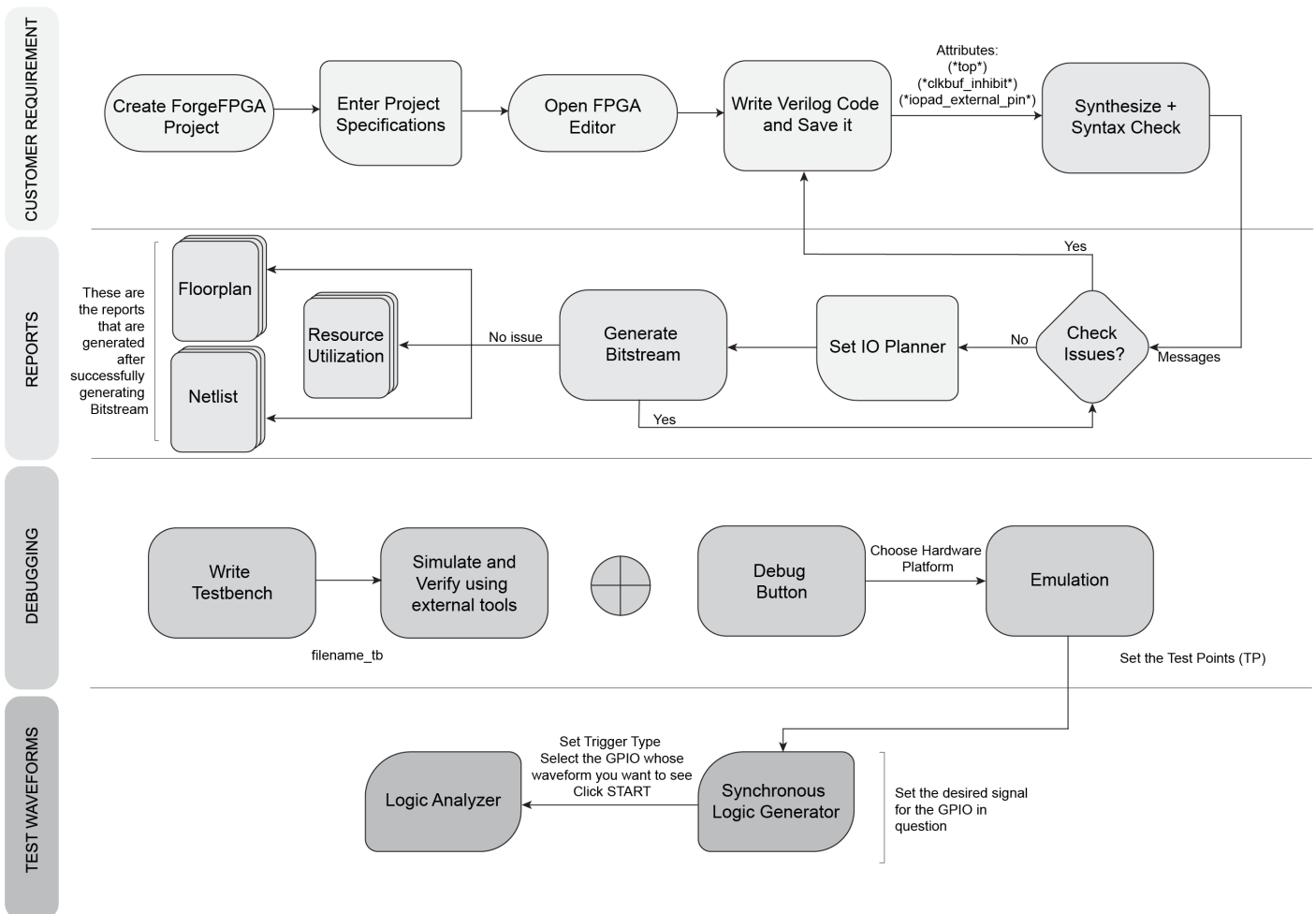

**Software flow**

## 2.5.2 Interface overview

To open *FPGA Editor*, click the respective button on the toolbar or double-click the FPGA Core component on the work area.

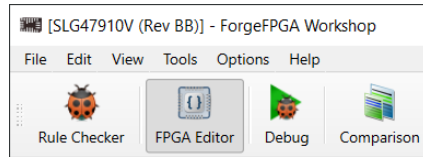

FPGA Editor button on the toolbar

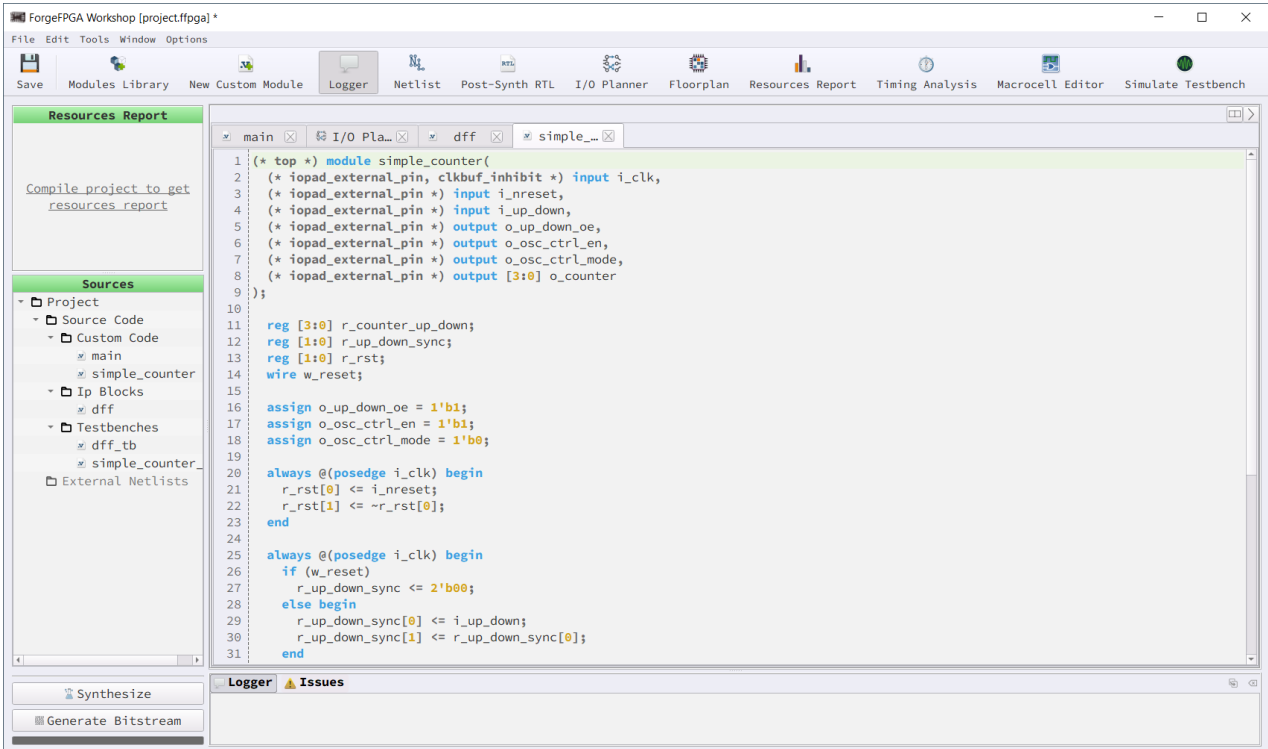

FPGA Editor

## Toolbar

The top toolbar provides quick access to a set of tools and actions. See the description of all available tools in the next sections.

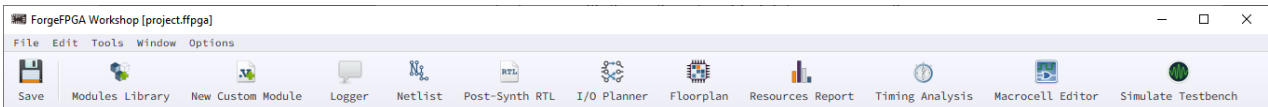

Toolbar

## Control panel

From the left control panel, you can access:

- ▶ *Resources Report* — an extract from the resource usage report. It shows the part of available resources utilized by the design sources
- ▶ *Sources* — a list of all the Verilog sources and external netlists you have in the current project file. Add the *Sources* from the toolbar by clicking *New Custom Module* or select one from *Modules Library*. In addition, you can import the external module or netlist by reaching *File* → *Import*

Here you can find the following subcategories:

- *Custom Code*
- *IP Blocks*
- *Testbenches*
- *External Netlists*

Customize the *Sources* list via context menu with the options to add, delete, or rename the sources.

- ▶ *Synthesize and Generate Bitstream* — main controls to run toolchain on your design to produce chip configuration. Hover over the icon next to the procedure button to see the status details, such as whether the procedure was successful, failed, or if the Verilog file has been changed

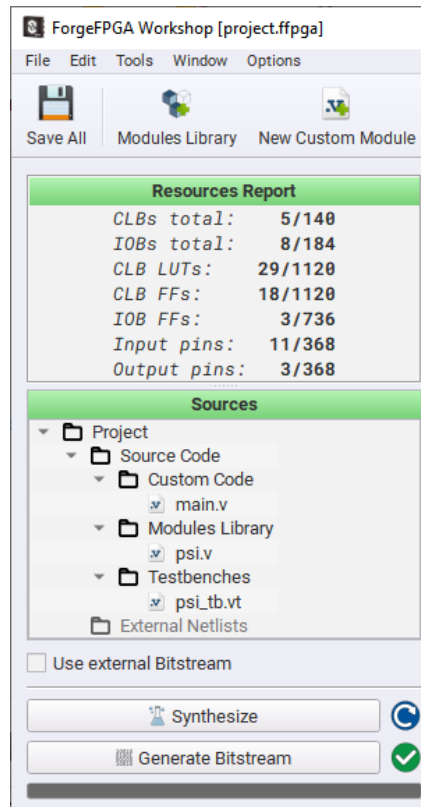

**Control panel**

**Note:** Make sure you save the all module changes before performing procedures to process the most updated data.

## Messages panel

Here you can see the generated messages that appear after you use *Synthesize*, *Generate Bitstream*, or *Simulation* procedure.

- *General Log* — shows the information messages along with warnings and errors that were recorded while processing the design
- *Synthesis/Bitstream Log* — provides the output generated while the procedure is performed
- *Issues* — displays the warning and error messages that are automatically generated by the software when required. Once you receive a syntax error, you can right-click it and select *Show in Editor* to highlight a line in your Verilog code with a detected mistake

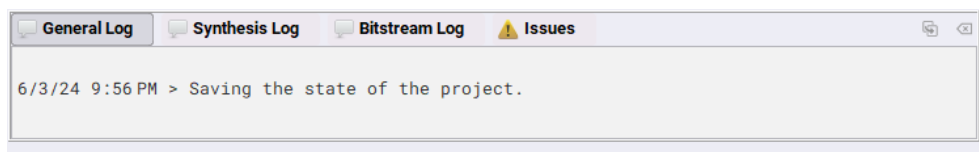

**Messages panel**

## Additional controls

See the list of *FPGA Editor* controls that can enhance your user experience (the controls availability may depend on the selected tool):

- *Split* — divide your work area side-by-side to work simultaneously with more than one tool. Focus on the split area and click the tool to add it to the desired side. You may chose to duplicate the same tool on both sides, which is available for most of the tools, e.g. *I/O Planner*, *Netlist*, *Post-Synth RTL*, etc.

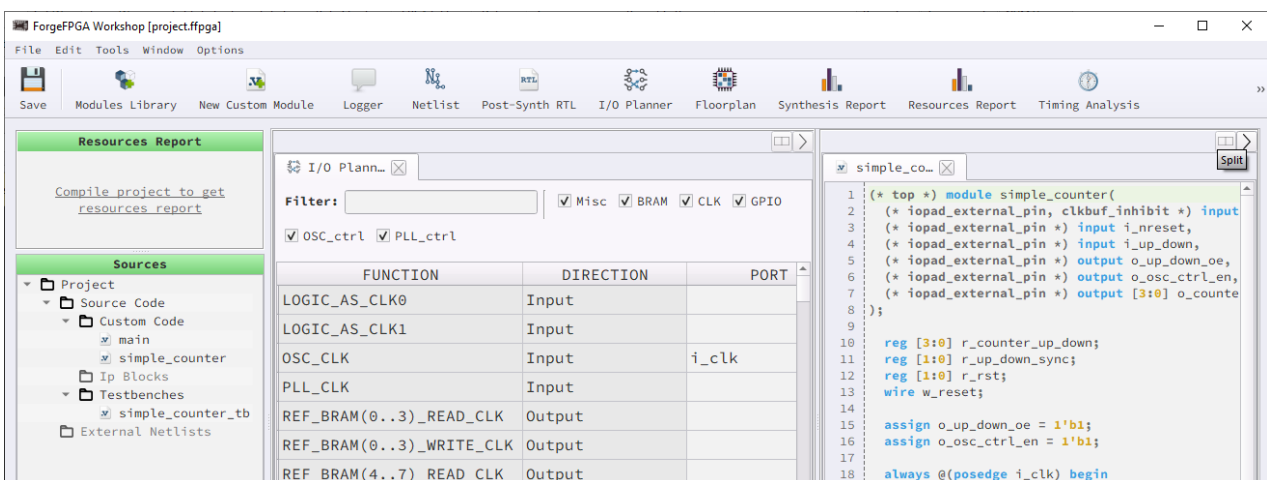

**Split**

- *Find* — activate the search field in the main menu, *Edit* → *Find* (Ctrl + F). You can enable the

feature for most of the toolbar tools, including the *Messages* panel

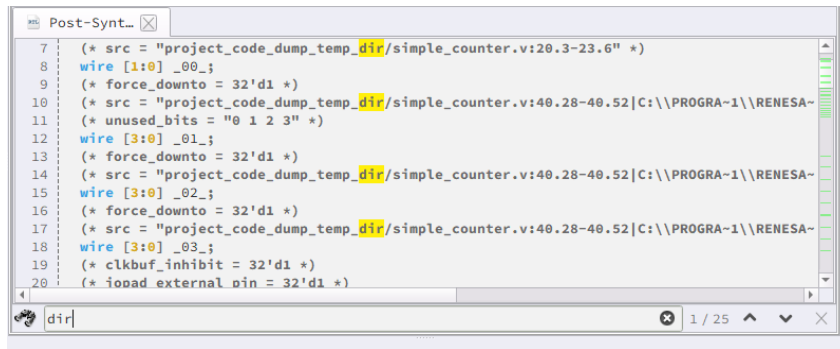

```
7 (* src = "project_code_dump_temp_dir/simple_counter.v:20.3-23.6" *)
8 wire [1:0] _00_;
9 (* force_downto = 32'd1 *)
10 (* src = "project_code_dump_temp_dir/simple_counter.v:40.28-40.52|C:\\PROGRA-1\\RENESA-
11 (* unused_bits = "0 1 2 3" *)
12 wire [3:0] _01_;
13 (* force_downto = 32'd1 *)
14 (* src = "project_code_dump_temp_dir/simple_counter.v:40.28-40.52|C:\\PROGRA-1\\RENESA-
15 wire [3:0] _02_;
16 (* force_downto = 32'd1 *)
17 (* src = "project_code_dump_temp_dir/simple_counter.v:40.28-40.52|C:\\PROGRA-1\\RENESA-
18 wire [3:0] _03_;
19 (* clkbuf_inhibit = 32'd1 *)
20 (* ionad_external_pin = 32'd1 *)
```

### Find

#### ► Footer controls:

- *Zoom* — zoom in/out the work area
- *Pan mode* — click, hold and drag the cursor to move the work area (use the middle mouse button as an alternative)
- *Zoom to selection* — click, hold and drag a cross cursor over the element you want to zoom
- *Align Vertical/Horizontal* — align the macrocells relative to each other on the work area
- *Snap to grid* — use for precise graphic alignment of the macrocells

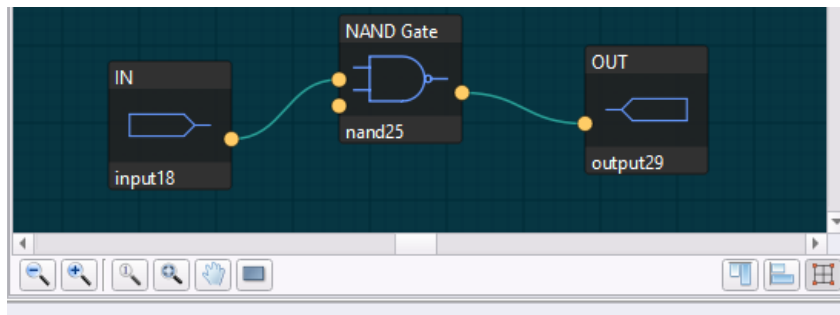

### Footer controls

## 2.5.3 Design Templates

*Design Templates* offer pre-built designs that you can seamlessly integrate into your project. You can find them in *FPGA Editor* → *File* → *Load Design Templates*.

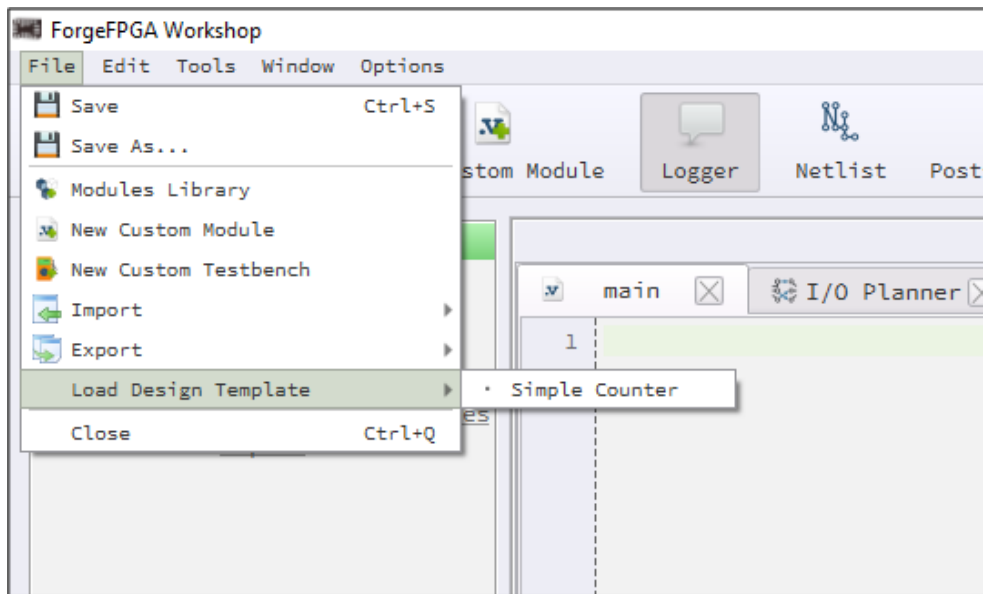

**FPGA Design Templates**

Upon selecting a design template, the *Design Template Wizard* will appear. It can guide you through component selection, IO spec diff review, and module name assignment.

- *Component Selection* offers you to choose the components you'd like to proceed with:
  - *Verilog Module*
  - *Verilog Testbench*
  - *IO Spec*

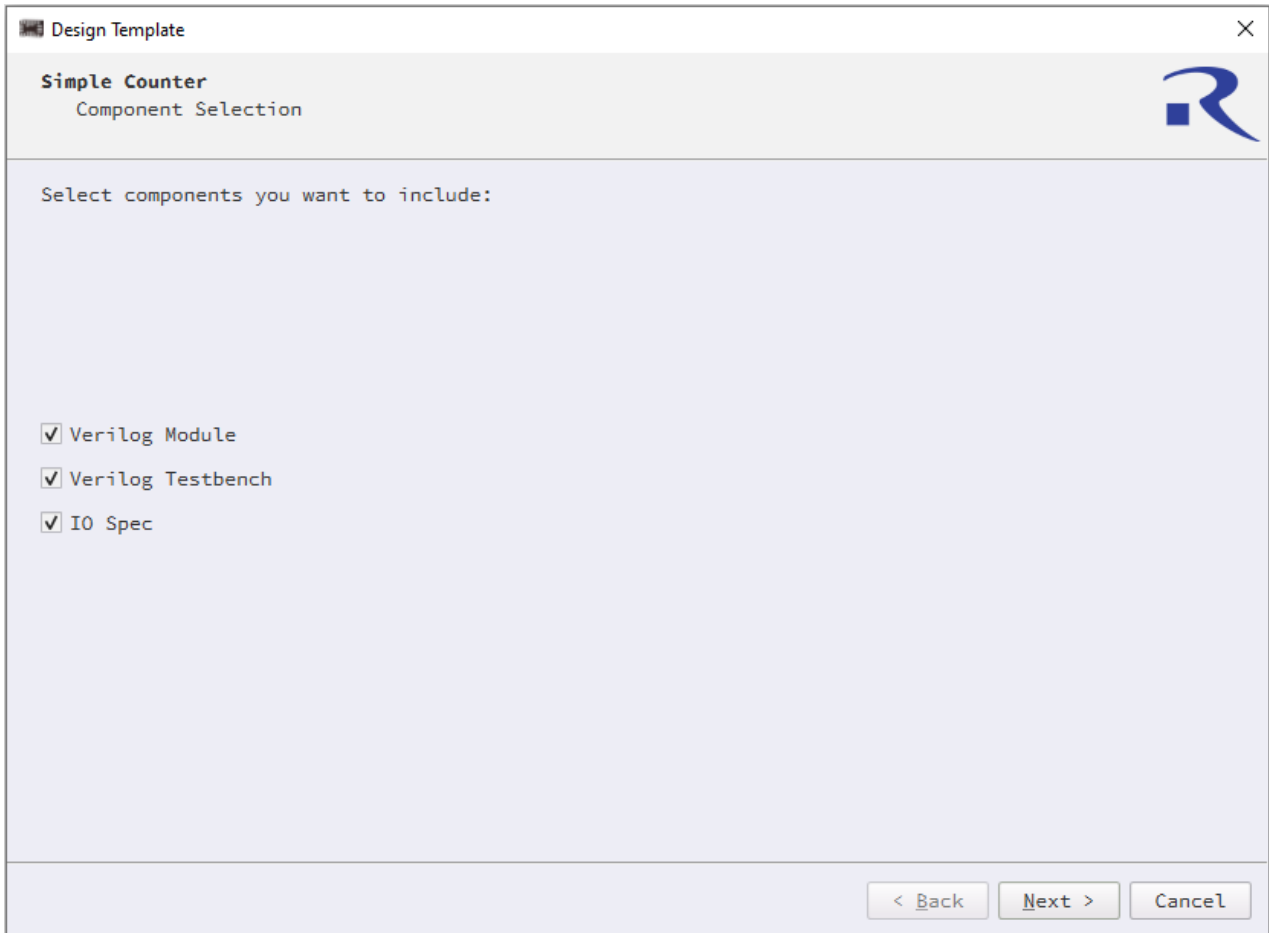

### Component Selection

Select all components simultaneously or individually, depending on the desired outcome for your project. The choices you make at this stage determine your next steps in the process.

- ▶ *IO Spec* generates an *IO Spec Diff*, presenting a comparison between your existing design port records and the ones associated with the selected template. This serves as a cautionary step as your current port configurations could potentially be overwritten by those of the chosen template. The software highlights conflicting entries in yellow. You can choose to focus solely on conflicts by selecting the *Show Conflicts Only* option. However, if you prefer not to review the *IO Specs*, the software streamlines the process by skipping the *IO Spec Diff*. In this scenario, the tool will prompt you straight to the *Module name*.



Design Template

**Simple Counter**  
IO Spec Diff

The following PORT records are used in this Design Template and will overwrite the existing rows in the I/O Planner. Are you sure you want to proceed with this change?

Show Conflicts Only

FUNCTION	CURRENT	POTENTIAL
FPGA_CORE_READY		i_nreset
OSC_EN		o_osc_ctrl_en
[PIN 17] GPIO4_OUT		o_counter[3]
[PIN 16] GPIO3_OUT		o_counter[2]
[PIN 15] GPIO2_OUT		o_counter[1]
[PIN 14] GPIO1_OUT		o_counter[0]
[PIN 13] GPIO0_OE		o_up_down_oe
[PIN 13] GPIO0_IN		i_up_down
OSC_CLK		i_clk

< Back   Next >   Cancel

### IO Spec Diff

- ▶ *Module name* is a component that assists you in assigning names to your *Verilog Module* and/or *Testbench*. If you choose to skip *Verilog Module* and *Verilog Testbench* in the *Component Selection* window, the default names are assigned.

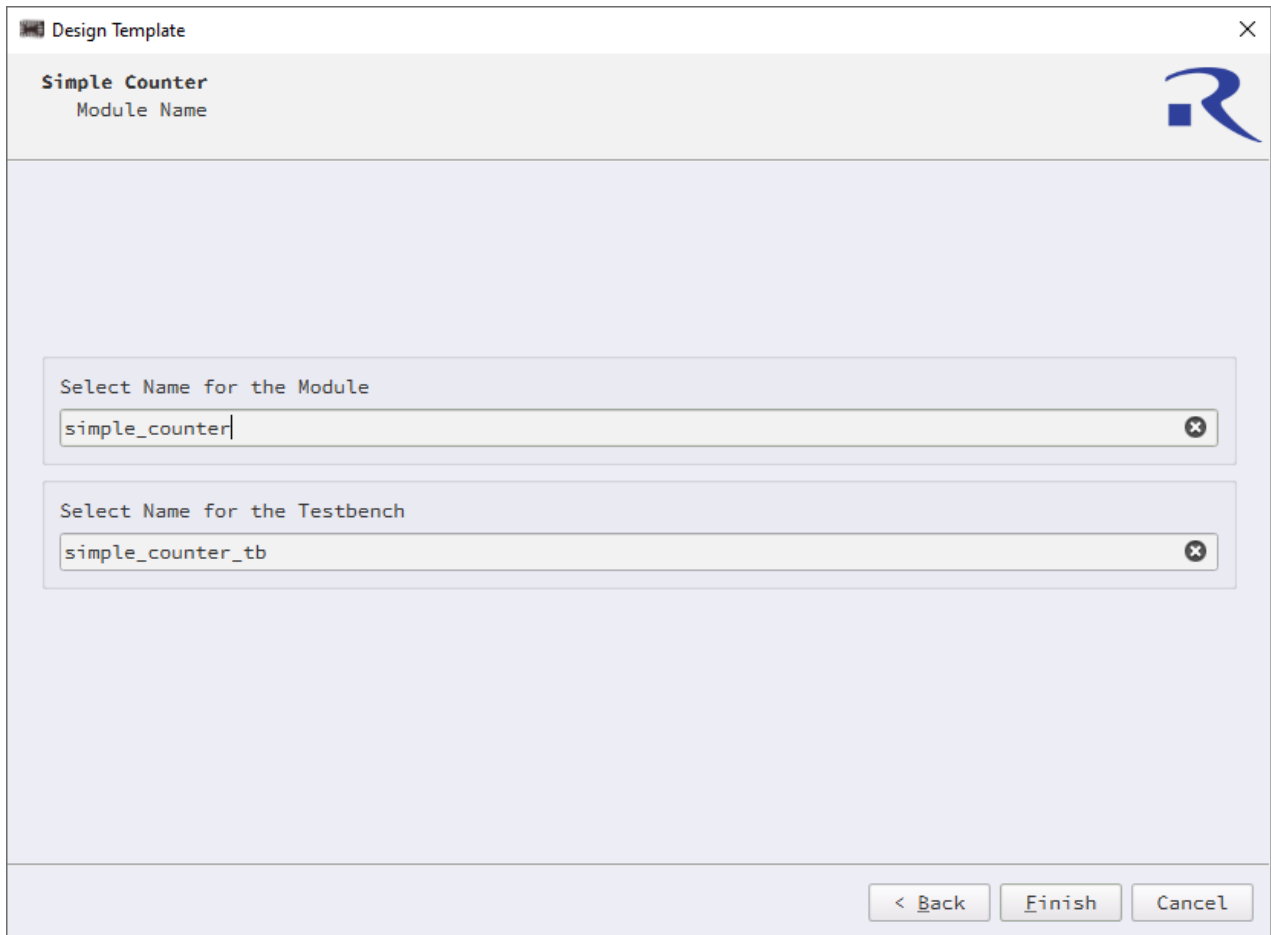

### Module Name

Once the template setup is complete, you will see new elements in your workspace. The *Design Template* Verilog code and *Testbench* names will appear in the *Sources* list, with corresponding tabs displaying the actual code and *Testbench* details. Additionally, your *I/O Planner* tab will reflect changes, showcasing the inclusion of port records from the selected design.

When the integration of the design template is done, you can assess its functionality by running a [simulation](#).

## 2.5.4 Writing Verilog code

The toolchain of the *ForgeFPGA* Workshop supports Verilog 2005 (IEEE Standard 1364-2005).

There are a few key code attributes that are important while working with the synthesis tool:

- ▶ `(* top *)` — the main module of your design should be marked with this attribute so the toolchain can successfully recognize which of the modules in the design is the top one
- ▶ `(* clkbuf_inhibit *)` — clocks signals in the input list of the main module should be marked with this attribute. This prevents clock buffer insertion by the synthesis tool, which may lead to the distortion of the clock signal name in the resulting netlist
- ▶ `(* iopad_external_pin *)` — all the external pins that are used in any source code need to be marked with this attribute

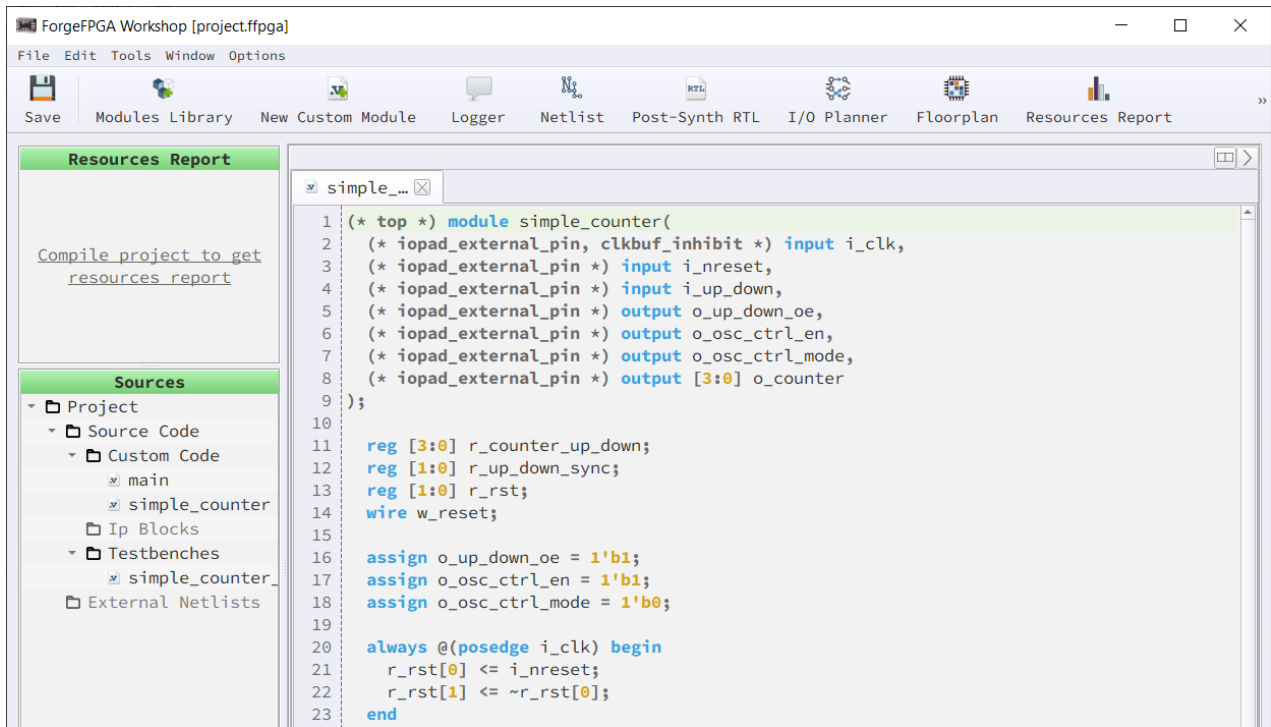

**Example of working with Verilog**

## 2.5.5 Modules Library

*Modules Library* is a comprehensive repository of pre-designed and pre-verified easy-to-integrate modules. This tool provides Verilog code for various hardware modules, accompanied by the testbenches to check their functionality using [simulation](#).

To open *Modules Library*, click a corresponding button on the toolbar or reach the main menu, *File* → *Modules Library*. Choose the module, set the required configurations, and add the name to complete the module creation.

Inside the *Modules Library* GUI, you can find the schematic, resource estimation along with the description of the block selected. The GUI gives a detailed explanation of all the input and output pins of the block and allows you to change the parameters as desired. This gives you the flexibility

to create the Verilog code of the module needed and its associated testbench with just a few clicks.

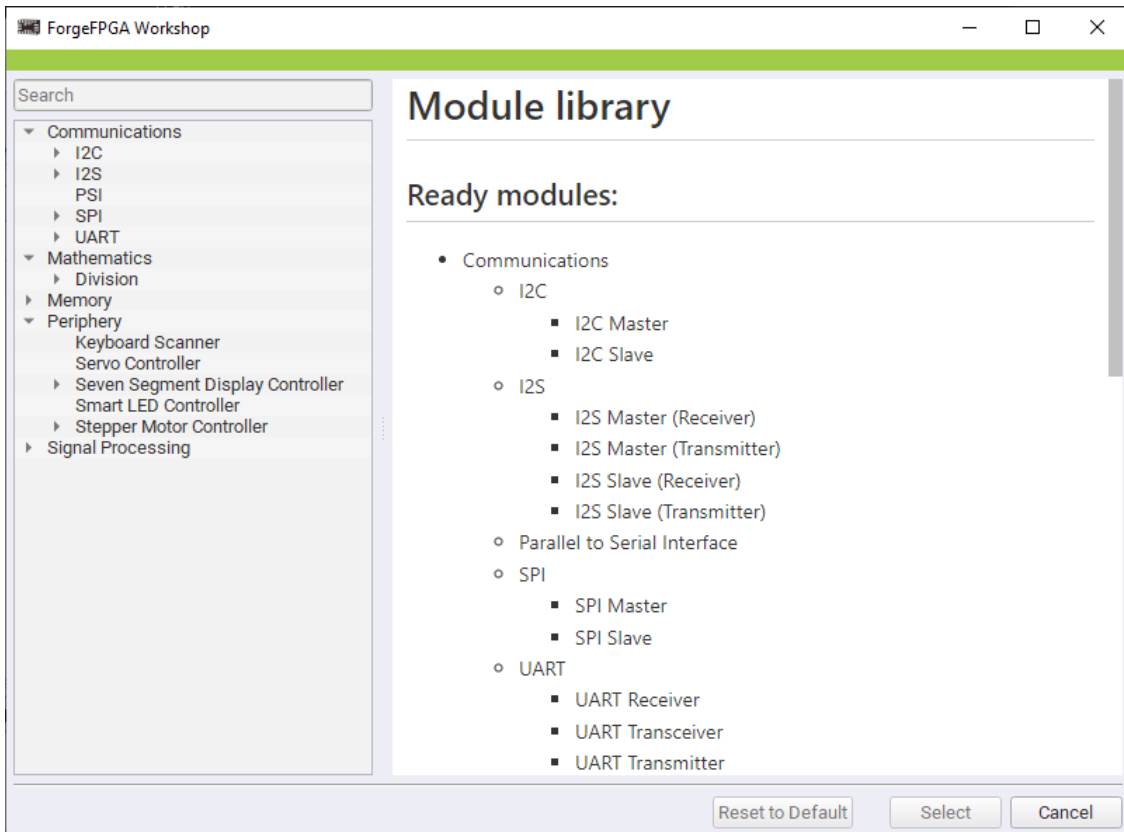

**Modules Library GUI**

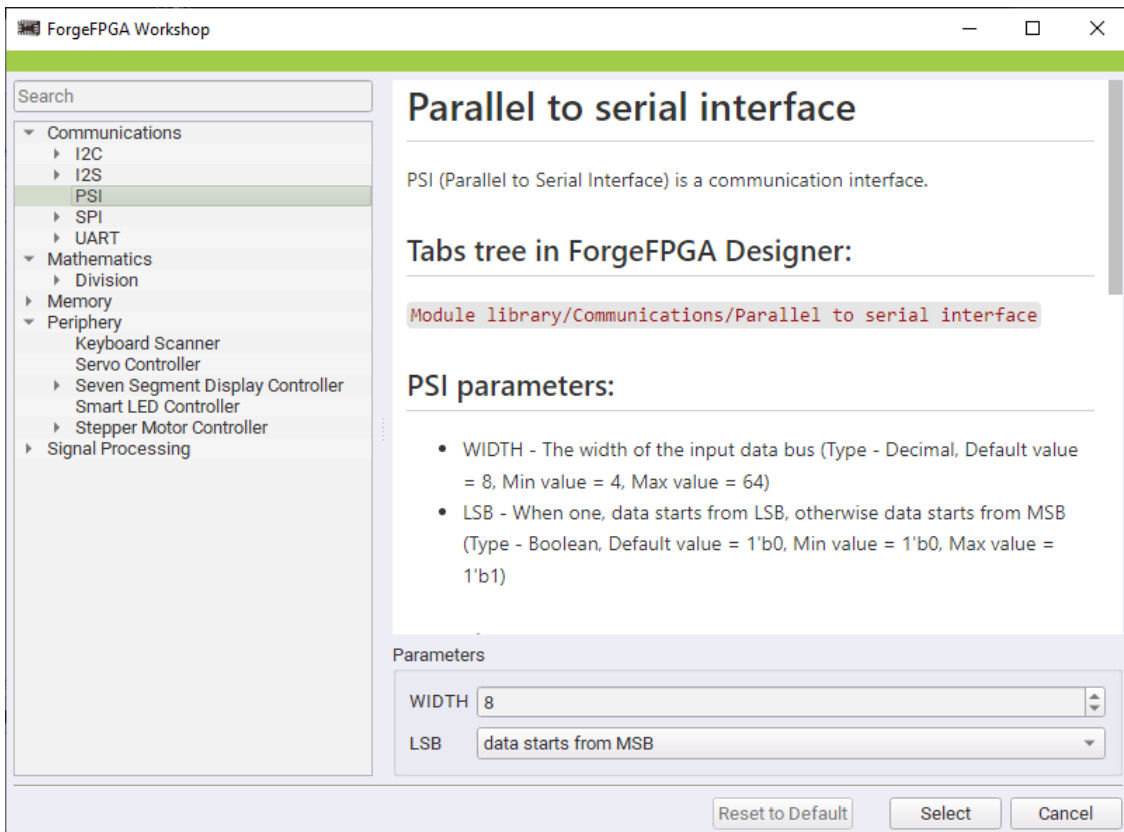

**Modules Library GUI with parameters**

You can check the added block on the [Sources](#) control panel under the *Ip Blocks* group. Along with the block, the testbench module is added, and you can find it under the *Testbenches* group. You can also add multiple modules to your design and work with them simultaneously.

## 2.5.6 Synthesis

*FPGA Editor* has a built-in synthesis tool that takes an input design and produces a netlist file. While performing synthesis, the input design is analyzed and converted into gate-level representation. To run synthesis on your design, click the *Synthesize* button in the bottom left corner of *FPGA Editor* or from the main menu *Tools* → *Run Synthesis*.

During the synthesis the software also checks the Verilog code for syntax errors. You can check the log output on the [Messages](#) panel. The synthesis is successful only when the code is syntax error-free.

## Netlist

The system generates a netlist file after the successful synthesis. It describes the components and connectivity of the source design and is required to perform the subsequent place-and-route procedure. You can access the netlist by clicking the toolbar *Netlist* button or from the main menu, *Window* → *Netlist*.

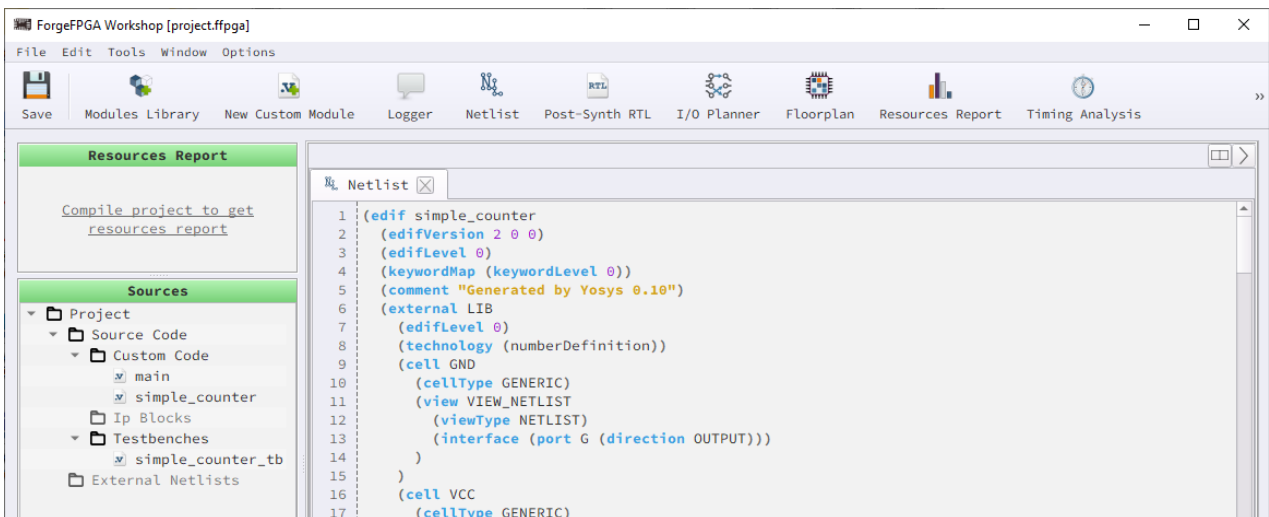

## Netlist

You can also import an existing netlist by clicking *File* → *Import* → *Netlist*. The external netlist will appear in the [Sources](#) tree.

## Post-Synth RTL

At the Register-Transfer Level, the design is represented by combinational data paths and registers. RTL synthesis is easy as each circuit node element in the netlist is replaced with an equivalent gate-level circuit. In Post-Synthesis RTL, the synthesized inputs are taken as a netlist. It helps in providing information about the clock and other clock-related logic in the design, which enables additional I/O planning.

You can find the Post-Synth RTL report by clicking the respective toolbar button or from the main

menu, *Window* → *Post-Synth RTL*. The report contains all the connections made within the module between the LUTs, FDREs, and Carry-Chain logics.

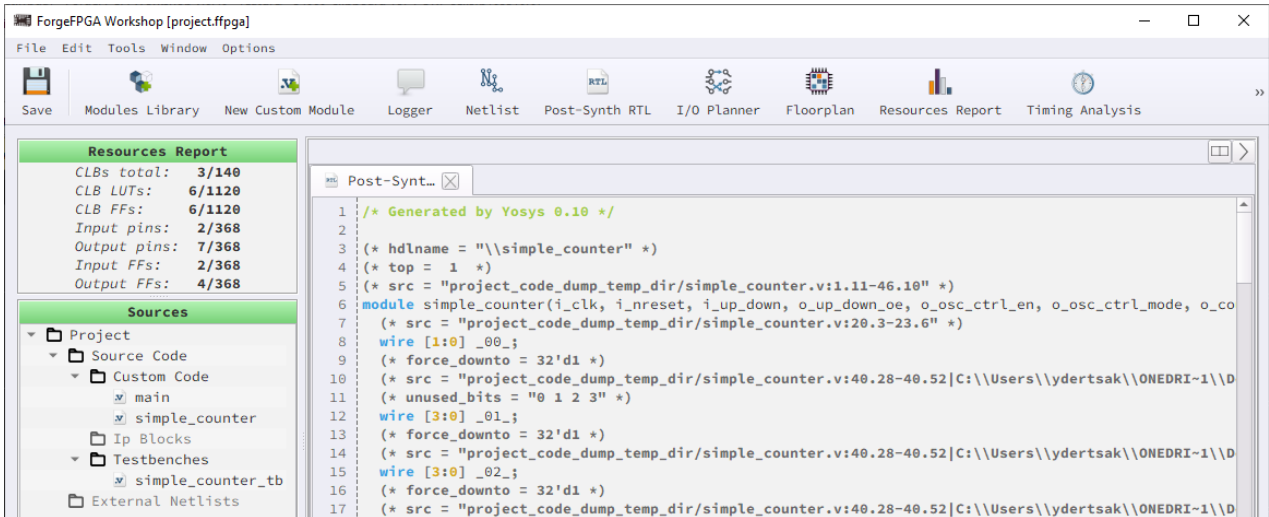

### Post-Synth RTL

### I/O Planner

Each I/O port available on FPGA has a dedicated function that can be mapped to your design using the *I/O Planner* tool. Click the corresponding button on the toolbar, or go to the main menu, *Window* → *I/O Planner* to launch the tool.

The *I/O Planner* tool is represented as a table with the following columns:

- *Function* — dedicated function, assigned to the port
- *Direction* — information about the pin mode
- *Port* — editable column, where you can input ports from your Verilog design to connect them to the desired functionality. Double-click a cell to see the list of all the ports defined in the Verilog code

**Note:** The cell suggests when the port name is invalid by showing the warning icon. Hover over the cell to trigger the info hint with more details. Correct the name to perform the procedures

successfully.

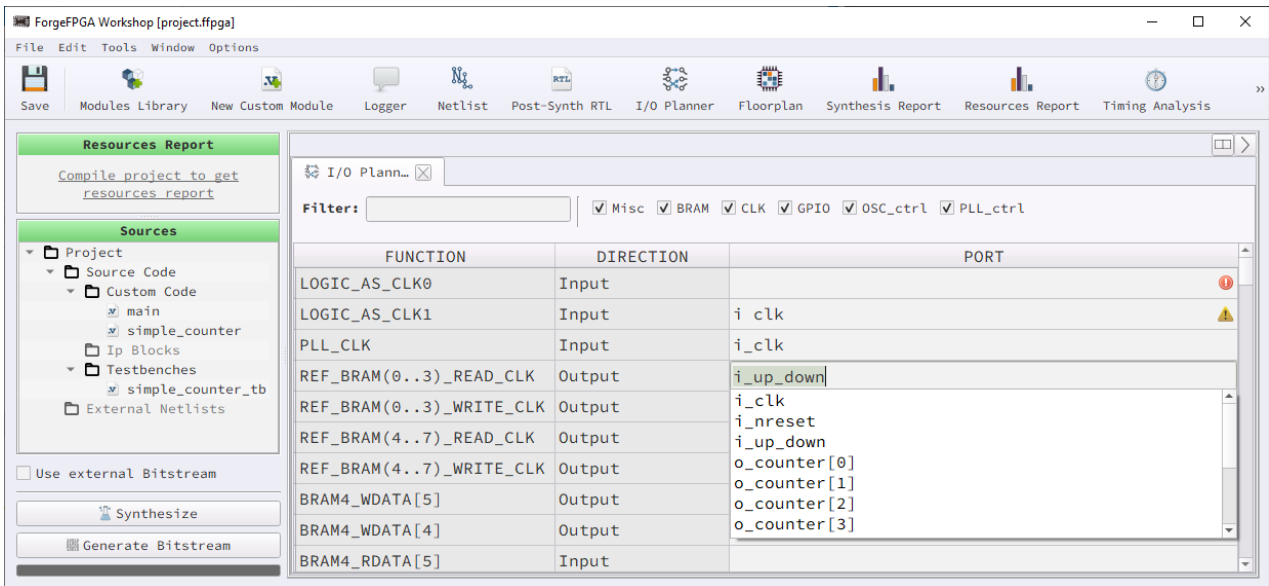

### I/O Planner

For easier navigation, use the additional controls to filter out the desired data.

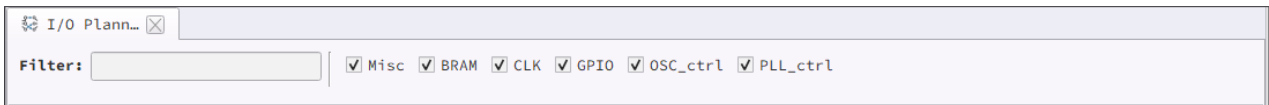

### Filter controls

You can also clear or import/export the port data (.txt or .csv formats) via main menu, *Tools* → *I/O Planner*, or using the table's context menu.

## Synthesis Report

After performing the synthesis of your current design, a new report is generated. This report shows the number of primitive objects used to represent the design in the generated [netlist](#).

To open the *Synthesis Report* window, click the corresponding button on the toolbar or reach the main

menu *Window* → *Synthesis Report*.

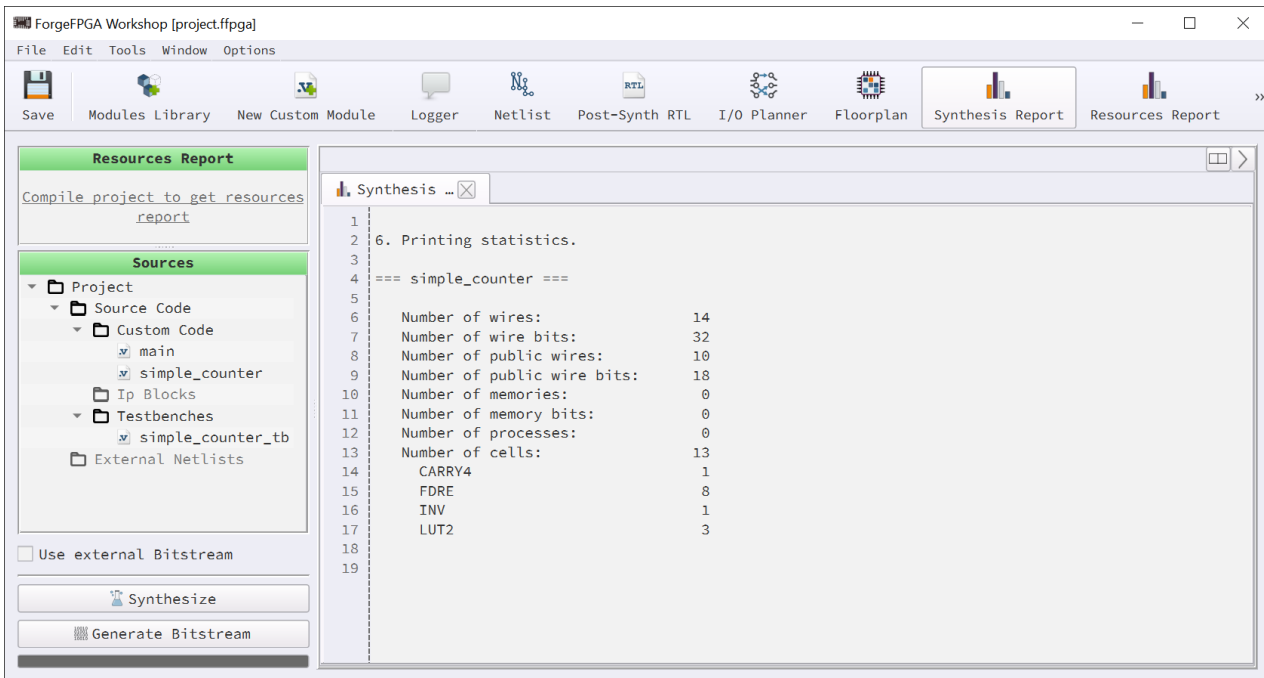

### Synthesis Report

## 2.5.7 Generating Bitstream

To prepare your design to be sent to the device, you need to perform the place-and-route and the bitstream generation procedures. You can do this once the [netlist](#) and bitstream files are successfully generated. Place-and-route takes the elements of the synthesized netlist and maps its primitives to FPGA physical resources. To receive bitstream data, click the *Generate Bitstream* button in the bottom left corner of *FPGA Editor* or from the main menu, *Tools* → *Generate Bitstream*.

You can check the *Bitstream Log* tab on the *Messages* panel to inspect the background steps after you click *Generate Bitstream*. In the background, the software automatically performs technology mapping, clustering and floor planning, placement and optimization, routing and resource calculation. If the issue occurs in any of these steps, the bitstream generation will be incomplete, and you will see outcome on the [Messages](#) panel.

The generated bitstream is a hex file which, if generated correctly, you can further use for debugging your design. Read more about the [chip/flash procedures](#) and where to find them in section [2.2.6 Debugging Controls](#).

After bitstream generation is completed, you can see the generated info for the tools described later in this section.



## Floorplan

The results of the place-and-route procedure are visualized in the *Floorplan* tool. Check how the primitives from the [netlist](#) are placed and interconnected, as well as how the I/O ports are mapped to the internal blocks and GPIOs. Launch the tool via the toolbar or *Window* section in the main menu. Use the bottom toolbar controls to take a closer look and navigate inside the tool.

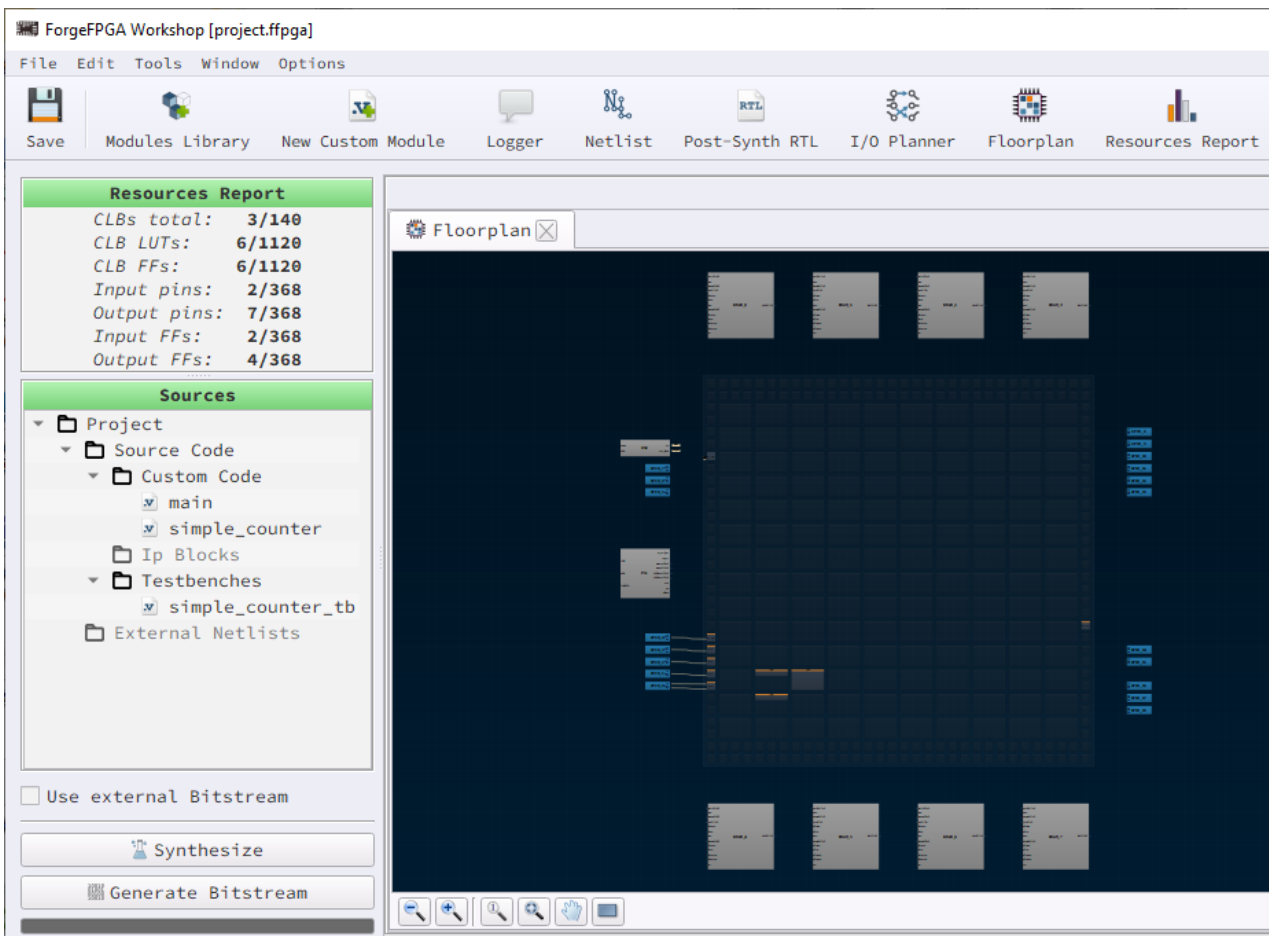

Floorplan

Click the internal component to see its details on the block configuration info panel. Also, see the components and connections color scheme by clicking the *Legend box* icon at the right bottom.

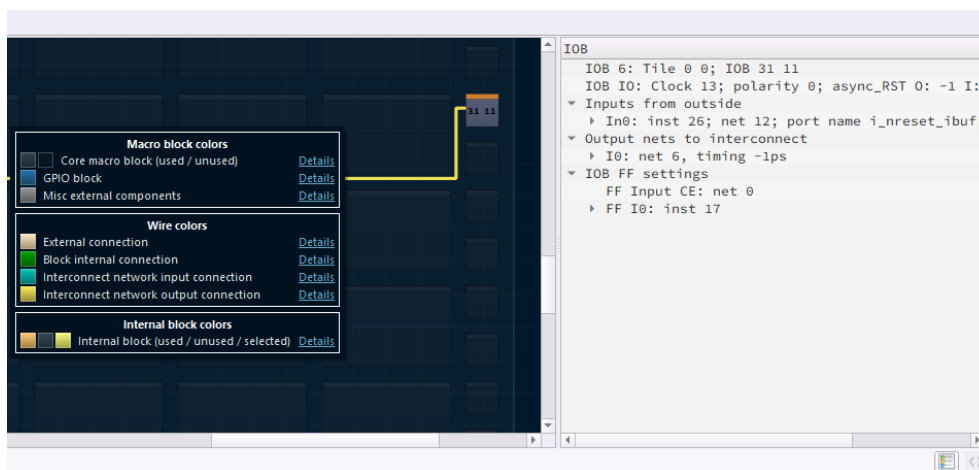

Informational elements

In addition, you can manually upload the configurations by accessing *Load custom PNR* in the main menu, *Tools* → *Floorplan*.

## Resources Report

After you perform the bitstream generation procedure, a full report of the used resources is generated. This report shows the amount of CLBs, FFs, I/Os, and LUTs used for the design synthesis. You can also see the list of utilized resources on the [control panel](#). To open the *Resources Report* window, click the corresponding button on the toolbar or reach the main menu, *Window* → *Resources Report*.

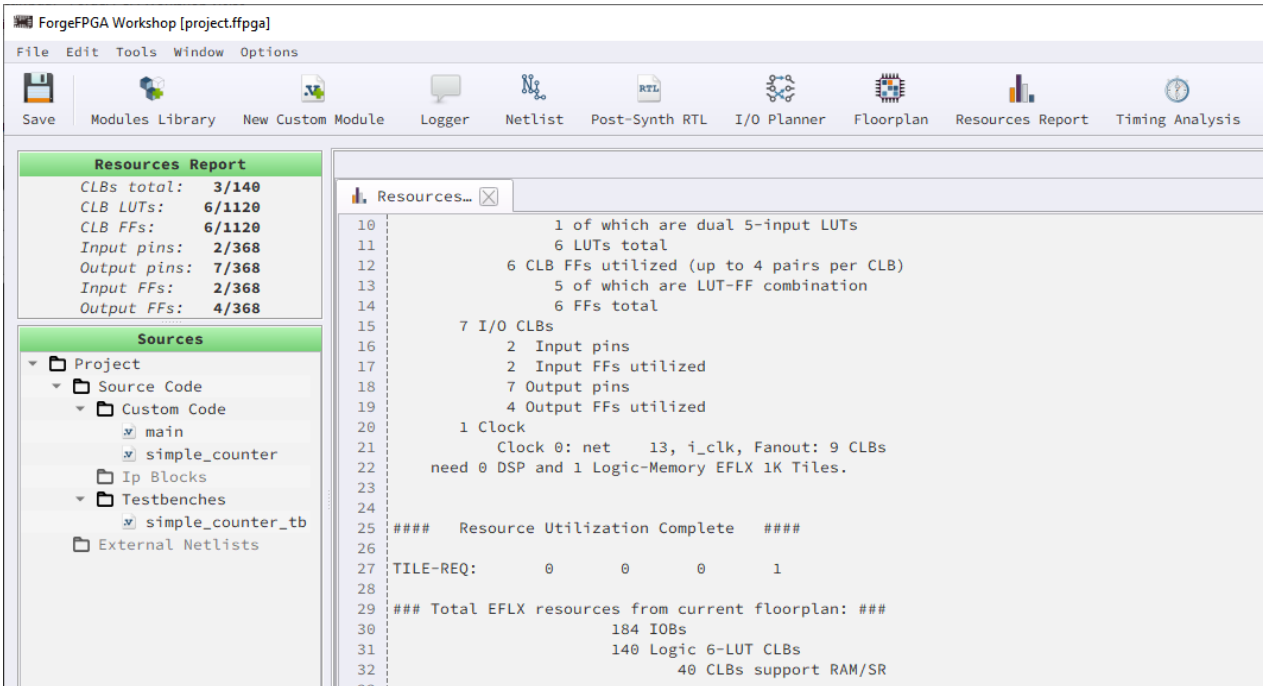

The screenshot shows the ForgeFPGA Workshop interface with the Resources Report window open. The report displays the following utilization statistics:

Resource	Used	Total
CLBs total	3	140
CLB LUTs	6	1120
CLB FFs	6	1120
Input pins	2	368
Output pins	7	368
Input FFs	2	368
Output FFs	4	368

The detailed report text includes:

```
10 1 of which are dual 5-input LUTs
11 6 LUTs total
12 6 CLB FFs utilized (up to 4 pairs per CLB)
13 5 of which are LUT-FF combination
14 6 FFs total
15 7 I/O CLBs
16 2 Input pins
17 2 Input FFs utilized
18 7 Output pins
19 4 Output FFs utilized
20 1 Clock
21 Clock 0: net 13, i_clk, Fanout: 9 CLBs
22 need 0 DSP and 1 Logic-Memory EFLX 1K Tiles.
23
24 ##### Resource Utilization Complete #####
25
26 TILE-REQ: 0 0 0 1
27
28 ##### Total EFLX resources from current floorplan: ###
29 184 IOBs
30 140 Logic 6-LUT CLBs
31 40 CLBs support RAM/SR
32
33
```

## Resources Report

## Timing Analysis

The tool is designed to extract timing and check for any timing violations associated with any of the internal registers. The results show whether all set-up, hold, and pulse-width time is being met.

You can find the tool on the toolbar, or by clicking *Window* → *Timing Analysis* in the main menu.

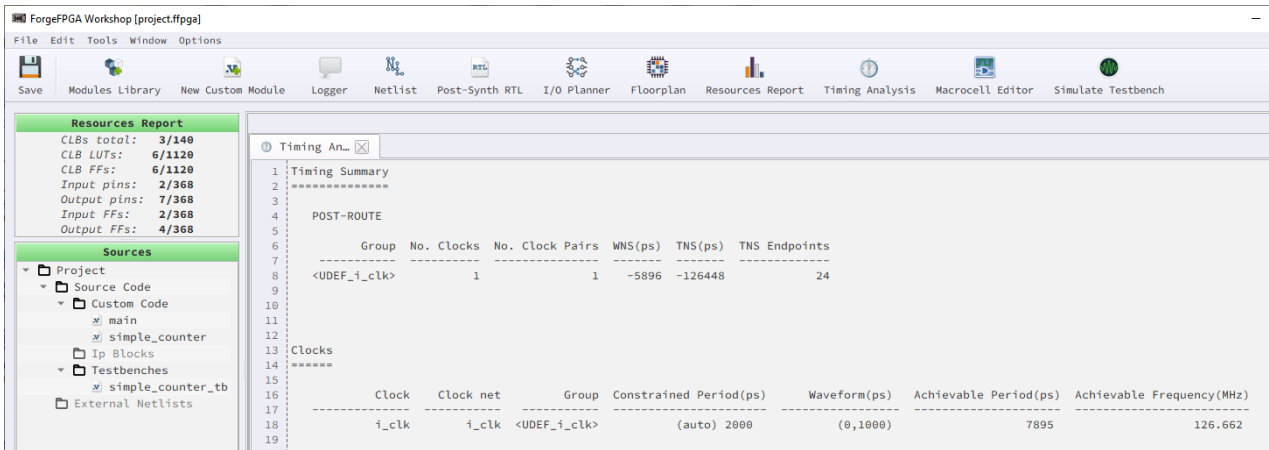

## Timing Analysis

### 2.5.8 Project directory structure

Once you create a project, the directory appears in the specified location. It contains the project file and *build* folder (read later in this section) and will also store the modules and netlists, which you add or import in *FPGA Editor* to the *Sources* tree. The changes made to the sources will synchronize between the *FPGA Editor* and the file on disk.

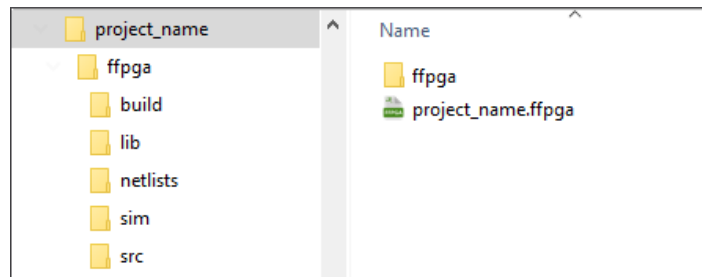

## FPGA project structure

Use the *Open Containing Folder* feature in the context menu to quickly locate the file on disk.

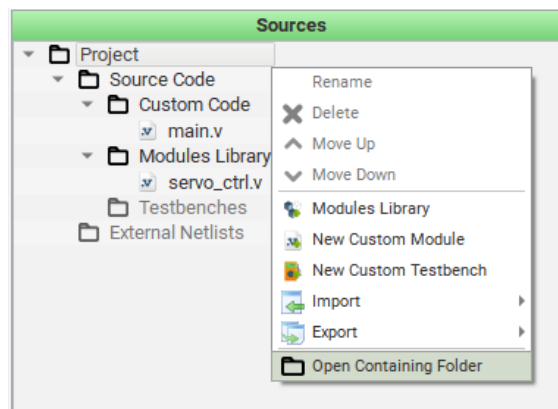

## Check Sources file location

As soon as we perform the procedures ([synthesis](#) or [bitstream generation](#)), the certain files are

generated to the *build* folder. The list of generated files depends on the performed procedures. Below, you can see the description of the most important files present in the *build* folder:

- ▶ *FPGA\_bitstream\_AXI.log* — contains the generated bitstream that represents your project's logic. This file is used while interacting with the development hardware upon performing the [chip/flash procedures](#)
- ▶ *io\_spec\_in.txt* — lists the I/O ports specification added in the *I/O Planner*, which is created right upon clicking *Generate Bitstream*
- ▶ *PNR\_IO.log* — I/O ports mapping file generated after successful bitstream generation procedure
- ▶ *netlist.edif* — the result of Yosys data processing, describing the components and connectivity within the source design. You can also import an external netlist from another software/synthesis tool
- ▶ *PNR\_PACK\_PLACE.log* — source data for building a floorplan
- ▶ *post\_synth\_results.v* — Yosys output data in the Verilog code format
- ▶ *resource-utilization-report.log* — information about the resources amount required for your design
- ▶ *simulation* — folder containing simulation results

### 2.5.9 Simulation

Simulation allows you to verify the overall functionality of the FPGA design and its response to different inputs without the need for physical hardware.

*FPGA Editor* works in correspondence with 3rd party software for simulating the testbench, called Icarus Verilog, and for verifying the functionality of the design by viewing simulation results we use GTKWave. Please refer to the [How to](#) section for the installation and quick start guide of the additional software.

#### Writing a testbench

To work with *Simulation* you should have a testbench module for the FPGA design. You can add a testbench from the [Modules Library](#), or import a module from the main menu, *File* → *New Custom Testbench*. *FPGA Editor* opens the new testbench module with a few lines of code to act as a guideline

for writing the testbench.

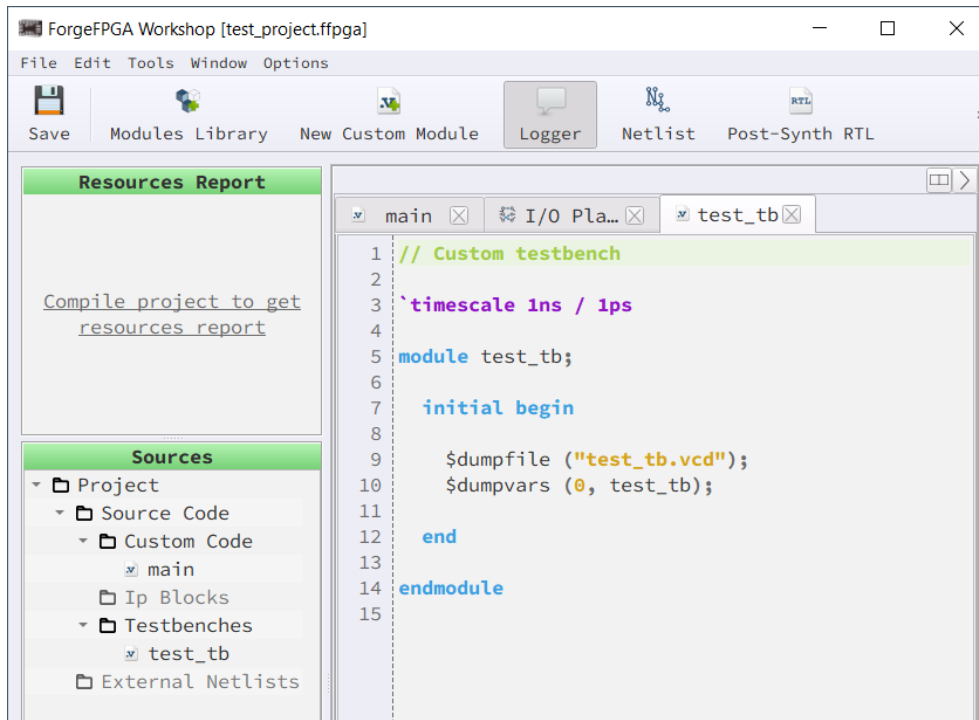

Custom Testbench example

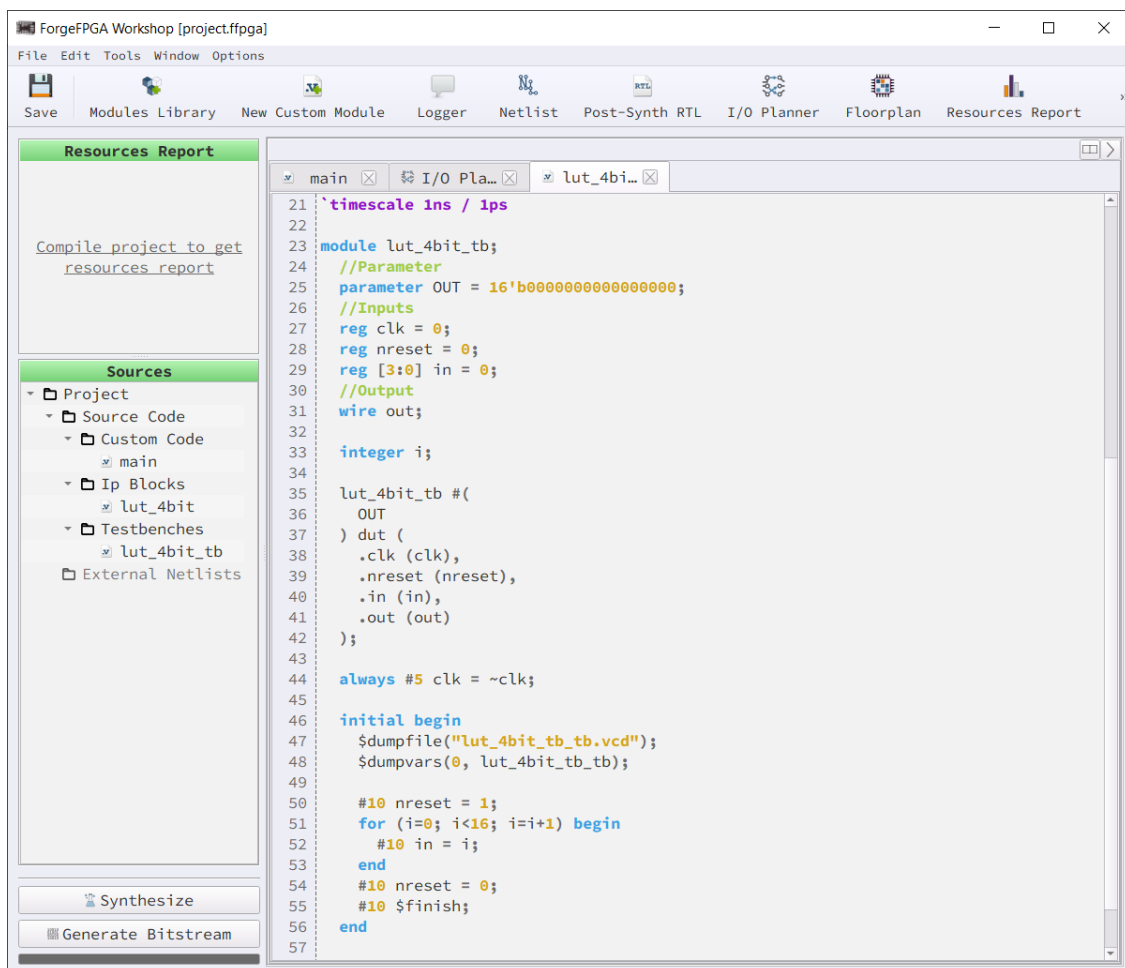

4-bit LUT Testbench example from Modules Library

## Simulating a testbench

After adding the testbench, click the *Simulate Testbench* button on the toolbar to launch the Icarus Verilog and GTKWave or from the main menu, *Tools* → *Simulation*. The simulation stage handled by Icarus Verilog is performed in the background, while the GTKWave has a visual representation. If the selected testbench is correct and contains no syntax errors, then the GTKWave software will launch automatically. In case it does not launch, check the *Messages* panel for any syntax related issues in the testbench code and make necessary changes.

*FPGA Editor* ensures you can keep working from the last saved state of simulation results. Once you make necessary configurations (e.g. add signals, adjust their graphical representation, etc.), save the progress in the GTKWave tool. Next time you simulate the same testbench, you will start from where you left off the previous time.

## 2.5.10 Macrocell Editor

*Macrocell Editor* is a tool which allows you to create the desired circuit in a schematic view. Launch the tool by clicking the corresponding button on the toolbar, or go to main menu, *Window* → *Macrocell Editor*.

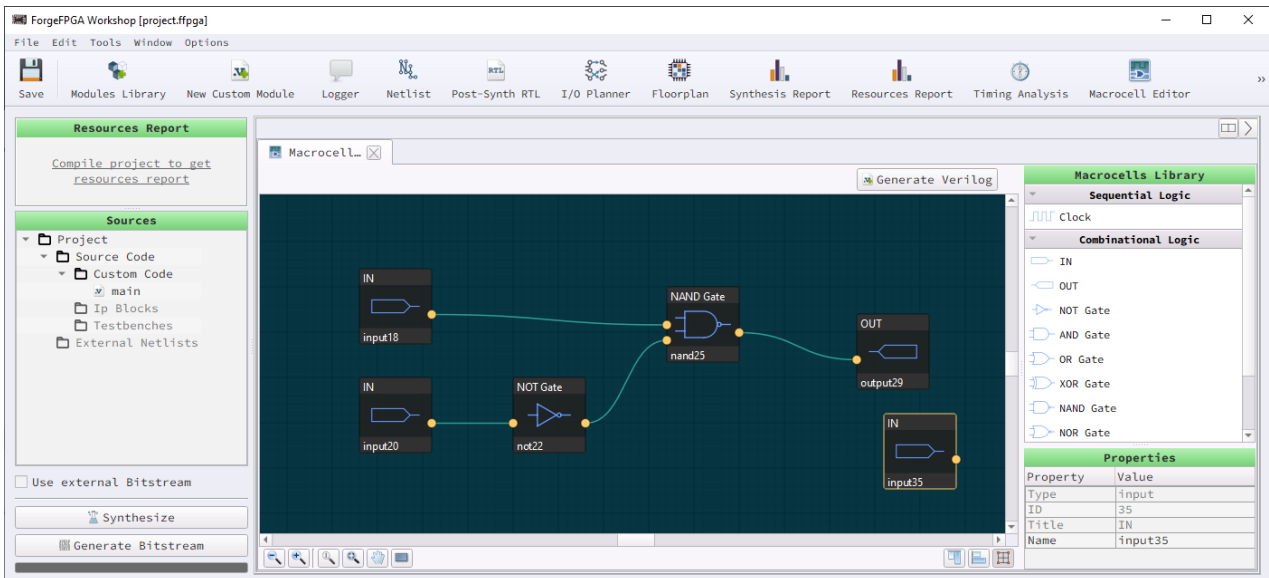

**Macrocell Editor**

The *Macrocells Library* panel contains the list of components, which you can use for circuit design. Click the desired component from the library and then the work area to add it to the circuit.

The *Properties* panel shows the details for one selected macrocell or connection. The *Name* field is

editable (double-click the field or the macrocell).

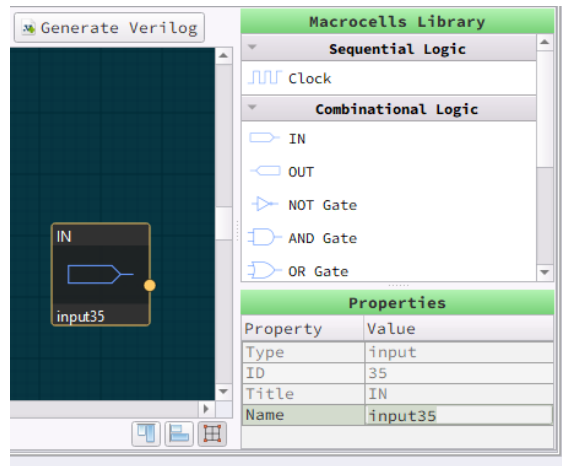

**Macrocells Library and Properties panels**

Clicking two ports creates the connection between the macrocells.

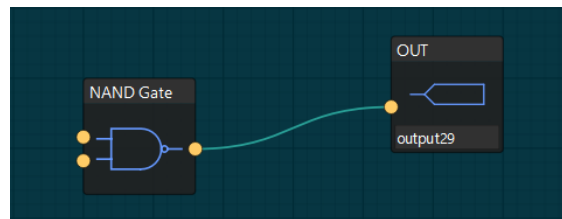

**Setting a connection**

To generate the Verilog code based on the created design, click the *Generate Verilog* button. The created Verilog code is listed as *mcm\_generated* under the *Custom Code* section of the [control panel](#). You can use this code for the synthesis along with other modules added in the design.

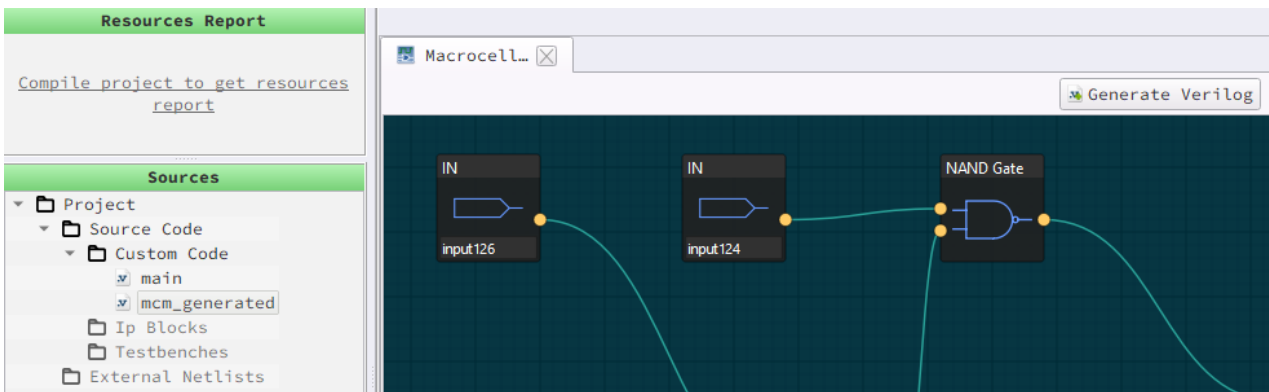

**Verilog generation**

## 2.5.11 PLL Calculator

The PLL Calculator helps to determine the parameters for the desired output signal. You can access it through the *FPGA Editor* → *PLL Calculator*.

Set the *input frequency (FREF)* and configure all four parameters (*REFDIV*, *FBDIV*, *POSTDIV1*, and *POSTDIV2*) in the calculator to achieve the desired *output frequency (FOUT)*. Formulas for calculations and their ranges are provided above the value sliders. Results exceeding the range are highlighted in red, while those within the range are displayed in black.

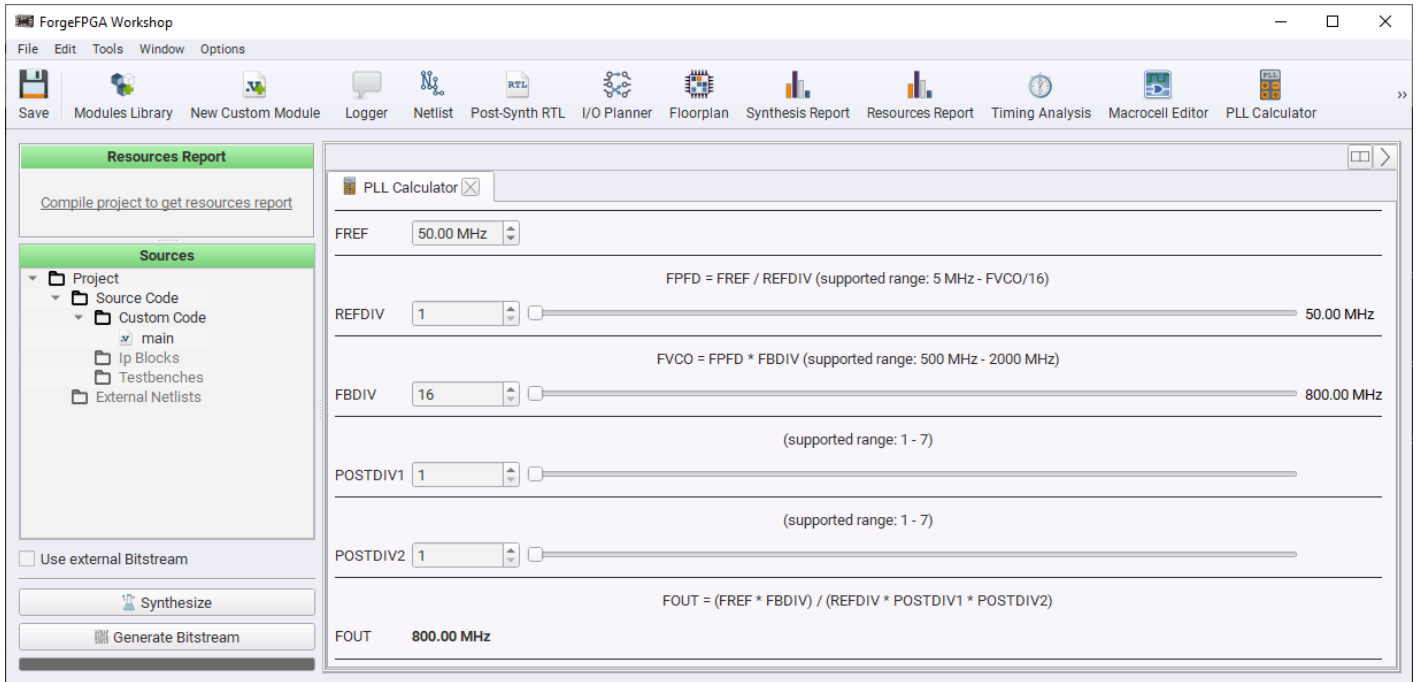

**PLL Calculator**



## 2.5.12 Settings

The *ForgeFPGA Workshop Settings* window allows you to adjust multiple project and user settings.

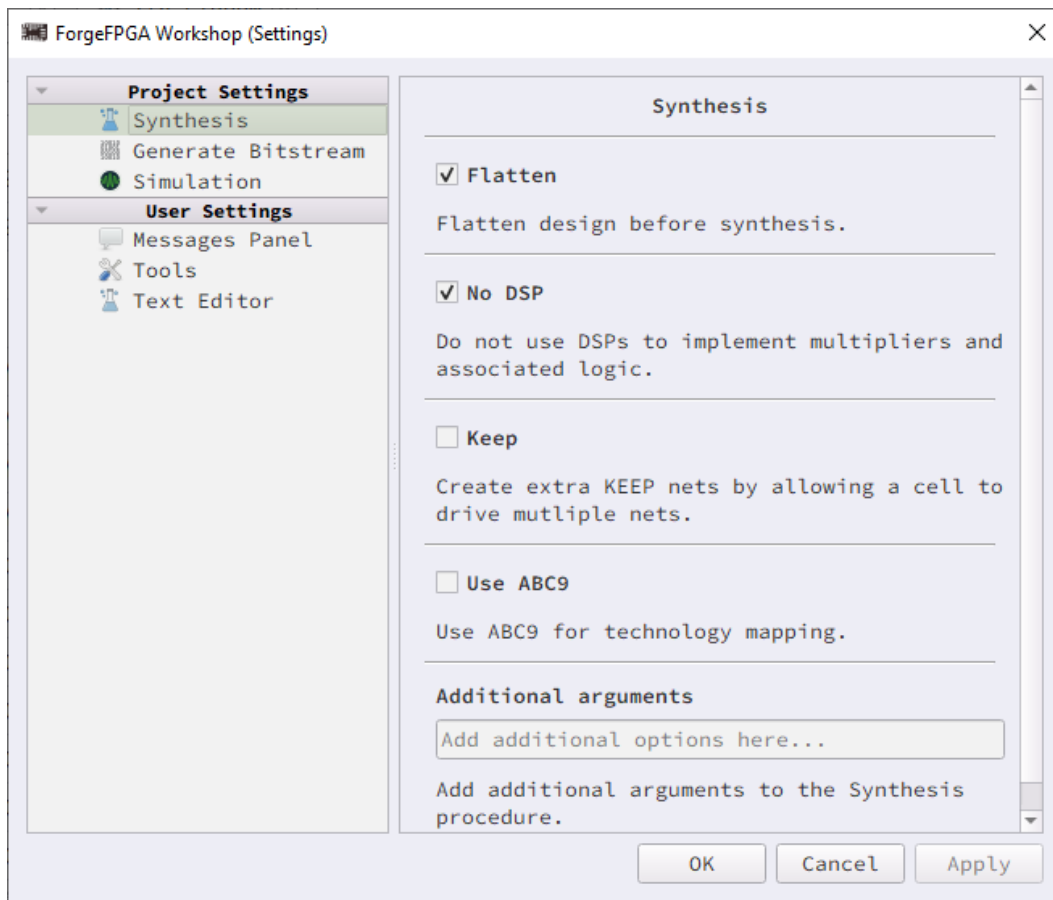

**ForgeFPGA Workshop Settings**

**Note:** Changes you make in the *Project Settings* category apply to the project you are currently working on. Adjustments made in the *User Settings* section have a global impact, ensuring consistency across all FPGA-related projects on a particular device. If you switch to another computer, these settings will either be reset to default values or adapted to the configurations of that specific computer.

### Project Settings

Within the *Project Settings* section, you can find a range of options to optimize your workflow. These options include:

- *Synthesize* — enables you to flatten your design before synthesis, manage DSP usage, generate additional KEEP nets, or control the use of ABC9. You can also add additional arguments to the synthesis procedure
- *Generate Bitstream* — involves several settings and processes. These include *High-Density IO Packing*, *High-Density Packing Logic*, *Clock-Concurrent Optimization (CCopt)*, the *Place-and-Trial routing*, adjustments to the *Place-and-Trial routing iteration count*, and the *Maximum Routing Iterations parameter*. Additional arguments can be also added to the Generate Bitstream procedure

- ▶ *Simulation* — allows you to configure the Wavedump output format to either .vcd or .fst

## User Settings

In the *User Settings* category, you can customize:

- ▶ *Messages Panel* — offers you the flexibility to decide whether to clear *Synthesis/Bitstream Log* each time you start a new procedure
- ▶ *Tools* — gives you the ability to modify the accessibility settings for the *Icarus Verilog tool* and the *GTKWave tool*. Here, you can either specify the path to the folders for detection or choose Autodetect to let the software locate the files automatically. You can also switch to using the system environment

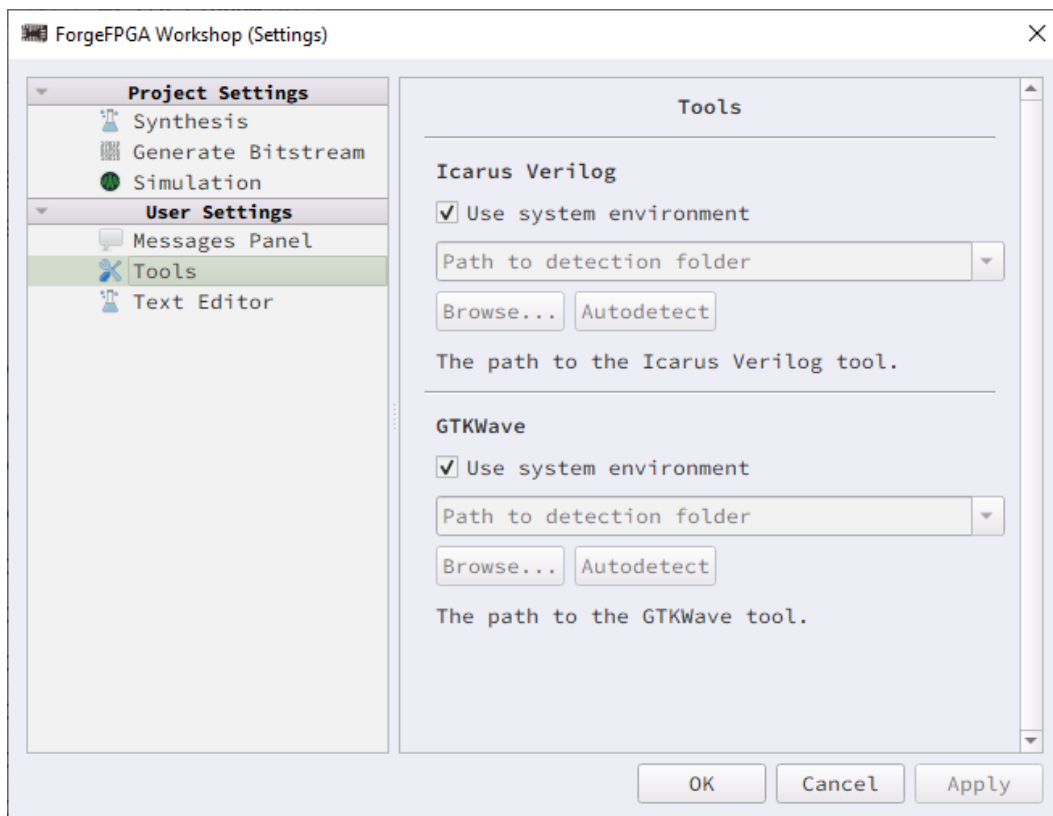

**ForgeFPGA Workshop Settings Tools Tab**

- ▶ *Text Editor* — allows you to define the number of spaces in a tab for all text editors

Follow the instructions provided in the descriptions of the options to avoid errors and improve your design.

# 3 Devices

The *Go Configure Software Hub* allows project debugging using diverse hardware platforms to provide communication between a specific chip and the software. Depending on the device you choose for your project, the software adapts to support different platforms.

In this chapter, you will be introduced to the supported development platforms tailored for *GreenPAK*, *ForgeFPGA*, and *PowerPAK* devices. Each platform will be presented with an overview, functional descriptions, and insights into its software representation.

# 3.1 GreenPAK devices

## 3.1.1 GreenPAK Advanced Development Platform

- ▶ Programming and emulation for *GreenPAK* devices
- ▶ 18 individually configurable Test Points (TPs):
  - Analog, digital and I2C generators support
  - Onboard LED state indication
  - Pull-up, Pull-down, GND, VDD, Hi-Z
  - Programmable software button
  - Floating hooks on each Test Point for oscilloscope connection
- ▶ Dual VDD IC's support
- ▶ 20-pin socket adapter support
- ▶ USB interface for power and communication (mini-B connector)
- ▶ In-System Debugging (ISD) and In-System Programming (ISP) functionality
- ▶ Software controlled configurable pin header for user schematic integration and signal monitoring (expansion connectors)

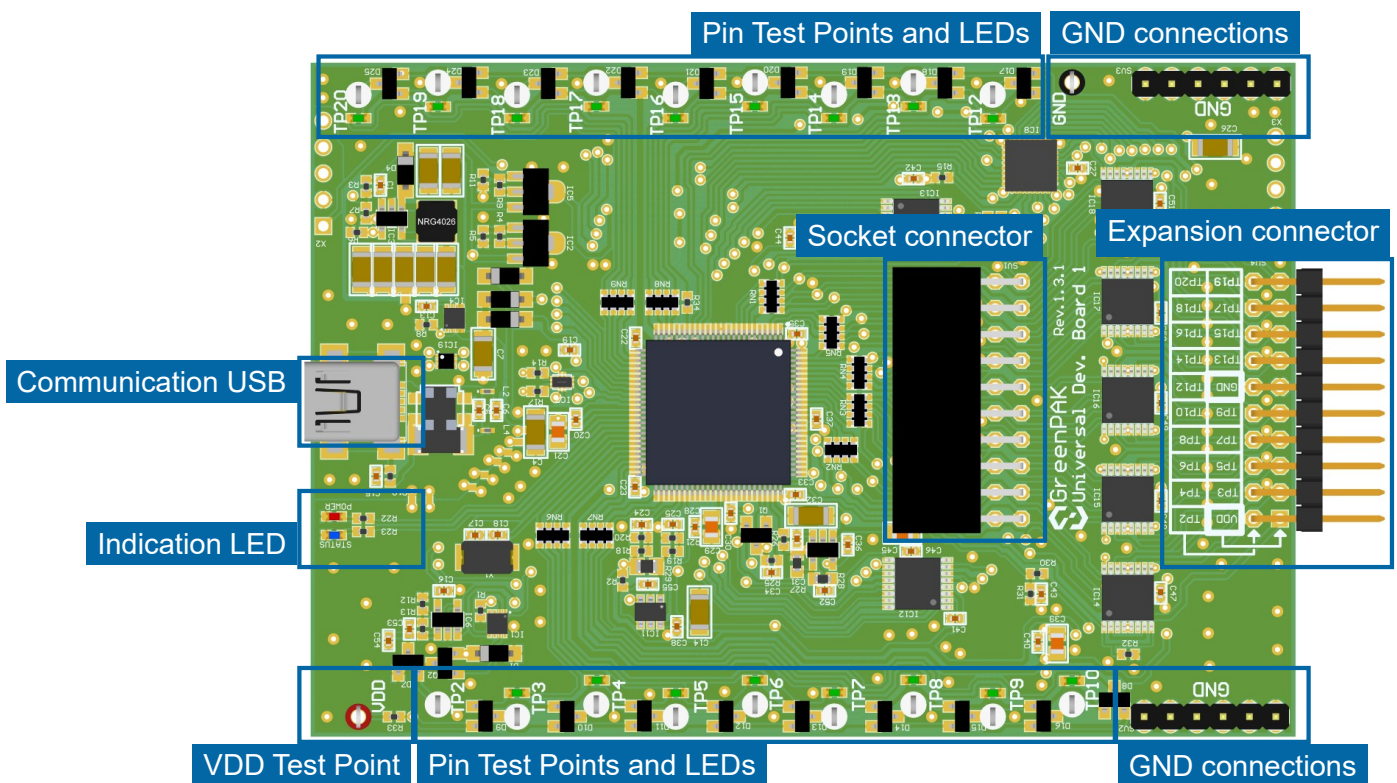

**GreenPAK Advanced Development Platform**

The *GreenPAK Advanced Development Platform Debugging Controls* User Interface includes the following sections:

- Debug Configuration
- Device selector
- Emulation
- Emulation(sync)
- Test Mode
- Read
- Program
- Project data window
- Generator controls
- Expansion connectors
- Power source selector
- TP map
- LEDs ON and LEDs OFF
- Info details

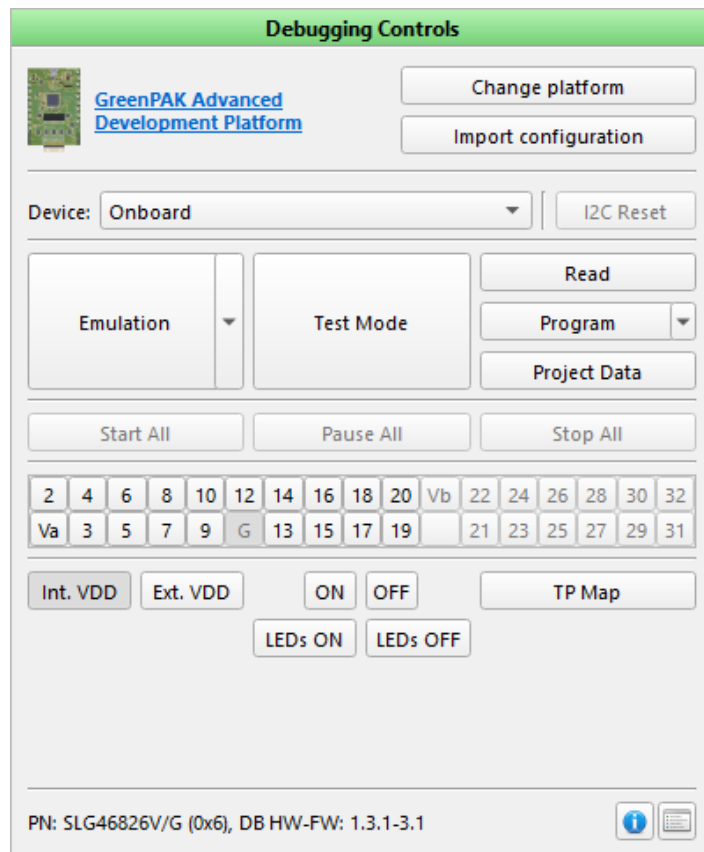

**GreenPAK Advanced Development Platform controls**

Find a comparison of the controls available on different *GreenPAK* boards in the appendix, section 6.3 Debugging Controls feature availability.

### 3.1.2 GreenPAK DIP Development Platform

- ▶ Programming and emulation for *GreenPAK* devices
- ▶ 18 individually configurable Test Points (TP):
  - Pull-up, Pull-down, GND, VDD, Hi-Z
  - Programmable software button
- ▶ Dual VDD IC's support
- ▶ DIP adapter support
- ▶ USB interface for power and communication (micro-B connector)
- ▶ In-System Debugging (ISD) and In-System Programming (ISP) functionality
- ▶ Software controlled configurable dual pin header for user schematic integration and signal monitoring (expansion connectors)

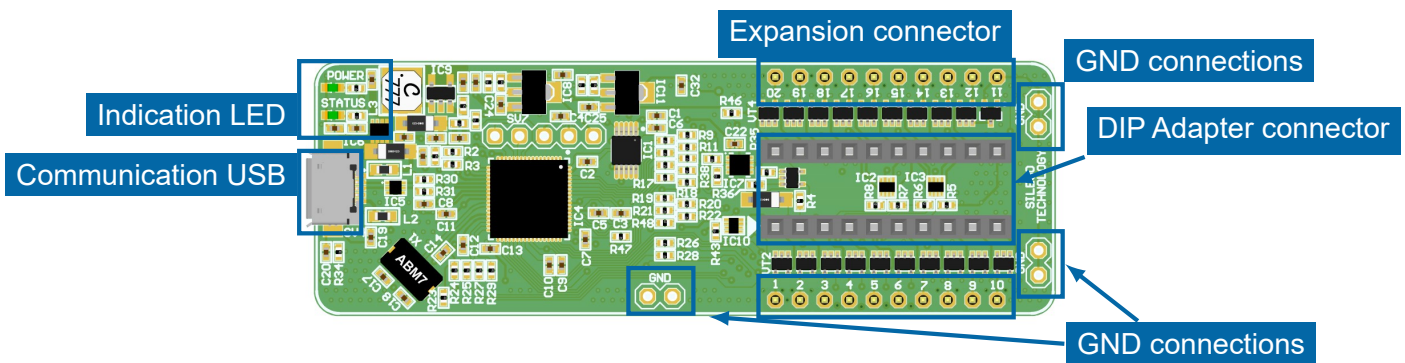

**GreenPAK DIP (Dual In-Line Package) Development Platform**

The *GreenPAK DIP Development Platform Debugging Controls* User Interface includes the following sections:

- |                     |                     |                       |
|---------------------|---------------------|-----------------------|
| Debug Configuration | Test Mode           | Expansion connectors  |
| Device selector     | Read                | Power source selector |
| I2C Reset           | Program             | TP map                |
| Emulation           | Project data window | LEDs ON and LEDs OFF  |
| Emulation(sync)     | Generator controls  | Info details          |

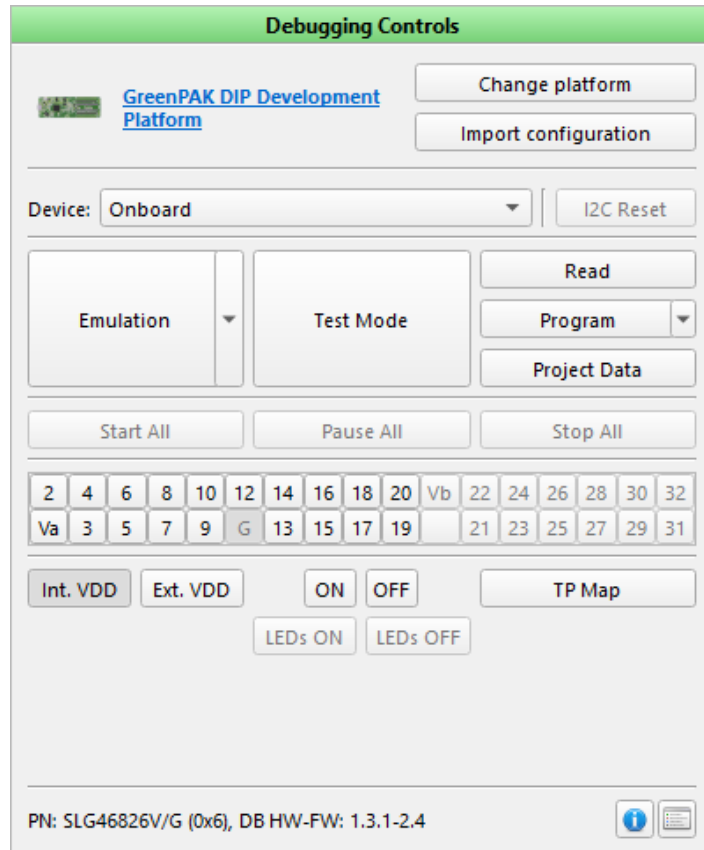

**GreenPAK DIP Development Platform controls**

Find a comparison of the controls available on different *GreenPAK* boards in the appendix, section 6.3 Debugging Controls feature availability.

### 3.1.3 GreenPAK Lite Development Platform

- ▶ Programming and emulation for *GreenPAK* devices
- ▶ 18 individually configurable Test Points (TP):
  - Onboard LED state indication
  - Pull-up, Pull-down, GND, VDD, Hi-Z
  - Programmable software button
  - Four floating hooks for oscilloscope connection
- ▶ Dual VDD IC's support
- ▶ DIP and socket adapters support
- ▶ USB interface for power and communication (USB-C connector)
- ▶ In-System Debugging (ISD) and In-System Programming (ISP) functionality
- ▶ Software controlled configurable dual pin header for user schematic integration and signal monitoring (expansion connectors)



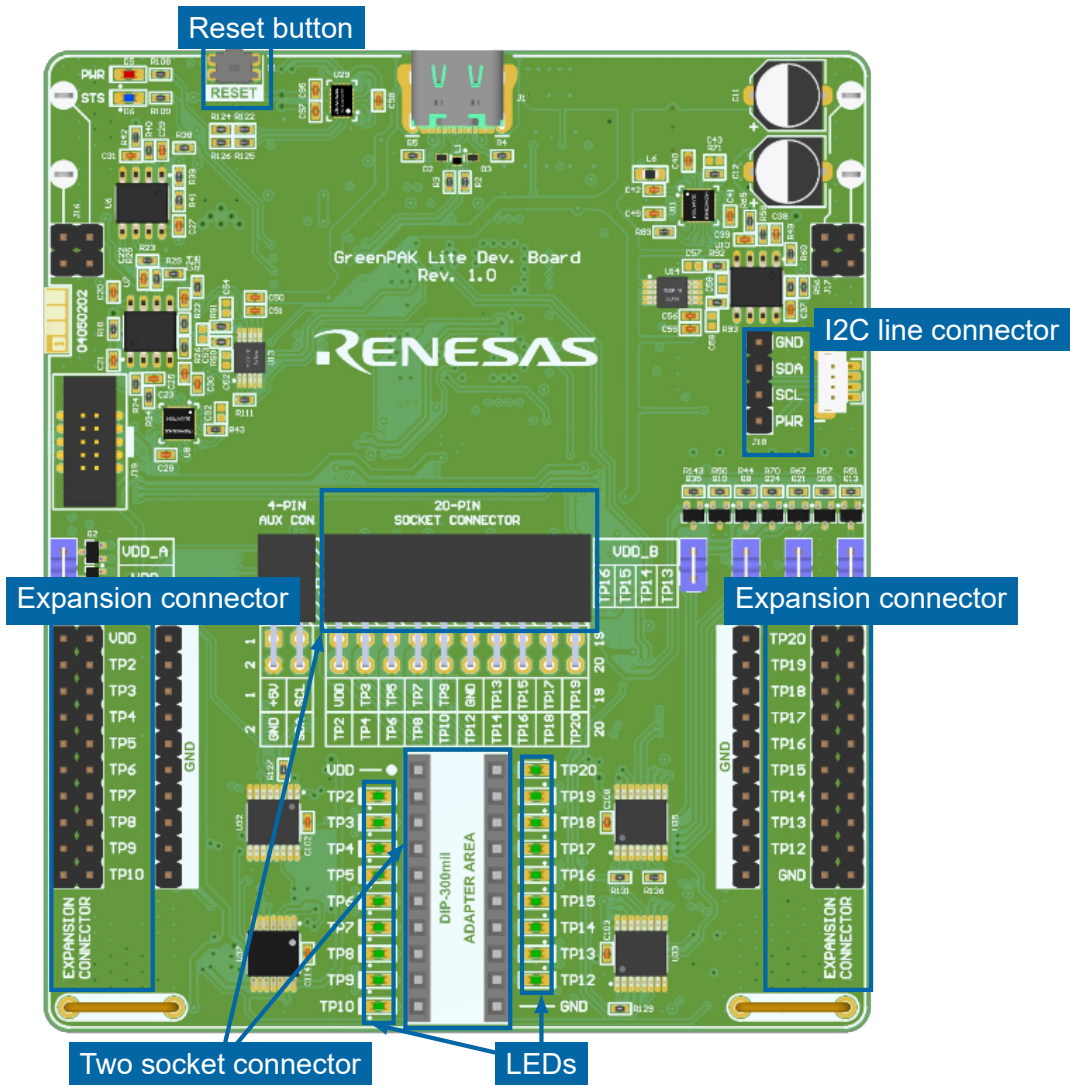

**GreenPAK Lite Development Platform**

The *GreenPAK Lite Development Platform Debugging Controls* User Interface includes the following sections:

- |                       |                       |                        |
|-----------------------|-----------------------|------------------------|
| Debug Configuration   | Test Mode             | TP map                 |
| Device selector       | Read                  | LEDs ON and LEDs OFF   |
| External device modes | Program               | Voltage level controls |
| I2C Reset             | Project data window   | Info details           |
| Emulation             | Expansion connectors  |                        |
| Emulation(sync)       | Power source selector |                        |

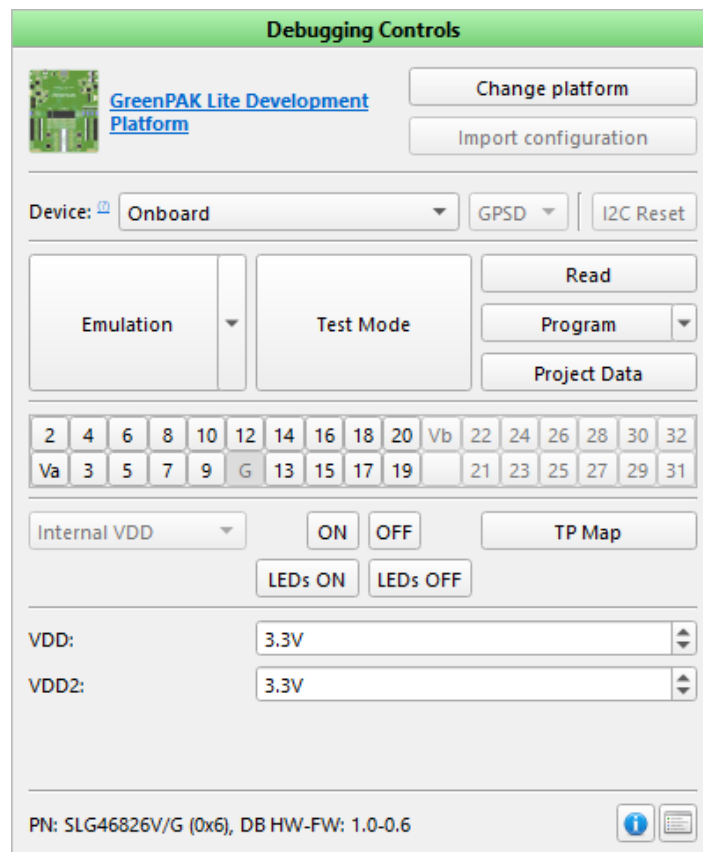

**GreenPAK Lite Development Platform controls**

Find a comparison of the controls available on different *GreenPAK* boards in the appendix, section 6.3 Debugging Controls feature availability.

### 3.1.4 GreenPAK Serial Debugger

- ▶ In-System Programming for Multiple Programmable *GreenPAK* devices (e.g. SLG46824, SLG46826, SLG47004)
- ▶ In-System Debugging for reading, emulating and debugging *GreenPAK* devices
- ▶ USB interface for power and communication (micro-B connector)
- ▶ 4-pin connector with I2C interface
- ▶ Internal and external power supply for I2C

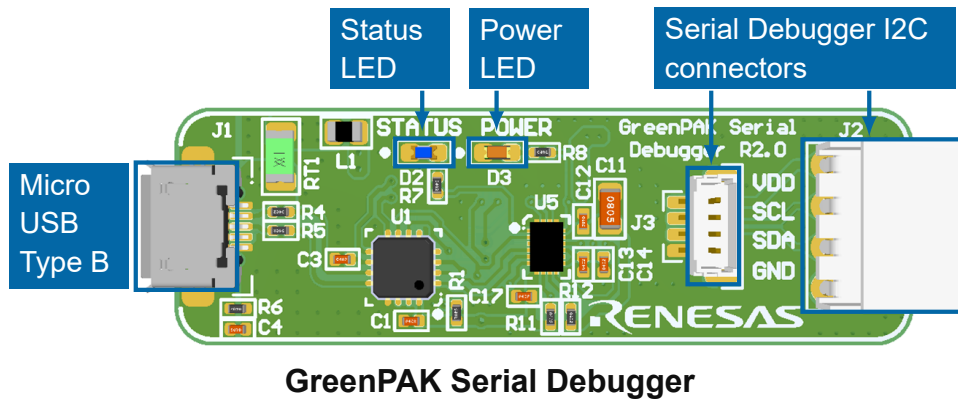

The *GreenPAK Serial Debugger Platform Debugging Controls* User Interface includes the following sections:

Debug Configuration	Emulation(sync)	Project data window
Device selector	Test Mode	Power source selector
I2C Reset	Read	Voltage level controls
Emulation	Program	Info details

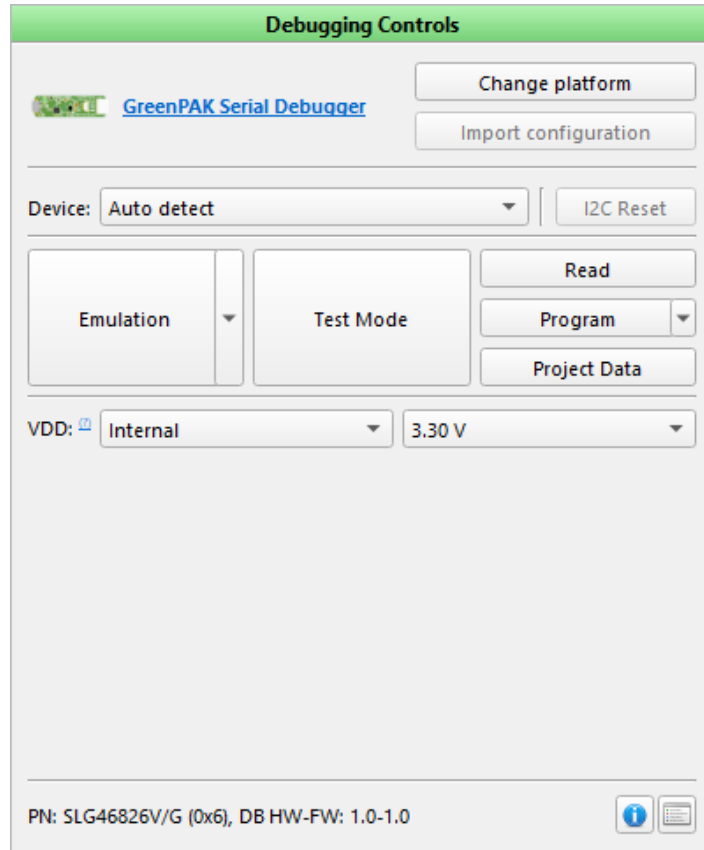

**GreenPAK Serial Debugger Platform controls**

Find a comparison of the controls available on different *GreenPAK* boards in the appendix, section 6.3 *Debugging Controls feature availability*.

## 3.1.5 Connecting external GreenPAK

### Advanced, DIP, or Lite platforms

- ▶ Connect the socket with an external chip to a *Development Board* via pins:
  - Corresponding I2C pins (*SCL*, *SDA*)
  - *VDD* pin
  - *GND* pin

For the *DIP/Advanced/Lite Development Board*: connect a socket with an external chip to the *Expansion Connector* pins:

- ▶ Disconnect the Onboard chip to proceed with the external chip
- ▶ Start the *Go Configure Software Hub* and select the Part Number of the connected external chip
- ▶ Start the *Debug tool* and select the *Development Platform*
- ▶ Select the *Device address* (used by default for an empty chip) or the corresponding address programmed to the chip **Note:** If an external socket is connected to a development board correctly and the proper *Device address* is selected, a chip is detected either after clicking *Update chip info* or automatically after starting any chip operation

Once all steps are completed, the debugging controls become active.

**Note:** *Ext. VDD (Va)* expansion can be disabled if the voltage is applied to an external *VDD* port. The *expansion connector* will automatically disconnect, and a warning message will be displayed if *Emulation/Test mode* operations for a chip with applied external voltage are running.

### Serial Debugger platform

- ▶ Connect a socket with an external chip to a *Development Board* via ECs:
  - Corresponding I2C pins (*SCL*, *SDA*)
  - *VDD* pin
  - *GND* pin
- ▶ Connect a chip with wires to the *Serial Debugger* pins (*VDD*, *CLK*, *SDA*, *GND*):
- ▶ Start *Go Configure Software Hub* and select the Part Number of the connected external chip
- ▶ Start the *Debug tool* and select the *Serial Debugger platform*
- ▶ Select 0001b for the *Device address* (used by default for an empty chip) or a corresponding address programmed to the chip
- ▶ Specify *VDD* configuration:

- *Internal* — chip is powered from a *Serial Debugger* board
- *External* — chip is powered from an external power source

Once all steps are completed, the debugging controls become active.

## 3.2 ForgeFPGA devices

### 3.2.1 ForgeFPGA™ Advanced Development Boards

- ▶ Programming and emulation for *ForgeFPGA* devices
- ▶ 80 digital configurable Test Points (TPs):
  - 64-channel high-speed digital generators (up to 200 MS/s)
  - Programmable software button (VDD, GND, Hi-Z)
- ▶ 32 configurable constant voltage sources (8 in Rev. 1.0)
- ▶ 64-channel digital Logic Analyzer (up to 200 MS/s)
- ▶ Two PCIe connector for socket adapter
- ▶ USB 3.0 interface for communication (USB-C connector)
- ▶ External 12V power supply

**Note:** The *ForgeFPGA Advanced Development Board Rev. 2.0* is now accessible alongside the platform revision described above. Make sure you select the appropriate platform revision while working with [Debug tools](#). You can load the preset configurations between the *ForgeFPGA Advanced Development Board* and *ForgeFPGA Advanced Development Board Rev. 2.0* (currently excluding *Logic Analyzer* settings) using the [Import configuration](#) option on the [Debugging Controls](#).

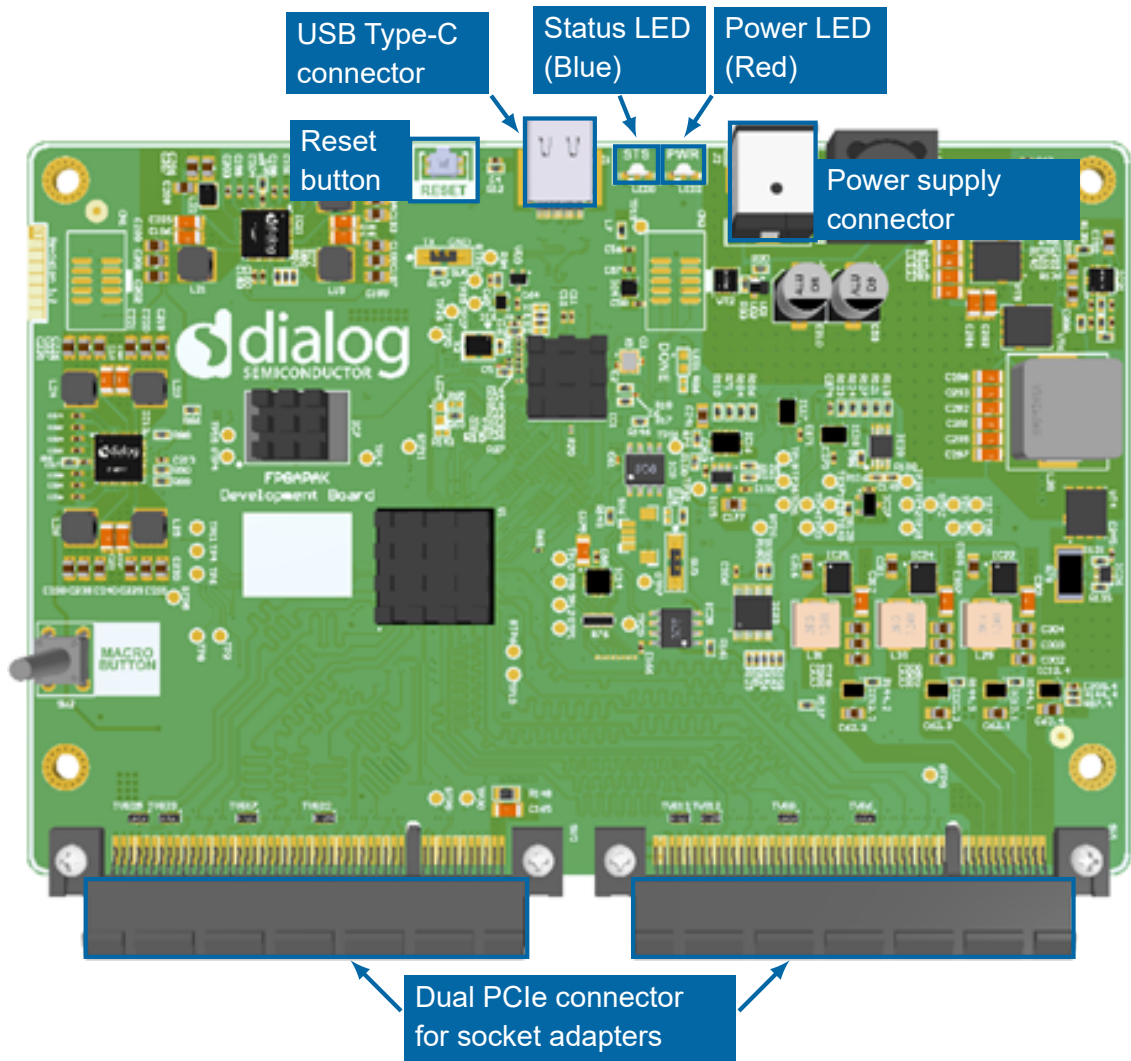

**ForgeFPGA Advanced Development Board**



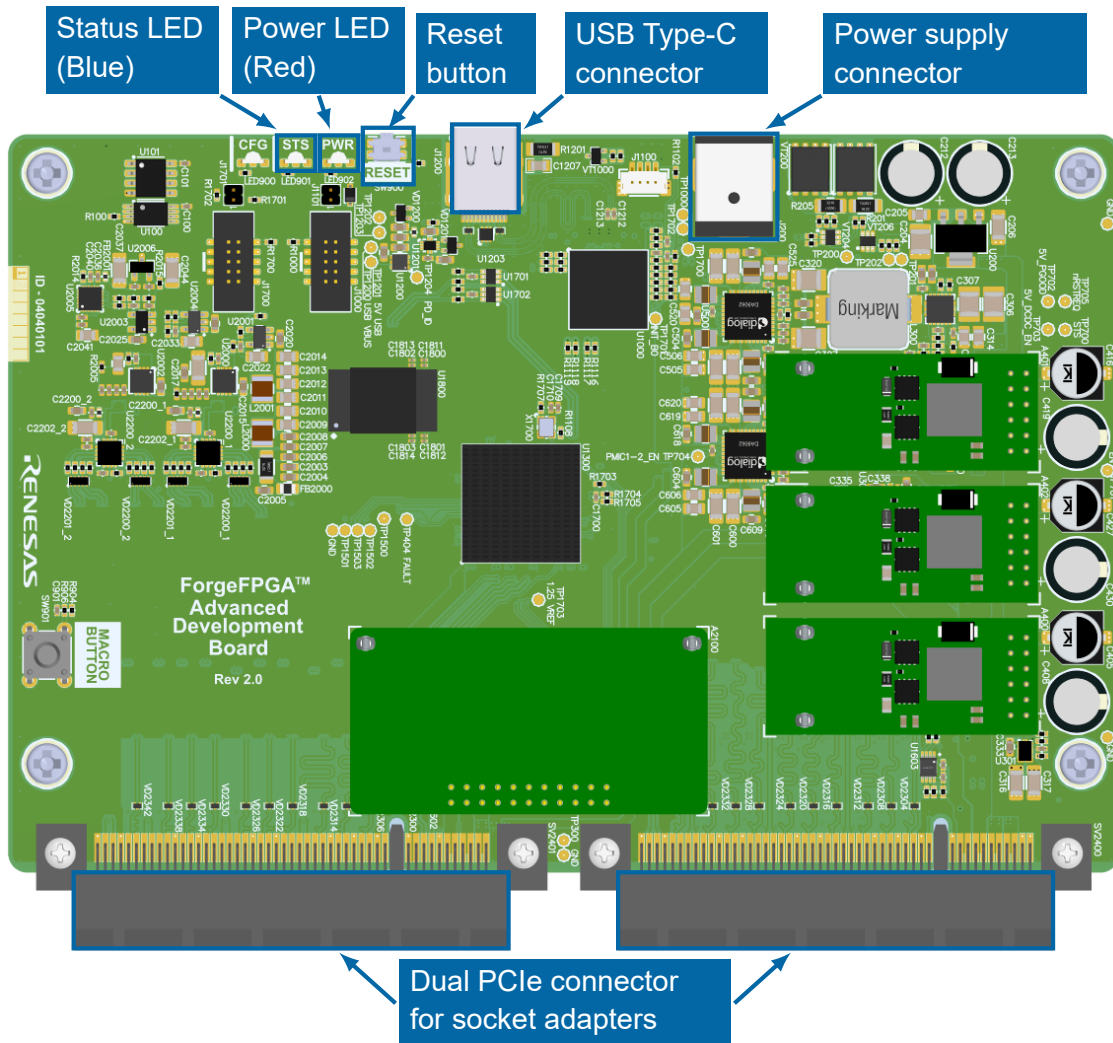

**ForgeFPGA Advanced Development Board Rev. 2.0**

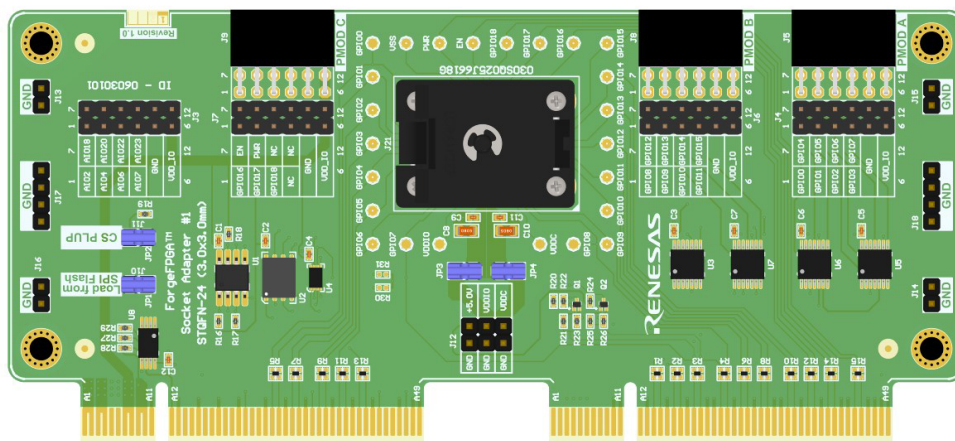

**ForgeFPGA socket adapter**

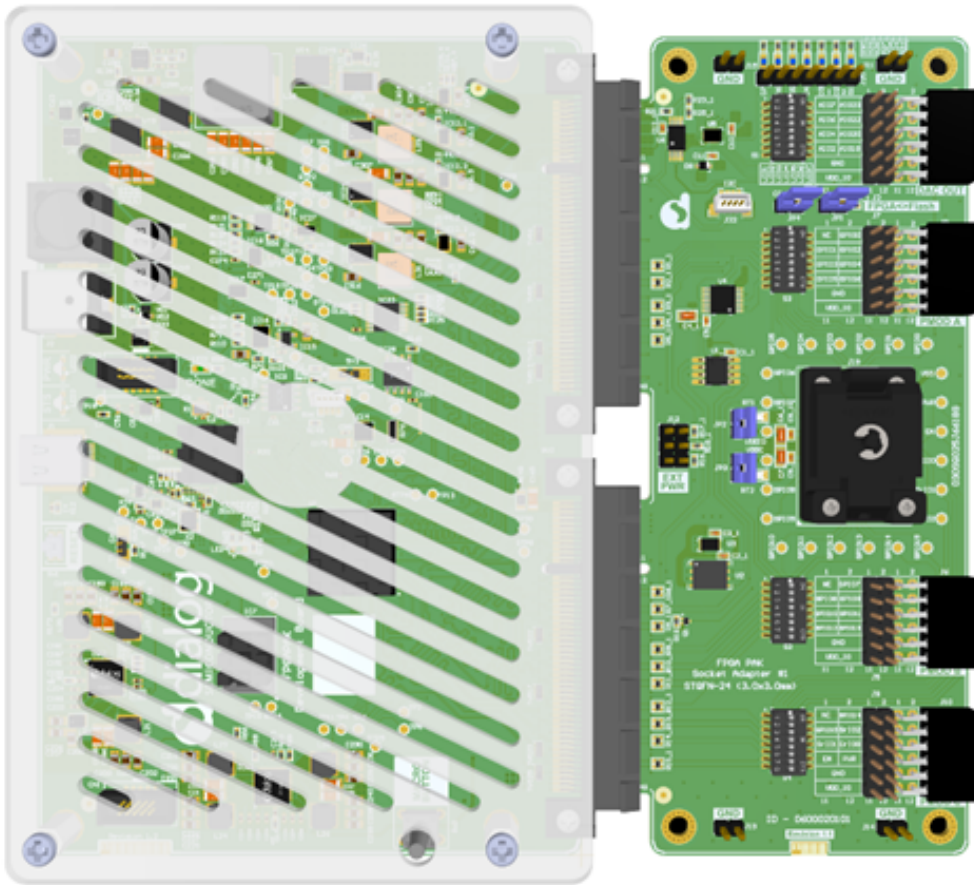

**Assembled equipment for working with a chip**

The *ForgeFPGA Advanced Development Board Debugging Controls* User Interface includes the following sections:

Debug Configuration	Program	Erase (flash)
Emulation	Test Mode* (flash)	Generator controls
Test Mode	Read (flash)	TP map
Read	Program (flash)	Info details

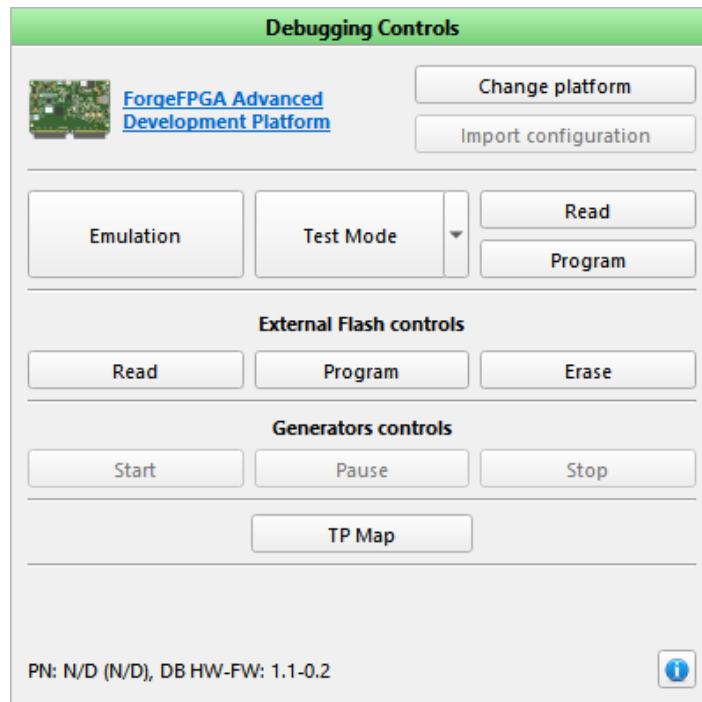

**ForgeFPGA Advanced Development Board controls**

Find a comparison of the controls available on different FPGA boards in the appendix, section [6.3 Debugging Controls feature availability](#).

### 3.2.2 ForgeFPGA™ Evaluation Board

- ▶ Programming and emulation for *ForgeFPGA* devices
- ▶ PMOD connectors
- ▶ UART connector for USB UART bridge mode
- ▶ USB interface for power and communication (USB-C connector)

**Note:** There are two variations of *ForgeFPGA Evaluation Board*: version 2.0 and 1.0. *ForgeFPGA Evaluation Board v.1.0* is a simplified version of the platform and does not support chip programming. Since the socket is absent, the SLG47910 IC is soldered directly on the board.

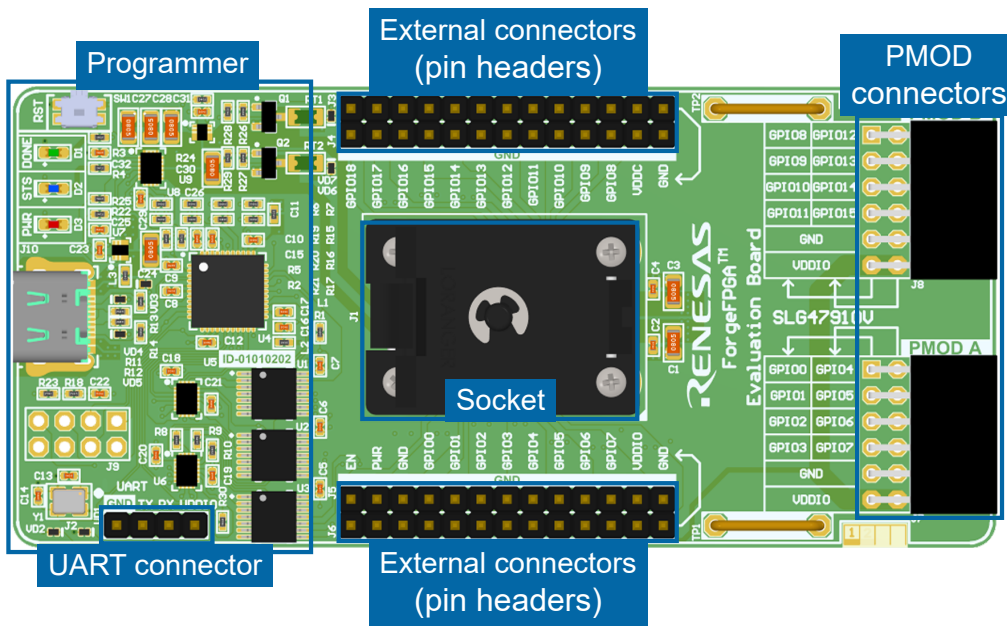

ForgeFPGA Evaluation Board 2.0

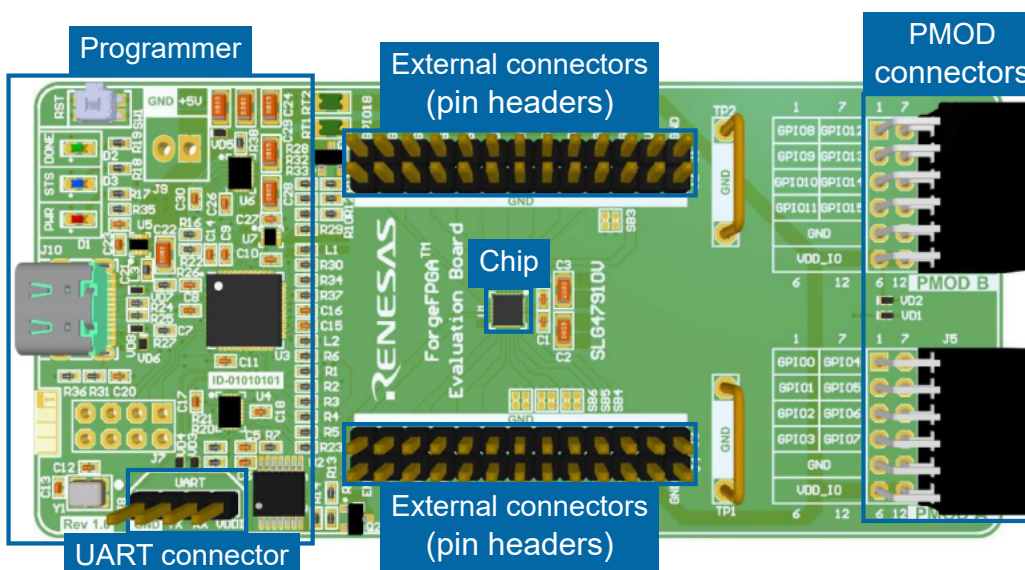

ForgeFPGA Evaluation Board 1.0

The *ForgeFPGA Evaluation Board Debugging Controls* User Interface includes the following sections:

Debug Configuration

Program

Emulation

Voltage level controls

Test Mode

Info details

Read

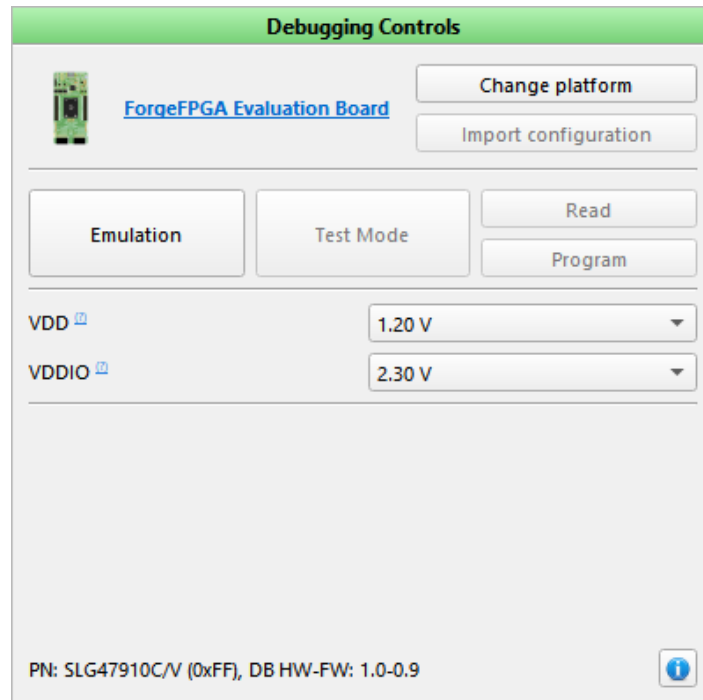

**ForgeFPGA Evaluation Board controls**

Find a comparison of the controls available on different FPGA boards in the appendix, section [6.3 Debugging Controls feature availability](#).



# 3.3 PowerPAK Devices

## 3.3.1 PowerPAK Development Platform

- Programming and emulation for *Power GreenPAK* devices (SLG51000, SLG51001, SLG51002, and SLG51003)
- Individually configurable Test Points (TPs):
  - Onboard LED state indication
  - Programmable software button (VDD, GND, Hi-Z)
  - Pull Up/Pull down jumpers
  - Floating hooks on each TP for oscilloscope connection
- Internal (onboard DC modules) and external power supply (TIP connectors) for IC's LDOs Vin
- Voltage measurement for chip's LDOs Vin/Vout channels
- USB interface for communication (USB-C connector)
- External 12V power supply
- In-System Debugging (ISD) functionality

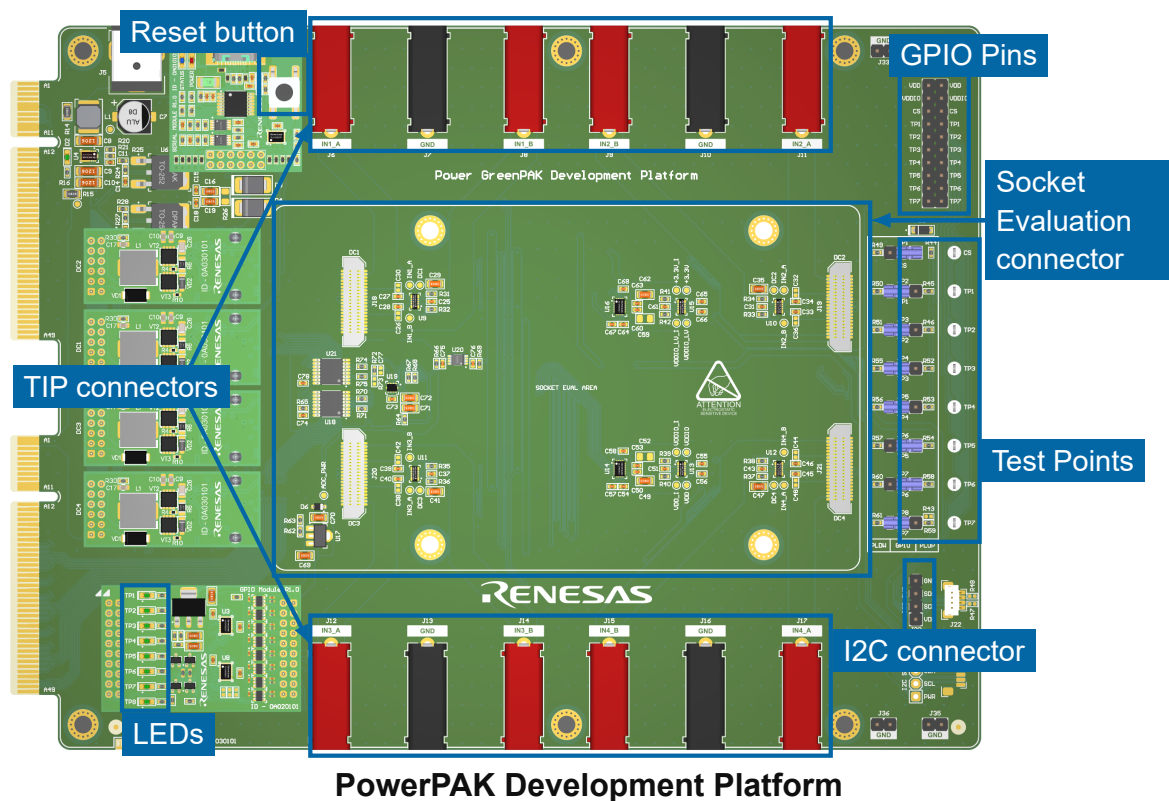

The *PowerPAK Development Platform Debugging Controls* User Interface includes the following sections:

Debug Configuration

Voltage level controls

Device selector

PowerPAK voltage controls

Emulation

LEDs ON and LEDs OFF

Sync

TP map

Test Mode

Info details

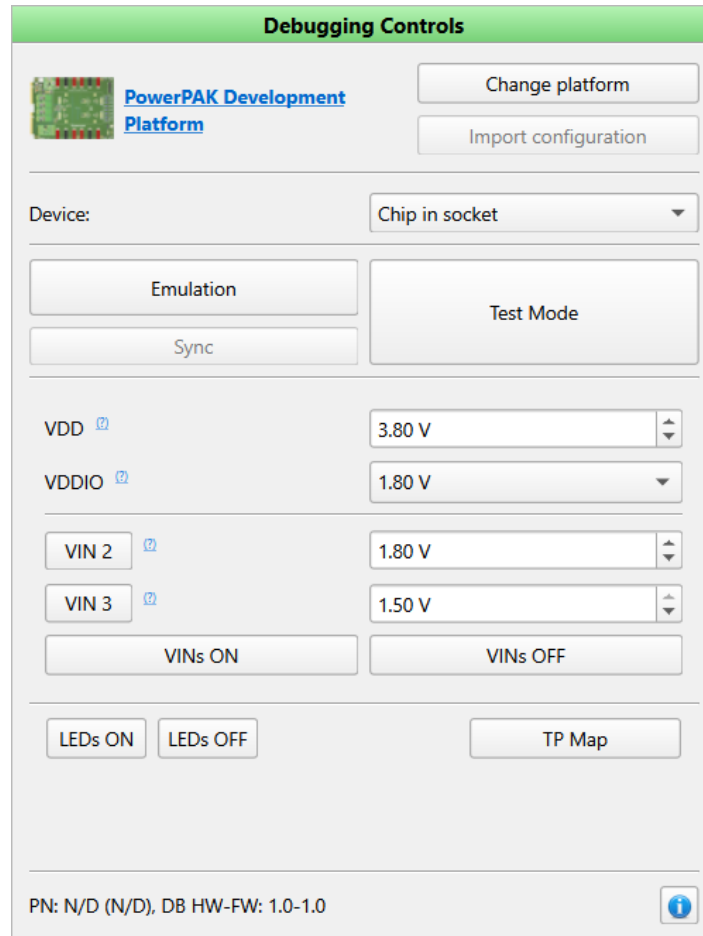

**PowerPAK Development Platform controls**

Find a comparison of the controls available on different PowerPAK boards in the appendix, section 6.3 Debugging Controls feature availability.

### 3.3.2 PowerPAK SLG51002C Demo board

- ▶ Programming and emulation for SLG51002
- ▶ Individually configurable Test Points (TPs):
  - Programmable software button (VDD, GND, Hi-Z)
  - Pull Up jumpers
  - Floating hooks on each TP for oscilloscope connection
- ▶ SMB connectors for measurement LDO parameters
- ▶ USB interface for communication (USB-C connector)
- ▶ External 12v power supply

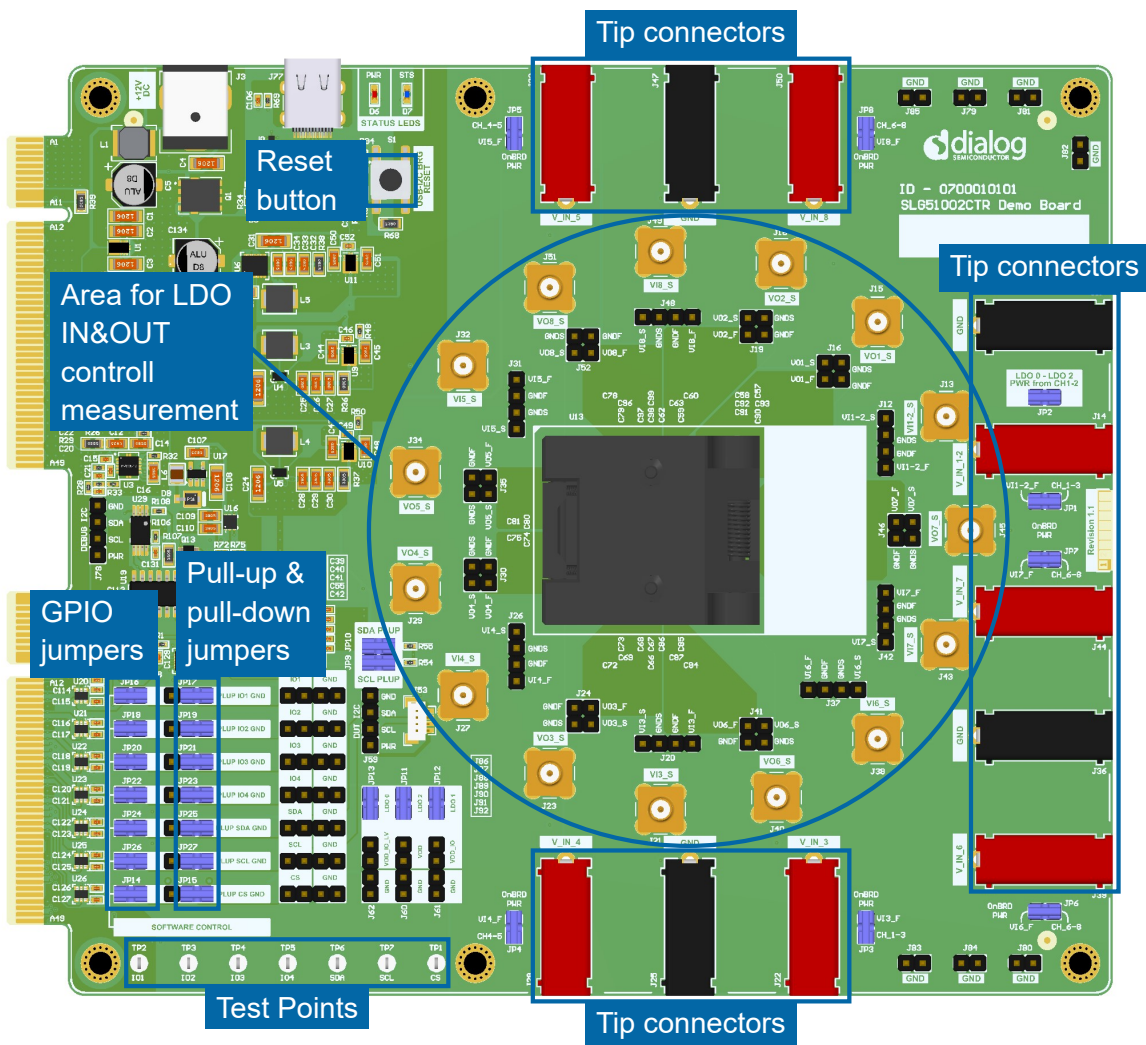

PowerPAK SLG51002C Demo board



The *PowerPAK SLG51002CTR Demo Board Debugging Controls* User Interface includes the following sections:

Debug Configuration

Test Mode

PowerPAK voltage controls

Emulation

GPIO SW Control

Info details

Sync

Voltage level controls

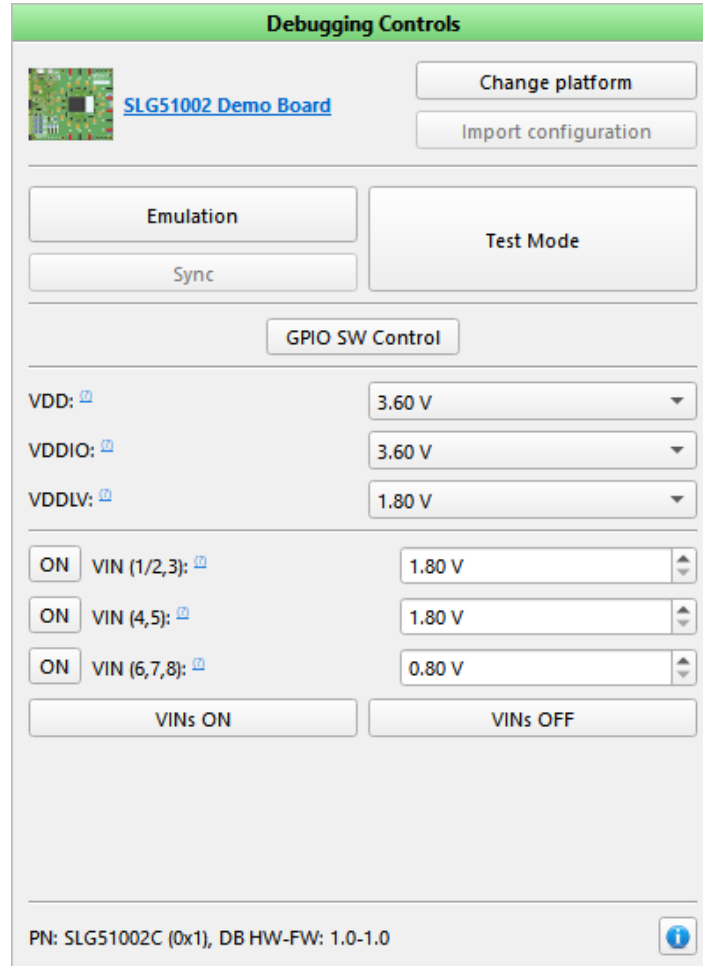

**PowerPAK 002 Demo Board controls**

Find a comparison of the controls available on different PowerPAK boards in the appendix, section 6.3 Debugging Controls feature availability.

### 3.3.3 Connecting external PowerPAK

#### Serial Debugger platform

You can use *GreenPAK Serial Debugger* for an external chip debugging of PowerPAK part numbers.

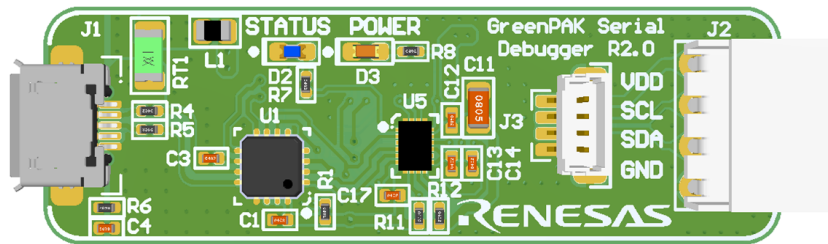

**GreenPAK Serial debugger**

To start working with an external chip on the *Serial Debugger* platform:

- ▶ Connect a chip with wires to the *Serial Debugger* pins (*CLK*, *SDA*, *GND*). If you use *SLG5100xCRT Socket Eval.*, use the DUT I2C connector.
- ▶ Ensure the Evaluation board's CS pin has been pulled-up to VDD or VDDIO. Connect the external power supply to VDD and VDDIO inputs.
- ▶ Start the *Go Configure Software Hub* and select the Part Number of the connected external chip
- ▶ Start the *Debug tool* and select the *Serial Debugger platform*
- ▶ Select *I2C Device address* or a corresponding address programmed to the chip
- ▶ Specify VDD configuration — VDD applied for I2C
- ▶ Connect the chip power sources externally

Once all steps are completed, the debugging controls become active.

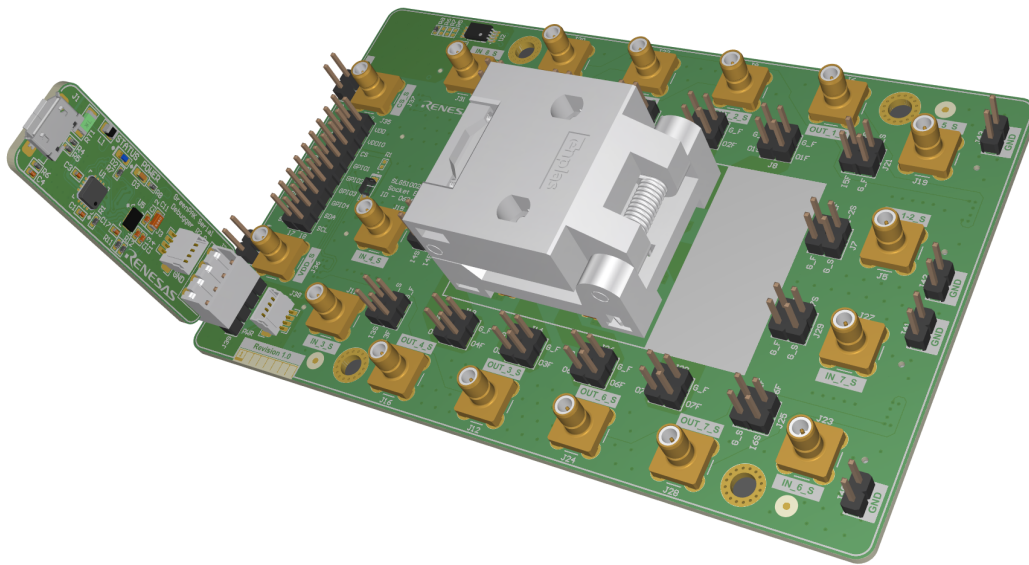

**GreenPAK Serial Debugger with PowerPAK socket**

*Debugging Controls* interface for the *GreenPAK Serial Debugger Platform* (with SLG5100x device) includes:

Debug Configuration

Sync

Info details

Device selector

Test Mode

Emulation

Voltage level controls

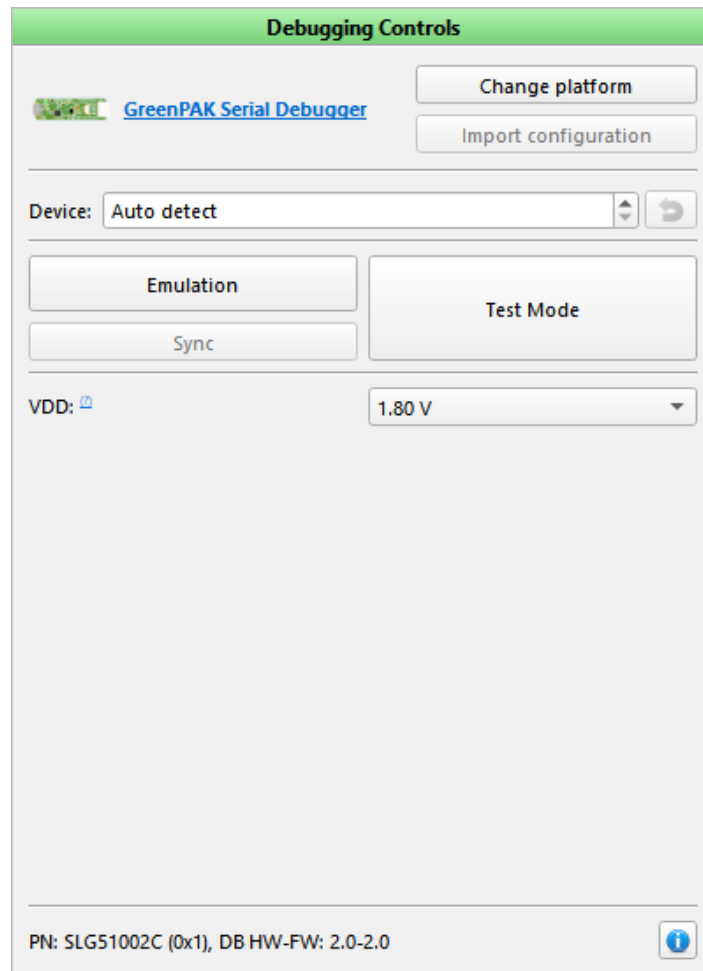

**PowerPAK Serial debugger controls**

Find a comparison of the controls available on different *PowerPAK* boards in the appendix, section [Debugging Controls feature availability](#).

# 4 How to

In addition to facilitating chip configuration, the *Go Configure Software Hub* offers a range of specific features designed to enhance your workflow efficiency. While these features may not be directly tied to your project, they can greatly assist you in streamlining various aspects of your work process.

This chapter presents the methods to keep your software version up to date and introduces various approaches for updating software. Furthermore, you will learn how to create and save block diagrams, delve into debug tool-related instructions, and explore the integration of external software within your project.

## 4.1 Software update

Software updates improve user experience by addressing issues and offering new features. Updates can provide access to new templates, resources, or content libraries that can enhance the creative process.

There are two ways of updating the *Go Configure Software Hub*:

- ▶ When updates are available, a notification appears. You can either download the latest version or postpone the update until the program restarts. After the download is complete, the *Go Configure Software Hub* will handle the automatic installation of the software. **Note:** it is important to restart the software after the installation process is done.
- ▶ You can also find the latest version of the *Go Configure Software Hub* on the [Software page](#) on the [Renesas website](#). To ensure the best user experience, keep your software up to date.

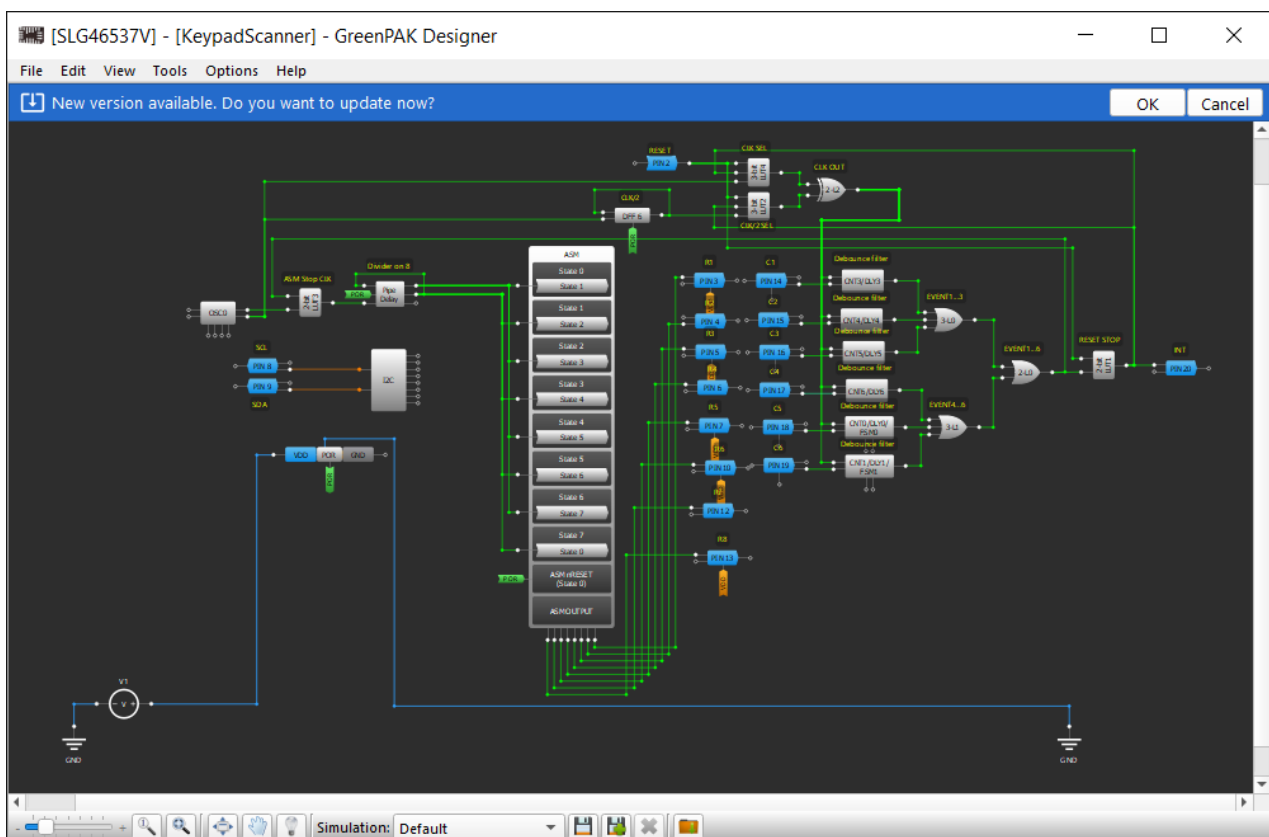

Software update notification

Adjust the *Updater* preferences in the *Designer Settings* window, *Updater* section (refer to [Section 2.1.7 Settings](#)).

Feel free to email suggested updates to the developer team to improve the software (click *Help* → *About Go Configure Software Hub*).

## 4.2 Printing

### 4.2.1 Print

You can use the *Print tool* to present and save a block diagram in a graphic format to use these images in datasheets or other project documentation showing the interconnections between blocks and their configurations. Find the *Print tool* on the toolbar.

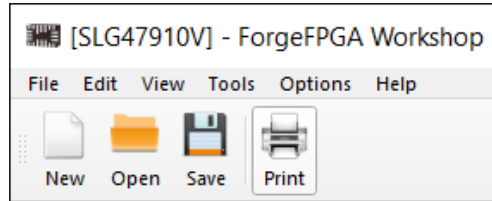

**Print tool on the toolbar**

Also, you can open the *Print tool* by clicking *File* → *Print* in the main menu.

To open the *Print Preview* window, click the *Print* button in the top toolbar. This window shows a ready-to-print diagram and tables with block configurations. At this point, you can't change the position of elements or lines on the diagram. To reposition components or wires, you should return to the working area, introduce the changes, and launch the *Print Tool* again.

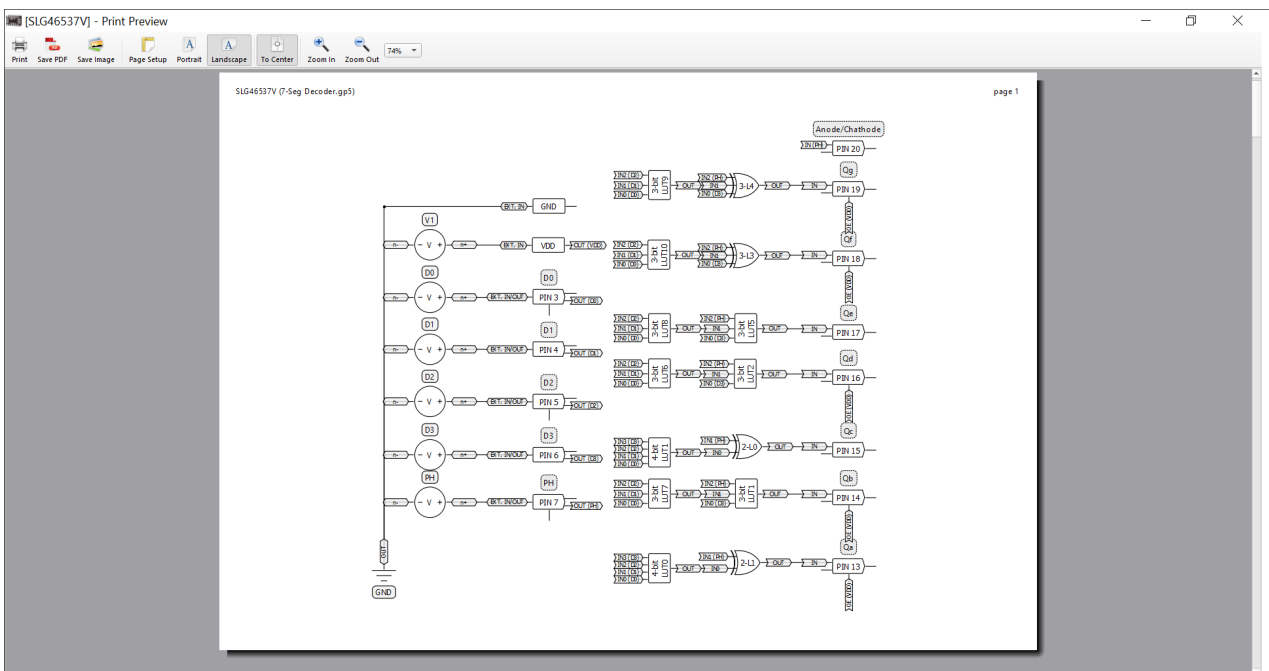

**Print Preview window**

Additionally, the *Print Preview* window contains a table with a list of all blocks and their configurations.

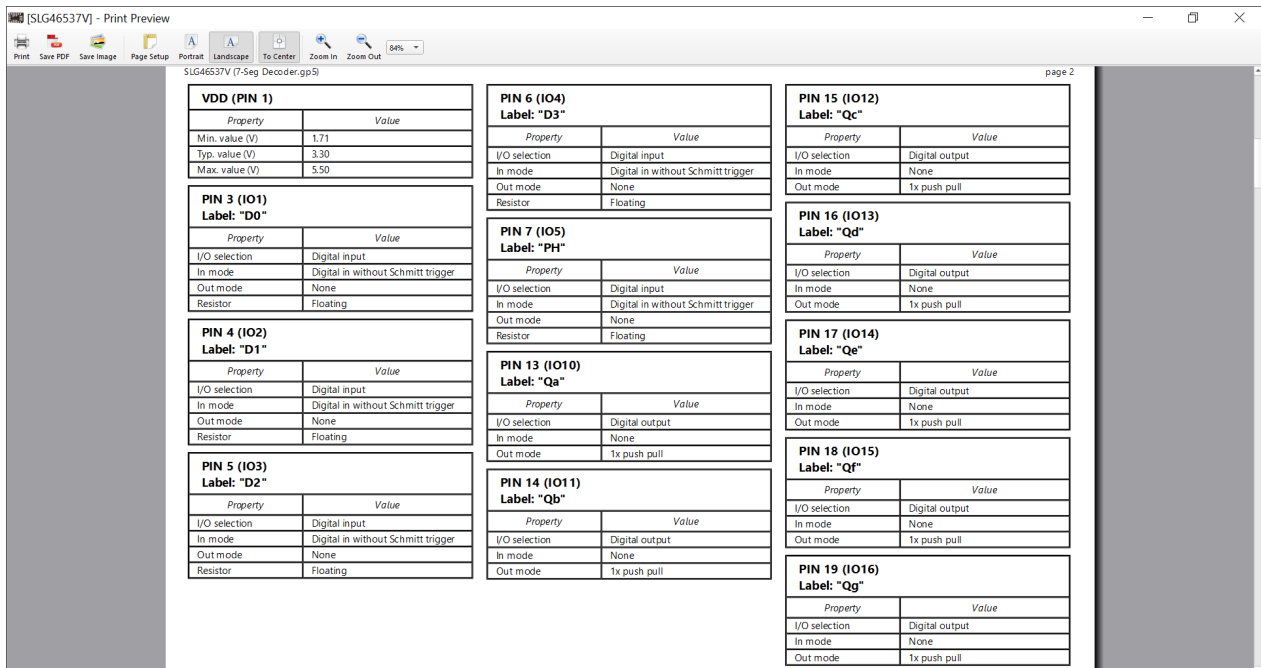
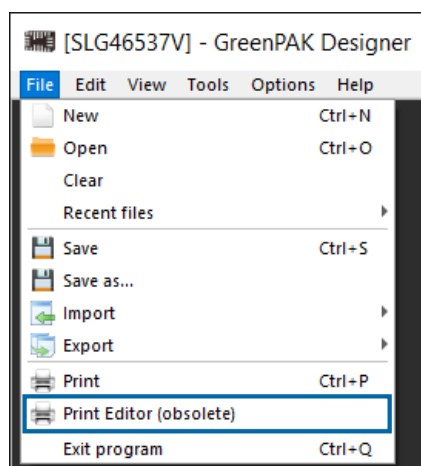

Table with block properties and values in Print Preview window

## 4.2.2 Print Editor (obsolete)

In the older versions of the software updates, the *Print editor (obsolete)* is available. You can find this tool by clicking *File → Print Editor (obsolete)*.



Print Editor (obsolete)

The *Print Editor* allows pre-print configuration such as rotating, flipping, and hiding some components or adding text labels.

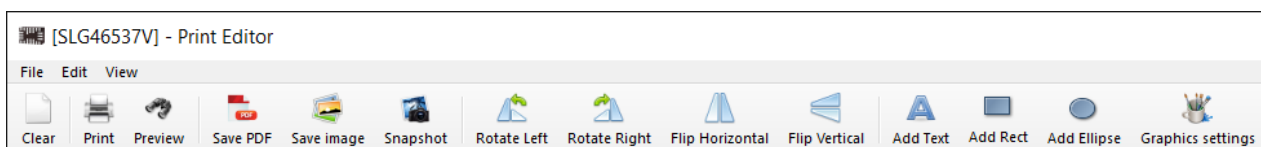

Print Editor toolbar



An editable working area of the *Print Editor (obsolete)* contains all components used in the design. It enables customizing positions, views of components, and wires.

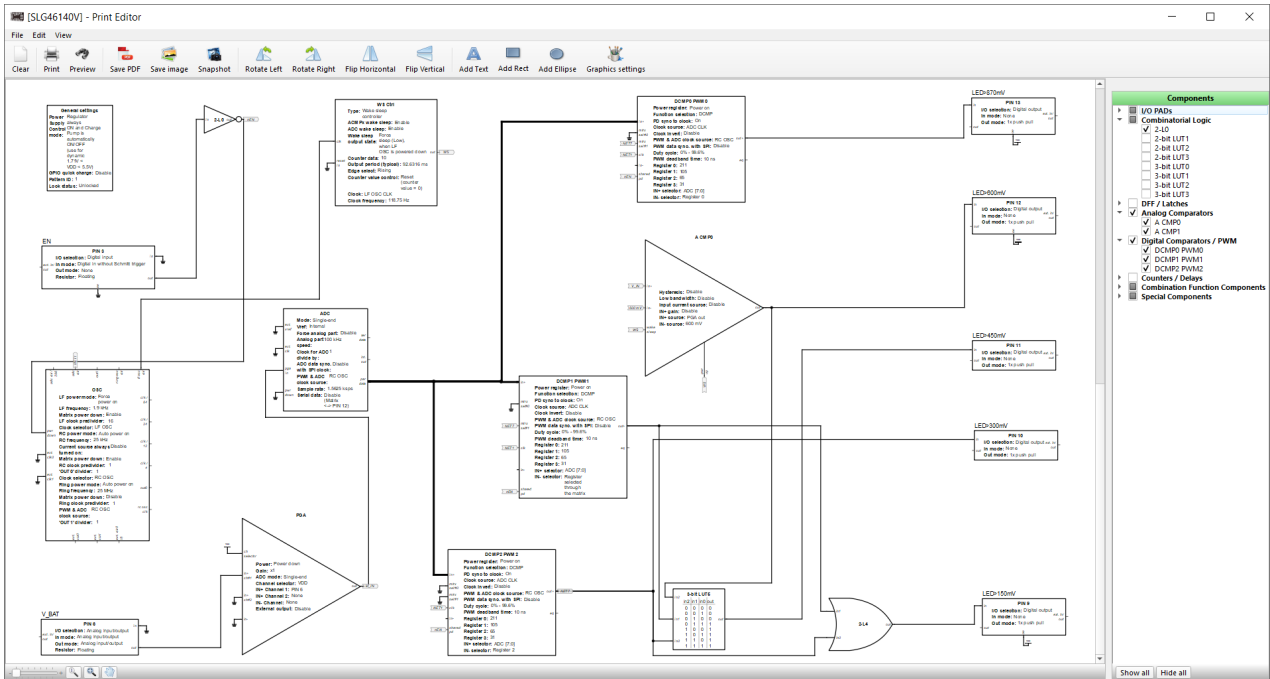

Print Editor (obsolete) interface

## 4.3 Icarus Verilog and GTKWave quick start

The *Icarus Verilog* and *GTKWave* software serve as simulation and simulation results visualizing tools for validating Verilog design code using a testbench. Within the testbench, you can instantiate the *Unit Under Test (UUT)* or *Device Under Test (DUT)* and systematically apply input combinations. You can observe and analyze the resulting outputs using the *GTKWave* software.

### 4.3.1 Installation

Install the latest version of Icarus Verilog (iVerilog) from [here](#). The download package includes both Icarus Verilog for simulation and *GTKWave* for visualizing simulation results. It is important to install both of these components to ensure proper functionality. Add iVerilog and *GTKWave* to the system paths during the installation process. If you overlook this step, you can add these paths later by navigating *FPGA Editor* → *Options* → *Settings* → *Tools*.

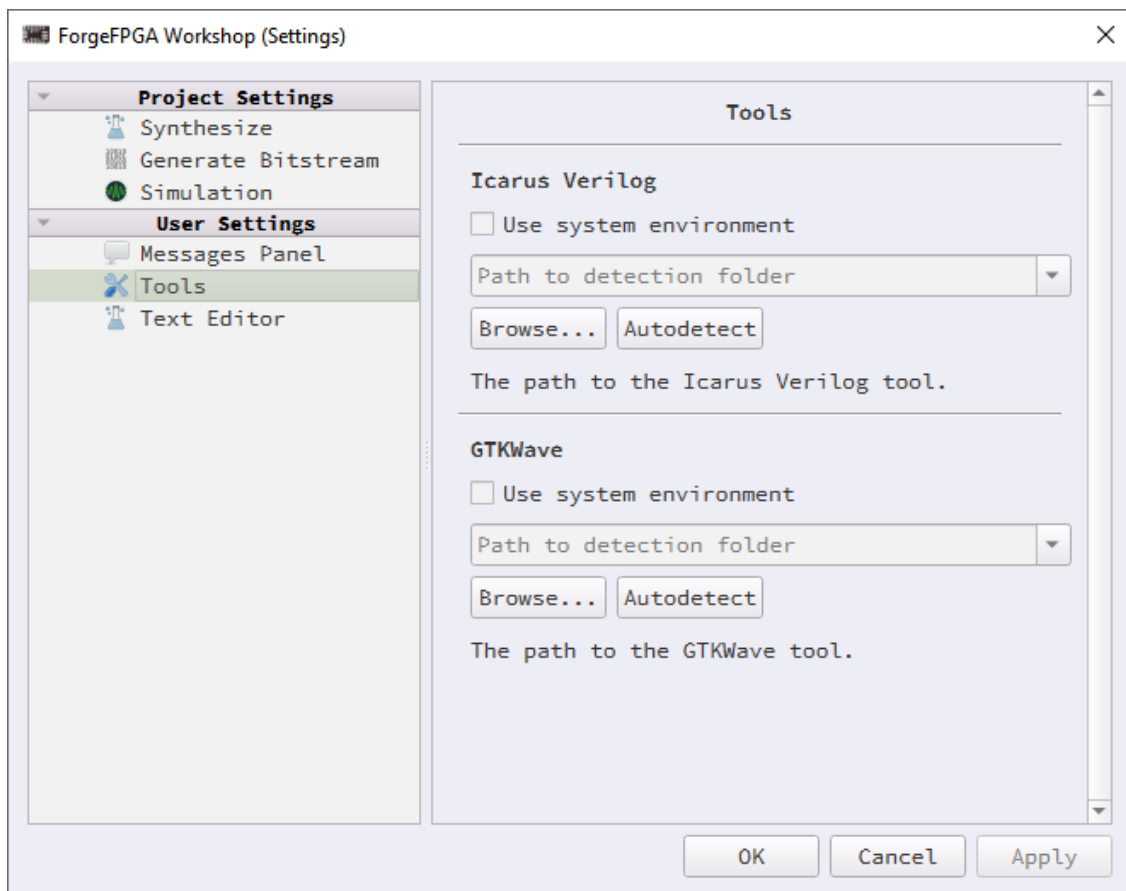

**FPGA Editor Settings**

### 4.3.2 Quick start

Below are some useful tips for using the Icarus Verilog and *GTKWave* software within your workflow with ForgeFPGA Workshop.

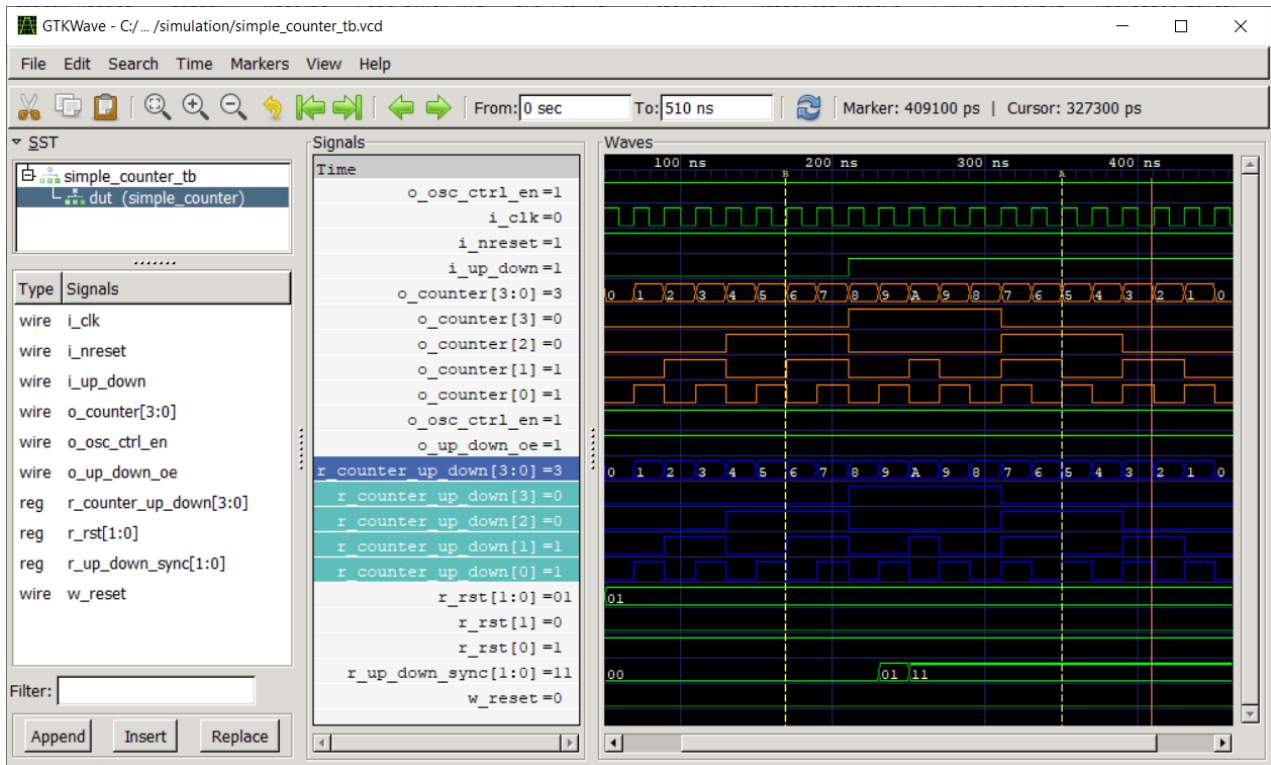

**Simple Counter in GTKWave software**

- Access GTKWave by either clicking *Simulate Testbench* in the ForgeFPGA Workshop or entering `gtkwave` in the terminal. If you opt to launch the software externally, please select the `.vcd` files. These files serve as dump files generated by Icarus Verilog launched by ForgeFPGA Workshop when running a testbench (simulation).
- Generate a `.vcd` file. When creating a custom testbench, the ForgeFPGA Workshop automatically inserts two lines for `$dumpfile` (creates dump files) and `$dumpvars` (assigns various values to signals in the design) in the `initial` block of the template code. These lines are tailored to the module's name.

```

1 // Custom testbench
2
3 `timescale 1ns / 1ps
4
5 module ALU16_tb;
6
7     initial begin
8
9         $dumpfile ("ALU16_tb.vcd");
10        $dumpvars (0, ALU16_tb);
11
12    end
13
14 endmodule

```

The `initial` block is executed only once. Above the `initial` block you can find the declaration of input and output signals, along with the module instantiation.

- ▶ Start the simulation by clicking the *Simulate Testbench* button in the ForgeFPGA Workshop. This action triggers GTKWave to automatically open the corresponding .vcd file generated by Icarus Verilog. Upon the *Wave* window's launch, no waveforms are initially displayed, giving you the option to select the specific signals whose waveforms you wish to view.
- ▶ Select the desired signal by navigating to the *SST* window, showcasing your hardware hierarchy. You can reveal the signals associated with that specific instance in the bottom section. Either drag and drop the preferred signal or double-click on it to display it in the *Signals* window. Alternatively, you can select all signals (Ctrl + A) and insert them. Also, to observe the signals' respective values, click the *Reload* button on the toolbar.
- ▶ Customize signal properties in the context menu of a signal and selecting *Data Format* or *Color Format*. By default, signal values are in hexadecimal format, and all waves are colored green (if the simulation is running correctly). Additionally, you can *Insert Blank* signal to create sections between groups of signals.
- ▶ Save settings by navigating to *File* → *Write Save File* once you achieved the desired visual configuration. Saving your progress ensures that when you simulate the same testbench next time, most of your previous adjustments will be automatically restored.

For additional details and features, please consult the complete GTKWave and Icarus Verilog user guides.

# 5 Troubleshooting

Challenges are an essential part of any creative process. Providing solutions is of great importance for us to help you overcome obstacles, you may encounter while using the software.

In this chapter, we'll help you tackle common problems you might face while using the software. We'll cover troubleshooting for issues like technical glitches, error messages, or unexpected behavior. By following these steps, you'll be able to solve problems easily and make the most out of your software experience.

## 5.1 Failed Socket Test

Here is the list of steps to solve the most common causes of the [Socket Test](#) procedure failure:

- ▶ Ensure the contacts connecting a socket and chip pins are clean and undamaged
- ▶ Disconnect any external circuits or signal sources (generator, voltage supply, etc) connected to a board or a socket itself  
**Note:** External devices connected to expansions connectors do not affect the *Socket Test* procedure.
- ▶ Reconnect a board to a USB port
- ▶ Use an empty chip, if possible  
**Note:** Certain combinations of chip memory protection bits or specific I2C configurations on already programmed silicons may cause *Socket Test* to fail.

### SLG47011V Evaluation Board

- ▶ **Socket Test failed on Test Point 10** → Check the PIN15/VREF jumper position. This jumper should connect PIN15 to Test Point 10. To pass *Socket Test*, please try the following configuration:

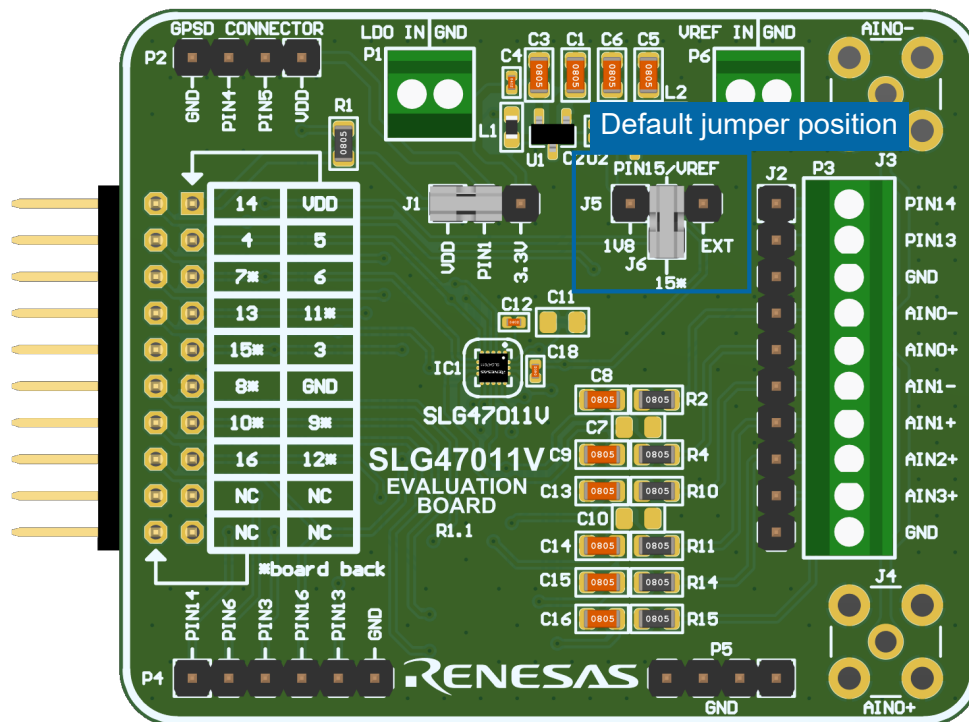

SLG47011V Evaluation Board, default PIN15/VREF jumper position

# 6 Appendices

## 6.1 Main menu commands

### File

<i>New</i>	start a new or open existing project from Go Configure Software Hub
<i>Open</i>	open an existing project in software tools
<i>Save</i>	save current project
<i>Save as</i>	save the current project in a specified location
<i>Import NVM bits</i>	load configuration bits from a text file
<i>Export NVM bits</i>	save configuration bits to a text file
<i>Print</i>	a simple print feature without detailed block information
<i>Print Editor (Obsolete)</i>	start the Print Editor
<i>Exit program</i>	close software tools

### Edit

<i>Rotate Left</i>	rotate a selected block counterclockwise
<i>Rotate Right</i>	rotate a selected block clockwise
<i>Flip Horizontal</i>	a horizontal reflection of a selected block
<i>Flip Vertical</i>	a vertical reflection of a selected block
<i>Align Horizontal</i>	horizontal alignment of selected blocks
<i>Align Vertical</i>	vertical alignment of selected blocks
<i>Set Label</i>	creating a text label for selected blocks
<i>Erase Label</i>	erasing text labels near selected blocks
<i>Set Wire</i>	enable wire creating mode
<i>Erase Wire</i>	enable wire erase mode

### View

<i>Zoom in</i>	increase the work area scale
<i>Zoom out</i>	decrease the work area scale
<i>Fit work area</i>	tune scale to show all blocks visible in the project
<i>Zoom 1:1</i>	set default scale
<i>Full-screen mode</i>	switch to full-screen mode
<i>Pan mode</i>	enable/disable the work area move in pan mode
<i>Show hints</i>	enable/disable hints for blocks on the work area
<i>Properties</i>	show/hide Properties panel
<i>Schematic Library</i>	list of external components for Software Simulation
<i>Components</i>	show/hide software tools blocks list
<i>NVM Viewer</i>	show/hide NVM bits viewer
<i>Rule Checker Output</i>	scan the project for design errors

### Tools

<i>Debug</i>	convenient project testing
<i>Rule Checker</i>	check current design for correct settings
<i>Comparison</i>	compare bits of two projects
<i>ASM Editor</i>	configure the State Machine using state diagram and set the output configuration for SM Output block
<i>I2C Tools</i>	enhanced I2C Tools with I2C snapshot Reconfigurator

### Options

<i>Settings</i>	set the default projects folder, autosave interval, toolbars position, recovery, shortcuts, and update options
-----------------	--

### Help

<i>Help</i>	show help window
-------------	------------------



<i>User Guides</i>	open User guides on the web
<i>Legend box</i>	show the color legend box
<i>Renesas web site</i>	open the Renesas official website
<i>Software and documentation</i>	open Software and Documentation web page
<i>Renesas web store</i>	open Renesas chip store
<i>Design support</i>	web page with training courses and videos
<i>Contact Us</i>	web form with request
<i>Social</i>	Renesas in social networks
<i>Application Notes</i>	open examples web page
<i>Datasheet</i>	open documentation web page
<i>Updater</i>	open software update tool
<i>About Go Configure Software Hub</i>	show information about software tools version modification

## 6.2 Keyboard and mouse controls

<b>Basic tools</b>		
<b>Action</b>	<b>Windows/Linux controls</b>	<b>macOS controls</b>
NVM Viewer	F2	F2
Component properties	F3	F3
Apply changes	Ctrl + A	Command + A
Revert changes	Ctrl + U	Command + U
Reset settings to default	Ctrl + Shift + R	Command + Shift + R
Reset connections to default	Ctrl + Shift + C	Command + Shift + C
Component List	F4	F4
Filter on the Component List	Ctrl + F	Command + F
Rule Checker	F5	F5
Debug tool	F9	F9

<b>Components and connections</b>		
<b>Action</b>	<b>Windows/Linux controls</b>	<b>macOS controls</b>
Move selected block(s) by 1 pixel*	Alt + left/right	Alt + left/right
Move selected block(s) by 10 pixels*	Ctrl + left/right	Command + left/right
Rotate selected component(s) left	Ctrl + L	Command + L
Rotate selected component(s) right	Ctrl + R	Command + R
Flip selected component(s) horizontally	Ctrl + Shift + H	Command + Shift + H
Flip selected component(s) vertically	Ctrl + Shift + V	Command + Shift + V
Hide selected component(s)	H	H
Remove selected external component(s)	Del	Backspace
Set wire	Ctrl + W	Command + W
Erase wire	Ctrl + E	Command + E
Discard adding a wire*	RMB	RMB
Force <i>Set wire</i> while <i>Erase wire</i> is enabled*	Hold Shift	Hold Shift
Force <i>Erase wire</i> while <i>Set wire</i> is enabled*	Hold Alt	Hold Alt
Add multiple wires from the same source*	Hold Ctrl	Hold Command
Add multiple wires from the same source while <i>Erase Wire</i> is enabled*	Hold Ctrl + Shift	Hold Command + Shift
Force remove network while <i>Set wire</i> is enabled*	Hold Ctrl + Alt	Hold Command + Alt
Copy external components	Ctrl + C	Command + C

Paste external components	Ctrl + V	Command + V
---------------------------	----------	-------------

<b>Simulation results</b>		
<b>Action</b>	<b>Windows/Linux controls</b>	<b>macOS controls</b>
Move the plot*	Hold MMB	Hold MMB
Add one marker on the plot*	Ctrl + LMB/RMB	Command + LMB/RMB
Add two markers on the plot*	Ctrl + LMB + RMB	Command + LMB + RMB
Clear all markers*	Esc	Esc
Zoom in/out x-axis*	Ctrl + mouse wheel	Command + mouse wheel
Zoom in/out y-axis*	Shift + mouse wheel	Shift + mouse wheel
Help*	F1	F1

<b>Import model/subcircuit</b>		
<b>Action</b>	<b>Windows/Linux controls</b>	<b>macOS controls</b>
Open search field*	Ctrl + F	Command + F
Close search field*	Esc	Esc

<b>Debug</b>		
<b>Action</b>	<b>Windows/Linux controls</b>	<b>macOS controls</b>
Emulation	Shift + E	Shift + E
Program	Shift + P	Shift + P
Read	Shift + R	Shift + R
Test Mode	Shift + T	Shift + T
NVM Data	Shift + N	Shift + N
Info	Shift + I	Shift + I
Log	Shift + L	Shift + L

<b>I2C reconfigurator</b>		
<b>Action</b>	<b>Windows/Linux controls</b>	<b>macOS controls</b>
Create snapshot*	Shift + A	Shift + A
Add delay*	Shift + D	Shift + D
Move up*	Shift + up	Shift + up
Move down*	Shift + down	Shift + E
Send one snapshot*	F7	F7
Send all snapshots*	F6	F6
Stop sending snapshots*	Shift + F7	Shift + F7

<b>ASM editor</b>		
<b>Action</b>	<b>Windows/Linux controls</b>	<b>macOS controls</b>
Set link	Ctrl + W	Command + W
Erase link	Ctrl + E	Command + E
Clear	Ctrl + N	Command + N
Undo	Ctrl + Z	Command + Z
Redo	Ctrl + Y	Command + Y

Help	F1	F1
------	----	----

<b>General</b>		
<b>Action</b>	<b>Windows/Linux controls</b>	<b>macOS controls</b>
New project	Ctrl + N	Command + N
Open project	Ctrl + O	Command + O
Save project	Ctrl + S	Command + S
Undo	Ctrl + Z	Command + Z
Redo	Ctrl + Y	Command + Y
Zoom in work area	+	+
Zoom out work area	-	-
Fullscreen mode	F11	F11
Print	Ctrl + P	Command + P
Help	F1	F1
Exit program	Ctrl + Q	Command + Q

<b>Software tool launcher</b>		
<b>Action</b>	<b>Windows/Linux controls</b>	<b>macOS controls</b>
Welcome tab*	Ctrl + 1	Command + 1
Recent files tab*	Ctrl + 2	Command + 2
Develop tab*	Ctrl + 3	Command + 3
Demo tab*	Ctrl + 4	Command + 4
Recovery files tab*	Ctrl + 5	Command + 5
Datasheets*	Ctrl + 6	Command + 6
User guide*	Ctrl + 7	Command + 7

**Note:** Non-configurable controls are marked with an asterisk (\*).

## 6.3 Debugging Controls feature availability

### GreenPAK platforms

Feature	Advanced board	DIP board	Lite board	Serial Debugger
Debug Configuration	✓	✓	✓	✓
Device selector	✓	✓	✓	✓
External device mode			✓	
Chip procedures	✓	✓	✓	✓
Project data window	✓	✓	✓	✓
Generator controls	✓	✓		
Expansion connector	✓	✓	✓	
TP map	✓	✓	✓	
Power source selector	✓	✓	✓	✓
Voltage level controls			✓	✓
LEDs ON and LEDs OFF	✓	✓	✓	
Info details	✓	✓	✓	✓

### FPGA platforms

Feature	ForgeFPGA Advanced Development Board	ForgeFPGA Evaluation Board
Debug Configuration	✓	✓
Chip procedures	✓	✓
Flash procedures	✓	
Generator controls	✓	
TP map	✓	
Voltage level controls		✓
Info details	✓	✓

### PowerPAK platforms

Feature	PowerPAK Development Platform	SLG51002CTR Demo Board	Serial Debugger(with SLG5100x)
Debug Configuration	✓	✓	✓
Device selector	✓		✓
Chip procedures	✓	✓	✓
GPIO SW Control		✓	
TP map	✓		
Voltage level controls	✓	✓	✓
PowerPAK voltage controls	✓	✓	
Info details	✓	✓	✓

## 6.4 Abbreviations

<b>Abbreviation</b>	<b>Description</b>
<i>ASM</i>	Asynchronous State Machine
<i>CLK</i>	Clock
<i>CS</i>	Circuit Switched
<i>DC</i>	Direct Current
<i>DIP</i>	Dual In-Line Package
<i>EEPROM</i>	Electrically Erasable Programmable Read-only Memory
<i>EPG</i>	Extended Pattern Generator
<i>FPGA</i>	Field-Programmable Gate Array
<i>GND</i>	Ground
<i>GPI</i>	General-Purpose Input
<i>GPIO</i>	General-Purpose Input/Output
<i>I/O</i>	Input/Output
<i>I2C</i>	Inter-Integrated Circuit
<i>IC</i>	Integrated Circuit
<i>IDE</i>	Integrated Development Environment
<i>IEC</i>	International Electrotechnical Commission
<i>LDO</i>	Low-Dropout Regulator
<i>LED</i>	Light Emitting Diode
<i>LUT</i>	Look-Up Table
<i>NC</i>	Not Connected
<i>NVM</i>	Non-Volatile Memory
<i>OE</i>	Output Enable
<i>OTP</i>	One-Time Programmable
<i>POR</i>	Power-On Reset
<i>PWM</i>	Pulse Width Modulation
<i>SCL</i>	Serial Clock
<i>SDA</i>	Serial Data
<i>SPI</i>	Serial Peripheral Interface
<i>SPICE</i>	Simulation Program with Integrated Circuit Emphasis
<i>TP</i>	Test Point
<i>UART</i>	Universal Asynchronous Receiver/Transmitter

## 6.5 Changelog

Version	Date	Changes
2.5.1	2024-07-04	<ul style="list-style-type: none"><li>• Added information about the new FPGA project creation approach in <a href="#">Working with project files</a> section</li><li>• Updated the <a href="#">Project directory structure</a> section with information about quick source file localization (FPGA Editor)</li><li>• Added <a href="#">note</a> about the requirement to save the modified modules before performing procedures (FPGA Editor)</li><li>• Fixed typos</li></ul>
2.5.0	2024-06-20	<ul style="list-style-type: none"><li>• Added information about the Speed control tool in the <a href="#">I2C Tools</a> section</li><li>• Updated the <a href="#">I2C Virtual Outputs</a> description with new macrocells support</li><li>• Extended the resource meter description in the <a href="#">Synchronous Logic Generator</a> section</li><li>• Added the description of new <a href="#">FPGA project structure</a></li><li>• Updated the <a href="#">Messages</a> panel description with new way of logs displaying (FPGA Editor)</li><li>• Added information about new status indication of the <a href="#">Synthesis/Generate bitstream procedures</a> (FPGA Editor)</li><li>• Updated the CPU and supported OS information in the <a href="#">System requirements</a> section</li></ul>
2.4.0	2024-04-26	<ul style="list-style-type: none"><li>• Added the new <a href="#">Acceleration Profile Configurator</a> section</li><li>• Added the new <a href="#">Reg File Configurator</a> section</li><li>• Added the new <a href="#">DAC Tool</a> section</li><li>• Added the new <a href="#">Power Monitor</a> section</li><li>• Added the new <a href="#">PLL Calculator</a> section (FPGA Editor)</li><li>• Updated the <a href="#">Memory Table Editor</a> section with information about Signal generator type</li><li>• Extended the <a href="#">Synchronous Logic Generator</a> content with new resource meter description</li><li>• Extended the <a href="#">Logic Analyzer</a> section with the description of export feature in <a href="#">Protocol Analyzer</a></li><li>• Updated the <a href="#">I/O Planner</a> content with the import/export formats information (FPGA Editor)</li><li>• Extended the <a href="#">I/O Planner</a> content with warning icons for invalid port names description (FPGA Editor)</li><li>• Extended the <a href="#">Macrocell Editor</a> content with Properties panel description (FPGA Editor)</li><li>• Added information about project checksum in <a href="#">Working with project files</a> section</li><li>• Substituted the <a href="#">Devices</a> section content with a feature list for each platform</li><li>• Updated the <a href="#">supported OS</a> list</li><li>• General content improvements</li></ul>

2.3.0	2024-02-12	<ul style="list-style-type: none"> <li>● Added the new <a href="#">Synthesis Report</a> section (FPGA Editor)</li> <li>● Added the new <a href="#">Design Templates</a> section (FPGA Editor)</li> <li>● Added the new <a href="#">Settings</a> section (FPGA Editor)</li> <li>● Added the <a href="#">Icarus Verilog and GTKWave quick start</a> guide in the How to section</li> <li>● Extended the <a href="#">Additional controls</a> section with a new option for the Split tool (FPGA Editor)</li> <li>● Extended the <a href="#">Simulating a testbench</a> section with information about ensuring persistence for simulation results (FPGA Editor)</li> <li>● Extended the Project settings window section with the <a href="#">Security tab</a> description</li> <li>● Improved and extended the <a href="#">ForgeFPGA devices</a> section</li> <li>● Improved the <a href="#">Logic Analyzer</a> section</li> <li>● Improved the <a href="#">I2C I/O Tool</a> section</li> <li>● Improved the <a href="#">I2C Tools</a> section</li> <li>● Updated the <a href="#">I/O Planner</a> section (FPGA Editor)</li> <li>● Fixed typos</li> </ul>
2.2.0	2023-12-22	<ul style="list-style-type: none"> <li>● Added a new <a href="#">Memory Table Editor</a> section</li> </ul>
2.1.0	2023-12-08	<ul style="list-style-type: none"> <li>● Added a new <a href="#">FPGA Editor</a> section</li> <li>● Added a new Troubleshooting section with the <a href="#">Failed Socket Test</a> solutions</li> <li>● Added a new section with the <a href="#">Voltage Monitor</a> tool</li> <li>● Extended the I2C Tools section with the new <a href="#">Memory Table</a> tool</li> <li>● Extended the I2C Tools section with the new <a href="#">Data Buffers</a> tool</li> <li>● Extended Debugging Controls for the PowerPAK Dev. Platform with the <a href="#">LEDs ON and LEDs OFF</a> feature description</li> <li>● Extended Debugging Controls for the PowerPAK Dev. Platform with the <a href="#">Device selector</a> (external chip support) feature description</li> <li>● Updated the <a href="#">Board Selector</a> in the Debugging Controls with the new information about the Socket Test</li> <li>● Updated the notification of the processing data time for Transient Simulation Analysis</li> <li>● Updated the <a href="#">System Requirements</a> section</li> <li>● Improved the Demo Board and Demo mode section</li> <li>● Improved the Hardware source image list</li> <li>● Fixed typos</li> </ul>
2.0.1	2023-10-25	<ul style="list-style-type: none"> <li>● Fixed typos</li> <li>● Added Changelog</li> </ul>
2.0.0	2023-10-13	<ul style="list-style-type: none"> <li>● New revised structure</li> <li>● Significantly improved navigation</li> <li>● Carefully selected materials</li> <li>● Improved instructions</li> <li>● Improved graphic material</li> </ul>



## IMPORTANT NOTICE AND DISCLAIMER

RENESAS ELECTRONICS CORPORATION AND ITS SUBSIDIARIES (“RENESAS”) PROVIDES TECHNICAL SPECIFICATIONS AND RELIABILITY DATA (INCLUDING DATASHEETS), DESIGN RESOURCES (INCLUDING REFERENCE DESIGNS), APPLICATION OR OTHER DESIGN ADVICE, WEB TOOLS, SAFETY INFORMATION, AND OTHER RESOURCES “AS IS” AND WITH ALL FAULTS, AND DISCLAIMS ALL WARRANTIES, EXPRESS OR IMPLIED, INCLUDING, WITHOUT LIMITATION, ANY IMPLIED WARRANTIES OF MERCHANTABILITY, FITNESS FOR A PARTICULAR PURPOSE, OR NON-INFRINGEMENT OF THIRD-PARTY INTELLECTUAL PROPERTY RIGHTS.

These resources are intended for developers who are designing with Renesas products. You are solely responsible for (1) selecting the appropriate products for your application, (2) designing, validating, and testing your application, and (3) ensuring your application meets applicable standards, and any other safety, security, or other requirements. These resources are subject to change without notice. Renesas grants you permission to use these resources only to develop an application that uses Renesas products. Other reproduction or use of these resources is strictly prohibited. No license is granted to any other Renesas intellectual property or to any third-party intellectual property. Renesas disclaims responsibility for, and you will fully indemnify Renesas and its representatives against, any claims, damages, costs, losses, or liabilities arising from your use of these resources. Renesas' products are provided only subject to Renesas' Terms and Conditions of Sale or other applicable terms agreed to in writing. No use of any Renesas resources expands or otherwise alters any applicable warranties or warranty disclaimers for these products.

(Disclaimer Rev.1.01 Jan 2024)

### Corporate Headquarters

TOYOSU FORESIA, 3-2-24 Toyosu,  
Koto-ku, Tokyo 135-0061, Japan  
[www.renesas.com](http://www.renesas.com)

### Trademarks

Renesas and the Renesas logo are trademarks of Renesas Electronics Corporation. All trademarks and registered trademarks are the property of their respective owners.

### Contact Information

For further information on a product, technology, the most up-to-date version of a document, or your nearest sales office, please visit [www.renesas.com/contact-us/](http://www.renesas.com/contact-us/).