

E2 Emulator RTE0T00020KCE00000R User's Manual

All information contained in these materials, including products and product specifications, represents information on the product at the time of publication and is subject to change by Renesas Electronics Corporation without notice. Please review the latest information published by Renesas Electronics Corporation through various means, including the Renesas Electronics Corporation website (<http://www.renesas.com>).

Notice

1. Descriptions of circuits, software and other related information in this document are provided only to illustrate the operation of semiconductor products and application examples. You are fully responsible for the incorporation or any other use of the circuits, software, and information in the design of your product or system. Renesas Electronics disclaims any and all liability for any losses and damages incurred by you or third parties arising from the use of these circuits, software, or information.
2. Renesas Electronics hereby expressly disclaims any warranties against and liability for infringement or any other claims involving patents, copyrights, or other intellectual property rights of third parties, by or arising from the use of Renesas Electronics products or technical information described in this document, including but not limited to, the product data, drawings, charts, programs, algorithms, and application examples.
3. No license, express, implied or otherwise, is granted hereby under any patents, copyrights or other intellectual property rights of Renesas Electronics or others.
4. You shall not alter, modify, copy, or reverse engineer any Renesas Electronics product, whether in whole or in part. Renesas Electronics disclaims any and all liability for any losses or damages incurred by you or third parties arising from such alteration, modification, copying or reverse engineering.
5. Renesas Electronics products are classified according to the following two quality grades: "Standard" and "High Quality". The intended applications for each Renesas Electronics product depends on the product's quality grade, as indicated below.
"Standard": Computers; office equipment; communications equipment; test and measurement equipment; audio and visual equipment; home electronic appliances; machine tools; personal electronic equipment; industrial robots; etc.
"High Quality": Transportation equipment (automobiles, trains, ships, etc.); traffic control (traffic lights); large-scale communication equipment; key financial terminal systems; safety control equipment; etc.
Unless expressly designated as a high reliability product or a product for harsh environments in a Renesas Electronics data sheet or other Renesas Electronics document, Renesas Electronics products are not intended or authorized for use in products or systems that may pose a direct threat to human life or bodily injury (artificial life support devices or systems; surgical implantations; etc.), or may cause serious property damage (space system; undersea repeaters; nuclear power control systems; aircraft control systems; key plant systems; military equipment; etc.). Renesas Electronics disclaims any and all liability for any damages or losses incurred by you or any third parties arising from the use of any Renesas Electronics product that is inconsistent with any Renesas Electronics data sheet, user's manual or other Renesas Electronics document.
6. When using Renesas Electronics products, refer to the latest product information (data sheets, user's manuals, application notes, "General Notes for Handling and Using Semiconductor Devices" in the reliability handbook, etc.), and ensure that usage conditions are within the ranges specified by Renesas Electronics with respect to maximum ratings, operating power supply voltage range, heat dissipation characteristics, installation, etc. Renesas Electronics disclaims any and all liability for any malfunctions, failure or accident arising out of the use of Renesas Electronics products outside of such specified ranges.
7. Although Renesas Electronics endeavors to improve the quality and reliability of Renesas Electronics products, semiconductor products have specific characteristics, such as the occurrence of failure at a certain rate and malfunctions under certain use conditions. Unless designated as a high reliability product or a product for harsh environments in a Renesas Electronics data sheet or other Renesas Electronics document, Renesas Electronics products are not subject to radiation resistance design. You are responsible for implementing safety measures to guard against the possibility of bodily injury, injury or damage caused by fire, and/or danger to the public in the event of a failure or malfunction of Renesas Electronics products, such as safety design for hardware and software, including but not limited to redundancy, fire control and malfunction prevention, appropriate treatment for aging degradation or any other appropriate measures. Because the evaluation of microcomputer software alone is very difficult and impractical, you are responsible for evaluating the safety of the final products or systems manufactured by you.
8. Please contact a Renesas Electronics sales office for details as to environmental matters such as the environmental compatibility of each Renesas Electronics product. You are responsible for carefully and sufficiently investigating applicable laws and regulations that regulate the inclusion or use of controlled substances, including without limitation, the EU RoHS Directive, and using Renesas Electronics products in compliance with all these applicable laws and regulations. Renesas Electronics disclaims any and all liability for damages or losses occurring as a result of your noncompliance with applicable laws and regulations.
9. Renesas Electronics products and technologies shall not be used for or incorporated into any products or systems whose manufacture, use, or sale is prohibited under any applicable domestic or foreign laws or regulations. You shall comply with any applicable export control laws and regulations promulgated and administered by the governments of any countries asserting jurisdiction over the parties or transactions.
10. It is the responsibility of the buyer or distributor of Renesas Electronics products, or any other party who distributes, disposes of, or otherwise sells or transfers the product to a third party, to notify such third party in advance of the contents and conditions set forth in this document.
11. This document shall not be reprinted, reproduced or duplicated in any form, in whole or in part, without prior written consent of Renesas Electronics.
12. Please contact a Renesas Electronics sales office if you have any questions regarding the information contained in this document or Renesas Electronics products.

(Note 1) "Renesas Electronics" as used in this document means Renesas Electronics Corporation and also includes its directly or indirectly controlled subsidiaries.

(Note 2) "Renesas Electronics product(s)" means any product developed or manufactured by or for Renesas Electronics.

Preface

The E2 emulator (RTE0T00020KCE00000R; hereafter referred to as the E2) is designed for use with the devices made by Renesas Electronics.

All components of the E2 are listed under “1.1 Package Components”. If you have any questions about the E2, contact your local distributor.

Documentation for the E2 manual is in three parts. In using the E2, please be sure to read each of them.

- The E2 emulator user’s manual (this manual)
- The additional documents for user’s manual for E1/E20 emulator, E2 emulator Lite, or E2 emulator (for each MCU)
- Application notes (extended functionality)

This user’s manual describes mainly the hardware specifications of the E2. For information on emulator debuggers and other related products, please see the additional document for user’s manuals and application notes included with each product.

You can download the latest manuals from the Renesas Tools homepage.

<http://www.renesas.com/e2>

Important

Before using the emulator, be sure to read this user's manual carefully.
Keep this user's manual, and refer to it when you have questions about the emulator.

Emulator:

"Emulator" in this user's manual collectively refers to the E2 emulator manufactured by Renesas Electronics Corporation.

"Emulator" herein encompasses neither the customer's user system nor the host machine.

Purpose of use of the emulator:

This emulator is a device to support the development of systems that uses the Renesas microcomputers. It provides support for system development in both software and hardware. By using in combination with a programming software, it is available as a flash programming tool.

Be sure to use the emulator correctly according to said purpose of use. Please avoid using the emulator other than for its intended purpose of use.

For those who use the emulator:

The emulator can only be used by those who have carefully read the user's manual and know how to use it.

Use of the emulator requires basic knowledge of electric circuits, logical circuits, and MCUs.

When using the emulator:

- (1) The emulator is a development-support unit for use in your program development and evaluation stages. When a program you have finished developing is to be incorporated in a mass-produced product, the judgment as to whether it can be put to practical use is entirely your own responsibility, and should be based on evaluation of the device on which it is installed and other experiments.
- (2) In no event shall Renesas Electronics Corporation be liable for any consequence arising from the use of the emulator.
- (3) Renesas Electronics Corporation strives to provide workarounds for and correct trouble with products malfunctions, with some free and some incurring charges. However, this does not necessarily mean that Renesas Electronics Corporation guarantees the provision of a workaround or correction under any circumstances.
- (4) The emulator covered by this document has been developed on the assumption that it will be used for program development and evaluation in laboratories. Therefore, it does not fall within the scope of applicability of the Electrical Appliance and Material Safety Law and protection against electromagnetic interference when used in Japan.
- (5) Renesas Electronics Corporation cannot predict all possible situations and possible cases of misuse that carry a potential for danger. Therefore, the warnings in this user's manual and the warning labels attached to the emulator do not necessarily cover all such possible situations and cases. The customer is responsible for correctly and safely using the emulator.
- (6) This emulator has acquired the standards shown in "1.5 Regulatory Compliance Notices". This fact must be taken into account when the emulator is taken from Japan to some other country.
- (7) Renesas Electronics Corporation will not assume responsibility of direct or indirect damage caused by an accidental failure or malfunction in the emulator.

When disposing the emulator:

Penalties may be applicable for incorrect disposal of this waste, in accordance with your national legislation.

Usage restrictions:

The emulator has been developed as a means of supporting system development by users. Therefore, do not use it as an embedded device in other equipment. Also, do not use it to develop systems or equipment for use in the following fields.

- (1) Transportation and vehicular
- (2) Medical (equipment that has an involvement in human life)
- (3) Aerospace
- (4) Nuclear power control
- (5) Undersea repeaters

If you are considering the use of the emulator for one of the above purposes, please be sure to consult your local distributor.

About product changes:

We are constantly making efforts to improve the design and performance of our product. Therefore, the specification or design of the emulator, or this user's manual, may be changed without prior notice.

About rights:

- (1) We assume no responsibility for any damage or infringement on patent rights or any other rights arising from the use of any information, products or circuits presented in this user's manual.
- (2) The information or data in this user's manual does not implicitly or otherwise grant a license to patent rights or any other rights belonging to Renesas or to a third party.
- (3) This user's manual and the emulator are copyrighted, with all rights reserved by Renesas. This user's manual may not be copied, duplicated or reproduced, in whole or part, without prior written consent from Renesas.

About diagrams:

Some diagrams in this user's manual may differ from the objects they represent.

Precautions for Safety

This chapter, by showing the relevant diagrammatic symbols and their meanings, describes the precautions which should be taken in order to use this product safely and properly. Be sure to read and understand this chapter before using this product.

Contact us if you have any questions about the precautions described here.



WARNING

WARNING indicates a potentially dangerous situation that will cause death or heavy wound unless it is avoided.



CAUTION

CAUTION indicates a potentially dangerous situation that will cause a slight injury or a medium-degree injury or property damage unless it is avoided.

To avoid a possible danger, the following diagrammatic symbols are used to call your attention.

△ means WARNING or CAUTION.

Example:



CAUTION AGAINST AN ELECTRIC SHOCK

⊘ means PROHIBITION.

Example:



DISASSEMBLY PROHIBITED

● means A FORCIBLE ACTION.

Example:



UNPLUG THE POWER CABLE FROM THE RECEPTACLE.

 **WARNING****Warnings for AC Power Supply:**

Do not repair or remodel the emulator product by yourself in order to prevent danger such as an electric shock or fire and for the sake of quality assurance. For after-sale services in case of a mechanical or electrical fault, please contact your local distributor.

Always switch off the Host machine and user system before connecting or disconnecting any cables or parts. Neglect of this precaution will result in getting an electric shock or will result in the emulator product or user system emitting smoke or catching fire. Also, the user program under debug will be destroyed.

Make sure that the connectors on both ends of the user-system interface cable are facing the right way relative to the user-side connector on the emulator and the connector on the user system, respectively. Neglect of this precaution will result in getting an electric shock or will result in the emulator product or user system emitting smoke or catching fire.

Warning for Modification:

Do not modify the emulator. Personal injury due to electric shock may occur if the emulator is modified. Modifying the product will void your warranty.

Warning for Installation:

Do not set the emulator in water or areas of high humidity. Make sure that the product does not get wet. Spilling water or some other liquid into the product may cause un-repairable damage.

Warning for Use temperature:

The emulator is to be used in an environment with a maximum ambient temperature of 35°C. Care should be taken that this temperature is not exceeded.

 **CAUTION**
Caution to Be Taken for Handling the Emulator:

Exercise caution when handling the emulator. Be careful not to apply a mechanical shock.

Do not touch the connector pins of the emulator and the target MCU connector pins directly. Static electricity may damage the internal circuits.

When attaching and removing the cable, hold the plug of the cable and do not touch the cable. When installing the emulator, do not flex the cable excessively or pull the emulator or the board by the cable connected to it. The cable may cause a break.

Do not tape the flexible cable or apply adhesives to secure the cable. The shielding material on the surface of the cable may come off.

Caution to Be Taken for System Malfunctions:

If the emulator malfunctions because of interference like external noise, do the following to remedy the trouble.

(1) Exit the emulator debugger, and shut OFF the emulator and the user system.

(2) After a lapse of 10 seconds, turn ON the power of the emulator and the user system again, then launch the emulator debugger.

Caution to Be Taken for Disposal:

Penalties may be applicable for incorrect disposal of this waste, in accordance with your national legislation.

European Union regulatory notices:

The WEEE (Waste Electrical and Electronic Equipment) regulations put responsibilities on producers for the collection and recycling or disposal of electrical and electronic waste. Return of WEEE under these regulations is applicable in the European Union only. This equipment (including all accessories) is not intended for household use. After use the equipment cannot be disposed of as household waste, and the WEEE must be treated, recycled and disposed of in an environmentally sound manner.



Renesas Electronics Europe GmbH can take back end of life equipment, register for this service at "<http://www.renesas.eu/weee>"

Contents

	Page
Preface.....	3
Important.....	4
Precautions for Safety	6
Contents	9
Terminology	10
1. Outline	11
1.1. Package Components	11
1.2. System Configuration	12
1.3. PC Interface.....	13
1.4. Specifications.....	14
1.5. Regulatory Compliance Notices	15
1.5.1. European Union regulatory notices.....	15
1.5.2. United States regulatory notices	15
1.6. E2 Hardware Configuration	16
1.7. Names of the Emulator Parts	17
1.8. Operating Environment.....	18
2. Setup	19
2.1. Installing Emulator Software.....	19
2.2. Connecting the E2 to the Host Machine.....	19
2.3. Connecting the E2 to the User System	20
2.4. Hot plug-in	23
2.5. Turning the Power On/Off.....	25
2.5.1. When a Separate Power Supply is Used for the User System.....	25
2.5.2. When Power is Supplied to the User System from the Emulator	26
2.6. Connecting System Ground	27
3. Troubleshooting (Action in Case of an Error)	28
3.1. How to Solve a Trouble	28
3.1.1. The ACTIVE LED does not flash or light up.....	28
3.1.2. Unconnectable with the debugger.....	28
3.2. How to Request Support	28
4. Maintenance and Warranty	29
4.1. Maintenance	29
4.2. Warranty	29
4.3. Repair Provisions.....	29
4.4. How to Make Request for Repair	30
Appendix.....	31
A E2 Self-Checking Program (SCP).....	31
A.1 Flow of Self-Checking	31
A.2 Preparations for Self-Checking.....	32
A.3 Executing the SCP.....	33
B E2 Expansion Interface	39
B.1 Pin Alignment on the Connector	39
B.2 Internal Circuit of the Emulator	40
Revision History.....	41

Terminology

Some specific words used in this user's manual are defined below.

Integrated development environment

This tool provides powerful support for the development of embedded applications for Renesas microcomputers. It has an emulator debugger function allowing the emulator to be controlled from the host machine via an interface. Furthermore, it permits a range of operations from editing a project to building and debugging it to be performed within the same application. In addition, it supports version management.

Emulator debugger

This means a software tool that is started up from the integrated development environment, and controls the emulator and enables debugging.

Programming software

This means Renesas Flash Programmer that is available on the emulator.

Host machine

This means a personal computer used to control the emulator.

Target device

This means the device to be debugged.

Target CPU

This refers to the CPU to be debugged when the target device has multiple CPUs.

User system

This means a user's application system in which the device to be debugged is used.

User program

This means the application program to be debugged.

User system interface

This means the interface that the E2 emulator connects to a user's application system.

SCP

This is an abbreviation of "self-checking program".

E2 expansion interface

This means the interface required for extended functions of the E2 emulator.

1. Outline

This chapter describes the package components, the system configuration, and the specifications of the emulator functions and operating environment.

1.1. Package Components

The E2 package consists of the following items. After you have unpacked the box, check if your E2 contains all of these items. Table 1.1 shows the packing components for the E2.

Table 1.1 Package Components for the E2

Item	Description	Quantity
RTE0T00020KCE00000R	E2 emulator main unit	1
USB interface cable	A plug — mini-B plug, 1.5 m, compliant with high-speed standard	1
User-system interface cable (RTE0T00020KCAC0000J) *1	20-pin (1.27-mm pitch) flat cable, 150 mm	1
Conversion adapter (RTE0T00020KCA00000R) *2	20-pin (1.27-mm pitch) to 14-pin (2.54-mm pitch) connector conversion adapter	1
Test leads	Test leads with clips, 300 mm	4

Notes: 1. You can also purchase the user-system interface cable separately.

2. You can also purchase the conversion adapter separately.

Please keep the E2 emulator's packing box at hand for later reuse in sending the product for repairs or for other purposes. Always use the original packing box when transporting the E2. If packing of your product is not complete, it may be damaged during transportation.

1.2. System Configuration

The E2 is used by connecting it to the target device mounted on the user system.

Figure 1.1 shows the configuration of the E2 system.

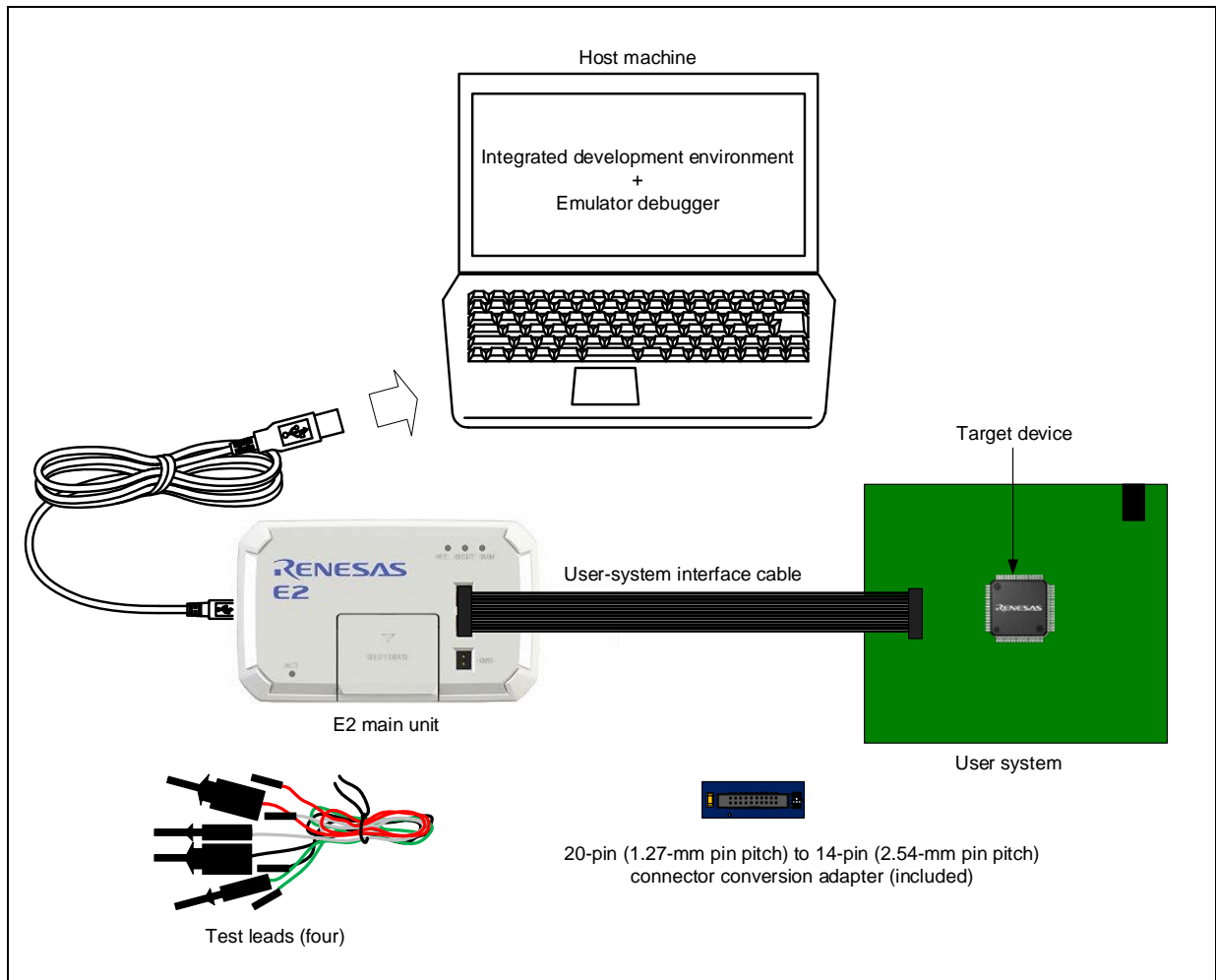

Figure 1.1 System Configuration of E2

- (1) E2 main unit (this product)
- (2) USB interface cable (included)
- (3) User-system interface cable (included)
- (4) User system
This is your application system on which the target device or target CPU for debugging is mounted.
- (5) Host machine
A personal computer to control the E2 by USB interface.
- (6) Conversion adapter
A conversion adapter is used for connection to user system with connectors other than the 20-pin (1.27-mm pitch) connector due to the type of target device or the characteristics of the user system.
 - 20-pin (1.27-mm pitch) to 14-pin (2.54-mm pitch) connector conversion adapter (included)
 - Conversion adapters other than the above (separately available)
- (7) Four test leads (included)
These leads are used for extended functions.

1.3. PC Interface

- USB Interface*

USB 2.0 high speed (also connectable to USB 1.1- and USB 3.0-compatible host machines)

Note: Operation with all combinations of host machine, USB device, and USB hub is not guaranteed. The A plug of the USB interface cable is used for the PC interface.

1.4. Specifications

Table 1.2 lists the specifications of the E2.

Table 1.2 Specifications of the E2

Item	Description
Emulator type	E2 emulator Type name: RTE0T00020KCE00000R
PC interface	USB 2.0 (high speed/full speed)
User-system interface	20-pin (1.27-mm pitch) connector Micro-header (1.27-mm/0.50" pitch) from Samtec Part number: FTSH-110-01-L-DV-K When using the conversion adapter: 14-pin (2.54-mm pitch) connector 7614-6002 from 3M Japan Limited (in Japan) 2514-6002 from 3M Limited (in other countries)
E2 expansion interface	The E2 can be expanded by using the self-check connector with 14 pins at a pitch of 2.54 mm to connect it to other equipment. <ul style="list-style-type: none"> - Input and output pins: 12 - Power supply pin: 1 - GND pin: 1 For details, refer to the additional documents for user's manual for the E1/E20 emulator, E2 emulator Lite, or E2 emulator, and to application notes.
Power voltage for the emulator	USB-bus power supply (VBUS 4.5 V min. / 500 mA max.)
Power supply for the target device	Supplied from the user system or the emulator (200 mA max. *)
Supported voltages for the user system	Within 1.8 V to 5.0 V, and in the range of the MCU's power supply voltage while in operation. For more information, see the additional document for user's manual for the E1/E20 emulator, E2 emulator Lite, or E2 emulator.
Supported voltages for the E2 expansion interface	Within 1.8 V to 5.0 V, and in the range of the MCU's power supply voltage while in operation. For details, refer to the additional documents for user's manual for the E1/E20 emulator, E2 emulator Lite, or E2 emulator, and to application notes.
External dimension (main body)	105.9 mm × 64.0 mm × 19.5 mm
Weight	75 g (not including cables)
Operating temperature	5 to 35°C (no condensation)
Storage temperature	-10 to 60°C (no condensation)
EMC	EU: EN 55032 Class A, EN 55024 USA: FCC part 15 Class A

Note: When 500 mA is supplied from USB VBUS

1.5. Regulatory Compliance Notices

1.5.1. European Union regulatory notices

This product complies with the following EU Directives. (These directives are only valid in the European Union.)

CE Certifications:

- Electromagnetic Compatibility (EMC) Directive 2014/30/EU
EN 55032 Class A

WARNING: This is a Class A product. This equipment can cause radio frequency noise when used in the residential area. In such cases, the user/operator of the equipment may be required to take appropriate countermeasures under his responsibility.

EN 55024

- Information for traceability
 - Authorized representative & Manufacturer
 - Name: Renesas Electronics Corporation
 - Address: TOYOSU FORESIA, 3-2-24, Toyosu, Koto-ku, Tokyo 135-0061, Japan
 - Person responsible for placing on the market
 - Name: Renesas Electronics Europe GmbH
 - Address: Arcadiastrasse 10, 40472 Dusseldorf, Germany
 - Trademark and Type name
 - Trademark: Renesas
 - Product name: E2 Emulator
 - Type name: RTE0T00020KCE00000R

Environmental Compliance and Certifications:

- Waste Electrical and Electronic Equipment (WEEE) Directive 2012/19/EU

1.5.2. United States regulatory notices

This product complies with the following EMC regulation. (This is only valid in the United States.)

FCC Certifications:

This equipment has been tested and found to comply with the limits for a Class A digital device, pursuant to Part 15 of the FCC Rules. These limits are designed to provide reasonable protection against harmful interference when the equipment is operated in a commercial environment. This equipment generates, uses, and can radiate radio frequency energy and, if not installed and used in accordance with the instruction manual, may cause harmful interference to radio communications. Operation of this equipment in a residential area is likely to cause harmful interference in which case the user will be required to correct the interference at his own expense.

This device complies with Part 15 of the FCC Rules. Operation is subject to the following two conditions: (1) this device may not cause harmful interference, and (2) this device must accept any interference received, including interference that may cause undesired operation.

CAUTION: Changes or modifications not expressly approved by the party responsible for compliance could void the user's authority to operate the equipment.

1.6. E2 Hardware Configuration

As shown in Figure 1.2, the E2 consists of the E2 main unit, a USB interface cable, and a user-system interface cable. The emulator is connectable to the host machine via a USB port compliant with USB 2.0 (Full-Speed or High-Speed), USB 1.1 or USB 3.0.

In some user systems to be debugged, it is possible to use the included 20-pin (1.27-mm pitch) to 14-pin (2.54-mm pitch) connector conversion adapter and the test leads.

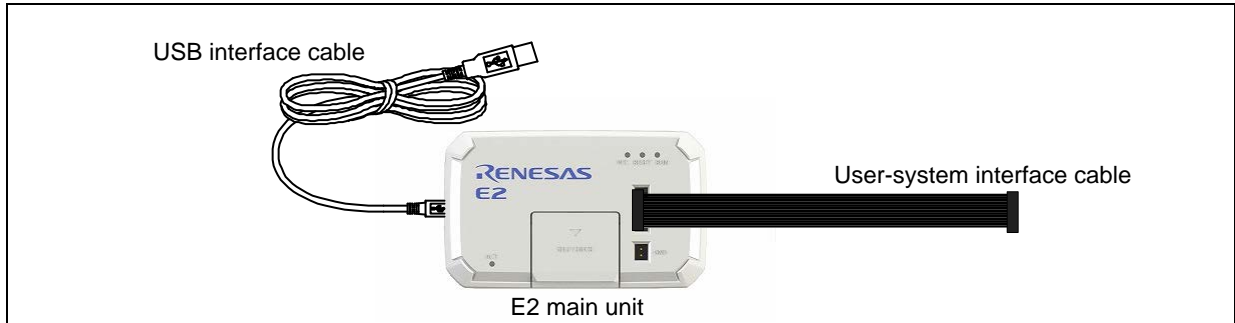

Figure 1.2 E2 Hardware Configuration

1.7. Names of the Emulator Parts

The names of the parts of the emulator are given in Figure 1.3 and Figure 1.4, while those of the conversion adapter are given in Figure 1.5.

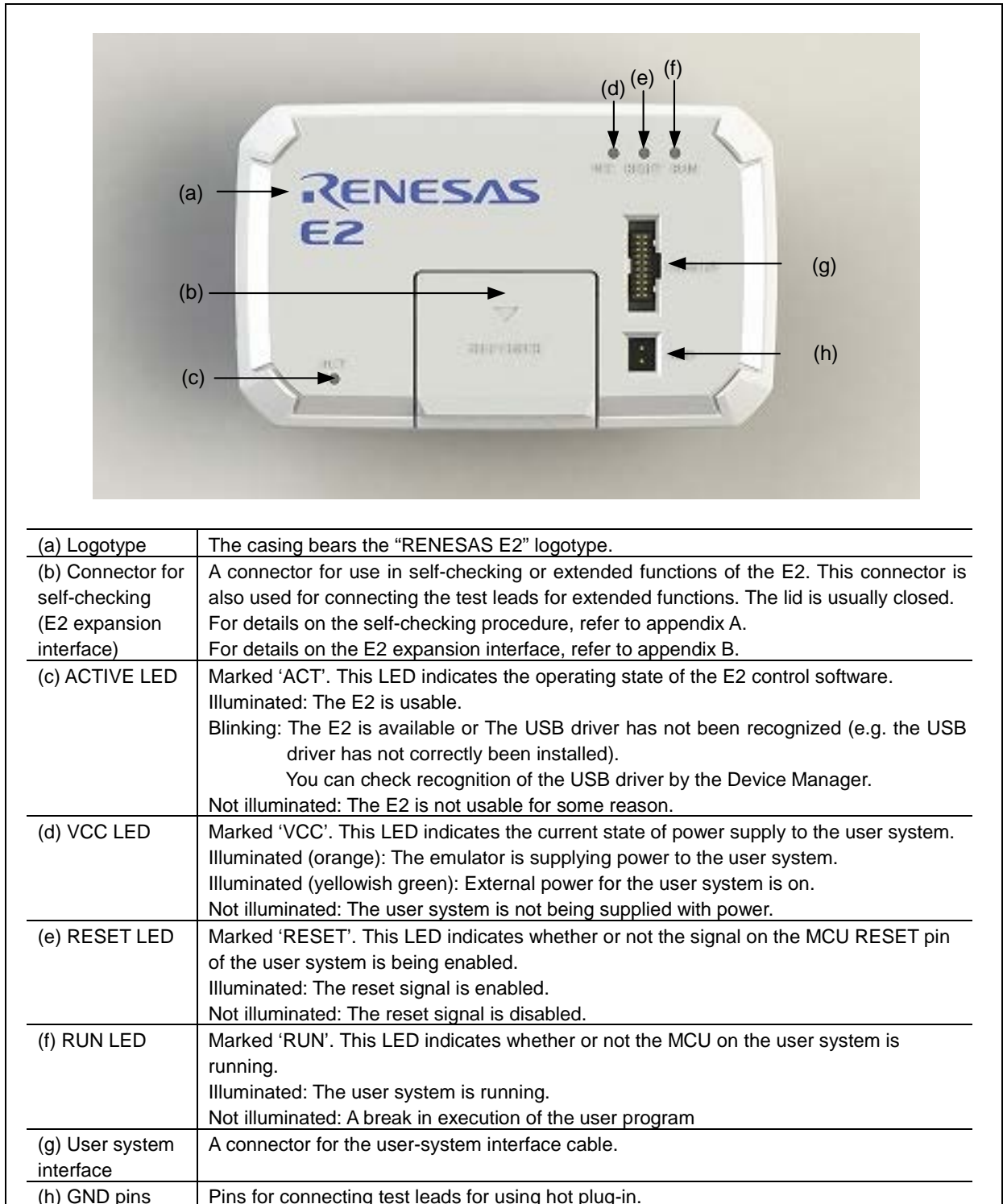

Figure 1.3 E2 Top View

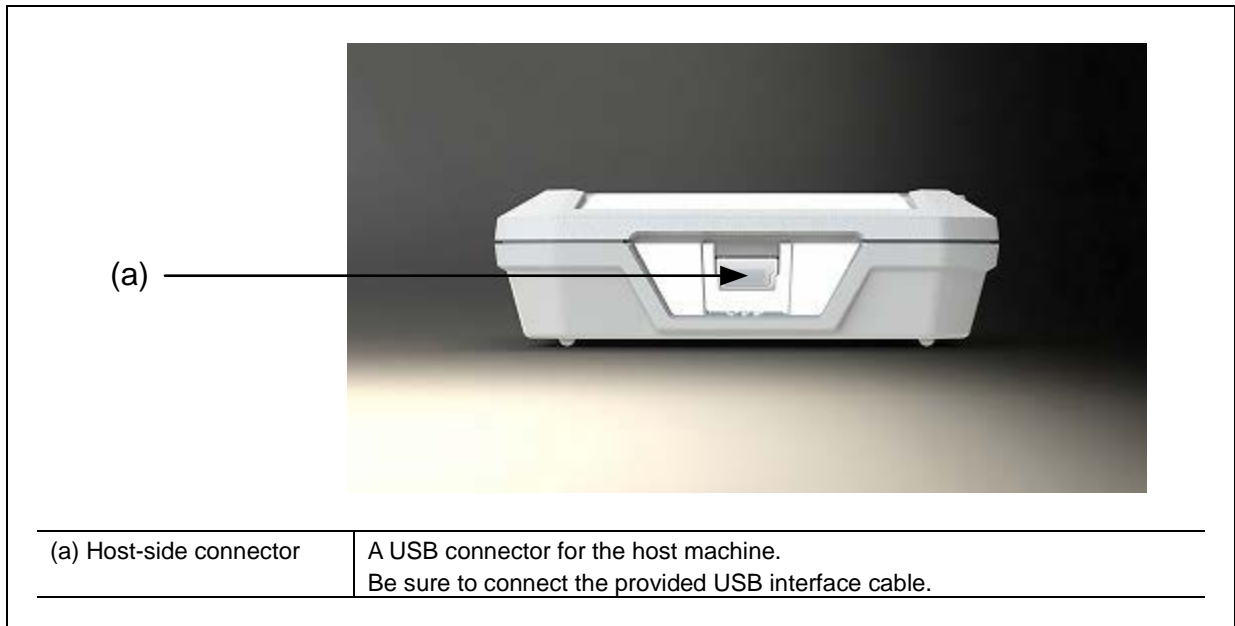
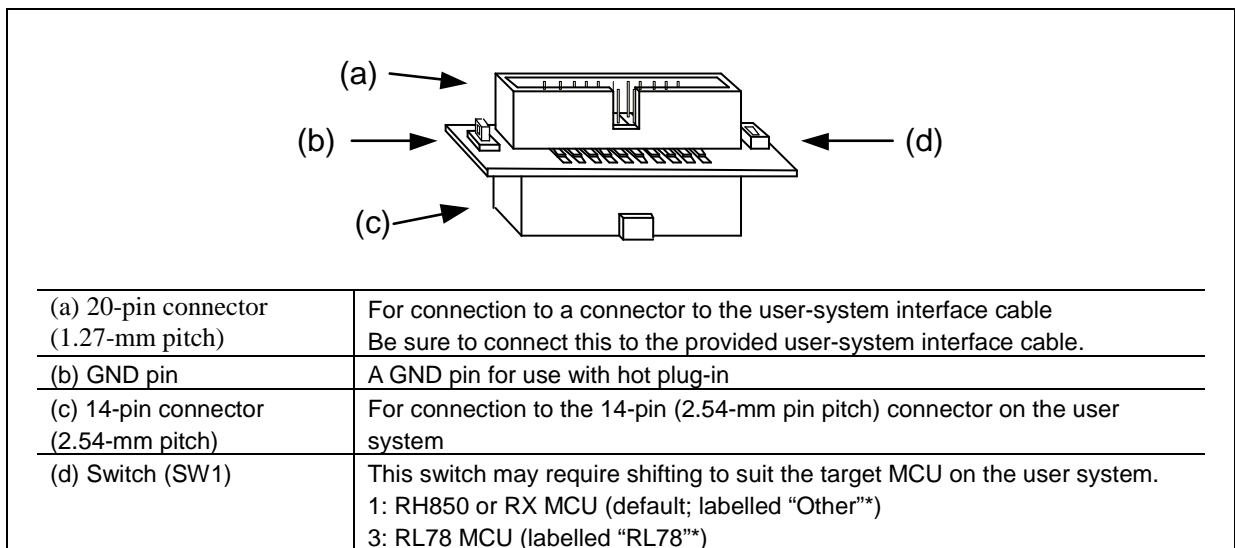

Figure 1.4 E2 Host-Side View



*: These are not printed on some versions of the conversion adapter.

Figure 1.5 20-Pin (1.27-mm Pin Pitch) to 14-Pin (2.54-mm Pin Pitch) Connector Conversion Adapter

1.8. Operating Environment

Observe the conditions listed in Table 1.3 when using the emulator.

Table 1.3 Operating Environmental Conditions

Item	Description
Temperature	Operating: +5°C to +35°C Storage: -10°C to +60°C
Humidity	35% RH to 80% RH, no condensation
Vibration	Operating: 2.45 m/s ² max. Storage: 4.9 m/s ² max. Transportation: 14.7 m/s ² max.
Ambient gases	No corrosive gases may be present.

2. Setup

2.1. Installing Emulator Software

If you are using the E2, download and install the latest integrated development environment or flash memory programming software from the following Web site.

<https://www.renesas.com/e2-download>

2.2. Connecting the E2 to the Host Machine

Use the USB interface cable supplied with the product to connect the E2 to the host machine as shown in Figure 2.1. For the position of each connector of the E2, refer to section 1.7, Names of the Emulator Parts.

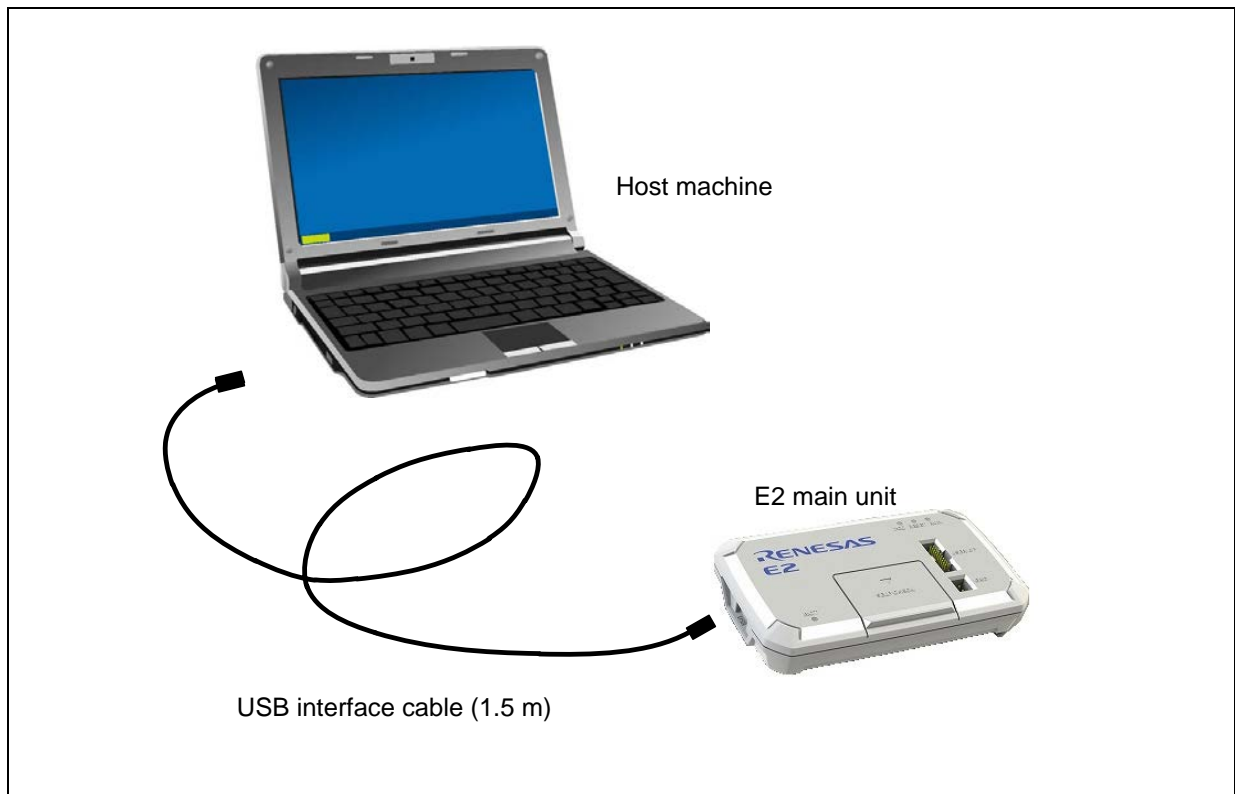

Figure 2.1 System Configuration when Connecting the E2 to the Host Machine

- (1) Connect the A plug of the USB interface cable to the USB interface connector of the host machine.
- (2) Connect the mini-B plug of the USB interface cable to the USB interface connector of the E2.

The USB interface cable included with the product conforms to the USB 2.0 high-speed standard. When you use the E2, be sure to use the USB interface cable supplied with it.

The E2 is turned on by connecting the USB interface cable.

The USB driver is included in the installation of the integrated development environment from Renesas (e.g. CS+ or the e2 studio). If you are using an integrated development environment not from Renesas, please contact a Renesas Electronics representative or distributor.

If the USB port of the host machine or the emulator to be connected is changed, the USB driver will recognize the device again.

2.3. Connecting the E2 to the User System

Use the procedure below to connect the E2 to the user system with the user-system interface cable, or to disconnect them when moving the E2 or the user system.

- (1) Connect the user-system interface cable to the upper-side connector of the E2.
When connecting the user-system interface cable to the E2, check the position of the erroneous insertion prevention key to ensure that the cable is plugged in correctly.

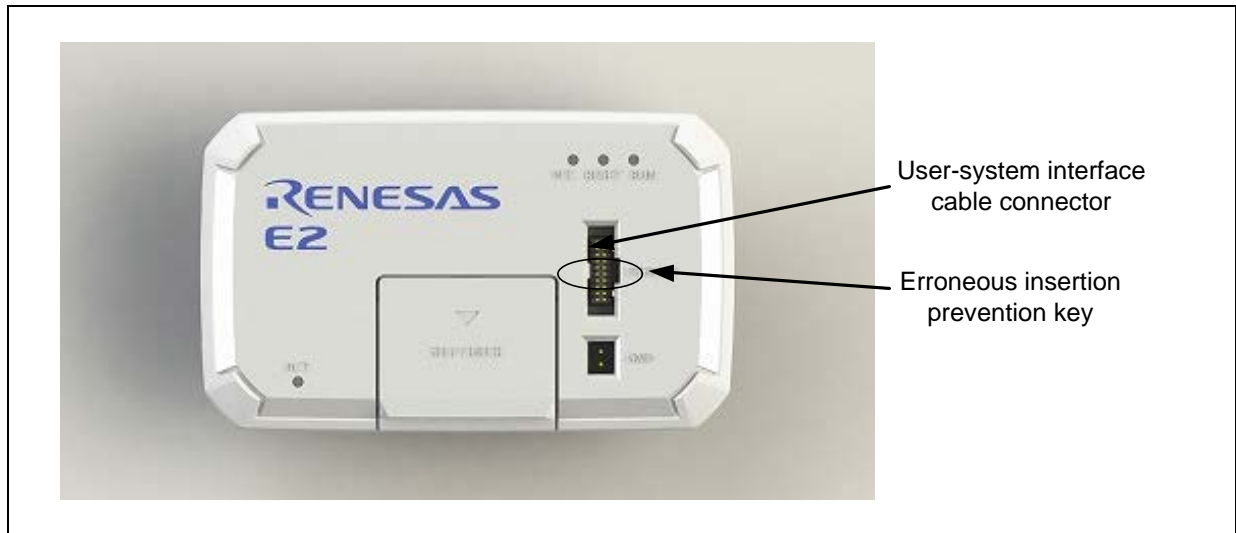

Figure 2.2 User-System Interface Cable Connector on the E2

- (2) A connector to the user-system interface cable must be installed on the user system. Table 2.1 shows the recommended connector for the emulator.

Table 2.1 Recommended Connector

Connector	Type Number	Manufacturer	Specifications
20-pin (1.27-mm pitch) connector	FTSH-110-01-L-DV-K	Samtec	20-pin surface-mount straight type
14-pin (2.54-mm pitch) connector	7614-6002	3M Japan Limited	14-pin straight type (Japan)
	2514-6002	3M Limited	14-pin straight type (other countries)

- (3) For the pin assignments of the connector, refer to the additional document for user's manual for the E1/E20 emulator, E2 emulator Lite, or E2 emulator which corresponds to the target MCU.
- (4) Connect one end of the user-system interface cable to the E2 and the other end to the connector on the user system as shown in Figure 2.3 and Figure 2.4.

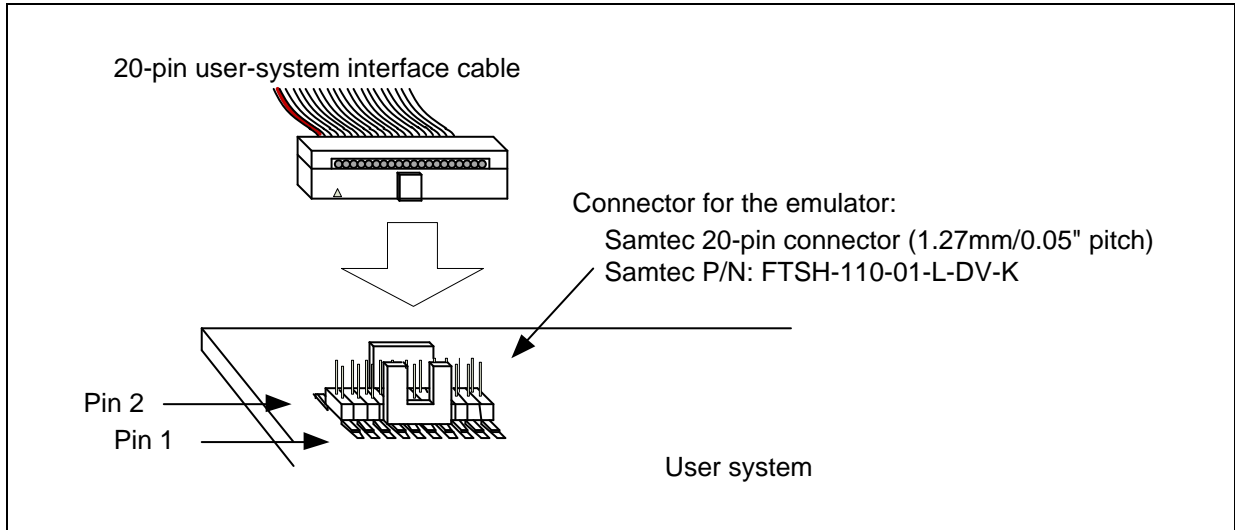

Figure 2.3 Connecting the User-System Interface Cable to the 20-Pin (1.27-mm Pitch) Connector on the User System

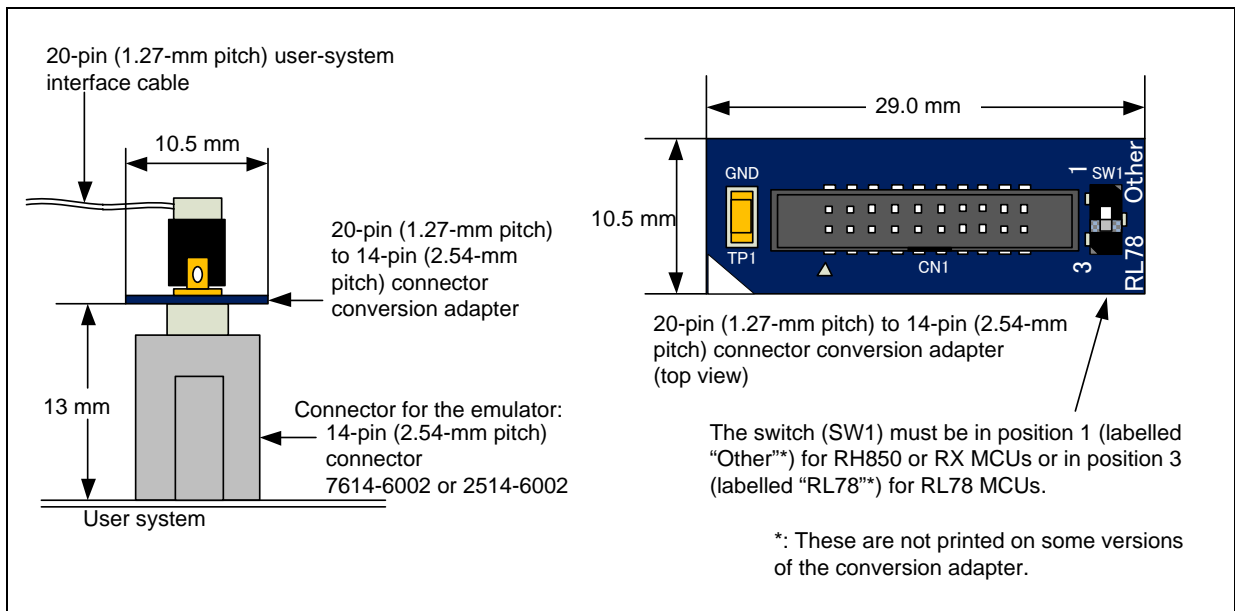

Figure 2.4 Connecting the User-System Interface Cable to the 14-Pin (2.54-mm Pitch) Connector on the User System

! CAUTION

Limit to the height on connector periphery:

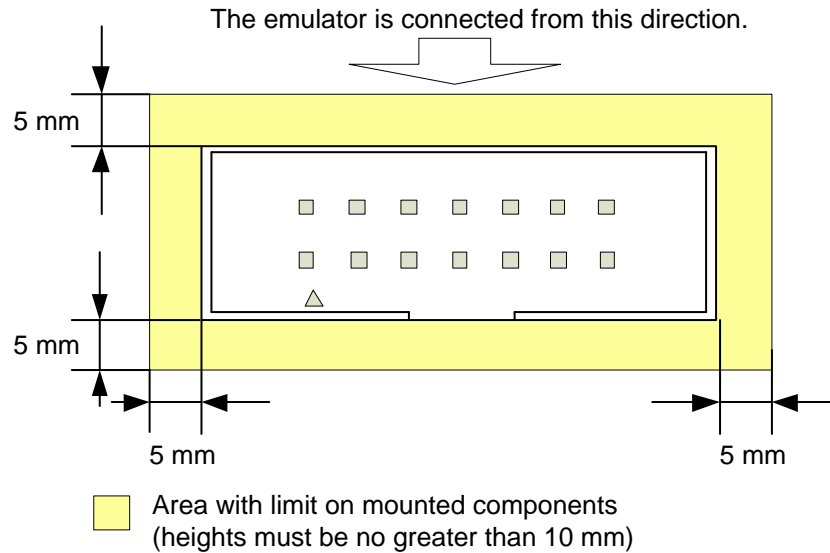

If the 20-pin (1.27-mm pitch) to 14-pin (2.54-mm pitch) connector conversion adapter is in use and other components are to be mounted in the vicinity of the 14-pin connector, do not mount components with a height of 10 mm or more on the user system within a rectangle 5 mm from the edges of the connector.

**! CAUTION**

Note on connector insertion and removal:



Be aware that the user-system interface cable or the connector conversion adapter must be inserted with the correct orientation. Connecting the user-system interface cable or the connector conversion adapter with the wrong orientation may cause damage.

2.4. Hot plug-in

Hot plug-in allows connection of an emulator with a user system which is not connected with an emulator without turning off the power to the user system, and then proceeding with debugging.

The emulator can thus be connected with a user system when a problem arises during checking of operation with the user system alone, and this makes identifying the reasons for the problem easier.

Hot plug-in of the E2 emulator can be used without the hot plug-in adapter which is sold separately for use with other emulators.

Connect the E2 and the user system with a user-system interface cable and a test lead as shown below.

- (1) Connect the user-system interface cable and the test lead to the connector on the top of the E2.

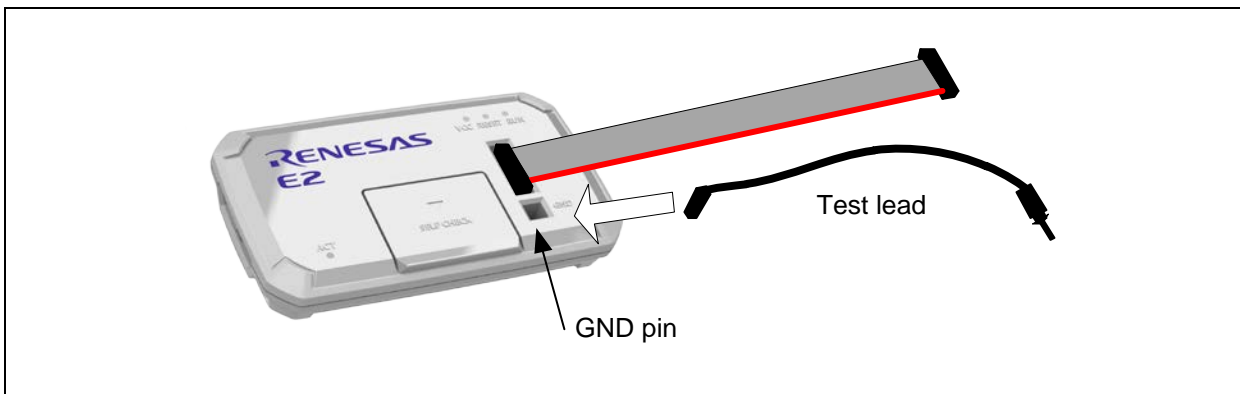

Figure 2.5 Connecting a User-System Interface Cable and a Test Lead on the E2

- (2) Start by connecting a conversion adapter to the user system, then connect the E2 and the GND pin which is on the conversion adapter with the test lead.

Connect the user-system interface cable when you are ready to proceed with hot plug-in and running the debugger.

Figure 2.6 shows the method of connection. Refer to Figure 2.7 for the method of connection when you are not using the conversion adapter.

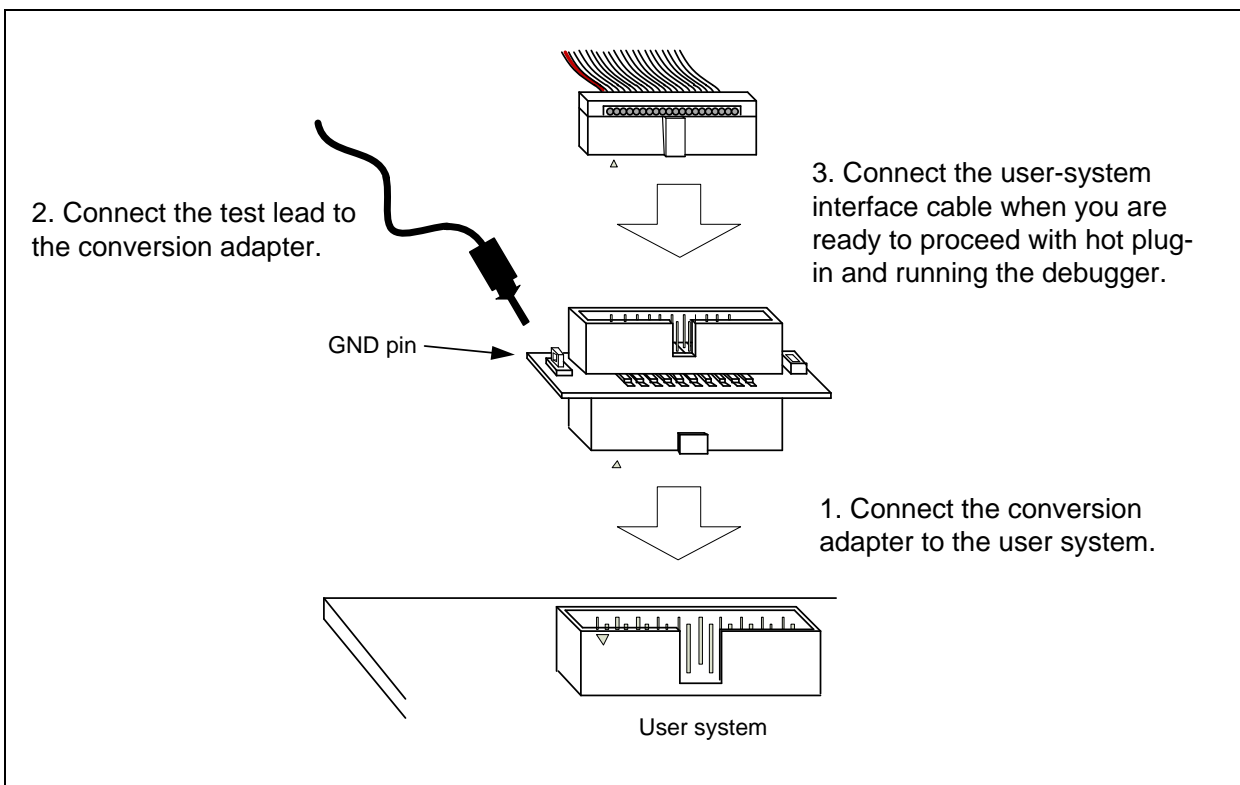

Figure 2.6 Hot Plug-in Connection

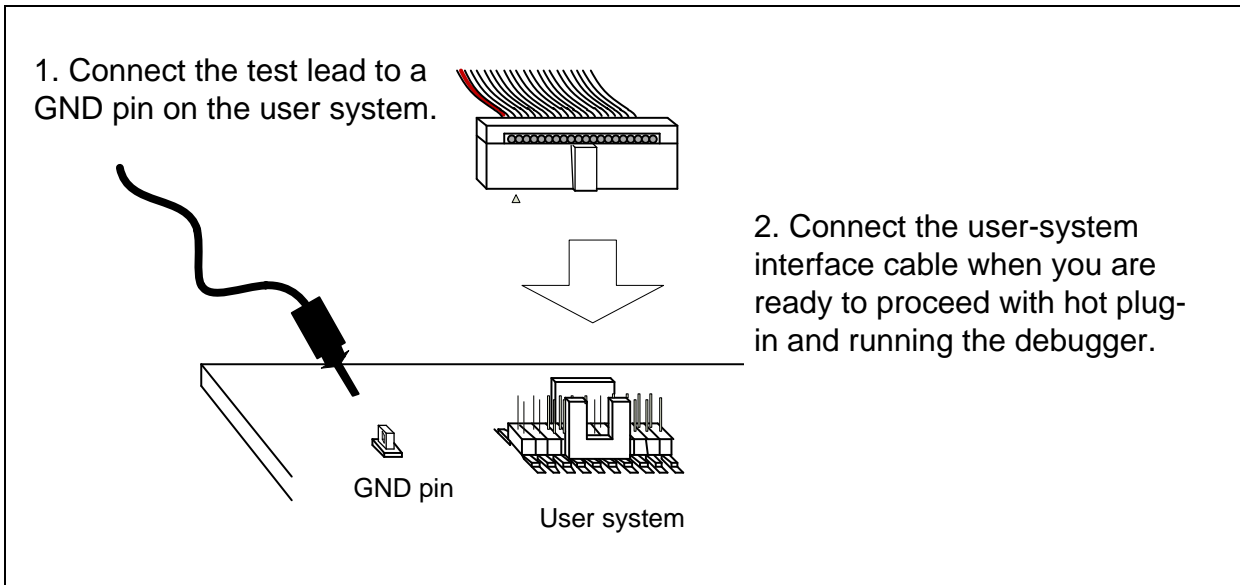

Figure 2.7 Hot Plug-in Connection (when the Conversion Adapter is not in Use)

- (3) Follow the procedure in 2.5.1 when ending a hot plug-in connection.

CAUTION



Insert the connector firmly when connecting the E2 to a user system. If it is not connected correctly, the connection may fail. Refer to the points for caution regarding hot plug-in connection which are included in the additional documents for user's manual for the E1/E20 emulator, E2 emulator Lite, or E2 emulator.

2.5. Turning the Power On/Off

Turn the power of the E2 and the user system following the procedure below.

2.5.1. When a Separate Power Supply is Used for the User System

<When using the emulator>

- (1) Check that the power is off.
Check that the user system is turned off.
- (2) Connect the user system.
Follow the instructions in "2.3 Connecting the E2 to the User System" to connect the emulator and the user system with a user-system interface cable.
- (3) Connect the host machine and turn on the emulator.
Follow the instructions in "2.2 Connecting the E2 to the Host Machine" to connect the emulator and the host machine with a USB interface cable. The E2 is turned on by connecting the USB interface cable.
- (4) Turn on the user system.
- (5) Launch the emulator debugger.

<When finished using the emulator>

- (1) Close the emulator debugger.
- (2) Turn off the user system.
- (3) Turn off and disconnect the emulator.
The E2 is turned off by disconnecting from the USB interface cable.
- (4) Disconnect the user system.
Disconnect the user-system interface cable from the user system.

CAUTION

Note on the User System Power Supply:



While the power of the user system is on, do not turn off the host machine or unplug the USB interface cable.
The user system may be damaged due to leakages current.

2.5.2. When Power is Supplied to the User System from the Emulator

<When using the emulator>

- (1) Connect the user system.

Follow the instructions in "2.3 Connecting the E2 to the User System" to connect the emulator and the user system with a user-system interface cable.

- (2) Connect the host machine and turn on the emulator.

Follow the instructions in "2.2 Connecting the E2 to the Host Machine" to connect the emulator and the user system with a user-system interface cable, then turn on the emulator.

- (3) Launch the emulator debugger and select the setting of power supply to the user system.

<When finished using the emulator>

- (1) Close the emulator debugger.

- (2) Turn off and disconnect the emulator.

Disconnect the USB interface cable from the emulator, then turn off the emulator.

- (3) Disconnect the user-system interface cable from the user system.

2.6. Connecting System Ground

The emulator's signal ground is connected to the user system's signal ground.

In the emulator, the signal ground and frame ground are connected.

In the user system, connect the frame ground only; do not connect the signal ground to the frame ground (Figure 2.8).

If it is difficult to separate the frame ground from the signal ground in the user system, set the GND for DC power input (AC adapter) of the host machine and the frame ground of the user system as the same potential. If the GND potential is different between the host machine and the user system, an overcurrent will flow in the low-impedance GND line and thin lines might be burned.

⚠ WARNING

Connecting System Ground :



Separate the frame ground from the signal ground at the user system. Failure to do so will result in smoke, fire, or an electric shock due to the difference in ground potential.

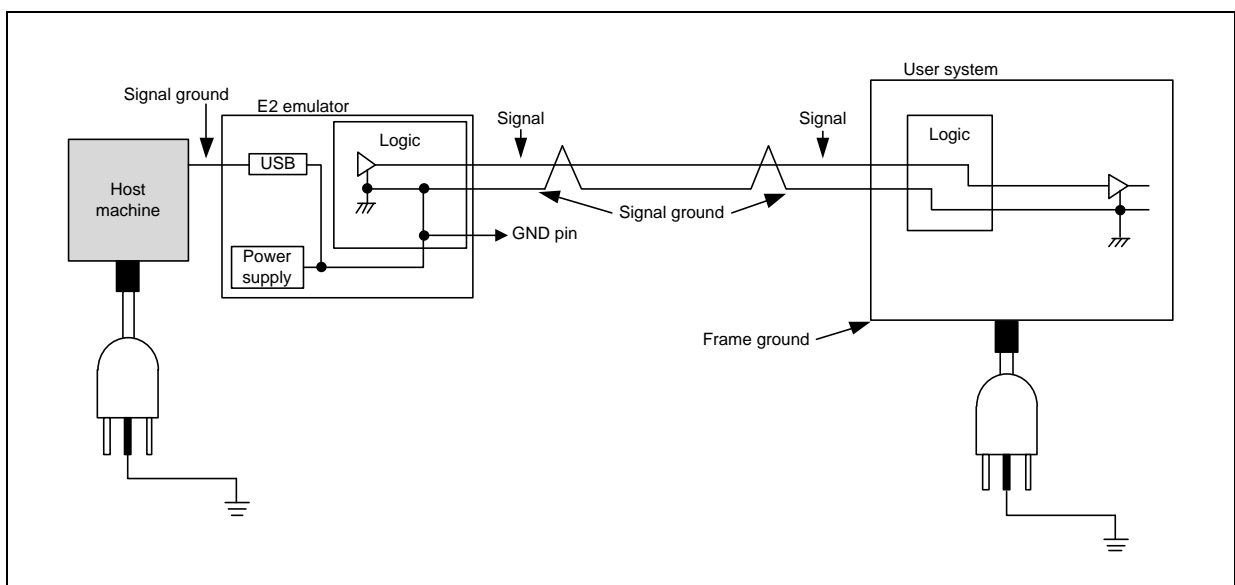

Figure 2.8 Connecting System Ground

3. Troubleshooting (Action in Case of an Error)

3.1. How to Solve a Trouble

The following describes how to solve a trouble when any problem occurs before the emulator debugger starts after power has been supplied to the emulator and the user system. For the latest information on the emulator and emulator debugger, visit Renesas Electronics' development environment website (<http://www.renesas.com/tools>).

3.1.1. The ACTIVE LED does not flash or light up

[Cases where the ACTIVE LED does not flash while a USB interface cable is connected]

This means that the E2 is in an unusable state for some reason. Check the following:

- Whether the E2 and the host machine are connected with the USB interface cable.
- Whether the power for the host machine is turned on.

[Cases where the ACTIVE LED does not light up when you connect the tools.]

The USB driver is not installed correctly in the host machine.

Install the USB driver correctly.

3.1.2. Unconnectable with the debugger

- (1) Check the connection between the emulator and the target device.

For details, refer to the additional document for user's manual for the E1/E20 emulator, E2 emulator Lite, or E2 emulator which corresponds to the target MCU.

- Whether the emulator and the target device are connected correctly.
- Whether the connected signal lines are pulled up to the power supply or down to GND properly.

- (2) Check to see that the target device is in a ready state.

- The operating clock of the target device is on (= oscillating).
- The target device is supplied with power properly.
- The target device has been reset and is ready to go.

3.2. How to Request Support

After checking the items in "Troubleshooting", contact us from the following URL.

<http://www.renesas.com/contact/>

For prompt response, please specify the following information:

- (1) Operating environment

Name of the target device: _____
 Operating frequency: _____ [MHz]
 Operating mode: _____ [Mode]

- (2) Condition

The emulator debugger starts up / does not start up
 The error is detected / not detected in the self-check
 Frequency of errors: always / frequency (_____)

- (3) Problem

4. Maintenance and Warranty

This chapter covers basic maintenance, warranty information, provisions for repair and the procedures for requesting a repair.

4.1. Maintenance

- (1) If dust or dirt collects on this product, wipe it off with a dry soft cloth. Do not use thinner or other solvents because these chemicals can cause the surface coating to separate.
- (2) When you do not use this product for a long period, disconnect it from the power supply, host machine and user system.

4.2. Warranty

- (1) This product comes with a one-year limited warranty after purchase.
Should the product break down or be damaged while you're using it under normal condition based on its user's manual, it will be repaired or replaced free of cost.
- (2) However, if the following failure or damage occurs to the product under warranty, the product will be repaired or replaced at cost.
 - a) Failure or damage attributable to the misuse or abuse of the product or its use under other abnormal conditions.
 - b) Failure or damage attributable to improper handling of the product after purchase, such as dropping of the product when it is transported or moved.
 - c) Failure or damage to the product caused by other pieces of equipment connected to it.
 - d) Failure or damage attributable to fire, earthquakes, thunderbolts, floods, or other natural disasters or abnormal voltages, etc.
 - e) Failure or damage attributable to modifications, repairs, adjustments, or other acts made to the product by other than Renesas Electronics Corporation.
- (3) Consumables (e.g., sockets and adapters) are not covered by the aforementioned repair.

In the above cases, contact your local distributor. If your product is being leased, consult the leasing company or the owner.

4.3. Repair Provisions

- (1) Repairs not covered by warranty
Problems arising in products for which more than one year has elapsed since purchase are not covered by warranty.
- (2) Replacement not covered by warranty
If your product's fault falls into any of the following categories, the fault will be corrected by replacing the entire product instead of repairing it, or you will be advised to purchase a new product, depending on the severity of the fault.
 - Faulty or broken mechanical portions
 - Flaws, separation, or rust in coated or plated portions
 - Flaws or cracks in plastic portions
 - Faults or breakage caused by improper use or unauthorized repair or modification
 - Heavily damaged electric circuits due to overvoltage, overcurrent or shorting of power supply
 - Cracks in the printed circuit board or burnt-down patterns
 - A wide range of faults that make replacement less expensive than repair
 - Faults that are not locatable or identifiable

- (3) Repair period
 - We accept requests for repairs up to three years after production of a given model has ceased.
 - Repairing a given model may become impossible even during the above period if the parts required for the repairs are no longer available.
- (4) Carriage fees for sending your product to be repaired
 - Carriage fees for sending your product to us for repair are at your own expense.

4.4. How to Make Request for Repair

If your product is found faulty, fill in a Repair Request Sheet downloadable from the following URL. And email the sheet and send the product to your local distributor.

<http://www.renesas.com/repair>

CAUTION

Note on Transporting the Product:



When sending your product for repair, use the packing box and cushioning material supplied with the product when it was delivered to you and specify caution in handling (handling as precision equipment). If packing of your product is not complete, it may be damaged during transportation. When you pack your product in a bag, make sure to use the conductive plastic bag supplied with the product (usually a blue bag). If you use a different bag, it may lead to further trouble with your product due to static electricity.

Appendix

A E2 Self-Checking Program (SCP)

This chapter gives the procedure for using the self-checking program (SCP) for the E2 in fault analysis.

A.1 Flow of Self-Checking

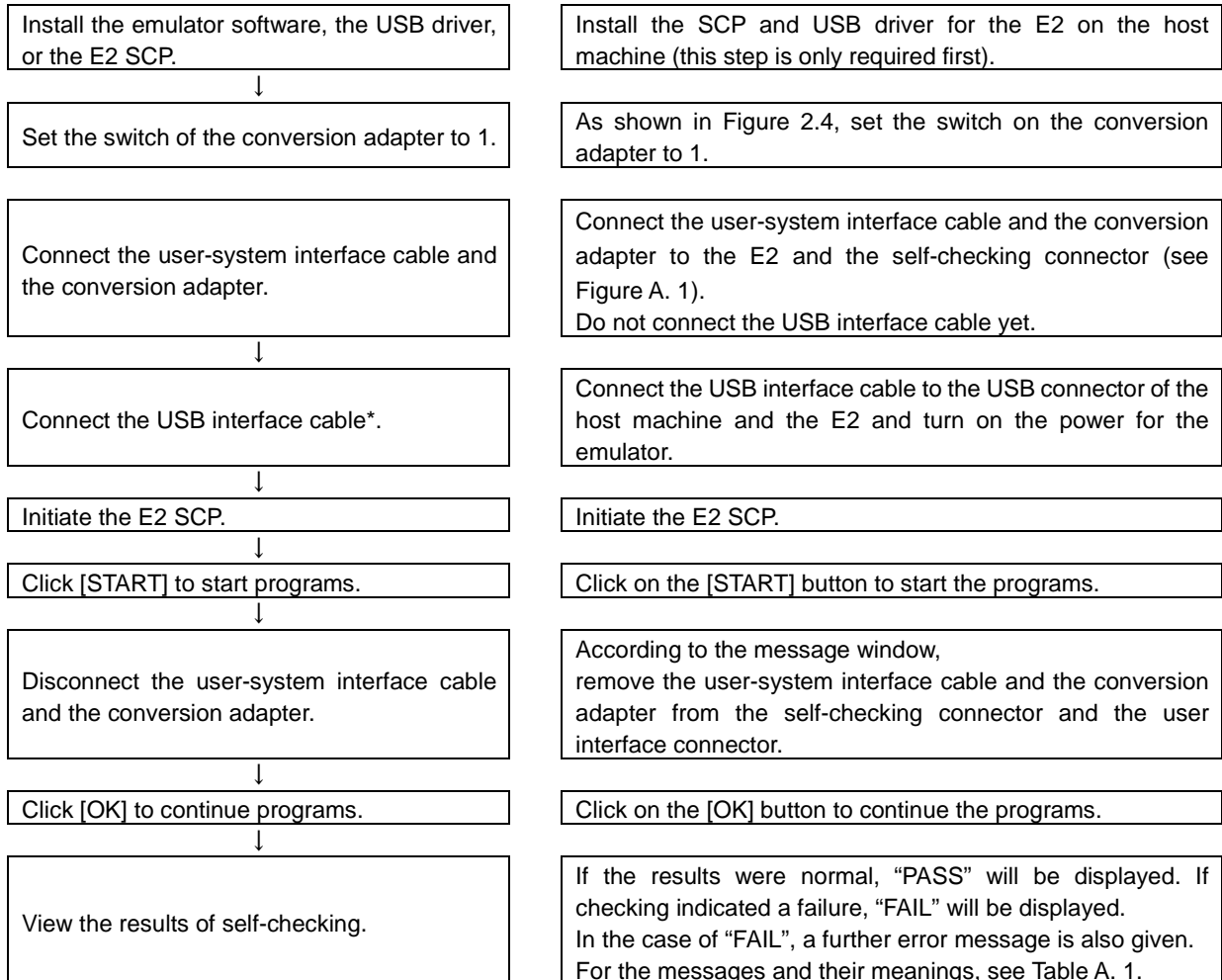

Note: Fault analysis of the hardware by using the E2 SCP only works correctly when a single emulator is connected to the host machine. When two or more emulators are connected, correct operation is not guaranteed.

A.2 Preparations for Self-Checking

- (1) The following items are required to execute the E2 SCP.
 - E2 emulator
 - USB interface cable (included in the package)
 - User-system interface cable (included in the package)
 - 20-pin (1.27-mm pitch) to 14-pin (2.54-mm pitch) connector conversion adapter (included in the package)
Set the switch on the conversion adapter to 1.
 - Host machine
 - E2 SCP (self-checking program)
 Install the E2 SCP to the host machine by installing an integrated development environment from Renesas (e.g. CS+) or downloading the E2 SCP installer from the following Web site.
<https://www.renesas.com/e2-download>

The USB driver is included in the installation of the integrated development environment from Renesas (e.g. CS+ or the e2 studio). If you are using an integrated development environment not from Renesas, please contact a Renesas Electronics representative or distributor.

- (2) Open the lid of the self-checking connector on the E2. Then connect one end of the user-system interface cable to the user-side connector and the other end to the self-checking connector via the conversion adapter.

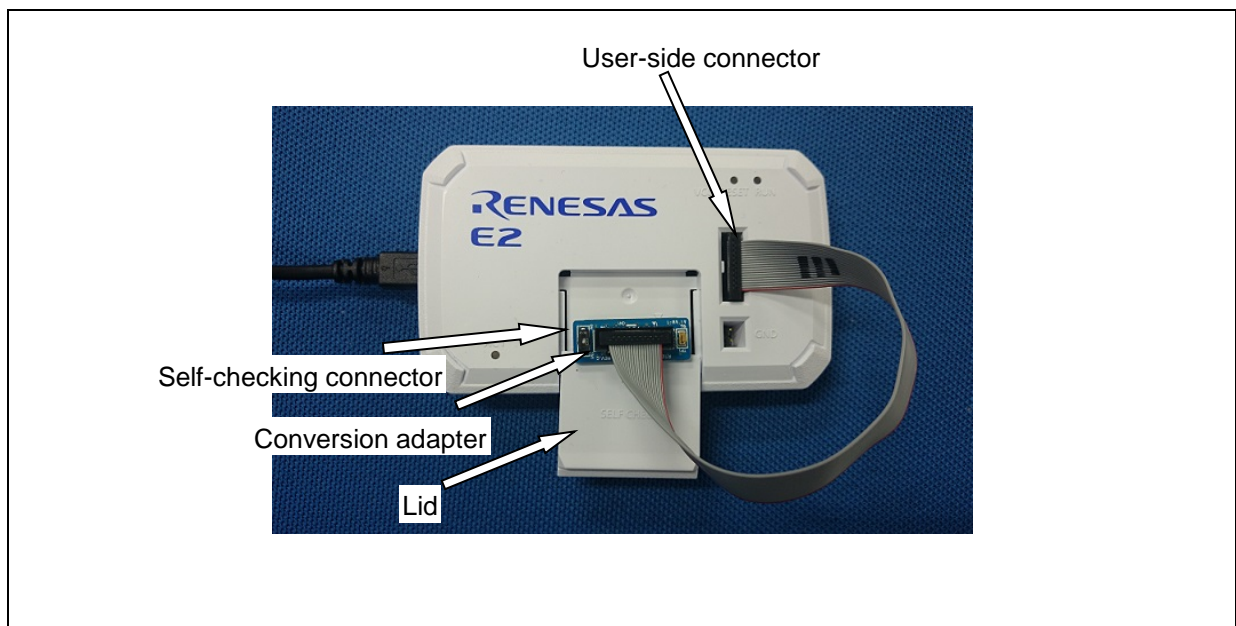

Figure A.1 Connecting the User-System Interface Cable during Executing the E2 SCP

⚠ CAUTION	
!	Insert the conversion adapter firmly into the self-checking connector. If the connection is loose, the result will be "FAIL".

- (3) Start up the host machine. Connect the USB interface cable to the USB connector of the host machine and the E2 and turn on the power for the E2.

A.3 Executing the SCP

- (1) Execute the E2 SCP (E2_SCP.exe).

When CS+ has been installed, open the start menu and select [Programs] -> [Renesas Electronics CS+] -> [E2 Self Check Program].

If you are using any other debugger product, install the SCP by using the installer of the SCP that has been downloaded from the E2 downloading site, then open the start menu and select [Programs] -> [Renesas Electronics Utilities] -> [E2 Self Check Program].

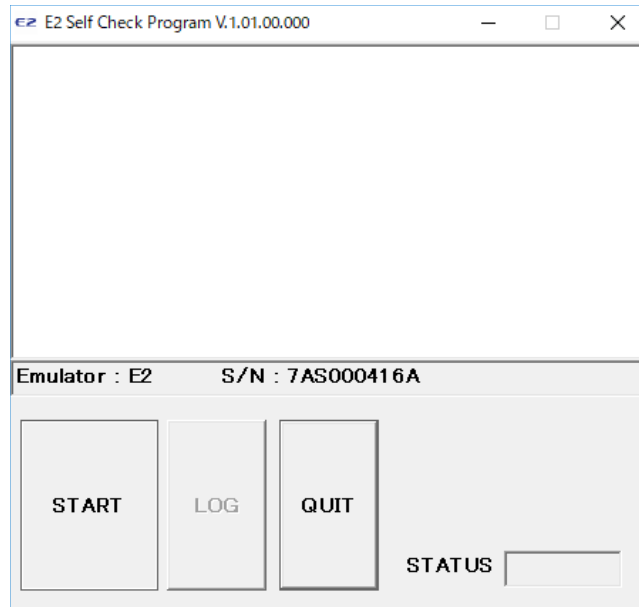

Figure A.2 Starting the E2 SCP

- (2) Click on the [START] button to start the SCP.

If the user-system interface cable and the conversion adapter have not been connected to the self-checking connector, the following message is displayed:

“Please connect the user interface cable and the conversion adapter to the self-check connector on E2 correctly. Please set the switch to the silk printing of "1" on the conversion adapter.”

Check that the user-system interface cable and the conversion adapter are connected to the self-checking connector in the right direction as shown in Figure A.1, and click on the [OK] button. This starts the SCP.

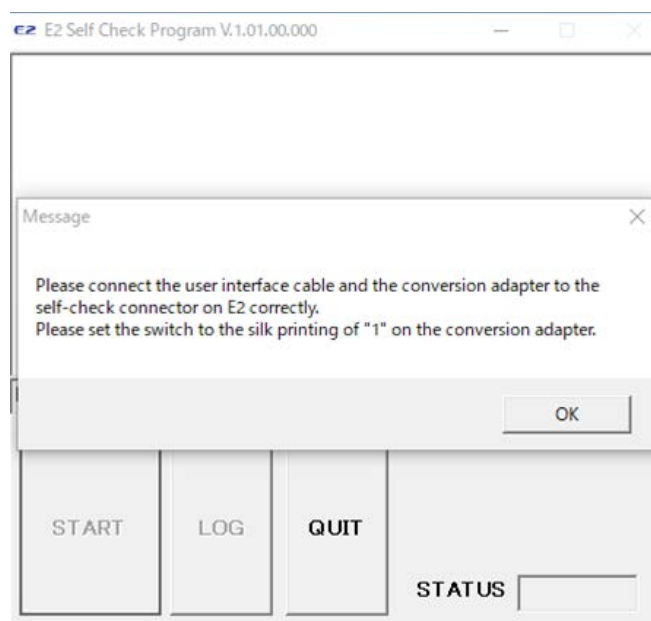

Figure A.3 Checking the Connection

If the user-system interface cable and the conversion adapter have not been connected to the self-checking connector when the [OK] button is clicked on, "FAIL" is displayed on the screen (see figure below). Correctly connect the cable and the adapter to the self-checking connector and click on the [START] button again to start the SCP.

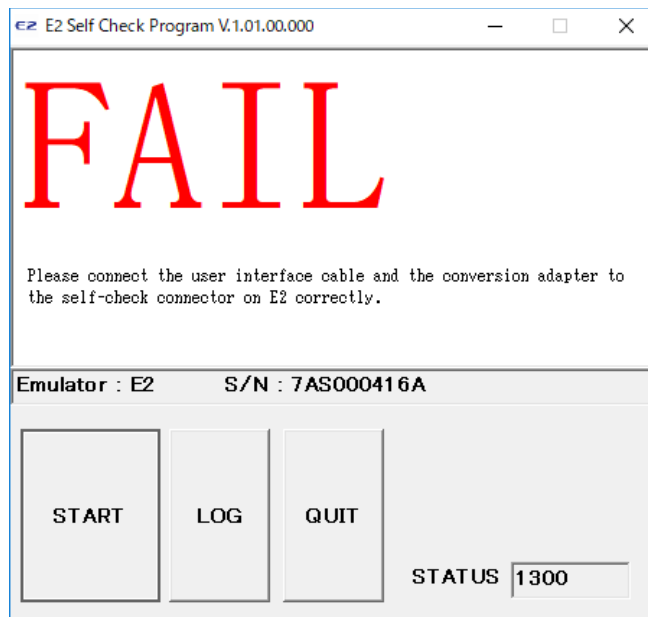

Figure A.4 [FAIL] at the Start of Self-Checking (without the Cable and the Adapter Connected to the Self-Checking Connector)

- (3) The SCP is started.
If the emulator correctly completes TEST00, TEST11, and TEST12, “TEST00: PASS”, “TEST11: PASS”, and “TEST12: PASS” are displayed on the screen.
- (4) When the next test is started, the following message appears.
“Please remove the user interface cable and the conversion adapter from the self-check connector and the user interface connector.”
After this message has been displayed, disconnect the user-system interface cable and the conversion adapter from the self-checking connector and close the lid of the self-checking connector. Then click on the [OK] button to continue with the self-checking process.
If the user-system interface cable and the conversion adapter are still connected to the self-checking connector or user system, clicking on the [OK] button does not restart the self-checking process.

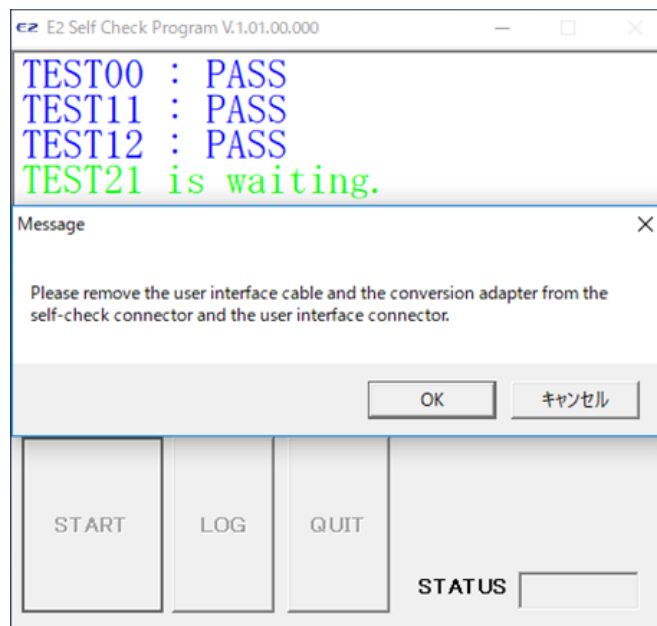

Figure A.5 Message [Please remove the user interface cable and the conversion adapter from the self-check connector and the user interface connector]

If you click on the [Cancel] button in the message window, “FAIL” is displayed on the screen (see figure below). Correctly connect the user-system interface cable and the conversion adapter to the self-checking connector and click on the [START] button again to start the SCP.

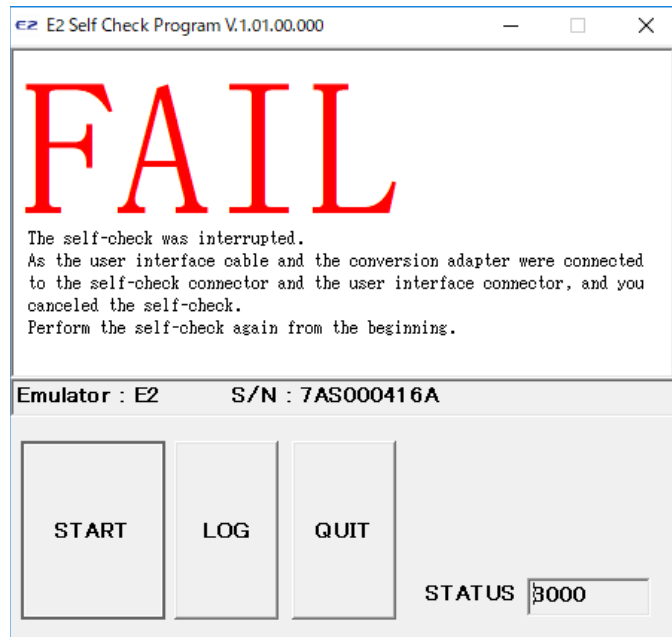

Figure A.6 [FAIL] Display that Appears when [Cancel] in the Message Window is Clicked on

- (5) The SCP is started.
“PASS” or “FAIL” appears on the screen after TEST21, TEST22, TEST23, TEST31, and TEST41 are correctly completed.
“PASS” indicates no problems with the emulator.
Click on the [QUIT] button to end the SCP.

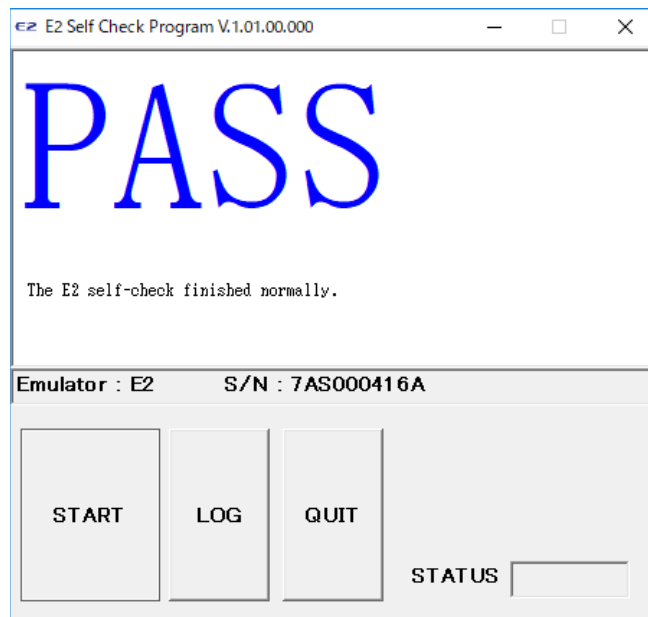

Figure A.7 Normal Completion of SCP

In the case of failure, the word “FAIL” is displayed, followed by an error message in the center of the window. Table A. 1 lists the error messages.

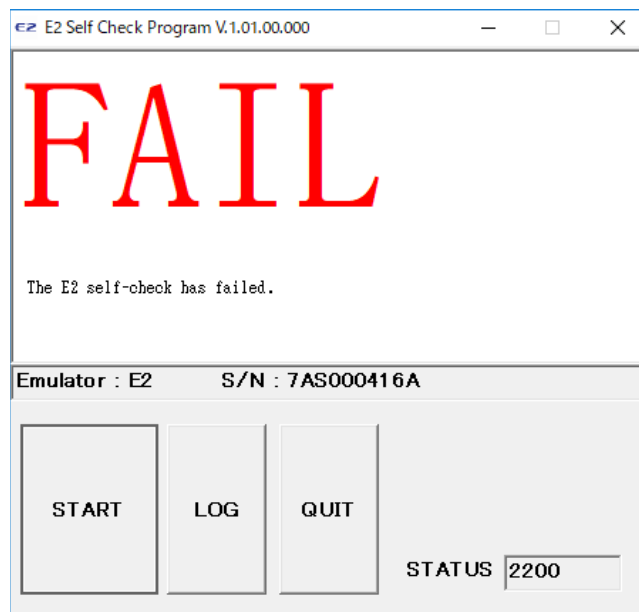

Figure A.8 Display for an Error Found in Self-Checking

Clicking on the [LOG] button opens the file selection dialog box. Specify the location where you want the results of self-checking to be saved. The results of self-checking are saved as a text file.

Table A. 1 Error Messages

Message	Description
The E2 self-check has failed.	There is a fault in the E2. If the fault falls under the warranty conditions given in section 4, Maintenance and Warranty, we will correct the fault or replace the product for free. Correction or replacement in other cases incurs a fee.
Please connect the user interface cable and the conversion adapter to the self-check connector on E2 correctly. Please set the switch to the silk printing of "1" on the conversion adapter.	Correctly connect the user-system interface cable and the conversion adapter to the self-checking connector before starting the SCP.
The self-check was interrupted. As the user interface cable and the conversion adapter were connected to the self-check connector and the user interface connector, and you canceled the self-check. Perform the self-check again from the beginning.	Execution of the SCP was suspended because the [Cancel] button in the message window has been clicked on during self-checking. Restart the SCP from the beginning.

If FAIL is displayed in the other error, please request the repair because the product is defective.

B E2 Expansion Interface

The E2 emulator has extended functions for more efficient debugging. These supplement the on-chip debugging emulators from Renesas in their plain forms. Some of the extended functions require the use of a self-check connector for connection with other equipment through an expansion interface. For details of the functions, refer to the additional documents for user's manual for the E1/E20 emulator, E2 emulator Lite, or E2 emulator, and to application notes.

B.1 Pin Alignment on the Connector

Figure B. 1 and Table B. 1 show the pin alignment of the self-checking connector (E2 expansion interface).

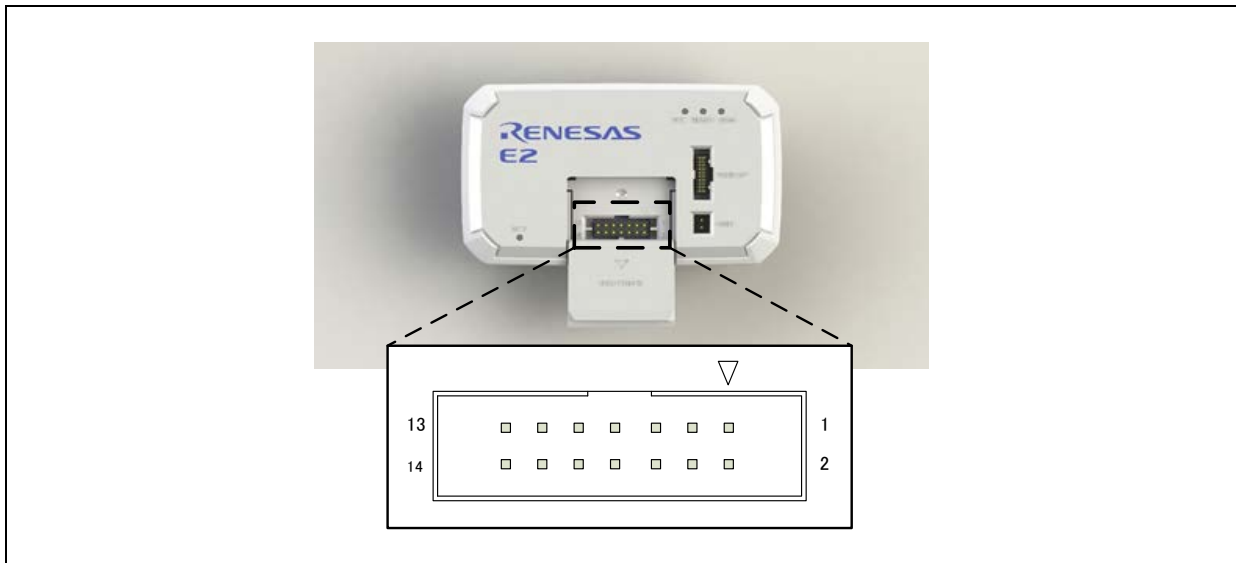

Figure B.1 Pin Alignment of the Self-check Connector (E2 Expansion Interface)

Table B. 1 Pin Functions of the Self-check Connector (E2 Expansion Interface)

Pin No.	Input/Output	Description	Note
1	I/O	Input/output pins for the E2 expansion interface	*1 and *2
2	I/O		
3	I/O		
4	I/O		
5	I/O		
6	I/O		
7	I/O		
8	I/O		
9	I/O		
10	I/O		
11	I/O		
12	I/O		
13	-	GND	-
14	O	Power voltage output pin of the E2 expansion interface (1.8 V to 5.0 V)	Supplied from the user system or the emulator (*1)

*1: For details of the functions, refer to the additional documents for user's manual for the E1/E20 emulator, E2 emulator Lite, or E2 emulator, and to application notes.

*2: For the electrical characteristics of each pin, refer to Figure B. 2 and the data sheet of the product to be used.

B.2 Internal Circuit of the Emulator

Following are the internal circuits of the E2 expansion interface. Please refer to the figure when determining parameters for connection.

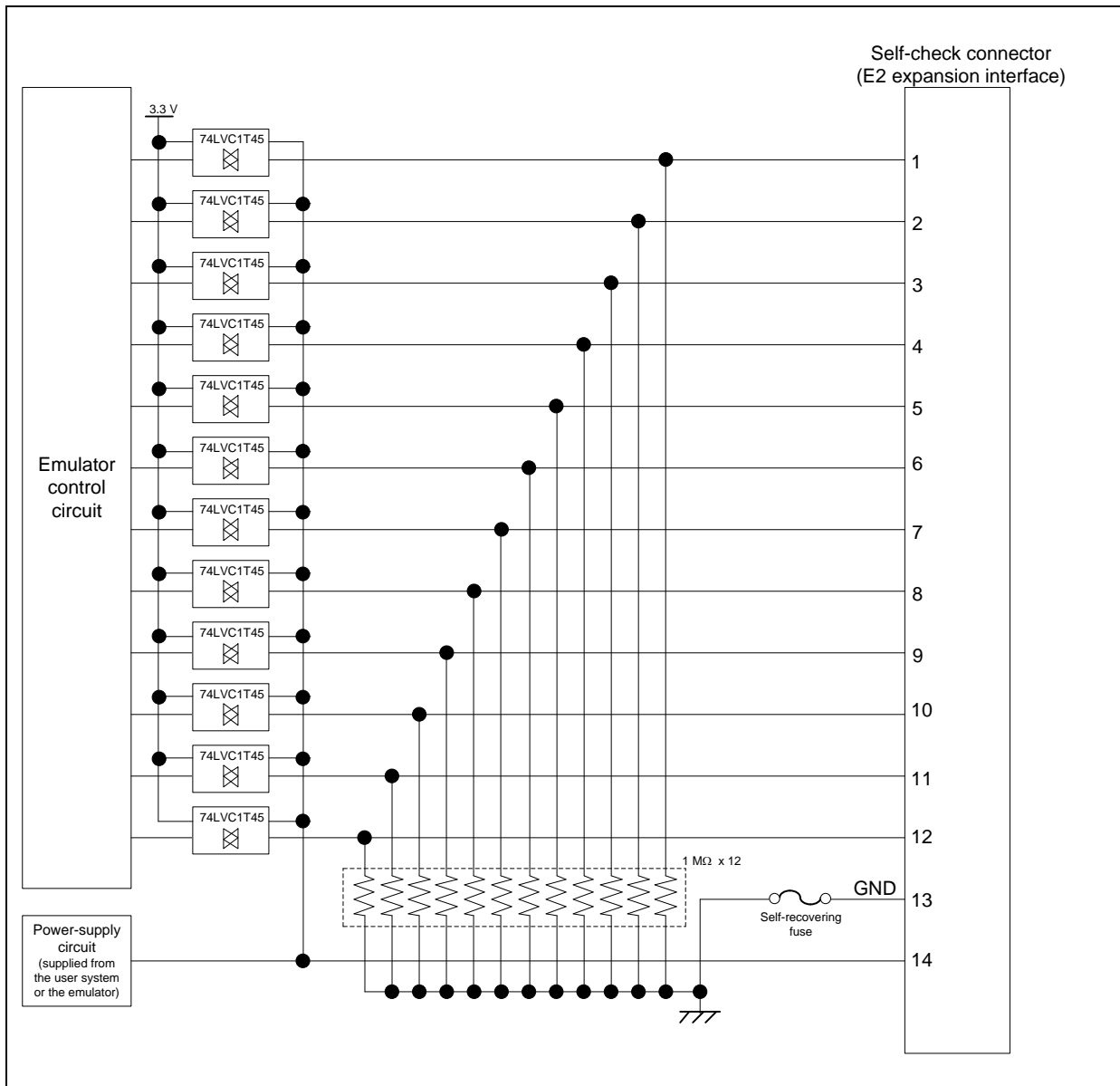

Figure B.2 Internal Circuits of the E2 Expansion Interface

Revision History	E2 Emulator RTE0T00020KCE00000R User's Manual
-------------------------	--

Rev.	Date	Description	
		Page	Summary
1.00	Dec. 01, 2016	—	First Edition issued
2.00	Jul. 01, 2017	3	Added a description of the document configuration
		14,15	Added a description of the E2 expansion interface and updated the description of EMC standards
		17	Added a description of the E2 expansion interface and hot plug-in
		23,24	Added a description of the method of connection for hot plug-in
		19,30, 32	Corrected a URL
		30	Updated the expiration of the repair period
		39,40	Added a description of the E2 expansion interface
3.00	Mar. 01, 2018	11	Table 1.1: Added type names of the user-system interface cable and conversion adapter, along with their descriptions
		18	Figure 1.5: Added descriptions of the conversion adapter
		21, 22	Figure 2.4: Changed descriptions of the conversion adapter. Also, as points for caution, corrected dimensions that impose limits on the footprints of mounted components and added a note on connecting and disconnecting the user-system interface cable and conversion adapter
		33-38	Figures A.2 to A.8: Corrected

E2 Emulator RTE0T00020KCE00000R
User's Manual

Publication Date: Dec 01, 2016 Rev.1.00
 Jul 01, 2017 Rev.2.00
 Mar 01, 2018 Rev.3.00

Published by: Renesas Electronics Corporation

**SALES OFFICES****Renesas Electronics Corporation**<http://www.renesas.com>Refer to "<http://www.renesas.com/>" for the latest and detailed information.**Renesas Electronics America Inc.**1001 Murphy Ranch Road, Milpitas, CA 95035, U.S.A.
Tel: +1-408-432-8888, Fax: +1-408-434-5351**Renesas Electronics Canada Limited**9251 Yonge Street, Suite 8309 Richmond Hill, Ontario Canada L4C 9T3
Tel: +1-905-237-2004**Renesas Electronics Europe Limited**Dukes Meadow, Millboard Road, Bourne End, Buckinghamshire, SL8 5FH, U.K
Tel: +44-1628-651-700, Fax: +44-1628-651-804**Renesas Electronics Europe GmbH**Arcadiastrasse 10, 40472 Düsseldorf, Germany
Tel: +49-211-6503-0, Fax: +49-211-6503-1327**Renesas Electronics (China) Co., Ltd.**Room 1709 Quantum Plaza, No.27 ZhichunLu, Haidian District, Beijing, 100191 P. R. China
Tel: +86-10-8235-1155, Fax: +86-10-8235-7679**Renesas Electronics (Shanghai) Co., Ltd.**Unit 301, Tower A, Central Towers, 555 Langao Road, Putuo District, Shanghai, 200333 P. R. China
Tel: +86-21-2226-0888, Fax: +86-21-2226-0999**Renesas Electronics Hong Kong Limited**Unit 1601-1611, 16/F., Tower 2, Grand Century Place, 193 Prince Edward Road West, Mongkok, Kowloon, Hong Kong
Tel: +852-2265-6688, Fax: +852 2886-9022**Renesas Electronics Taiwan Co., Ltd.**13F, No. 363, Fu Shing North Road, Taipei 10543, Taiwan
Tel: +886-2-8175-9600, Fax: +886 2-8175-9670**Renesas Electronics Singapore Pte. Ltd.**80 Bendemeer Road, Unit #06-02 Hyflux Innovation Centre, Singapore 339949
Tel: +65-6213-0200, Fax: +65-6213-0300**Renesas Electronics Malaysia Sdn.Bhd.**Unit 1207, Block B, Menara Amcorp, Amcorp Trade Centre, No. 18, Jln Persiaran Barat, 46050 Petaling Jaya, Selangor Darul Ehsan, Malaysia
Tel: +60-3-7955-9390, Fax: +60-3-7955-9510**Renesas Electronics India Pvt. Ltd.**No.777C, 100 Feet Road, HAL 2nd Stage, Indiranagar, Bangalore 560 038, India
Tel: +91-80-67208700, Fax: +91-80-67208777**Renesas Electronics Korea Co., Ltd.**17F, KAMCO Yangjae Tower, 262, Gangnam-daero, Gangnam-gu, Seoul, 06265 Korea
Tel: +82-2-558-3737, Fax: +82-2-558-5338

E2 Emulator
RTE0T00020KCE00000R
User's Manual