

Quick Start Guide Renesas Starter Kit for RX72T

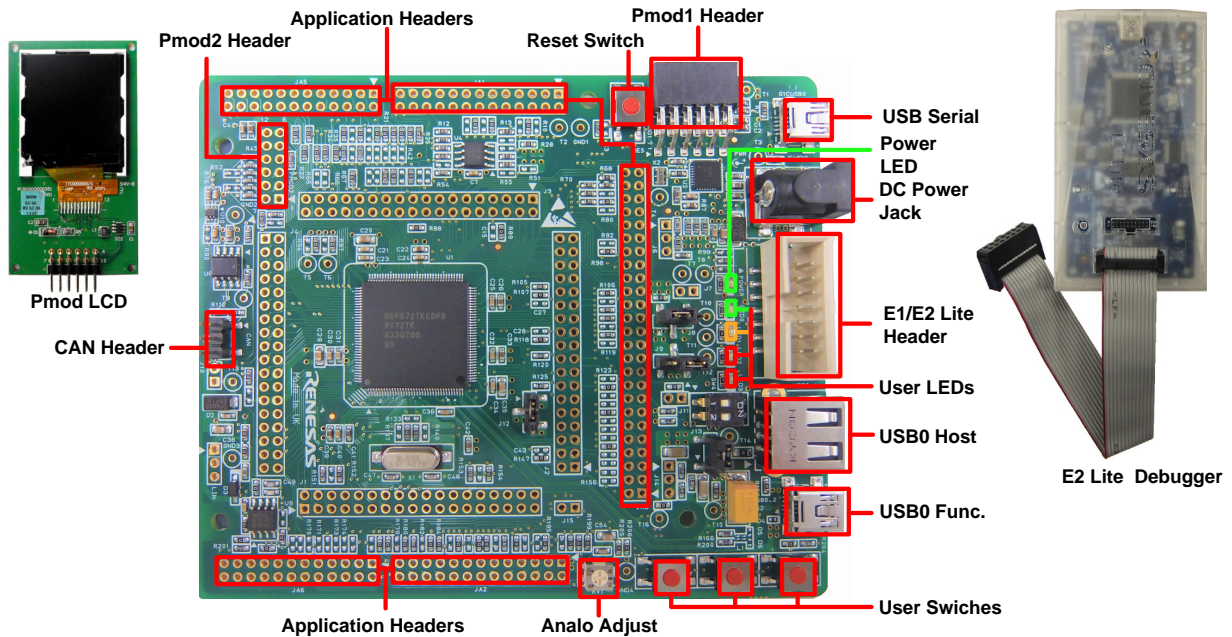

NOTE: This Quick Start Guide covers installation of the e² studio IDE. An active internet connection is required for downloading the RSKRX72T installer.

1. Installation

Do not connect the E2 Lite debugger module until the software support has been installed.

Internet access is required during the installation process.

1. Software for this Renesas Starter Kit is available for download from;

<https://www.renesas.com/rskrx72t/install/e2>

2. After download the installer will run and display the Welcome dialog. Follow the on-screen instructions to install the RSK software. This process will take several minutes.

Note:

Windows™ 10 / 8.1 / 8 / 7 users may see "User Account Control" dialog box. If applicable, enter the administrator password and click 'Yes'.

The Windows™ driver signing dialog box may be displayed. Please accept the driver to continue.

Users may see a Renesas trust certificate dialog box. If applicable select the checkbox to trust the certificate.

2. Connection

3. Ensure the PMOD LCD is fitted to the connector marked 'PMOD1' on the RSK.
4. Connect the E2 Lite debugger module to the connector marked 'E1/E2 Lite' on the RSK using the ribbon cable.
5. Connect the E2 Lite debugger module to a spare USB port of your PC. The green 'ACT' LED on the E2 Lite debugger will flash.
6. The E2 Lite debugger drivers will now be installed. Note that, this may take up to a minute and administrator privileges will be required.

Windows™ 7

"Device driver software installed successfully" pop-up will appear in the Windows™ Taskbar and installation will complete.

Windows™ 8.1 / 8

An icon will appear in the Windows™ Taskbar and installation will complete.

Windows™ 10

A Windows™ taskbar buttons of "Device Setup" will appear in the Windows™ Taskbar and installation will complete.

3. Importing Sample Code into e² studio

e² studio integrates various tools such as compiler, assembler, debugger and editor into a common graphical user interface.

7. Start e² studio:



Windows™ 7: Start Menu > All Programs > Renesas Electronics e2studio > e2 studio

Windows™ 8.1 & 8: From Apps View , Renesas Electronics e2studio > e2 studio

Windows™ 10: Start Menu > All Apps > Renesas Electronics e2studio > e2 studio

8. In the 'Select a workspace' folder that appears, browse a suitable location and folder name to save your new workspace to. Click 'Launch' to continue.
9. In the 'Toolchain Integration' dialog select Renesas Toolchains and ensure that 'Renesas CCRX - v3.01.00' is selected. Click 'Register'. A dialog will appear "Selected Toolchains were successfully integrated with e2 studio". Click 'OK'.
10. In the 'Code Generator Registration' dialog click 'OK'.
11. A 'Code Generator COM component register' dialog will pop-up with the text "Please restart e2 studio to use Code Generator". Click 'OK'.
12. In the 'Restart e2 studio' dialog click 'OK'. e² studio will be restarted due to first-time registration of the Code Generator COM component.
13. Once e² studio is restarted the 'Select a workspace' window appears again. Click 'OK'.
14. In the e² studio welcome screen, click the 'Workbench' arrow icon, on the far right. 
15. Right click in the Project Explorer window, and select 'Import'.
16. In the Select an import wizard, select General > Existing Projects into Workspace, and click 'Next'.
17. Click the 'Browse' button, and locate the following directory 'C:\Renesas\Workspace\RSK\RSKRX72T'.
18. Ensure the 'Copy projects into workspace' option is ticked, then click 'Finish'.
19. During the import process an information dialog may report 'Toolchain path has been modified for the project...', Click 'OK'.

4. Programming and Debug

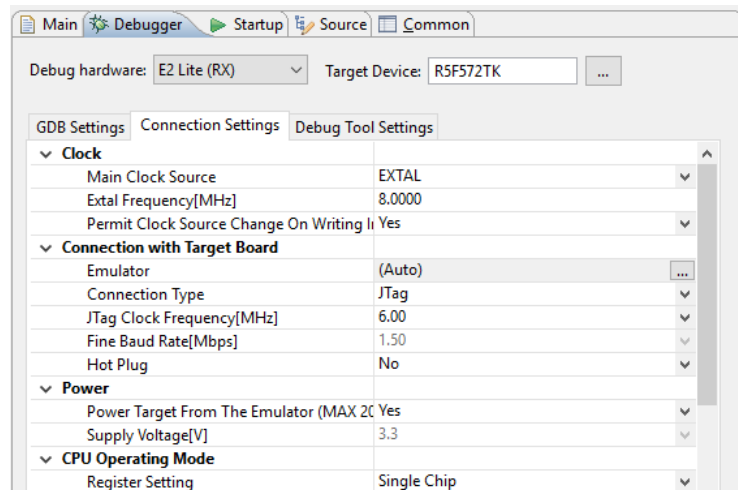

20. Select the "Tutorial" project by left clicking on it, then click the arrow next to build button (hammer icon), and select 'HardwareDebug' from the drop down menu. 
21. e² studio will now build the project. Once this is complete, debugging can be started by clicking the arrow next to debug button (bug icon), and selecting 'Debug Configurations'. 
22. Click the symbol next to the entry 'Renesas GDB Hardware Debugging' to expand the list and click on 'Tutorial HardwareDebug'.
23. Click the 'Debugger' tab, then the 'Connection Settings' secondary tab. Review the settings listed in the screenshot below.



Note:

Sample projects supplied with this RSK can supply power from the E2 Lite debugger. It is not necessary to supply external power to the board.

Please use external power supply when operating at 5V or when the power supply is insufficient in customer's application. In this case, please set 'Power Target From The Emulator (MAX 200mA)' on 'Connection Settings' secondary tab to 'No'.

24. Click the 'Debug' button to download the code to the target, and begin debugging.
25. A firewall warning may be displayed for 'e2-server-gdb.exe'. Select the check-box for 'Private networks, such as my home or work network', and click 'Allow access'.
26. A User Account Control (UAC) dialog may be displayed. Enter the administrator password and click 'Yes'.
27. e² studio may ask you to change to the 'Renesas Debug Perspective', click 'Yes'.
28. The green 'ACT' LED on the E2 Lite debugger will illuminate constantly.
29. Once the code has been downloaded, click the 'Resume' button to run the code up to the first line of the main function, R_SWITCH_Init(). 
Click 'Resume' again to run the target through the rest of the code.
30. Press any switch (SW1, SW2 or SW3). An A/D conversion will be performed and the result will be displayed on the LCD panel.
31. Rotate the Potentiometer Control and press any switch again. A new A/D conversion will be performed and the count of A/D conversions will be displayed in binary form using LEDs 0-3. 

32. Click the 'Suspend' button. The program will stop and the source code will be opened at the current program counter.



33. To disconnect from the target board, click the 'Disconnect' button on the toolbar.

34. Select the C/C++ perspective (at the top right) to return to the editor view.

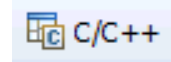

5. Next Step

After you have completed this quick start procedure, please review the tutorial and sample code that came with the kit. The tutorial project will help you understand the device and development process using Renesas Development Tools.

Please refer to "description.txt" in each sample project for sample code specification and operating procedure.

The content of the manuals included in the installer are at the time of publication. Please check for any updates to the manual from the Renesas internet site at: <https://www.renesas.com/rskrx72t>

To learn more on how to use e² studio, open the program's help files by using Help > Help Contents.

6. Renesas RX Compiler

The version of the compiler provided with this RSK is fully functional for 60 days and then code size limited to 128Kbytes of Code and Data. This restriction can be removed by purchasing a licenced copy of the tools.

7. User Manuals

The user manuals for this product can be found at the following locations:

Windows™7:

Start Menu > All Programs > Renesas Electronics Tools > RSKRX72T e2 studio > Manuals

Windows™8.1 & 8:

From the Apps View , all the manuals are located in "Renesas Electronics Tools".

Windows™10:

Start Menu > Apps > Renesas Electronics Tools

RX72T Group User's Manuals: Hardware (R01UH0803EJ) is available at: <https://www.renesas.com/rskrx72t>

8. Support

Online technical support and information is available at: <https://www.renesas.com/rskrx72t>

Technical Contact Details

America: techsupport.america@renesas.com

Europe: <https://www.renesas.com/eu/en/support/contact.html>

Global & Japan: <https://www.renesas.com/support/contact.html>

© 2018 Renesas Electronics Europe Limited. All rights reserved

© 2018 Renesas Electronics Corporation. All rights reserved.

Website: <https://www.renesas.com/>

D016174_11_S01_V01

R20UT4277EG0100

Nov 30, 2018