

To our customers,

Old Company Name in Catalogs and Other Documents

On April 1st, 2010, NEC Electronics Corporation merged with Renesas Technology Corporation, and Renesas Electronics Corporation took over all the business of both companies. Therefore, although the old company name remains in this document, it is a valid Renesas Electronics document. We appreciate your understanding.

Renesas Electronics website: <http://www.renesas.com>

April 1st, 2010
Renesas Electronics Corporation

Issued by: Renesas Electronics Corporation (<http://www.renesas.com>)

Send any inquiries to <http://www.renesas.com/inquiry>.

Notice

1. All information included in this document is current as of the date this document is issued. Such information, however, is subject to change without any prior notice. Before purchasing or using any Renesas Electronics products listed herein, please confirm the latest product information with a Renesas Electronics sales office. Also, please pay regular and careful attention to additional and different information to be disclosed by Renesas Electronics such as that disclosed through our website.
2. Renesas Electronics does not assume any liability for infringement of patents, copyrights, or other intellectual property rights of third parties by or arising from the use of Renesas Electronics products or technical information described in this document. No license, express, implied or otherwise, is granted hereby under any patents, copyrights or other intellectual property rights of Renesas Electronics or others.
3. You should not alter, modify, copy, or otherwise misappropriate any Renesas Electronics product, whether in whole or in part.
4. Descriptions of circuits, software and other related information in this document are provided only to illustrate the operation of semiconductor products and application examples. You are fully responsible for the incorporation of these circuits, software, and information in the design of your equipment. Renesas Electronics assumes no responsibility for any losses incurred by you or third parties arising from the use of these circuits, software, or information.
5. When exporting the products or technology described in this document, you should comply with the applicable export control laws and regulations and follow the procedures required by such laws and regulations. You should not use Renesas Electronics products or the technology described in this document for any purpose relating to military applications or use by the military, including but not limited to the development of weapons of mass destruction. Renesas Electronics products and technology may not be used for or incorporated into any products or systems whose manufacture, use, or sale is prohibited under any applicable domestic or foreign laws or regulations.
6. Renesas Electronics has used reasonable care in preparing the information included in this document, but Renesas Electronics does not warrant that such information is error free. Renesas Electronics assumes no liability whatsoever for any damages incurred by you resulting from errors in or omissions from the information included herein.
7. Renesas Electronics products are classified according to the following three quality grades: “Standard”, “High Quality”, and “Specific”. The recommended applications for each Renesas Electronics product depends on the product’s quality grade, as indicated below. You must check the quality grade of each Renesas Electronics product before using it in a particular application. You may not use any Renesas Electronics product for any application categorized as “Specific” without the prior written consent of Renesas Electronics. Further, you may not use any Renesas Electronics product for any application for which it is not intended without the prior written consent of Renesas Electronics. Renesas Electronics shall not be in any way liable for any damages or losses incurred by you or third parties arising from the use of any Renesas Electronics product for an application categorized as “Specific” or for which the product is not intended where you have failed to obtain the prior written consent of Renesas Electronics. The quality grade of each Renesas Electronics product is “Standard” unless otherwise expressly specified in a Renesas Electronics data sheets or data books, etc.
 - “Standard”: Computers; office equipment; communications equipment; test and measurement equipment; audio and visual equipment; home electronic appliances; machine tools; personal electronic equipment; and industrial robots.
 - “High Quality”: Transportation equipment (automobiles, trains, ships, etc.); traffic control systems; anti-disaster systems; anti-crime systems; safety equipment; and medical equipment not specifically designed for life support.
 - “Specific”: Aircraft; aerospace equipment; submersible repeaters; nuclear reactor control systems; medical equipment or systems for life support (e.g. artificial life support devices or systems), surgical implantations, or healthcare intervention (e.g. excision, etc.), and any other applications or purposes that pose a direct threat to human life.
8. You should use the Renesas Electronics products described in this document within the range specified by Renesas Electronics, especially with respect to the maximum rating, operating supply voltage range, movement power voltage range, heat radiation characteristics, installation and other product characteristics. Renesas Electronics shall have no liability for malfunctions or damages arising out of the use of Renesas Electronics products beyond such specified ranges.
9. Although Renesas Electronics endeavors to improve the quality and reliability of its products, semiconductor products have specific characteristics such as the occurrence of failure at a certain rate and malfunctions under certain use conditions. Further, Renesas Electronics products are not subject to radiation resistance design. Please be sure to implement safety measures to guard them against the possibility of physical injury, and injury or damage caused by fire in the event of the failure of a Renesas Electronics product, such as safety design for hardware and software including but not limited to redundancy, fire control and malfunction prevention, appropriate treatment for aging degradation or any other appropriate measures. Because the evaluation of microcomputer software alone is very difficult, please evaluate the safety of the final products or system manufactured by you.
10. Please contact a Renesas Electronics sales office for details as to environmental matters such as the environmental compatibility of each Renesas Electronics product. Please use Renesas Electronics products in compliance with all applicable laws and regulations that regulate the inclusion or use of controlled substances, including without limitation, the EU RoHS Directive. Renesas Electronics assumes no liability for damages or losses occurring as a result of your noncompliance with applicable laws and regulations.
11. This document may not be reproduced or duplicated, in any form, in whole or in part, without prior written consent of Renesas Electronics.
12. Please contact a Renesas Electronics sales office if you have any questions regarding the information contained in this document or Renesas Electronics products, or if you have any other inquiries.

(Note 1) “Renesas Electronics” as used in this document means Renesas Electronics Corporation and also includes its majority-owned subsidiaries.

(Note 2) “Renesas Electronics product(s)” means any product developed or manufactured by or for Renesas Electronics.

M32R-FPU

Software Manual

RENESAS 32-BIT RISC SINGLE-CHIP
MICROCOMPUTER

All information contained in these materials, including products and product specifications, represents information on the product at the time of publication and is subject to change by Renesas Electronics Corp. without notice. Please review the latest information published by Renesas Electronics Corp. through various means, including the Renesas Electronics Corp. website (<http://www.renesas.com>).

Keep safety first in your circuit designs!

- Renesas Technology Corporation puts the maximum effort into making semiconductor products better and more reliable, but there is always the possibility that trouble may occur with them. Trouble with semiconductors may lead to personal injury, fire or property damage. Remember to give due consideration to safety when making your circuit designs, with appropriate measures such as (i) placement of substitutive, auxiliary circuits, (ii) use of non-flammable material or (iii) prevention against any malfunction or mishap.

Notes regarding these materials

- These materials are intended as a reference to assist our customers in the selection of the Renesas Technology Corporation product best suited to the customer's application; they do not convey any license under any intellectual property rights, or any other rights, belonging to Renesas Technology Corporation or a third party.
- Renesas Technology Corporation assumes no responsibility for any damage, or infringement of any third-party's rights, originating in the use of any product data, diagrams, charts, programs, algorithms, or circuit application examples contained in these materials.
- All information contained in these materials, including product data, diagrams, charts, programs and algorithms represents information on products at the time of publication of these materials, and are subject to change by Renesas Technology Corporation without notice due to product improvements or other reasons. It is therefore recommended that customers contact Renesas Technology Corporation or an authorized Renesas Technology Corporation product distributor for the latest product information before purchasing a product listed herein.

The information described here may contain technical inaccuracies or typographical errors. Renesas Technology Corporation assumes no responsibility for any damage, liability, or other loss rising from these inaccuracies or errors.

Please also pay attention to information published by Renesas Technology Corporation by various means, including the Renesas Technology Corporation Semiconductor home page (<http://www.renesas.com>).

- When using any or all of the information contained in these materials, including product data, diagrams, charts, programs, and algorithms, please be sure to evaluate all information as a total system before making a final decision on the applicability of the information and products. Renesas Technology Corporation assumes no responsibility for any damage, liability or other loss resulting from the information contained herein.
- Renesas Technology Corporation semiconductors are not designed or manufactured for use in a device or system that is used under circumstances in which human life is potentially at stake. Please contact Renesas Technology Corporation or an authorized Renesas Technology Corporation product distributor when considering the use of a product contained herein for any specific purposes, such as apparatus or systems for transportation, vehicular, medical, aerospace, nuclear, or undersea repeater use.
- The prior written approval of Renesas Technology Corporation is necessary to reprint or reproduce in whole or in part these materials.
- If these products or technologies are subject to the Japanese export control restrictions, they must be exported under a license from the Japanese government and cannot be imported into a country other than the approved destination.
Any diversion or reexport contrary to the export control laws and regulations of Japan and/or the country of destination is prohibited.
- Please contact Renesas Technology Corporation for further details on these materials or the products contained therein.

REVISION HISTORY

M32R-FPU Software Manual

Rev.	Date	Description	
		Page	Summary
1.00	Jan 08, 2003	–	First edition issued
1.01	Oct 31, 2003	APPENDICES-3	Hexadecimal Instruction Code Table corrected (BTST instruction)
		APPENDICES-8	Appendix Figure 3.1.1 corrected Incorrect) *The E1 stage of the FDIV instruction requires 13 cycles. Correct) *The E1 stage of the FDIV instruction requires 14 cycles.
		APPENDICES-10	Appendix Figure 3.2.1 corrected Incorrect) LD1 Correct) LDI
		APPENDICES-13	Appendix Figure 3.2.4 corrected Incorrect) ADD <i>R1</i> , <i>R6</i> , <i>R7</i> Correct) FMADD <i>R1</i> , <i>R6</i> , <i>R7</i>

Table of contents

CHAPTER 1 CPU PROGRAMMING MODEL

1.1 CPU register	1-2
1.2 General-purpose registers	1-2
1.3 Control registers	1-3
1.3.1 Processor status word register: PSW (CR0)	1-4
1.3.2 Condition bit register: CBR (CR1)	1-5
1.3.3 Interrupt stack pointer: SPI (CR2) User stack pointer: SPU (CR3)	1-5
1.3.4 Backup PC: BPC (CR6)	1-5
1.3.5 Floating-Point Status Register: FPSR (CR7)	1-6
1.3.6 Floating-Point Exceptions (FPE)	1-8
1.4 Accumulator	1-11
1.5 Program counter	1-11
1.6 Data format	1-12
1.6.1 Data type	1-12
1.6.2 Data format	1-13
1.7 Addressing mode	1-15

CHAPTER 2 INSTRUCTION SET

2.1 Instruction set overview	2-2
2.1.1 Load/store instructions	2-2
2.1.2 Transfer instructions	2-4
2.1.3 Operation instructions	2-4
2.1.4 Branch instructions	2-6
2.1.5 EIT-related instructions	2-8
2.1.6 DSP function instructions	2-8
2.1.7 Floating-point Instructions	2-11
2.1.8 Bit Operation Instructions	2-11
2.2 Instruction format	2-12

CHAPTER 3 INSTRUCTIONS

3.1 Conventions for instruction description	3-2
3.2 Instruction description	3-5

APPENDIX

Appendix 1 Hexadecimal Instruction Code	Appendix-2
Appendix 2 Instruction List	Appendix-4
Appendix 3 Pipeline Processing	Appendix-8
Appendix 3.1 Instructions and Pipeline Processing	Appendix-8
Appendix 3.2 Pipeline Basic Operation	Appendix-10
Appendix 4 Instruction Execution Time	Appendix-17
Appendix 5 IEEE754 Specification Overview	Appendix-18
Appendix 5.1 Floating Point Formats	Appendix-18
Appendix 5.2 Rounding	Appendix-20
Appendix 5.3 Exceptions	Appendix-20
Appendix 6 M32R-FPU Specification Supplemental Explanation	Appendix-23
Appendix 6.1 Operation Comparison: Using 1 instruction (FMADD or FMSBU) vs. two instructions (FMUL and FADD)	Appendix-23
Appendix 6.1.1 Rounding Mode	Appendix-23
Appendix 6.1.2 Exception occurring in Step 1	Appendix-23
Appendix 6.2 Rules concerning Generation of QNaN in M32R-FPU	Appendix-28
Appendix 7 Precautions	Appendix-29
Appendix 7.1 Precautions to be taken when aligning data	Appendix-29

INDEX

This page left blank intentionally.

CHAPTER 1

CPU PROGRAMMING MODEL

- 1.1 CPU Register
- 1.2 General-purpose Registers
- 1.3 Control Registers
- 1.4 Accumulator
- 1.5 Program Counter
- 1.6 Data Format
- 1.7 Addressing Mode

1.1 CPU Register

The M32R family CPU, with a built-in FPU (herein referred to as M32R-FPU) has 16 general-purpose registers, 6 control registers, an accumulator and a program counter. The accumulator is of 56-bit configuration, and all other registers are a 32-bit configuration.

1.2 General-purpose Registers

The 16 general-purpose registers (R0 – R15) are of 32-bit width and are used to retain data and base addresses, as well as for integer calculations, floating-point operations, etc. R14 is used as the link register and R15 as the stack pointer. The link register is used to store the return address when executing a subroutine call instruction. The Interrupt Stack Pointer (SPI) and the User Stack Pointer (SPU) are alternately represented by R15 depending on the value of the Stack Mode (SM) bit in the Processor Status Word Register (PSW).

At reset release, the value of the general-purpose registers is undefined.

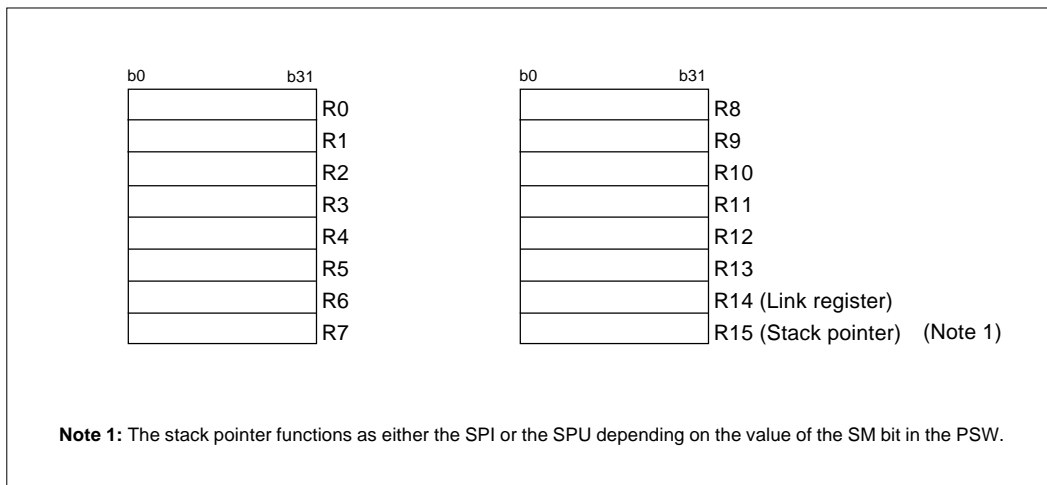

Figure 1.2.1 General-purpose Registers

1.3 Control Registers

There are 6 control registers which are the Processor Status Word Register (PSW), the Condition Bit Register (CBR), the Interrupt Stack Pointer (SPI), the User Stack Pointer (SPU), the Backup PC (BPC) and the Floating-point Status Register (FPSR). The dedicated **MVTC** and **MVFC** instructions are used for writing and reading these control registers.

In addition, the SM bit, IE bit and C bit of the PSW can also be set by the SETPSW instruction or the CLRPSW instruction.

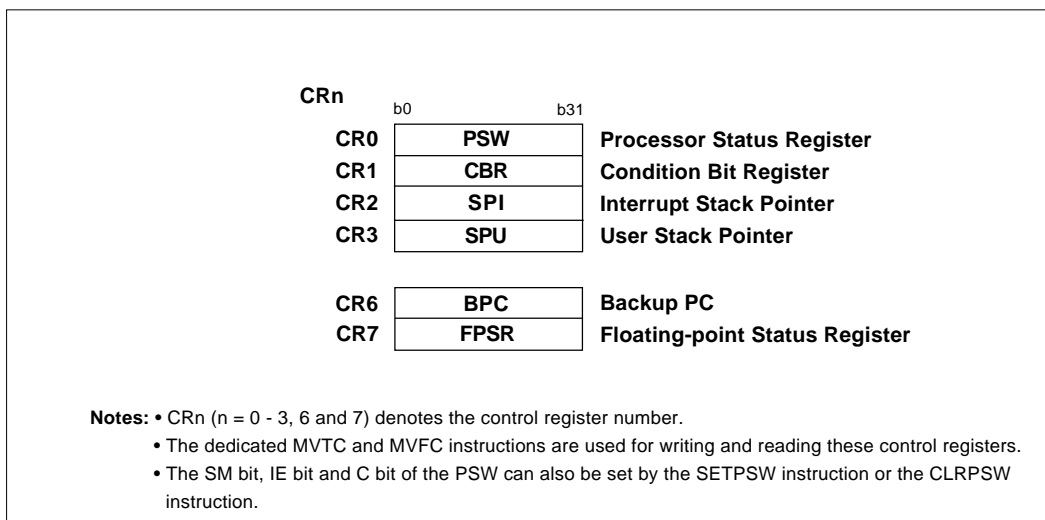
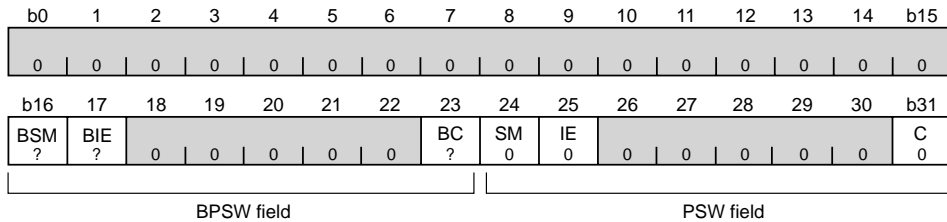

Figure 1.3.1 Control Registers

1.3.1 Processor Status Word Register: PSW (CR0)



< At reset release: "B'0000 0000 0000 0000 ??00 000? 0000 0000 >

b	Bit Name	Function	R	W
0-15	No function assigned. Fix to "0".		0	0
16	BSM Backup SM Bit	Saves value of SM bit when EIT occurs	R	W
17	BIE Backup IE Bit	Saves value of IE bit when EIT occurs	R	W
18-22	No function assigned. Fix to "0".		0	0
23	BC Backup C Bit	Saves value of C bit when EIT occurs	R	W
24	SM Stack Mode Bit	0: Uses R15 as the interrupt stack pointer 1: Uses R15 as the user stack pointer	R	W
25	IE Interrupt Enable Bit	0: Does not accept interrupt 1: Accepts interrupt	R	W
26-30	No function assigned. Fix to "0".		0	0
31	C Condition Bit	Indicates carry, borrow and overflow resulting from operations (instruction dependent)	R	W

The Processor Status Word Register (PSW) indicates the M32R-FPU status. It consists of the current PSW field which is regularly used, and the BPSW field where a copy of the PSW field is saved when EIT occurs.

The PSW field consists of the Stack Mode (SM) bit, the Interrupt Enable (IE) bit and the Condition (C) bit.

The BPSW field consists of the Backup Stack Mode (BSM) bit, the Backup Interrupt Enable (BIE) bit and the Backup Condition (BC) bit.

At reset release, BSM, BIE and BC are undefined. All other bits are "0".

1.3.2 Condition Bit Register: CBR (CR1)

The Condition Bit Register (CBR) is derived from the PSW register by extracting its Condition (C) bit. The value written to the PSW register's C bit is reflected in this register. The register can only be read. (Writing to the register with the **MVTC** instruction is ignored.)

At reset release, the value of CBR is "H'0000 0000".

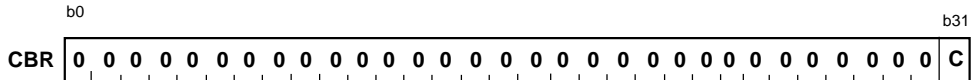

1.3.3 Interrupt Stack Pointer: SPI (CR2)

User Stack Pointer: SPU (CR3)

The Interrupt Stack Pointer (SPI) and the User Stack Pointer (SPU) retain the address of the current stack pointer. These registers can be accessed as the general-purpose register R15. R15 switches between representing the SPI and SPU depending on the value of the Stack Mode (SM) bit in the PSW.

At reset release, the value of the SPI and SPU are undefined.

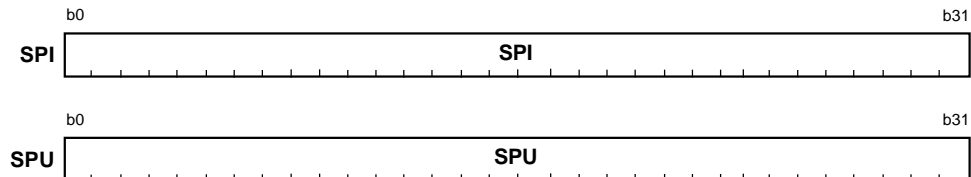

1.3.4 Backup PC: BPC (CR6)

The Backup PC (BPC) is used to save the value of the Program Counter (PC) when an EIT occurs. Bit 31 is fixed to "0".

When an EIT occurs, the register sets either the PC value when the EIT occurred or the PC value for the next instruction depending on the type of EIT. The BPC value is loaded to the PC when the **RTE** instruction is executed. However, the values of the lower 2 bits of the PC are always "00" when returned (PC always returns to the word-aligned address).

At reset release, the value of the BPC is undefined.

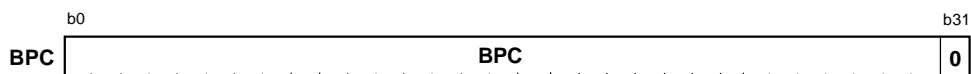

1.3.5 Floating-point Status Register: FPSR (CR7)

b0	1	2	3	4	5	6	7	8	9	10	11	12	13	14	b15
FS 0	FX 0	FU 0	FZ 0	FO 0	FV 0	0	0	0	0	0	0	0	0	0	0
b16	17	18	19	20	21	22	23	24	25	26	27	28	29	30	b31
0	EX 0	EU 0	EZ 0	EO 0	EV 0	0	DN 1	CE 0	CX 0	CU 0	CZ 0	CO 0	CV 0	0	RM 0

<At reset release: H0000 0100>

b	Bit Name	Function	R	W
0	FS Floating-point Exception Summary Bit	Reflects the logical sum of FU, FZ, FO and FV.	R	–
1	FX Inexact Exception Flag	Set to "1" when an inexact exception occurs (if EIT processing is unexecuted (Note 1)). Once set, the flag retains the value "1" until it is cleared to "0" in software.	R	W
2	FU Underflow Exception Flag	Set to "1" when an underflow exception occurs (if EIT processing is unexecuted (Note 1)). Once set, the flag retains the value "1" until it is cleared to "0" in software.	R	W
3	FZ Zero Divide Exception Flag	Set to "1" when a zero divide exception occurs (if EIT processing is unexecuted (Note 1)). Once set, the flag retains the value "1" until it is cleared to "0" in software.	R	W
4	FO Overflow Exception Flag	Set to "1" when an overflow exception occurs (if EIT processing is unexecuted (Note 1)). Once set, the flag retains the value "1" until it is cleared to "0" in software.	R	W
5	FV Invalid Operation Exception Flag	Set to "1" when an invalid operation exception occurs (if EIT processing is unexecuted (Note 1)). Once set, the flag retains the value "1" until it is cleared to "0" in software.	R	W
6–16	No function assigned. Fix to "0".		0	0
17	EX Inexact Exception Enable Bit	0: Mask EIT processing to be executed when an inexact exception occurs 1: Execute EIT processing when an inexact exception occurs	R	W
18	EU Underflow Exception Enable Bit	0: Mask EIT processing to be executed when an underflow exception occurs 1: Execute EIT processing when an underflow exception occurs	R	W
19	EZ Zero Divide Exception Enable Bit	0: Mask EIT processing to be executed when a zero divide exception occurs 1: Execute EIT processing when a zero divide exception occurs	R	W
20	EO Overflow Exception Enable Bit	0: Mask EIT processing to be executed when an overflow exception occurs 1: Execute EIT processing when an overflow exception occurs	R	W

21	EV Invalid Operation Exception Enable Bit	0: Mask EIT processing to be executed when an invalid operation exception occurs 1: Execute EIT processing when an invalid operation exception occurs	R	W
22	No function assigned. Fix to "0".		0	0
23	DN Denormalized Number Zero Flash Bit (Note 2)	0: Handle the denormalized number as a denormalized number 1: Handle the denormalized number as zero	R	W
24	CE Unimplemented Operation Exception Cause Bit	0: No unimplemented operation exception occurred. 1: An unimplemented operation exception occurred. When the bit is set to "1", the execution of an FPU operation instruction will clear it to "0".	R (Note 3)	
25	CX Inexact Exception Cause Bit	0: No inexact exception occurred. 1: An inexact exception occurred. When the bit is set to "1", the execution of an FPU operation instruction will clear it to "0".	R (Note 3)	
26	CU Underflow Exception Cause Bit	0: No underflow exception occurred. 1: An underflow exception occurred. When the bit is set to "1", the execution of an FPU operation instruction will clear it to "0".	R (Note 3)	
27	CZ Zero Divide Exception Cause Bit	0: No zero divide exception occurred. 1: A zero divide exception occurred. When the bit is set to "1", the execution of an FPU operation instruction will clear it to "0".	R (Note 3)	
28	CO Overflow Exception Cause Bit	0: No overflow exception occurred. 1: An overflow exception occurred. When the bit is set to "1", the execution of an FPU operation instruction will clear it to "0".	R (Note 3)	
29	CV Invalid Operation Exception Cause Bit	0: No invalid operation exception occurred. 1: An invalid operation exception occurred. When the bit is set to "1", the execution of an FPU operation instruction will clear it to "0".	R (Note 3)	
30, 31	RM Rounding Mode Selection Bit	00: Round to Nearest 01: Round toward Zero 10: Round toward +Infinity 11: Round toward -Infinity	R	W

Note 1: 'If EIT processing is unexecuted' means whenever one of the exceptions occurs, enable bits 17 to 21 are set to "0" which masks the EIT processing so that it cannot be executed. If two exceptions occur at the same time and their corresponding exception enable bits are set differently (one enabled, and the other masked), EIT processing is executed. In this case, these two flags do not change state regardless of the enable bit settings.

Note 2: If a denormalized number is given to the operand when DN = "0", an unimplemented exception occurs.

Note 3: This bit is cleared by writing "0". Writing "1" has no effect (the bit retains the value it had before the write).

1.3.6 Floating-point Exceptions (FPE)

Floating-point Exception (FPE) occurs when Unimplemented Exception (UIPL) or one of the five exceptions specified in the IEEE754 standard (OVF/UDF/IXCT/DIV0/IVLD) is detected. Each exception processing is outlined below.

(1) Overflow Exception (OVF)

The exception occurs when the absolute value of the operation result exceeds the largest describable precision in the floating-point format. The following table shows the operation results when an OVF occurs.

Rounding Mode	Sign of the Result	Operation Result (Content of the Destination Register)	
		When the OVF EIT processing is masked (Note 1)	When the OVF EIT processing is executed (Note 2)
-infinity	+	+MAX	No change
	-	-infinity	
+infinity	+	+infinity	
	-	-MAX	
0	+	+MAX	
	-	-MAX	
Nearest	+	+infinity	
	-	-infinity	

Note 1: When the Overflow Exception Enable (EO) bit (FPSR register bit 20) = "0"

Note 2: When the Overflow Exception Enable (EO) bit (FPSR register bit 20) = "1"

Note: • If an OVF occurs while EIT processing for OVF is masked, an IXCT occurs at the same time.

• +MAX = H'7F7F FFFF, -MAX = H'FF7F FFFF

(2) Underflow Exception (UDF)

The exception occurs when the absolute value of the operation result is less than the largest describable precision in the floating-point format. The following table shows the operation results when a UDF occurs.

Operation Result (Content of the Destination Register)	
When UDF EIT processing is masked (Note 1)	When UDF EIT processing is executed (Note 2)
DN = 0: An unimplemented exception occurs	No change
DN = 1: 0 is returned	

Note 1: When the Underflow Exception Enable (EU) bit (FPSR register bit 18) = "0"

Note 2: When the Underflow Exception Enable (EU) bit (FPSR register bit 18) = "1"

(3) Inexact Exception (IXCT)

The exception occurs when the operation result differs from a result led out with an infinite range of precision. The following table shows the operation results and the respective conditions in which each IXCT occurs.

Occurrence Condition	Operation Result (Content of the Destination Register)	
	When the IXCT EIT processing is masked (Note 1)	When the IXCT EIT processing is executed (Note 2)
Overflow occurs in OVF masked condition	Reference OVF operation results	No change
Rounding occurs	Rounded value	No change

Note 1: When the Inexact Exception Enable (EX) bit (FPSR register bit 17) = "0"

Note 2: When the Inexact Exception Enable (EX) bit (FPSR register bit 17) = "1"

(4) Zero Division Exception (DIV0)

The exception occurs when a finite nonzero value is divided by zero. The following table shows the operation results when a DIV0 occurs.

Dividend	Operation Result (Content of the Destination Register)	
	When the DIV0 EIT processing is masked (Note 1)	When the DIV0 EIT processing is executed (Note 2)
Nonzero finite value	\pm infinity (Sign is derived by exclusive-ORing the signs of divisor and dividend)	No change

Note 1: When the Zero Division Exception Enable (EZ) bit (FPSR register bit 19) = "0"

Note 2: When the Zero Division Exception Enable (EZ) bit (FPSR register bit 19) = "1"

Please note that the DIV0 EIT processing does not occur in the following conditions.

Dividend	Behavior
0	An invalid operation exception occurs
infinity	No exception occur (with the result "infinity")

(5) Invalid Operation Exception (IVLD)

The exception occurs when an invalid operation is executed. The following table shows the operation results and the respective conditions in which each IVLD occurs.

Occurrence Condition		Operation Result (Content of the Destination Register)	
		When the IVLD EIT processing is masked (Note 1)	When the IVLD EIT processing is executed (Note 2)
Operation for SNaN operand		QNaN	No change
+infinity -(+infinity), -infinity -(-infinity)			
0 X infinity			
0 ÷ 0, infinity ÷ infinity			
When an integer conversion overflowed	When FTOI instruction was executed	Return value when pre-conversion signed bit is: "0" = H'7FFF FFFF "1" = H'8000 0000	No change
	When NaN or Infinity was converted into an integer	When FTOS instruction was executed	
When < or > comparison was performed on NaN		Comparison results (comparison invalid)	

Note 1: When the Invalid Operation Exception Enable (EV) bit (FPSR register bit 21) = "0"

Note 2: When the Invalid Operation Exception Enable (EV) bit (FPSR register bit 21) = "1"

Notes: • NaN (Not a Number)

SNaN (Signaling NaN): a NaN in which the MSB of the decimal fraction is "0". When SNaN is used as the source operand in an operation, an IVLD occurs. SNaNs are useful in identifying program bugs when used as the initial value in a variable. However, SNaNs cannot be generated by hardware.

QNaN (Quiet NaN): a NaN in which the MSB of the decimal fraction is "1". Even when QNaN is used as the source operand in an operation, an IVLD will not occur (excluding comparison and format conversion). Because a result can be checked by the arithmetic operations, QNaN allows the user to debug without executing an EIT processing. QNaNs are created by hardware.

(6) Unimplemented Exception (UIPL)

The exception occurs when the Denormalized Number Zero Flash (DN) bit (FPSR register bit 23) = "0" and a denormalized number is given as an operation operand (Note 1).

Because the UIPL has no enable bits available, it cannot be masked when they occur. The destination register remains unchanged.

Note: • A UDF occurs when the intermediate result of an operation is a denormalized number, in which case if the DN bit (FPSR register bit 23) = "0", an UIPL occurs.

1.4 Accumulator

The Accumulator (ACC) is a 56-bit register used for DSP function instructions. The accumulator is handled as a 64-bit register when accessed for read or write. When reading data from the accumulator, the value of bit 8 is sign-extended. When writing data to the accumulator, bits 0 to 7 are ignored. The accumulator is also used for the multiply instruction "MUL", in which case the accumulator value is destroyed by instruction execution.

Use the MVTACHI and MVTACLO instructions for writing to the accumulator. The MVTACHI and MVTACLO instructions write data to the high-order 32 bits (bits 0-31) and the low-order 32 bits (bits 32-63), respectively.

Use the MVFACHI, MVFACLO, and MVFACMI instructions for reading data from the accumulator. The MVFACHI, MVFACLO and MVFACMI instructions read data from the high-order 32 bits (bits 0-31), the low-order 32 bits (bits 32-63) and the middle 32 bits (bits 16-47), respectively.

At reset release, the value of accumulator is undefined.

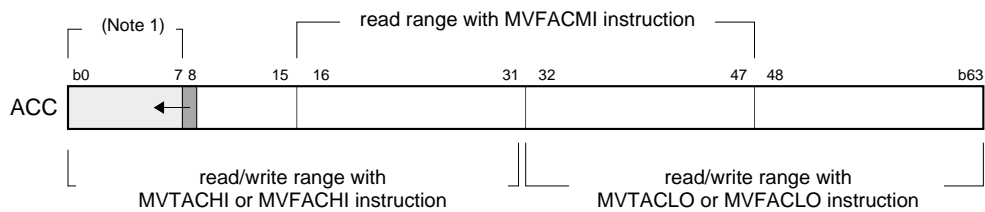

Note 1: When read, bits 0 to 7 always show the sign-extended value of bit 8. Writing to this bit field is ignored.

1.5 Program Counter

The Program Counter (PC) is a 32-bit counter that retains the address of the instruction being executed. Since the M32R CPU instruction starts with even-numbered addresses, the LSB (bit 31) is always "0".

At reset release, the value of the PC is "H'0000 0000."

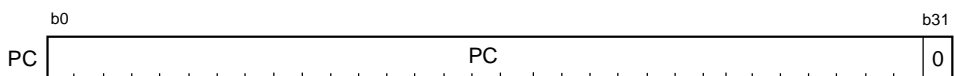

1.6 Data Format

1.6.1 Data Type

The data types that can be handled by the M32R-FPU instruction set are signed or unsigned 8, 16, and 32-bit integers and single-precision floating-point numbers. The signed integers are represented by 2's complements.

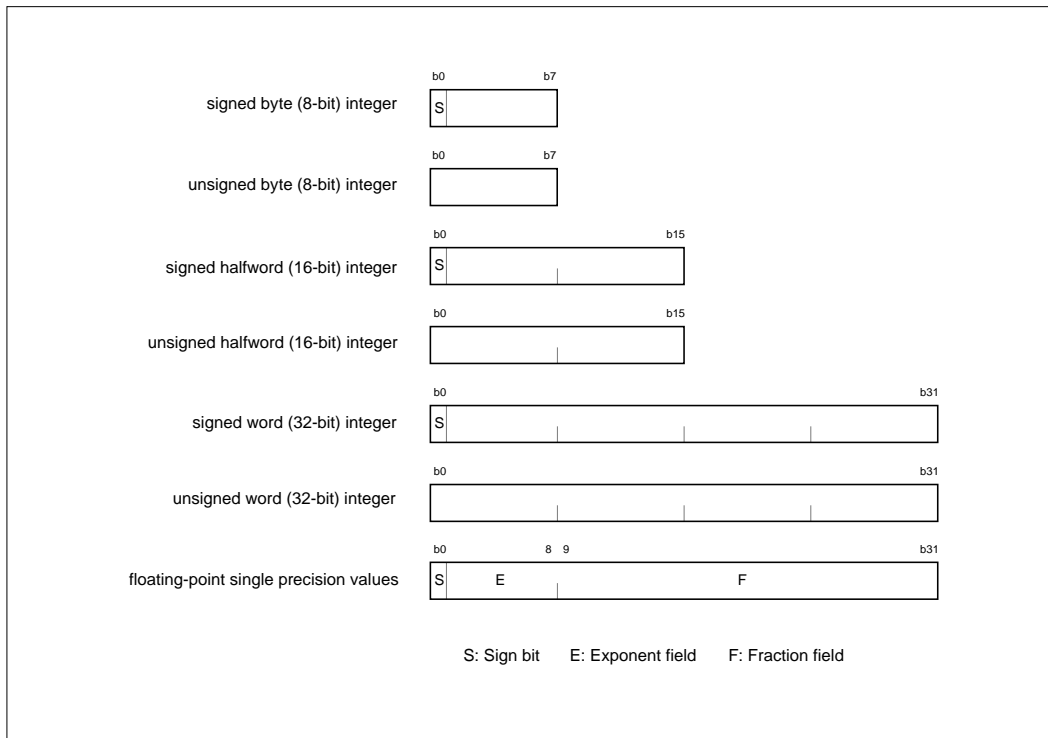

Figure 1.6.1 Data Type

1.6.2 Data Format

(1) Data format in a register

The data sizes in the M32R-FPU registers are always words (32 bits).

When loading byte (8-bit) or halfword (16-bit) data from memory into a register, the data is sign-extended (**LDB**, **LDH** instructions) or zero-extended (**LDUB**, **LDUH** instructions) to a word (32-bit) quantity before being loaded into the register.

When storing data from a register into a memory, the 32-bit data, the 16-bit data on the LSB side and the 8-bit data on the LSB side of the register are stored into memory by the **ST**, **STH** and **STB** instructions, respectively.

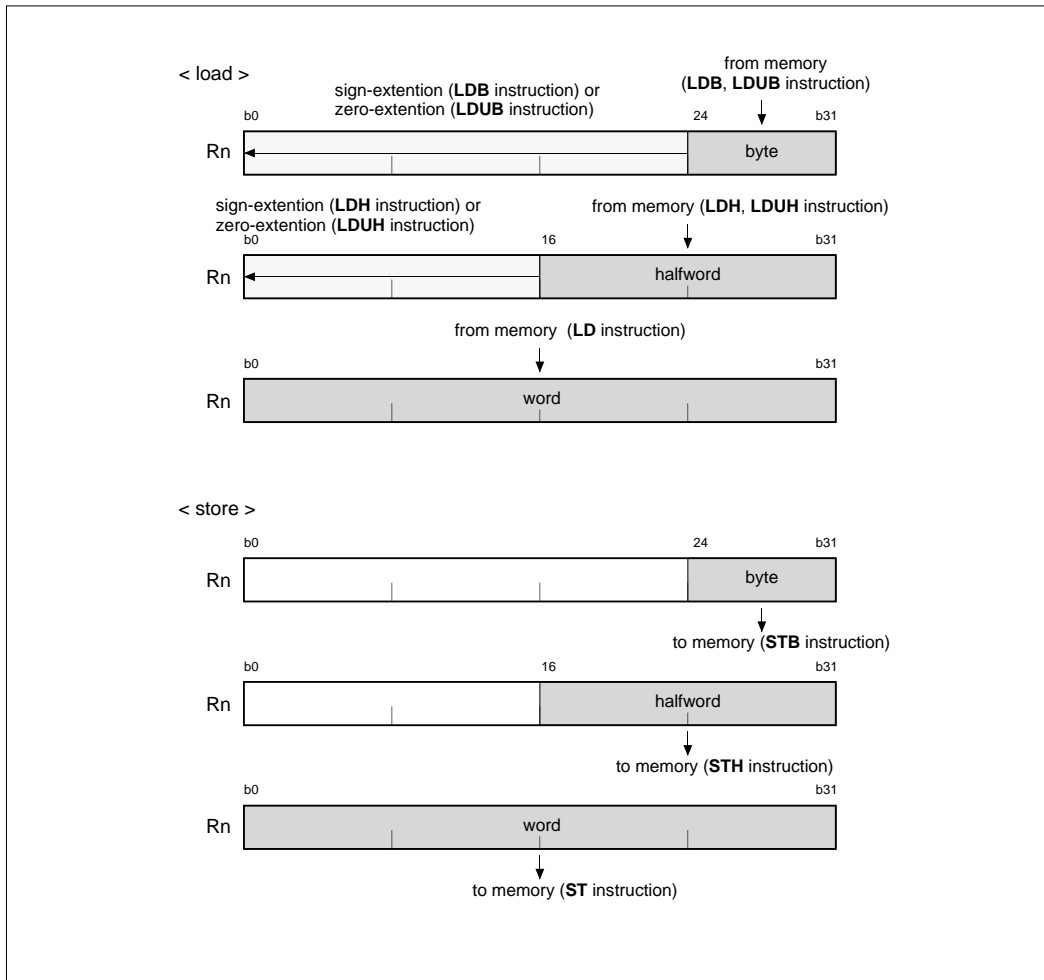

Figure 1.6.2 Data Format in a Register

(2) Data format in memory

The data sizes in memory can be byte (8 bits), halfword (16 bits) or word (32 bits). Although byte data can be located at any address, halfword and word data must be located at the addresses aligned with a halfword boundary (least significant address bit = "0") or a word boundary (two low-order address bits = "00"), respectively. If an attempt is made to access memory data that overlaps the halfword or word boundary, an address exception occurs.

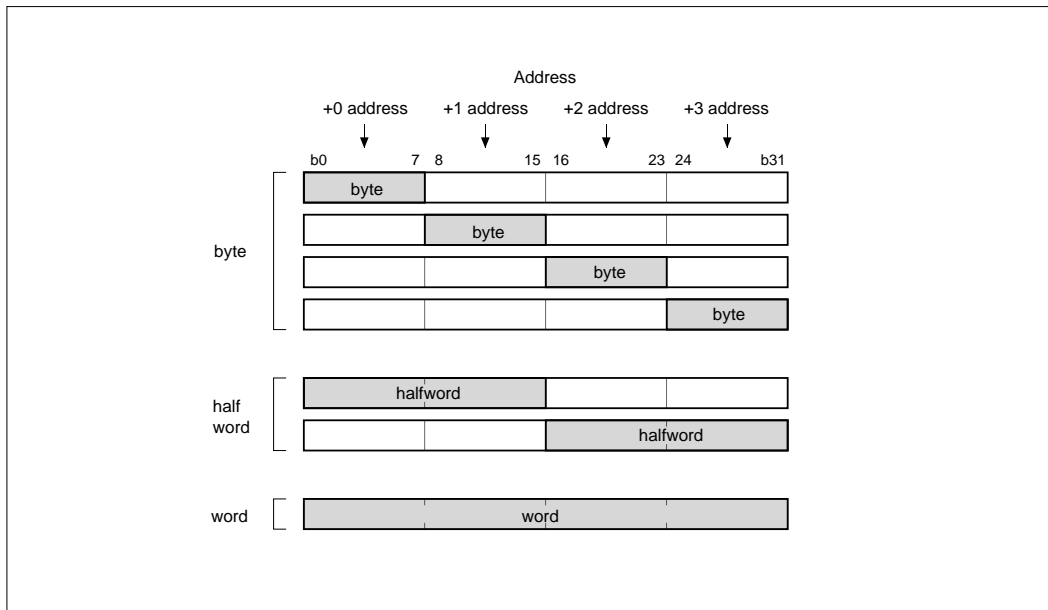

Figure 1.6.3 Data Format in Memory

1.7 Addressing Mode

M32R-FPU supports the following addressing modes.

(1) Register direct [**R or CR**]

The general-purpose register or the control register to be processed is specified.

(2) Register indirect [**@R**]

The contents of the register specify the address of the memory. This mode can be used by all load/store instructions.

(3) Register relative indirect [**@(disp, R)**]

(The contents of the register) + (16-bit immediate value which is sign-extended to 32 bits) specify the address of the memory.

(4) Register indirect and register update

- Adds 4 to register contents [**@R+**]
The contents of the register specify the memory address, then 4 is added to the register contents.
(Can only be specified with LD instruction).
- Add 2 to register contents [**@R+**] [**M32R-FPU extended addressing mode**]
The contents of the register specify the memory address, then 2 is added to the register contents.
(Can only be specified with STH instruction).
- Add 4 to register contents [**@+R**]
The contents of the register is added by 4, the register contents specify the memory address.
(Can only be specified with ST instruction).
- Subtract 4 to register contents [**@-R**]
The content of the register is decreased by 4, then the register contents specify the memory address.
(Can only be specified with ST instruction).

(5) immediate [**#imm**]

The 4-, 5-, 8-, 16- or 24-bit immediate value.

(6) PC relative [**pcdisp**]

(The contents of PC) + (8, 16, or 24-bit displacement which is sign-extended to 32 bits and 2 bits left-shifted) specify the address of memory.

This page left blank intentionally.

CHAPTER 2

INSTRUCTION SET

2.1 Instruction set overview

2.2 Instruction format

2.1 Instruction set overview

The M32R-FPU has a total of 100 instructions. The M32R-FPU has a RISC architecture. Memory is accessed by using the load/store instructions and other operations are executed by using register-to-register operation instructions.

M32R CPU supports compound instructions such as "load & address update" and "store & address update" which are useful for high-speed data transfer.

2.1.1 Load/store instructions

The load/store instructions carry out data transfers between a register and a memory.

LD	Load
LDB	Load byte
LDUB	Load unsigned byte
LDH	Load halfword
LDUH	Load unsigned halfword
LOCK	Load locked
ST	Store
STB	Store byte
STH	Store halfword
UNLOCK	Store unlocked

Three types of addressing modes can be specified for load/store instructions.

(1) Register indirect

The contents of the register specify the address. This mode can be used by all load/store instructions.

(2) Register relative indirect

(The contents of the register) + (32-bit sign-extended 16-bit immediate value) specifies the address. This mode can be used by all except **LOCK** and **UNLOCK** instructions.

(3) Register indirect and register update

- Adds 4 to register contents [**@R+**]
The contents of the register specify the memory address, then 4 is added to the register contents.
(Can only be specified with LD instruction).
- Add 2 to register contents [**@R+**] [**M32R-FPU extended addressing mode**]
The contents of the register specify the memory address, then 2 is added to the register contents.
(Can only be specified with STH instruction).
- Add 4 to register contents [**@+R**]
The contents of the register is added by 4, the register contents specify the memory address.
(Can only be specified with ST instruction).
- Subtract 4 to register contents [**@-R**]
The content of the register is decreased by 4, then the register contents specify the memory address.
(Can only be specified with ST instruction).

When accessing halfword and word size data, it is necessary to specify the address on the halfword boundary or the word boundary (Halfword size should be such that the low-order 2 bits of the address are "00" or "10", and word size should be such that the low order 2 bits of the address are "00"). If an unaligned address is specified, an address exception occurs.

When accessing byte data or halfword data with load instructions, the high-order bits are sign-extended or zero-extended to 32 bits, and loaded to a register.

2.1.2 Transfer instructions

The transfer instructions carry out data transfers between registers or a register and an immediate value.

LD24	Load 24-bit immediate
LDI	Load immediate
MV	Move register
MVFC	Move from control register
MVTC	Move to control register
SETH	Set high-order 16-bit

2.1.3 Operation instructions

Compare, arithmetic/logic operation, multiply and divide, and shift are carried out between registers.

- compare instructions

CMP	Compare
CMPI	Compare immediate
CMPU	Compare unsigned
CMPUI	Compare unsigned immediate

- arithmetic operation instructions

ADD	Add
ADD3	Add 3-operand
ADDI	Add immediate
ADDV	Add with overflow checking
ADDV3	Add 3-operand with overflow checking
ADDX	Add with carry
NEG	Negate
SUB	Subtract
SUBV	Subtract with overflow checking
SUBX	Subtract with borrow

- logic operation instructions

AND	AND
AND3	AND 3-operand
NOT	Logical NOT
OR	OR
OR3	OR 3-operand
XOR	Exclusive OR
XOR3	Exclusive OR 3-operand

- multiply/divide instructions

DIV	Divide
DIVU	Divide unsigned
MUL	Multiply
REM	Remainder
REMU	Remainder unsigned

- shift instructions

SLL	Shift left logical
SLL3	Shift left logical 3-operand
SLLI	Shift left logical immediate
SRA	Shift right arithmetic
SRA3	Shift right arithmetic 3-operand
SRAI	Shift right arithmetic immediate
SRL	Shift right logical
SRL3	Shift right logical 3-operand
SRLI	Shift right logical immediate

2.1.4 Branch instructions

The branch instructions are used to change the program flow.

BC	Branch on C-bit
BEQ	Branch on equal to
BEQZ	Branch on equal to zero
BGEZ	Branch on greater than or equal to zero
BGTZ	Branch on greater than zero
BL	Branch and link
BLEZ	Branch on less than or equal to zero
BLTZ	Branch on less than zero
BNC	Branch on not C-bit
BNE	Branch on not equal to
BNEZ	Branch on not equal to zero
BRA	Branch
JL	Jump and link
JMP	Jump
NOP	No operation

Only a word-aligned (word boundary) address can be specified for the branch address.

The addressing mode of the **BRA**, **BL**, **BC** and **BNC** instructions can specify an 8-bit or 24-bit immediate value. The addressing mode of the **BEQ**, **BNE**, **BEQZ**, **BNEZ**, **BLTZ**, **BGEZ**, **BLEZ**, and **BGTZ** instructions can specify a 16-bit immediate value.

In the **JMP** and **JL** instructions, the register value becomes the branch address. However, the low-order 2-bit value of the register is ignored. In other branch instructions, (PC value of branch instruction) + (sign-extended and 2 bits left-shifted immediate value) becomes the branch address. However, the low order 2-bit value of the address becomes "00" when addition is carried out. For example, refer to **Figure 2.1.1**. When instruction A or B is a branch instruction, branching to instruction G, the immediate value of either instruction A or B becomes 4.

Simultaneous with execution of branching by the **JL** or **BL** instructions for subroutine calls, the PC value of the return address is stored in R14. The low-order 2-bit value of the address stored in R14 (PC value of the branch instruction + 4) is always cleared to "0". For example, refer to **Figure 2.1.1**. If an instruction A or B is a **JL** or **BL** instruction, the return address becomes that of the instruction C.

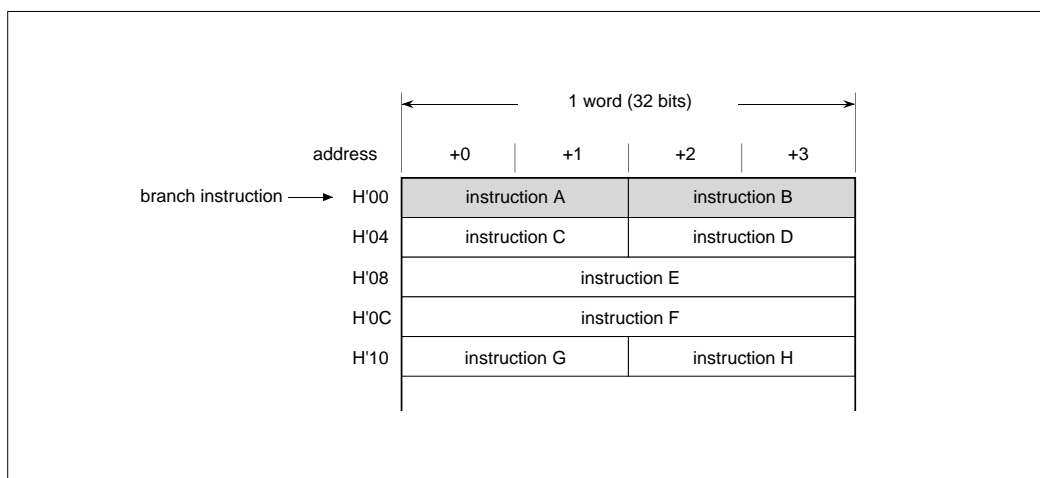

Fig. 2.1.1 Branch addresses of branch instruction

2.1.5 EIT-related instructions

The EIT-related instructions carry out the EIT events (Exception, Interrupt and Trap). Trap initiation and return from EIT are EIT-related instructions.

TRAP	Trap
RTE	Return from EIT

2.1.6 DSP function instructions

The DSP function instructions carry out multiplication of 32 bits x 16 bits and 16 bits x 16 bits or multiply and add operation; there are also instructions to round off data in the accumulator and carry out transfer of data between the accumulator and a general-purpose register.

MACHI	Multiply-accumulate high-order halfwords
MACLO	Multiply-accumulate low-order halfwords
MACWHI	Multiply-accumulate word and high-order halfword
MACWLO	Multiply-accumulate word and low-order halfword
MULHI	Multiply high-order halfwords
MULLO	Multiply low-order halfwords
MULWHI	Multiply word and high-order halfword
MULWLO	Multiply word and low-order halfword
MVFACHI	Move high-order word from accumulator
MVFACLO	Move low-order word from accumulator
MVFACMI	Move middle-order word from accumulator
MVTACHI	Move high-order word to accumulator
MVTACLO	Move low-order word to accumulator
RAC	Round accumulator
RACH	Round accumulator halfword

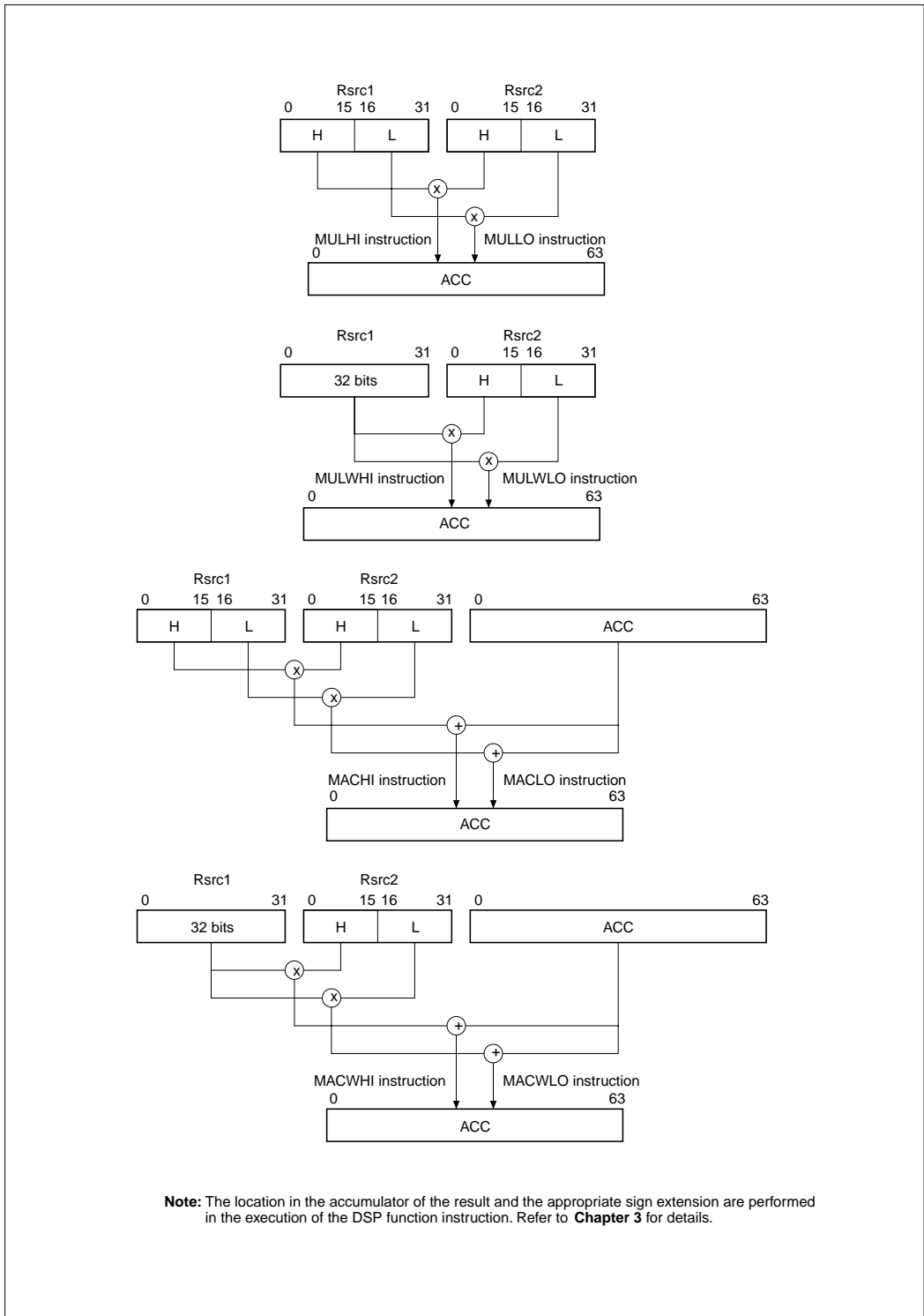

Fig. 2.1.2 DSP function instruction operation 1 (multiply, multiply and accumulate)

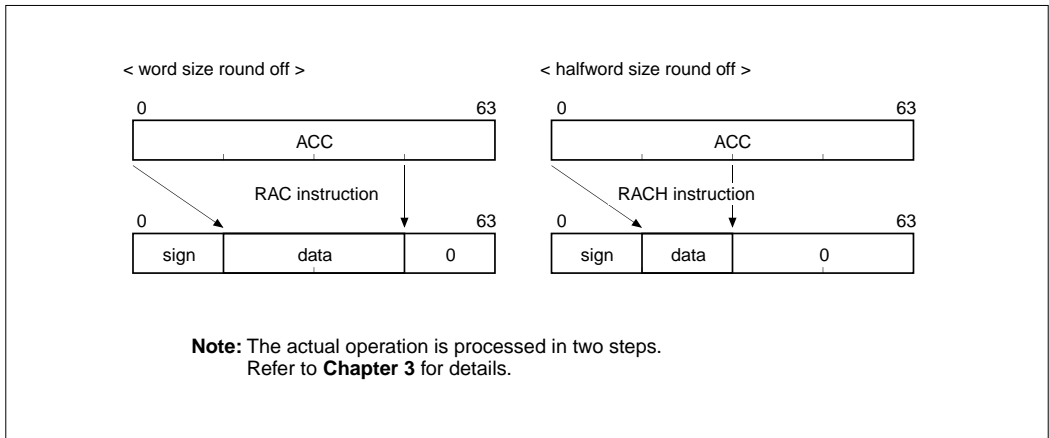

Fig. 2.1.3 DSP function instruction operation 2 (round off)

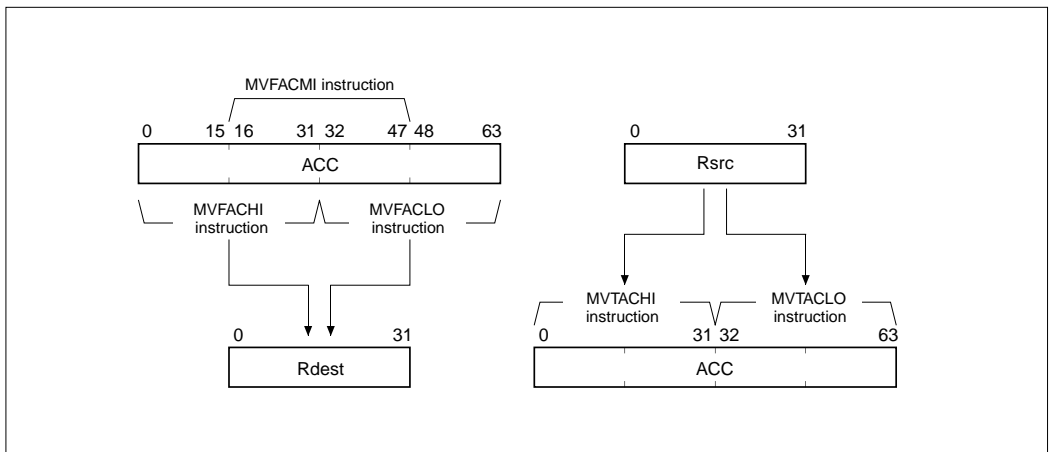

Fig. 2.1.4 DSP function instruction operation 3 (transfer between accumulator and register)

2.1.7 Floating-point Instructions

The following instructions execute floating-point operations.

FADD	Floating-point add
FSUB	Floating-point subtract
FMUL	Floating-point multiply
FDIV	Floating-point divide
FMADD	Floating-point multiply and add
FMSUB	Floating-point multiply and subtract
ITOF	Integer to float
UTOF	Unsigned integer to float
FTOI	Float to integer
FTOS	Float to short
FCMP	Floating-point compare
FCMPE	Floating-point compare with exception if unordered

2.1.8 Bit Operation Instructions

These instructions determine the operation of the bit specified by the register or memory.

BSET	Bit set
BCLR	Bit clear
BTST	Bit test
SETPSW	Set PSW
CLRPSW	Clear PSW

2.2 Instruction format

There are two major instruction formats: two 16-bit instructions packed together within a word boundary, and a single 32-bit instruction (see **Figure 2.2.1**). Figure 2.2.2 shows the instruction format of M32R CPU.

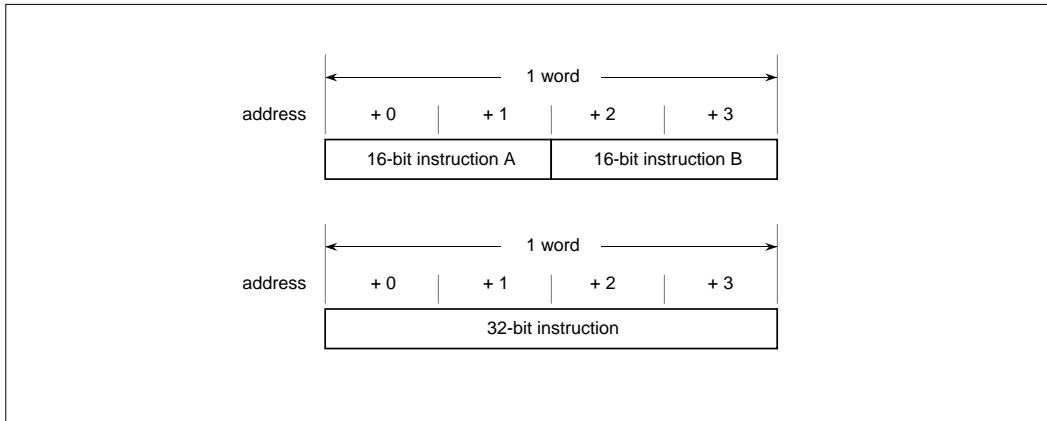

Fig. 2.2.1 16-bit instruction and 32-bit instruction

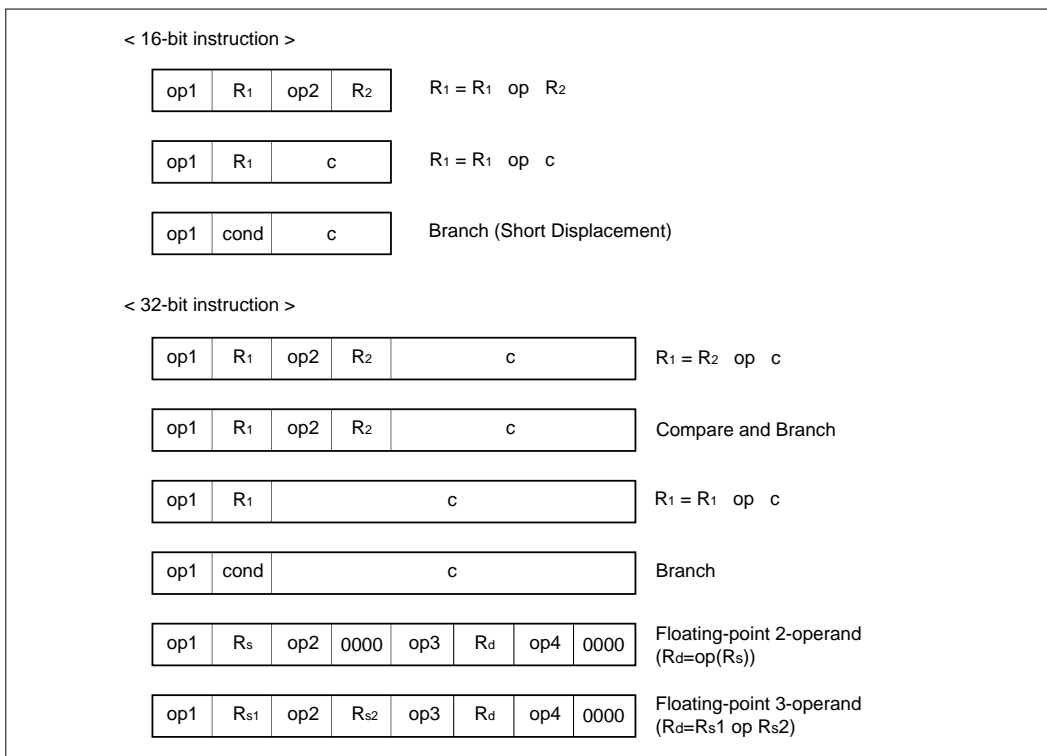

Fig. 2.2.2 Instruction format of M32R CPU

The MSB (Most Significant Bit) of a 32-bit instruction is always "1". The MSB of a 16-bit instruction in the high-order halfword is always "0" (instruction A in Figure 2.2.3), however the processing of the following 16-bit instruction depends on the MSB of the instruction.

In Figure 2.2.3, if the MSB of the instruction B is "0", instructions A and B are executed sequentially; B is executed after A. If the MSB of the instruction B is "1", instructions A and B are executed in parallel.

The current implementation allows only the NOP instruction as instruction B for parallel execution. The MSB of the NOP instruction used for word arrangement adjustment is changed to "1" automatically by a standard Mitsubishi assembler, then the M32R-FPU can execute this instruction without requiring any clock cycles.

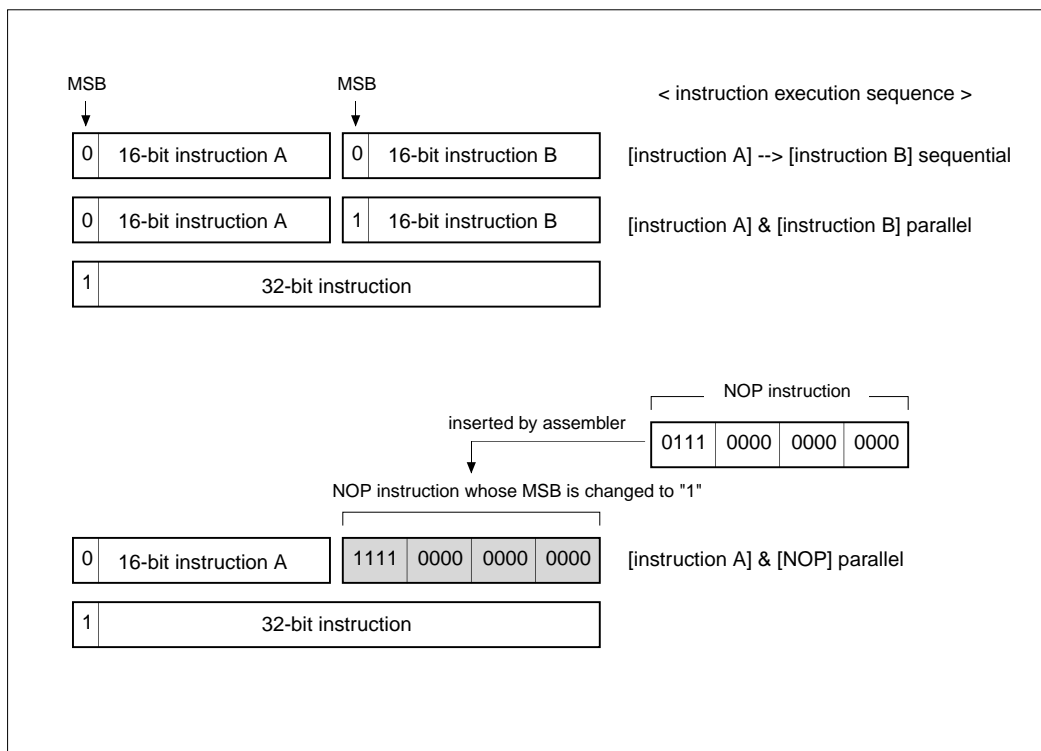

Fig. 2.2.3 Processing of 16-bit instructions

This page left blank intentionally.

CHAPTER 3

INSTRUCTIONS

- 3.1 Conventions for instruction description
- 3.2 Instruction description

3.1 Conventions for instruction description

Conventions for instruction description are summarized below.

[Mnemonic]

Shows the mnemonic and possible operands (operation target) using assembly language notation.

Table 3.1.1 Operand list

symbol(see note)	addressing mode	operation target
R	register direct	general-purpose registers (R0 - R15)
CR	control register	Mcontrol registers (CR0 = PSW, CR1 = CBR, CR2 = SPI, CR3 = SPU, CR6 = BPC, CR7 = FPSR)
@R	register indirect	memory specified by register contents as address
@(disp,R)	register relative indirect	memory specified by (register contents) + (sign-extended value of 16-bit displacement) as address
@R+	register indirect and register update	Add 4 to register contents. (Register contents specify the memory address, then 4 is added to the contents.)
@+R	register indirect and register update	Add 4 to register contents. (4 is added to the register contents, then the register contents specify the memory address.)
@-R	register indirect and register update	Subtract 4 to register contents. (4 is subtract to the register contents, then the register contents specify the memory address.)
#imm	immediate	immediate value (refer to each instruction description)
#bitpos	Bit position	Contents of byte data bit position
pcdisp	PC relative	memory specified by (PC contents) + (8, 16, or 24-bit displacement which is sign-extended to 32 bits and 2 bits left-shifted) as address

Note: When expressing Rsrc or Rdest as an operand, a general-purpose register numbers (0 - 15) should be substituted for src or dest. When expressing CRsrc or CRdest, control register numbers (0 - 3, 6, 7) should be substituted for src or dest.

[Function]

Indicates the operation performed by one instruction. Notation is in accordance with C language notation.

Table 3.1.2 Operation expression (operator)

operator	meaning
+	addition (binomial operator)
-	subtraction (binomial operator)
*	multiplication (binomial operator)
/	division (binomial operator)
%	remainder operation (binomial operator)
++	increment (monomial operator)
--	decrement (monomial operator)

Table 3.1.3 Operation expression (operator) (cont.)

operator	meaning
-	sign invert (monomial operator)
=	substitute right side into left side (substitute operator)
+=	adds right and left variables and substitute into left side (substitute operator)
-=	subtract right variable from left variable and substitute into left side (substitute operator)
>	greater than (relational operator)
<	less than (relational operator)
>=	greater than or equal to (relational operator)
<=	less than or equal to (relational operator)
==	equal (relational operator)
!=	not equal (relational operator)
&&	AND (logical operator)
	OR (logical operator)
!	NOT (logical operator)
?:	execute a conditional expression (conditional operator)

Table 3.1.4 Operation expression (bit operator)

operator	meaning
<<	bits are left-shifted
>>	bits are right-shifted
&	bit product (AND)
	bit sum (OR)
^	bit exclusive or (EXOR)
~	bit invert

Table 3.1.5 Data type

expression	sign	bit length	range
signed char	yes	8	-128 to +127
signed short	yes	16	-32,768 to +32,767
signed int	yes	32	-2,147,483,648 to +2,147,483,647
unsigned char	no	8	0 to 255
unsigned short	no	16	0 to 655,535
unsigned int	no	32	0 to 4,294,967,295
signed64bit	yes	64	signed 64-bit integer (with accumulator)

Table 3.1.6 Data type (floating-point)

expression	floating-point format
float	single precision values format

[Description]

Describes the operation performed by the instruction and any condition bit change.

[EIT occurrence]

Shows possible EIT events (Exception, Interrupt, Trap) which may occur as the result of the instruction's execution. Only address exception (AE), floating-point exception (FPE) and trap (TRAP) may result from an instruction execution.

[Instruction format]

Shows the bit level instruction pattern (16 bits or 32 bits). Source and/or destination register numbers are put in the src and dest fields as appropriate. Any immediate or displacement value is put in the imm or disp field, its maximum size being determined by the width of the field provided for the particular instruction. Refer to **2.2 Instruction format** for detail.

3.2 Instruction description

This section lists M32R-FPU instructions in alphabetical order. Each page is laid out as shown below.

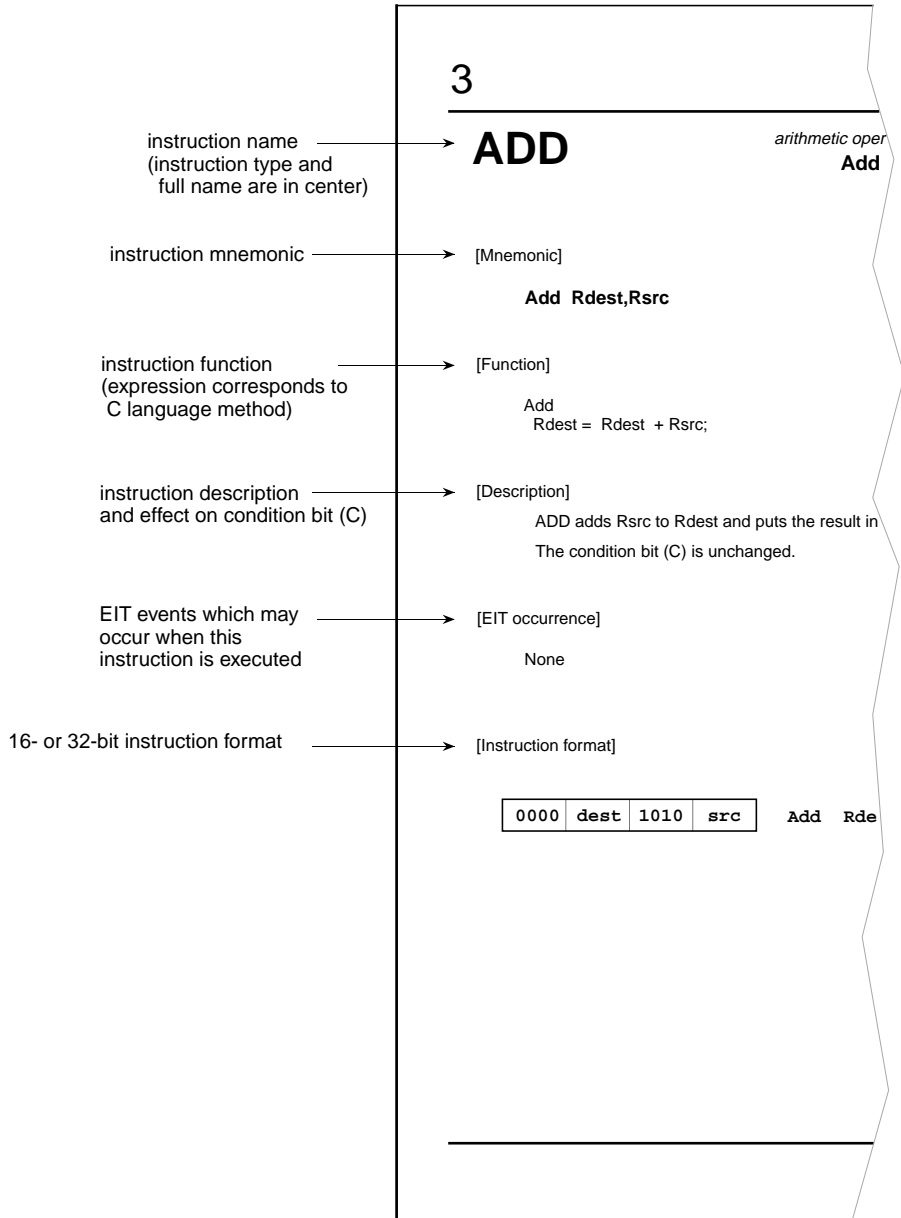

ADD*arithmetic/logic operation***Add****ADD****[Mnemonic]****ADD Rdest,Rsrc****[Function]**

Add

 $Rdest = Rdest + Rsrc;$ **[Description]**

ADD adds Rsrc to Rdest and puts the result in Rdest.

The condition bit (C) is unchanged.

[EIT occurrence]

None

[Encoding]

0000	dest	1010	src
------	------	------	-----

ADD Rdest,Rsrc

ADD3*arithmetic operation instruction***Add 3-operand****ADD3****[Mnemonic]**`ADD3 Rdest,Rsrc,#imm16`**[Function]**

Add

 $Rdest = Rsrc + (\text{signed short}) \text{imm16};$ **[Description]**

ADD3 adds the 16-bit immediate value to Rsrc and puts the result in Rdest. The immediate value is sign-extended to 32 bits before the operation.

The condition bit (C) is unchanged.

[EIT occurrence]

None

[Encoding]

1000	dest	1010	src	imm16	
------	------	------	-----	-------	--

`ADD3 Rdest,Rsrc,#imm16`

ADDI*arithmetic operation instruction*
Add immediate**ADDI****[Mnemonic]****ADDI Rdest, #imm8****[Function]**

Add

Rdest = Rdest + (signed char) imm8;

[Description]

ADDI adds the 8-bit immediate value to Rdest and puts the result in Rdest.
The immediate value is sign-extended to 32 bits before the operation.
The condition bit (C) is unchanged.

[EIT occurrence]

None

[Encoding]

0100	dest	imm8
------	------	------

ADDI Rdest, #imm8

ADDV

arithmetic operation instruction
Add with overflow checking

ADDV**[Mnemonic]**

ADDV Rdest,Rsrc

[Function]

Add

$Rdest = (\text{signed}) Rdest + (\text{signed}) Rsrc;$
 $C = \text{overflow} ? 1 : 0;$

[Description]

ADDV adds Rsrc to Rdest and puts the result in Rdest.

The condition bit (C) is set when the addition results in overflow; otherwise it is cleared.

[EIT occurrence]

None

[Encoding]

0000	dest	1000	src
------	------	------	-----

ADDV Rdest,Rsrc

ADDV3*arithmetic operation instruction***Add 3-operand with overflow checking****ADDV3****[Mnemonic]****ADDV3 Rdest,Rsrc,#imm16****[Function]**

Add

 $Rdest = (\text{signed}) Rsrc + (\text{signed}) ((\text{signed short}) \text{imm16});$ $C = \text{overflow} ? 1 : 0;$ **[Description]**

ADDV3 adds the 16-bit immediate value to Rsrc and puts the result in Rdest. The immediate value is sign-extended to 32 bits before it is added to Rsrc.

The condition bit (C) is set when the addition results in overflow; otherwise it is cleared.

[EIT occurrence]

None

[Encoding]

1000	dest	1000	src	imm16
------	------	------	-----	-------

ADDV3 Rdest,Rsrc,#imm16

ADDX*arithmetic operation instruction***Add with carry****ADDX****[Mnemonic]****ADDX Rdest, Rsrc****[Function]**

Add

 $Rdest = (\text{unsigned}) Rdest + (\text{unsigned}) Rsrc + C;$ $C = \text{carry_out} ? 1 : 0;$ **[Description]**

ADDX adds Rsrc and C to Rdest, and puts the result in Rdest.

The condition bit (C) is set when the addition result cannot be represented by a 32-bit unsigned integer; otherwise it is cleared.

[EIT occurrence]

None

[Encoding]

0000	dest	1001	src
------	------	------	-----

ADDX Rdest, Rsrc

AND*logic operation instruction***AND****AND****[Mnemonic]****AND Rdest,Rsrc****[Function]**

Logical AND

Rdest = Rdest & Rsrc;

[Description]

AND computes the logical AND of the corresponding bits of Rdest and Rsrc and puts the result in Rdest.

The condition bit (C) is unchanged.

[EIT occurrence]

None

[Encoding]

0000	dest	1100	src
------	------	------	-----

AND Rdest,Rsrc

AND3*logic operation instruction***AND 3-operand****AND3****[Mnemonic]****AND3 Rdest,Rsrc,#imm16****[Function]**

Logical AND

Rdest = Rsrc & (unsigned short) imm16;

[Description]

AND3 computes the logical AND of the corresponding bits of Rsrc and the 16-bit immediate value, which is zero-extended to 32 bits, and puts the result in Rdest.

The condition bit (C) is unchanged.

[EIT occurrence]

None

[Encoding]

1000	dest	1100	src	imm16			
------	------	------	-----	-------	--	--	--

AND3 Rdest,Rsrc,#imm16

BC*branch instruction***Bit clear****BC****M32R-FPU Extended Instruction****[Mnemonic]**

- (1) BC `pcdisp8`
- (2) BC `pcdisp24`

[Function]

Branch

- (1) if (C==1) PC = (PC & 0xfffffc) + ((signed char) pcdisp8) << 2 ;
 - (2) if (C==1) PC = (PC & 0xfffffc) + (sign_extend (pcdisp24) << 2) ;
- where
- ```
#define sign_extend(x) (((signed) (x)<< 8) >>8)
```

**[Description]**

BC causes a branch to the specified label when the condition bit (C) is 1.

There are two instruction formats; which allows software, such as an assembler, to decide on the better format.

The condition bit (C) is unchanged.

**[EIT occurrence]**

None

**[Encoding]**

|      |      |         |          |         |          |
|------|------|---------|----------|---------|----------|
| 0111 | 1100 | pcdisp8 | BC       | pcdisp8 |          |
| 1111 | 1100 |         | pcdisp24 | BC      | pcdisp24 |

**BCLR***bit operation***Bit clear****BCLR****[M32R-FPU Extended Instruction]****[Mnemonic]****BCLR #bitpos,@(disp16,Rsrc)****[Function]**

Bit operation for memory contents Set 0 to specified bit.

\* ( signed char\* ) ( Rsrc + ( signed short ) disp16 ) &amp; = ~ ( 1&lt;&lt; ( 7-bitpos ) ) ;

**[Description]**

BCLR reads the byte data in the memory at the address specified by the Rsrc combined with the 16-bit displacement, and then stores the value of the bit that was specified by bitpos to be set to "0". The displacement is sign-extended before the address calculation. bitpos becomes 0 to 7; MSB becomes 0 and LSB becomes 7. The memory is accessed in bytes. The LOCK bit is on while the BCLR instruction is executed, and is cleared when the execution is completed. The LOCK bit is internal to the CPU and cannot be directly read or written to by the user.

Condition bit C remains unchanged.

The LOCK bit is internal to the CPU and is the control bit for receiving all bus right requests from circuits other than the CPU.

Refer to the Users Manual for non-CPU bus right requests, as the handling differs according to the type of MCU.

**[EIT occurrence]**

None

**[Encoding]**

|      |   |        |      |     |        |
|------|---|--------|------|-----|--------|
| 1010 | 0 | bitpos | 0111 | src | disp16 |
|------|---|--------|------|-----|--------|

**BCLR #bitpos,@(disp16,Rsrc)**

**BEQ**

*branch instruction*  
**Branch on equal to**

**BEQ****[Mnemonic]**

**BEQ Rsrc1,Rsrc2,pcdisp16**

**[Function]**

Branch

if ( Rsrc1 == Rsrc2 ) PC = ( PC & 0xfffffc ) + ( ( signed short ) pcdisp16 ) << 2;

**[Description]**

BEQ causes a branch to the specified label when Rsrc1 is equal to Rsrc2.  
 The condition bit (C) is unchanged.

**[EIT occurrence]**

None

**[Encoding]**

|      |      |      |      |          |
|------|------|------|------|----------|
| 1011 | src1 | 0000 | src2 | pcdisp16 |
|------|------|------|------|----------|

**BEQ Rsrc1,Rsrc2,pcdisp16**

**BEQZ**

*branch instruction*  
**Branch on equal to zero**

**BEQZ****[Mnemonic]**

**BEQZ** *Rsrc,pcdisp16*

**[Function]**

Branch

if ( *Rsrc* == 0 ) PC = ( PC & 0xffffffc ) + ( ( ( signed short ) *pcdisp16* ) << 2);

**[Description]**

BEQZ causes a branch to the specified label when *Rsrc* is equal to zero.

The condition bit (C) is unchanged.

**[EIT occurrence]**

None

**[Encoding]**

|      |      |      |            |                 |
|------|------|------|------------|-----------------|
| 1011 | 0000 | 1000 | <i>src</i> | <i>pcdisp16</i> |
|------|------|------|------------|-----------------|

**BEQZ** *Rsrc,pcdisp16*

**BGEZ***branch instruction***Branch on greater than or equal to zero****BGEZ****[Mnemonic]****BGEZ Rsrc,pcdisp16****[Function]**

Branch

$$\text{if } ((\text{signed}) \text{Rsrc} \geq 0) \text{ PC} = (\text{PC} \& 0\text{xfffffc}) + (((\text{signed short}) \text{pcdisp16}) \ll 2);$$
**[Description]**

BGEZ causes a branch to the specified label when Rsrc treated as a signed 32-bit value is greater than or equal to zero.

The condition bit (C) is unchanged.

**[EIT occurrence]**

None

**[Encoding]**

|      |      |      |     |          |  |  |  |
|------|------|------|-----|----------|--|--|--|
| 1011 | 0000 | 1011 | src | pcdisp16 |  |  |  |
|------|------|------|-----|----------|--|--|--|

**BGEZ Rsrc,pcdisp16**



**BGTZ**

*branch instruction*  
**Branch on greater than zero**

**BGTZ****[Mnemonic]**

**BGTZ Rsrc,pcdisp16**

**[Function]**

Branch

if ((signed) Rsrc > 0) PC = (PC & 0xfffffc) + ( (signed short) pcdisp16 ) << 2;

**[Description]**

BGTZ causes a branch to the specified label when Rsrc treated as a signed 32-bit value is greater than zero.

The condition bit (C) is unchanged.

**[EIT occurrence]**

None

**[Encoding]**

|      |      |      |     |          |  |  |  |
|------|------|------|-----|----------|--|--|--|
| 1011 | 0000 | 1101 | src | pcdisp16 |  |  |  |
|------|------|------|-----|----------|--|--|--|

**BGTZ Rsrc,pcdisp16**

**BL***branch instruction*  
**Branch and link****BL****[Mnemonic]**

- (1) **BL** `pcdisp8`
- (2) **BL** `pcdisp24`

**[Function]**

Subroutine call (PC relative)

- (1)  $R14 = (PC \& 0xfffffc) + 4;$   
 $PC = (PC \& 0xfffffc) + ((\text{signed char } pcdisp8) \ll 2);$
  - (2)  $R14 = (PC \& 0xfffffc) + 4;$   
 $PC = (PC \& 0xfffffc) + (\text{sign\_extend}(pcdisp24) \ll 2);$
- where
- ```
#define sign_extend(x) (((signed)(x) << 8) >> 8)
```

[Description]

BL causes an unconditional branch to the address specified by the label and puts the return address in R14.

There are two instruction formats; this allows software, such as an assembler, to decide on the better format.

The condition bit (C) is unchanged.

[EIT occurrence]

None

[Encoding]

0111	1110	pcdisp8	BL	pcdisp8	
1111	1110		pcdisp24	BL	pcdisp24

BLEZ*branch instruction***Branch on less than or equal to zero****BLEZ****[Mnemonic]****BLEZ Rsrc,pcdisp16****[Function]**

Branch

if ((signed) Rsrc <= 0) PC = (PC & 0xfffffc) + (((signed short) pcdisp16) << 2);

[Description]

BLEZ causes a branch to the specified label when the contents of Rsrc treated as a signed 32-bit value, is less than or equal to zero.

The condition bit (C) is unchanged.

[EIT occurrence]

None

[Encoding]

1011	0000	1100	src	pcdisp16			
------	------	------	-----	----------	--	--	--

BLEZ Rsrc,pcdisp16

BLTZ

branch instruction
Branch on less than zero

BLTZ**[Mnemonic]**

BLTZ *Rsrc,pcdisp16*

[Function]

Branch

if ((signed) *Rsrc* < 0) PC = (PC & 0xfffffc) + (((signed short) *pcdisp16*) << 2);

[Description]

BLTZ causes a branch to the specified label when *Rsrc* treated as a signed 32-bit value is less than zero.

The condition bit (C) is unchanged.

[EIT occurrence]

None

[Encoding]

1011	0000	1010	src	pcdisp16			
------	------	------	-----	----------	--	--	--

BLTZ *Rsrc,pcdisp16*

BNC

branch instruction
Branch on not C-bit

BNC**[Mnemonic]**

- (1) **BNC** `pcdisp8`
- (2) **BNC** `pcdisp24`

[Function]

Branch

(1) if (C==0) PC = (PC & 0xfffffc) + ((signed char) pcdisp8) << 2);

(2) if (C==0) PC = (PC & 0xfffffc) + (sign_extend (pcdisp24) << 2);

where

```
#define sign_extend(x) ( ( signed ) ( ( x ) << 8 ) ) >> 8 )
```

[Description]

BNC branches to the specified label when the condition bit (C) is 0.

There are two instruction formats; this allows software, such as an assembler, to decide on the better format.

The condition bit (C) is unchanged.

[EIT occurrence]

None

[Encoding]

0111	1101	pcdisp8	BNC	<code>pcdisp8</code>
1111	1101			<code>pcdisp24</code> BNC <code>pcdisp24</code>

BNE

branch instruction
Branch on not equal to

BNE**[Mnemonic]**

BNE Rsrc1,Rsrc2,pcdisp16

[Function]

Branch

if (Rsrc1 != Rsrc2) PC = (PC & 0xfffffc) + (((signed short) pcdisp16) << 2);

[Description]

BNE causes a branch to the specified label when Rsrc1 is not equal to Rsrc2.
 The condition bit (C) is unchanged.

[EIT occurrence]

None

[Encoding]

1011	src1	0001	src2	pcdisp16
------	------	------	------	----------

BNE Rsrc1,Rsrc2,pcdisp16

BNEZ*branch instruction***Branch on not equal to zero****BNEZ****[Mnemonic]****BNEZ Rsrc,pcdisp16****[Function]**

Branch

$$\text{if (Rsrc != 0) PC = (PC \& 0xfffffc) + ((\text{signed short}) \text{pcdisp16}) \ll 2;$$
[Description]

BNEZ causes a branch to the specified label when Rsrc is not equal to zero.

The condition bit (C) is unchanged.

[EIT occurrence]

None

[Encoding]

1011	0000	1001	src	pcdisp16
------	------	------	-----	----------

BNEZ Rsrc,pcdisp16

BRA*branch instruction*
Branch**BRA****[Mnemonic]**

- (1) **BRA** `pcdisp8`
- (2) **BRA** `pcdisp24`

[Function]

Branch

- (1) $PC = (PC \& 0xfffffc) + ((\text{signed char } pcdisp8) \ll 2);$
 - (2) $PC = (PC \& 0xfffffc) + (\text{sign_extend}(pcdisp24) \ll 2);$
- where
- ```
#define sign_extend(x) (((signed)(x) << 8) >> 8)
```

**[Description]**

BRA causes an unconditional branch to the address specified by the label.

There are two instruction formats; this allows software, such as an assembler, to decide on the better format.

The condition bit (C) is unchanged.

**[EIT occurrence]**

None

**[Encoding]**

|      |      |                       |                                  |
|------|------|-----------------------|----------------------------------|
| 0111 | 1111 | <code>pcdisp8</code>  | <b>BRA</b> <code>pcdisp8</code>  |
| 1111 | 1111 | <code>pcdisp24</code> | <b>BRA</b> <code>pcdisp24</code> |



**BSET***bit operation Instructions***Bit set****BSET****[M32R-FPU Extended Instruction]****[Mnemonic]**

```
BSET #bitpos,@(disp16,Rsrc)
```

**[Function]**

Bit operation for memory contents Set 0 to specified bit.

$$* (\text{signed char}^*) (\text{Rsrc} + (\text{signed short}) \text{disp16}) : = (1 \ll (7 - \text{bitpos}));$$
**[Description]**

BSET reads the byte data in the memory at the address specified by the Rsrc combined with the 16-bit displacement, and then stores the value of the bit that was specified by bitpos to be set to "1". The displacement is sign-extended before the address calculation. bitpos becomes 0 to 7; MSB becomes 0 and LSB becomes 7. The memory is accessed in bytes. The LOCK bit is on while the BSET instruction is executed, and is cleared when the execution is completed. The LOCK bit is internal to the CPU and cannot be directly read or written to by the user.

Condition bit C remains unchanged.

The LOCK bit is internal to the CPU and is the control bit for receiving all bus right requests from circuits other than the CPU.

Refer to the Users Manual for non-CPU bus right requests, as the handling differs according to the type of MCU.

**[EIT occurrence]**

None

**[Encoding]**

|      |   |        |      |     |        |
|------|---|--------|------|-----|--------|
| 1010 | 0 | bitpos | 0110 | src | disp16 |
|------|---|--------|------|-----|--------|

```
BSET #bitpos,@(disp16,Rsrc)
```

**BTST***bit operation Instructions***Bit test****BTST****[M32R-FPU Extended Instruction]****[Mnemonic]****BTST #bitpos,Rsrc****[Function]**

Remove the bit specified by the register.

 $C = Rsrc \gg (7 - \text{bitpos}) \& 1;$ **[Description]**

Take out the bit specified as bitpos within the Rsrc lower eight bits and sets it in the condition bit (C). bitpos becomes 0 to 7, MSB becomes 0 and LSB becomes 7.

**[EIT occurrence]**

None

**[Encoding]**

|      |   |        |      |     |
|------|---|--------|------|-----|
| 0000 | 0 | bitpos | 1111 | src |
|------|---|--------|------|-----|

**BTST #bitpos,Rsrc**

**CLRPSW***bit operation Instructions***Clear PSW****CLRPSW****[M32R-FPU Extended Instruction]****[Mnemonic]****CLRPSW #imm8****[Function]**

Set the undefined SM, IE, and C bits of PSW to 0.

PSW&amp; = ~imm8 : 0xfffff00

**[Description]**

Set the AND results of the reverse value of b0 (MSB), b1, and b7 (LSB) of the 8-bit immediate value and bits SM, IE, and C of PSW to the corresponding SM, IE, and C bits. When b7 (LSB) or #imm8 is 1, the condition bit (C) goes to 0. All other bits remain unchanged.

**[EIT occurrence]**

None

**[Encoding]**

|      |      |      |              |
|------|------|------|--------------|
| 0111 | 0010 | imm8 | CLRPSW #imm8 |
|------|------|------|--------------|

**CMP***compare instruction*  
**Compare****CMP****[Mnemonic]****CMP Rsrc1,Rsrc2****[Function]**

Compare

$$C = ((\text{signed}) Rsrc1 < (\text{signed}) Rsrc2) ? 1:0;$$
**[Description]**

The condition bit (C) is set to 1 when Rsrc1 is less than Rsrc2. The operands are treated as signed 32-bit values.

**[EIT occurrence]**

None

**[Encoding]**

|      |      |      |      |
|------|------|------|------|
| 0000 | src1 | 0100 | src2 |
|------|------|------|------|

**CMP Rsrc1,Rsrc2**

**CMPI**

*compare instruction*  
**Compare immediate**

**CMPI****[Mnemonic]**

```
CMPI Rsrc, #imm16
```

**[Function]**

Compare

$$C = ((\text{signed}) Rsrc < (\text{signed short}) \text{imm16}) ? 1:0;$$
**[Description]**

The condition bit (C) is set when Rsrc is less than 16-bit immediate value. The operands are treated as signed 32-bit values. The immediate value is sign-extended to 32-bit before the operation.

**[EIT occurrence]**

None

**[Encoding]**

|      |      |      |     |       |  |  |  |
|------|------|------|-----|-------|--|--|--|
| 1000 | 0000 | 0100 | src | imm16 |  |  |  |
|------|------|------|-----|-------|--|--|--|

```
CMPI Rsrc, #imm16
```

**CMPU***compare instruction*  
**Compare unsigned****CMPU****[Mnemonic]****CMPU Rsrc1,Rsrc2****[Function]**

Compare

$$C = ((\text{unsigned}) Rsrc1 < (\text{unsigned}) Rsrc2) ? 1:0;$$
**[Description]**

The condition bit (C) is set when Rsrc1 is less than Rsrc2. The operands are treated as unsigned 32-bit values.

**[EIT occurrence]**

None

**[Encoding]**

|      |      |      |      |
|------|------|------|------|
| 0000 | src1 | 0101 | src2 |
|------|------|------|------|

**CMPU Rsrc1,Rsrc2**

**CMPUI**

*compare instruction*  
**Compare unsigned immediate**

**CMPUI****[Mnemonic]**

```
CMPUI Rsrc, #imm16
```

**[Function]**

Compare

$$C = ((\text{unsigned}) Rsrc < (\text{unsigned}) ((\text{signed short}) imm16)) ? 1:0;$$
**[Description]**

The condition bit (C) is set when Rsrc is less than the 16-bit immediate value. The operands are treated as unsigned 32-bit values. The immediate value is sign-extended to 32-bit before the operation.

**[EIT occurrence]**

None

**[Encoding]**

|      |      |      |     |       |  |  |  |
|------|------|------|-----|-------|--|--|--|
| 1000 | 0000 | 0101 | src | imm16 |  |  |  |
|------|------|------|-----|-------|--|--|--|

```
CMPUI Rsrc, #imm16
```

**DIV***multiply and divide instruction***Divide****DIV****[Mnemonic]****DIV Rdest, Rsrc****[Function]**

Signed division

 $Rdest = (\text{signed}) Rdest / (\text{signed}) Rsrc;$ **[Description]**

DIV divides Rdest by Rsrc and puts the quotient in Rdest.

The operands are treated as signed 32-bit values and the result is rounded toward zero.

The condition bit (C) is unchanged.

When Rsrc is zero, Rdest is unchanged.

**[EIT occurrence]**

None

**[Encoding]**

|      |      |      |     |      |      |      |      |
|------|------|------|-----|------|------|------|------|
| 1001 | dest | 0000 | src | 0000 | 0000 | 0000 | 0000 |
|------|------|------|-----|------|------|------|------|

**DIV Rdest, Rsrc**



**DIVU***multiply and divide instruction***Divide unsigned****DIVU****[Mnemonic]****DIVU Rdest, Rsrc****[Function]**

Unsigned division

 $Rdest = (\text{unsigned}) Rdest / (\text{unsigned}) Rsrc;$ **[Description]**

DIVU divides Rdest by Rsrc and puts the quotient in Rdest.

The operands are treated as unsigned 32-bit values and the result is rounded toward zero.

The condition bit (C) is unchanged.

When Rsrc is zero, Rdest is unchanged.

**[EIT occurrence]**

None

**[Encoding]**

|      |      |      |     |      |      |      |      |
|------|------|------|-----|------|------|------|------|
| 1001 | dest | 0001 | src | 0000 | 0000 | 0000 | 0000 |
|------|------|------|-----|------|------|------|------|

**DIVU Rdest, Rsrc**

**FADD***floating-point Instructions***Floating-point add****[M32R-FPU Extended Instruction]****FADD****[Mnemonic]****FADD Rdest, Rsrc1, Rsrc2****[Function]**

Floating-point add

Rdest = Rsrc1 + Rsrc2 ;

**[Description]**

Add the floating-point single precision values stored in Rsrc1 and Rsrc2 and store the result in Rdest. The result is rounded according to the RM field of FPSR. The DN bit of FPSR handles the modification of denormalized numbers. The condition bit (C) remains unchanged.

**[EIT occurrence]**

Floating-Point Exceptions (FPE)

- Unimplemented Operation Exception (UIPL)
- Invalid Operation Exception (IVLD)
- Overflow (OVF)
- Underflow (UDF)
- Inexact Exception (IXCT)

**[Encoding]**

|      |      |      |      |      |      |      |      |
|------|------|------|------|------|------|------|------|
| 1101 | src1 | 0000 | src2 | 0000 | dest | 0000 | 0000 |
|------|------|------|------|------|------|------|------|

**FADD Rdest, Rsrc1, Rsrc2**

## FADD

*floating point Instructions*

## FADD

Floating-point add

[M32R-FPU Extended Instruction]

**[Supplemental Operation Description]**

The following shows the values of Rsrc1 and Rsrc2 and the operation results when DN = 0 and DN = 1.

**DN = 0**

|       |                     | Rsrc2             |    |        |           |           |                     |      |      |  |  |  |
|-------|---------------------|-------------------|----|--------|-----------|-----------|---------------------|------|------|--|--|--|
|       |                     | Normalized Number | +0 | -0     | +Infinity | -Infinity | Denormalized Number | QNaN | SNaN |  |  |  |
| Rsrc1 | Normalized Number   | add               |    | (Note) | -Infinity | UIPL      | QNaN                | SNaN |      |  |  |  |
|       | +0                  | +0                |    |        |           |           |                     |      |      |  |  |  |
|       | -0                  | (Note)            | -0 |        |           |           |                     |      |      |  |  |  |
|       | +Infinity           | +Infinity         |    | IVLD   |           |           |                     |      |      |  |  |  |
|       | -Infinity           | -Infinity         |    | IVLD   | -Infinity |           |                     |      |      |  |  |  |
|       | Denormalized Number |                   |    |        |           |           |                     |      |      |  |  |  |
|       | QNaN                |                   |    |        |           |           |                     |      |      |  |  |  |
|       | SNaN                |                   |    |        |           |           |                     |      |      |  |  |  |

**DN = 1**

|       |                                 | Rsrc2             |                                 |                                 |           |           |      |      |  |  |
|-------|---------------------------------|-------------------|---------------------------------|---------------------------------|-----------|-----------|------|------|--|--|
|       |                                 | Normalized Number | +0, +<br>Denormalized<br>Number | -0, -<br>Denormalized<br>Number | +Infinity | -Infinity | QNaN | SNaN |  |  |
| Rsrc1 | Normalized Number               | add               | Normalized Number               |                                 | -Infinity | QNaN      | SNaN |      |  |  |
|       | +0, +<br>Denormalized<br>Number | Normalized Number | +0                              | (Note)                          |           |           |      |      |  |  |
|       | -0, -<br>Denormalized<br>Number |                   | (Note)                          | -0                              |           |           |      |      |  |  |
|       | +Infinity                       | +Infinity         |                                 | IVLD                            |           |           |      |      |  |  |
|       | -Infinity                       | -Infinity         |                                 | IVLD                            | -Infinity |           |      |      |  |  |
|       | QNaN                            |                   |                                 |                                 |           |           |      |      |  |  |
|       | SNaN                            |                   |                                 |                                 |           |           |      |      |  |  |

IVLD: Invalid Operation Exception

UIPL: Unimplemented Exception

NaN: Not a Number

SNaN: Signaling NaN

QNaN: Quiet NaN

Note: The rounding mode is “-0” when rounding toward “-Infinity”, and “+0” when rounding toward any other direction.

**FCMP**

*floating point Instructions*  
**Floating-point compare**  
**[M32R-FPU Extended Instruction]**

**FCMP****[Mnemonic]**

**FCMP Rdest, Rsrc1, Rsrc2**

**[Function]**

Floating-point compare

Rdest = (comparison results of Rsrc1 and Rsrc2);

When at least one value, either Rsrc1 or Rsrc2, is SNaN, a floating-point exception (other than Invalid Operation Exception) occurs.

**[Description]**

Compare the floating-point single precision values stored in Rsrc1 and Rsrc2 and store the result in Rdest. The results of the comparison can be determined by the following methods.

| Rdest |                                                            | Comparison Results | Typical instructions used to determine comparison results |
|-------|------------------------------------------------------------|--------------------|-----------------------------------------------------------|
| b0=0  | All bits, b1 to b31, are 0.                                | Rsrc1=Rsrc2        | beqz Rdest, LABEL                                         |
|       | b1 to b9=111 1111 11,<br>Bits b10 to b31 are an undefined. | Comparison invalid | bgtz Rdest, LABEL                                         |
|       | All others                                                 | Rsrc1>Rsrc2        |                                                           |
| b0=1  | Bits b1 to b31 are an undefined.                           | Rsrc1<Rsrc2        | bltz Rdest, LABEL                                         |

The DN bit of FPSR handles the conversion of denormalized numbers. The condition bit (C) remains unchanged.

**[EIT occurrence]**

Floating-Point Exceptions (FPE)

- Unimplemented Operation Exception (UIPL)
- Invalid Operation Exception (IVLD)

**[Encoding]**

|      |      |      |      |      |      |      |      |
|------|------|------|------|------|------|------|------|
| 1101 | src1 | 0000 | src2 | 0000 | dest | 1100 | 0000 |
|------|------|------|------|------|------|------|------|

**FCMP Rdest, Rsrc1, Rsrc2**

## FCMP

*floating point Instructions*  
 Floating-point compare  
 [M32R-FPU Extended Instruction]

## FCMP

**[Supplemental Operation Description]**

The following shows the values of Rsrc1 and Rsrc2 and the operation results when DN = 0 and DN = 1.

**DN = 0**

|       |                     | Rsrc2             |    |          |           |           |                     |                    |      |  |  |
|-------|---------------------|-------------------|----|----------|-----------|-----------|---------------------|--------------------|------|--|--|
|       |                     | Normalized Number | +0 | -0       | +Infinity | -Infinity | Denormalized Number | QNaN               | SNaN |  |  |
| Rsrc1 | Normalized Number   | comparison        |    |          | -Infinity | +Infinity | UIPL                | comparison invalid | IVLD |  |  |
|       | +0                  | 00000000          |    |          |           |           |                     |                    |      |  |  |
|       | -0                  |                   |    |          |           |           |                     |                    |      |  |  |
|       | +Infinity           | +Infinity         |    | 00000000 |           |           |                     |                    |      |  |  |
|       | -Infinity           | -Infinity         |    |          | 00000000  |           |                     |                    |      |  |  |
|       | Denormalized Number |                   |    |          |           |           |                     |                    |      |  |  |
|       | QNaN                |                   |    |          |           |           |                     |                    |      |  |  |
| SNaN  |                     |                   |    |          |           |           |                     |                    |      |  |  |

**DN = 1**

|       |                          | Rsrc2             |                          |                          |           |           |                    |      |
|-------|--------------------------|-------------------|--------------------------|--------------------------|-----------|-----------|--------------------|------|
|       |                          | Normalized Number | +0, +Denormalized Number | -0, -Denormalized Number | +Infinity | -Infinity | QNaN               | SNaN |
| Rsrc1 | Normalized Number        | comparison        |                          |                          | -Infinity | +Infinity | comparison invalid | IVLD |
|       | +0, +Denormalized Number | 00000000          |                          |                          |           |           |                    |      |
|       | -0, -Denormalized Number |                   |                          |                          |           |           |                    |      |
|       | +Infinity                | +Infinity         |                          | 00000000                 |           |           |                    |      |
|       | -Infinity                | -Infinity         |                          |                          | 00000000  |           |                    |      |
|       | QNaN                     |                   |                          |                          |           |           |                    |      |
| SNaN  |                          |                   |                          |                          |           |           |                    |      |

IVLD: Invalid Operation Exception

UIPL: Unimplemented Exception

NaN: Not a Number

SNaN: Signaling NaN

QNaN: Quiet NaN

# FCMPE *floating-point Instructions* FCMPE

## Floating-point compare with exception if unordered [M32R-FPU Extended Instruction]

**[Mnemonic]**

**FCMPE** *Rdest, Rsrc1, Rsrc2*

**[Function]**

Floating-point compare

Rdest = (comparison results of Rsrc1 and Rsrc2);

When at least one value, either Rsrc1 or Rsrc2, is QNaN or SNaN, a floating-point exception (other than Invalid Operation Exception) occurs.

**[Description]**

Compare the floating-point single precision values stored in Rsrc1 and Rsrc2 and store the result in Rdest. The results of the comparison can be determined by the following methods.

| Rdest |                                                                      | Comparison Results | Typical instructions used to determine comparison results |
|-------|----------------------------------------------------------------------|--------------------|-----------------------------------------------------------|
| b0=0  | All bits, b1 to b31, are 0.                                          | Rsrc1=Rsrc2        | beqz Rdest, LABEL                                         |
|       | b1 to b9=111 1111 11,<br>Bits b10 to b31 are an undefined.<br>(Note) | Comparison invalid | bgtz Rdest, LABEL                                         |
|       | All others                                                           | Rsrc1>Rsrc2        |                                                           |
| b0=1  | Bits b1 to b31 are an undefined.                                     | Rsrc1<Rsrc2        | bltz Rdest, LABEL                                         |

Note: Only when EV bit (b21 of FPSR Register) = "0".

The DN bit of FPSR handles the conversion of denormalized numbers. The condition bit (C) remains unchanged.

**[EIT occurrence]**

Floating-Point Exceptions (FPE)

- Unimplemented Operation Exception (UIPL)
- Invalid Operation Exception (IVLD)

**[Encoding]**

|      |             |      |             |      |             |      |      |
|------|-------------|------|-------------|------|-------------|------|------|
| 1101 | <i>src1</i> | 0000 | <i>src2</i> | 0000 | <i>dest</i> | 1101 | 0000 |
|------|-------------|------|-------------|------|-------------|------|------|

**FCMPE** *Rdest, Rsrc1, Rsrc2*

## FCMPE

*floating point Instructions*

## FCMPE

Floating-point compare with exception  
if unordered  
[M32R-FPU Extended Instruction]

**[Supplemental Operation Description]**

The following shows the values of Rsrc1 and Rsrc2 and the operation results when DN = 0 and DN = 1.

**DN = 0**

|       |                     | Rsrc2             |    |          |           |           |                     |      |      |  |  |
|-------|---------------------|-------------------|----|----------|-----------|-----------|---------------------|------|------|--|--|
|       |                     | Normalized Number | +0 | -0       | +Infinity | -Infinity | Denormalized Number | QNaN | SNaN |  |  |
| Rsrc1 | Normalized Number   | comparison        |    |          | -Infinity | +Infinity | UIPL                | IVLD |      |  |  |
|       | +0                  | 00000000          |    |          |           |           |                     |      |      |  |  |
|       | -0                  |                   |    |          |           |           |                     |      |      |  |  |
|       | +Infinity           | +Infinity         |    | 00000000 |           |           |                     |      |      |  |  |
|       | -Infinity           | -Infinity         |    |          | 00000000  |           |                     |      |      |  |  |
|       | Denormalized Number |                   |    |          |           |           |                     |      |      |  |  |
|       | QNaN                |                   |    |          |           |           |                     |      |      |  |  |
| SNaN  |                     |                   |    |          |           |           |                     |      |      |  |  |

**DN = 1**

|       |                           | Rsrc2             |                           |                           |           |           |      |      |
|-------|---------------------------|-------------------|---------------------------|---------------------------|-----------|-----------|------|------|
|       |                           | Normalized Number | +0, + Denormalized Number | -0, - Denormalized Number | +Infinity | -Infinity | QNaN | SNaN |
| Rsrc1 | Normalized Number         | comparison        |                           |                           | -Infinity | +Infinity | IVLD |      |
|       | +0, + Denormalized Number | 00000000          |                           |                           |           |           |      |      |
|       | -0, - Denormalized Number |                   |                           |                           |           |           |      |      |
|       | +Infinity                 | +Infinity         |                           | 00000000                  |           |           |      |      |
|       | -Infinity                 | -Infinity         |                           |                           | 00000000  |           |      |      |
|       | QNaN                      |                   |                           |                           |           |           |      |      |
| SNaN  |                           |                   |                           |                           |           |           |      |      |

IVLD: Invalid Operation Exception

UIPL: Unimplemented Exception

NaN: Not a Number

SNaN: Signaling NaN

QNaN: Quiet NaN

**FDIV**

*floating-point Instructions*  
**Floating-point divide**  
**[M32R-FPU Extended Instruction]**

**FDIV****[Mnemonic]**

**FDIV** *Rdest, Rsrc1, Rsrc2*

**[Function]**

Floating-point divide  
 $Rdest = Rsrc1 / Rsrc2 ;$

**[Description]**

Divide the floating-point single precision value stored in Rsrc1 by the floating-point single precision value stored in Rsrc1 and store the result in Rdest. The result is rounded according to the RM field of FPSR. The DN bit of FPSR handles the modification of denormalized numbers. The condition bit (C) remains unchanged.

**[EIT occurrence]**

- Floating-Point Exceptions (FPE)
- Unimplemented Operation Exception (UIPL)
  - Invalid Operation Exception (IVLD)
  - Overflow (OVF)
  - Underflow (UDF)
  - Inexact Exception (IXCT)
  - Zero Divide Exception (DIV0)

**[Encoding]**

|      |             |      |             |      |             |      |      |
|------|-------------|------|-------------|------|-------------|------|------|
| 1101 | <i>src1</i> | 0000 | <i>src2</i> | 0010 | <i>dest</i> | 0000 | 0000 |
|------|-------------|------|-------------|------|-------------|------|------|

**FDIV** *Rdest, Rsrc1, Rsrc2*



## FDIV

*floating point Instructions*

## FDIV

Floating-point divide

[M32R-FPU Extended Instruction]

**[Supplemental Operation Description]**

The following shows the values of Rsrc1 and Rsrc2 and the operation results when DN = 0 and DN = 1.

**DN = 0**

|       |                     | Rsrc2             |           |           |           |           |                     |      |      |  |  |
|-------|---------------------|-------------------|-----------|-----------|-----------|-----------|---------------------|------|------|--|--|
|       |                     | Normalized Number | +0        | -0        | +Infinity | -Infinity | Denormalized Number | QNaN | SNaN |  |  |
| Rsrc1 | Normalized Number   | divide            | DIV0      |           | 0         |           | UIPL                | QNaN | IVLD |  |  |
|       | +0                  | 0                 | IVLD      |           | +0        | -0        |                     |      |      |  |  |
|       | -0                  |                   |           |           | -0        | +0        |                     |      |      |  |  |
|       | +Infinity           | Infinity          | +Infinity | -Infinity | IVLD      |           |                     |      |      |  |  |
|       | -Infinity           |                   | -Infinity | +Infinity |           |           |                     |      |      |  |  |
|       | Denormalized Number | UIPL              |           |           |           |           |                     |      |      |  |  |
|       | QNaN                | QNaN              |           |           |           |           |                     |      |      |  |  |
| SNaN  | IVLD                |                   |           |           |           |           |                     |      |      |  |  |

**DN = 1**

|       |                          | Rsrc2             |                          |                          |           |           |      |      |  |  |
|-------|--------------------------|-------------------|--------------------------|--------------------------|-----------|-----------|------|------|--|--|
|       |                          | Normalized Number | +0, +Denormalized Number | -0, -Denormalized Number | +Infinity | -Infinity | QNaN | SNaN |  |  |
| Rsrc1 | Normalized Number        | divide            | DIV0                     |                          | 0         |           | QNaN | IVLD |  |  |
|       | +0, +Denormalized Number | 0                 | IVLD                     |                          | +0        | -0        |      |      |  |  |
|       | -0, -Denormalized Number |                   |                          |                          | -0        | +0        |      |      |  |  |
|       | +Infinity                | Infinity          | +Infinity                | -Infinity                | IVLD      |           |      |      |  |  |
|       | -Infinity                |                   | -Infinity                | +Infinity                |           |           |      |      |  |  |
|       | QNaN                     | QNaN              |                          |                          |           |           |      |      |  |  |
|       | SNaN                     | IVLD              |                          |                          |           |           |      |      |  |  |

IVLD: Invalid Operation Exception

UIPL: Unimplemented Exception

DIV0: Zero Divide Exception

NaN: Not a Number

SNaN: Signaling NaN

QNaN: Quiet NaN

**FMADD***floating-point Instructions***Floating-point multiply and add  
[M32R-FPU Extended Instruction]****FMADD****[Mnemonic]****FMADD Rdest, Rsrc1, Rsrc2****[Function]**

Floating-point multiply and add

 $Rdest = Rdest + Rsrc1 * Rsrc2 ;$ **[Description]**

This instruction is executed in the following 2 steps.

## ● Step 1

Multiply the floating-point single precision value stored in Rsrc1 by the floating-point single precision value stored in Rsrc2.

The multiplication result is rounded toward 0 regardless of the value in the RM field of FPSR.

## ● Step 2

Add the result of Step 1 (the rounded value) and the floating-point single precision value stored in Rdest. The result is rounded according to the RM field of FPSR.

The result of this operation is stored in Rdest. Exceptions are determined in both Step 1 and Step 2. The DN bit of FPSR handles the conversion of denormalized numbers. The condition bit (C) remains unchanged.

**[EIT occurrence]**

Floating-Point Exceptions (FPE)

- Unimplemented Operation Exception (UIPL)
- Invalid Operation Exception (IVLD)
- Overflow (OVF)
- Underflow (UDF)
- Inexact Exception (IXCT)

**[Encoding]**

|      |      |      |      |      |      |      |      |
|------|------|------|------|------|------|------|------|
| 1101 | src1 | 0000 | src2 | 0011 | dest | 0000 | 0000 |
|------|------|------|------|------|------|------|------|

**FMADD Rdest, Rsrc1, Rsrc2**

## FMADD

*floating point Instructions*

## FMADD

Floating-point multiply and add  
[M32R-FPU Extended Instruction]

**[Supplemental Operation Description]**

The following shows the values of Rsrc1, Rsrc2 and Rdest and the operation results when DN = 0 and DN = 1.

**DN=0****Value after Multiplication Operation**

|       |                     | Rsrc2             |      |      |           |           |                     |      |      |  |
|-------|---------------------|-------------------|------|------|-----------|-----------|---------------------|------|------|--|
|       |                     | Normalized Number | +0   | -0   | +Infinity | -Infinity | Denormalized Number | QNaN | SNaN |  |
| Rsrc1 | Normalized Number   | Multiplication    |      |      | Infinity  |           | UIPL                | QNaN | IVLD |  |
|       | +0                  |                   |      | IVLD |           |           |                     |      |      |  |
|       | -0                  |                   |      |      |           |           |                     |      |      |  |
|       | +Infinity           | Infinity          | IVLD |      | +Infinity | -Infinity |                     |      |      |  |
|       | -Infinity           |                   |      |      | -Infinity | +Infinity |                     |      |      |  |
|       | Denormalized Number | UIPL              |      |      |           |           |                     |      |      |  |
|       | QNaN                | QNaN              |      |      |           |           |                     |      |      |  |
|       | SNaN                | IVLD              |      |      |           |           |                     |      |      |  |

**Value after Addition Operation**

|       |                     | Value after Multiplication Operation |    |           |           |           |           |
|-------|---------------------|--------------------------------------|----|-----------|-----------|-----------|-----------|
|       |                     | Normalized Number                    | +0 | -0        | +Infinity | -Infinity | QNaN      |
| Rdest | Normalized Number   | add                                  |    |           |           | QNaN      |           |
|       | +0                  |                                      |    | -Infinity |           |           |           |
|       | -0                  |                                      |    |           |           |           |           |
|       | +Infinity           |                                      |    |           | +Infinity |           | IVLD      |
|       | -Infinity           | -Infinity                            |    |           | IVLD      |           | -Infinity |
|       | Denormalized Number | UIPL                                 |    |           |           |           |           |
|       | QNaN                | QNaN                                 |    |           |           |           |           |
|       | SNaN                | IVLD                                 |    |           |           |           |           |

IVLD: Invalid Operation Exception

UIPL: Unimplemented Exception

NaN: Not a Number

SNaN: Signaling NaN

QNaN: Quiet NaN

Note: The rounding mode is “-0” when rounding toward “-Infinity”, and “+0” when rounding toward any other direction.

## FMADD

*floating point Instructions*

## FMADD

Floating-point multiply and add  
[M32R-FPU Extended Instruction]

DN=1

## Value after Multiplication Operation

|       |                           | Rsrc2             |                           |                           |           |           |      |      |  |
|-------|---------------------------|-------------------|---------------------------|---------------------------|-----------|-----------|------|------|--|
|       |                           | Normalized Number | +0, + Denormalized Number | -0, - Denormalized Number | +Infinity | -Infinity | QNaN | SNaN |  |
| Rsrc1 | Normalized Number         | Multiplication    |                           |                           | Infinity  |           | QNaN | SNaN |  |
|       | +0, + Denormalized Number |                   | +0                        | -0                        | IVLD      |           |      |      |  |
|       | -0, - Denormalized Number |                   | -0                        | +0                        | IVLD      |           |      |      |  |
|       | +Infinity                 | Infinity          | IVLD                      |                           | +Infinity | -Infinity |      |      |  |
|       | -Infinity                 | Infinity          | IVLD                      |                           | -Infinity | +Infinity |      |      |  |
|       | QNaN                      | QNaN              |                           |                           |           |           |      |      |  |
|       | SNaN                      | IVLD              |                           |                           |           |           |      |      |  |

## Value after Addition Operation

|       |                   | Value after Multiplication Operation |        |        |           |           |      |           |
|-------|-------------------|--------------------------------------|--------|--------|-----------|-----------|------|-----------|
|       |                   | Normalized Number                    | +0     | -0     | +Infinity | -Infinity | QNaN |           |
| Rdest | Normalized Number | Multiplication                       |        |        | +Infinity | -Infinity | QNaN |           |
|       | +0                |                                      | +0     | (Note) |           |           |      | -Infinity |
|       | -0                |                                      | (Note) | -0     |           |           |      | -Infinity |
|       | +Infinity         | +Infinity                            |        |        | IVLD      |           |      |           |
|       | -Infinity         | -Infinity                            |        |        | IVLD      | -Infinity |      |           |
|       | QNaN              | QNaN                                 |        |        |           |           |      |           |
|       | SNaN              | IVLD                                 |        |        |           |           |      |           |

IVLD: Invalid Operation Exception

UIPL: Unimplemented Exception

NaN: Not a Number

SNaN: Signaling NaN

QNaN: Quiet NaN

Note: The rounding mode is “-0” when rounding toward “-Infinity”, and “+0” when rounding toward any other direction.

**FMSUB***floating-point Instructions***Floating-point multiply and subtract****[M32R-FPU Extended Instruction]****FMSUB****[Mnemonic]****FMSUB Rdest, Rsrc1, Rsrc2****[Function]**

Floating-point multiply and subtract

 $Rdest = Rdest - Rsrc1 * Rsrc2 ;$ **[Description]**

This instruction is executed in the following 2 steps.

## ● Step 1

Multiply the floating-point single precision value stored in Rsrc1 by the floating-point single precision value stored in Rsrc2.

The multiplication result is rounded toward 0 regardless of the value in the RM field of FPSR.

## ● Step 2

Subtract the result (rounded value) of Step 1 from the floating-point single precision value stored in Rdest.

The subtraction result is rounded according to the RM field of FPSR.

The result of this operation is stored in Rdest. Exceptions are determined in both Step 1 and Step 2. The DN bit of FPSR handles the conversion of denormalized numbers. The condition bit (C) remains unchanged.

**[EIT occurrence]**

Floating-Point Exceptions (FPE)

- Unimplemented Operation Exception (UIPL)
- Invalid Operation Exception (IVLD)
- Overflow (OVF)
- Underflow (UDF)
- Inexact Exception (IXCT)

**[Encoding]**

|      |      |      |      |      |      |      |      |
|------|------|------|------|------|------|------|------|
| 1101 | src1 | 0000 | src2 | 0011 | dest | 0100 | 0000 |
|------|------|------|------|------|------|------|------|

**FMSUB Rdest, Rsrc1, Rsrc2**

FMSUB

*floating point Instructions*  
 Floating-point multiply and subtract  
 [M32R-FPU Extended Instruction]

FMSUB

**[Supplemental Operation Description]**

The following shows the values of Rsrc1, Rsrc2 and Rdest and the operation results when DN = 0 and DN = 1.

**DN=0**

**Value after Multiplication Operation**

|       |                     | Rsrc2             |      |    |           |           |                     |      |      |  |
|-------|---------------------|-------------------|------|----|-----------|-----------|---------------------|------|------|--|
|       |                     | Normalized Number | +0   | -0 | +Infinity | -Infinity | Denormalized Number | QNaN | SNaN |  |
| Rsrc1 | Normalized Number   | Multiplication    |      |    | Infinity  |           | UIPL                | QNaN | IVLD |  |
|       | +0                  |                   | +0   | -0 | IVLD      |           |                     |      |      |  |
|       | -0                  |                   | -0   | +0 |           |           |                     |      |      |  |
|       | +Infinity           | Infinity          | IVLD |    | +Infinity | -Infinity |                     |      |      |  |
|       | -Infinity           |                   |      |    | -Infinity | +Infinity |                     |      |      |  |
|       | Denormalized Number | UIPL              |      |    |           |           |                     |      |      |  |
|       | QNaN                | QNaN              |      |    |           |           |                     |      |      |  |
|       | SNaN                | IVLD              |      |    |           |           |                     |      |      |  |

**Value after Subtraction Operation**

|       |                     | Value after Multiplication Operation |        |        |           |           |      |  |
|-------|---------------------|--------------------------------------|--------|--------|-----------|-----------|------|--|
|       |                     | Normalized Number                    | +0     | -0     | +Infinity | -Infinity | QNaN |  |
| Rdest | Normalized Number   | Subtraction                          |        |        |           | -Infinity | QNaN |  |
|       | +0                  |                                      | +0     | (Note) |           |           |      |  |
|       | -0                  |                                      | (Note) | -0     |           |           |      |  |
|       | +Infinity           |                                      |        |        | +Infinity | IVLD      |      |  |
|       | -Infinity           | -Infinity                            |        |        | IVLD      | -Infinity |      |  |
|       | Denormalized Number | UIPL                                 |        |        |           |           |      |  |
|       | QNaN                | QNaN                                 |        |        |           |           |      |  |
|       | SNaN                | IVLD                                 |        |        |           |           |      |  |

- IVLD: Invalid Operation Exception
- UIPL: Unimplemented Exception
- NaN: Not a Number
- SNaN: Signaling NaN
- QNaN: Quiet NaN

Note: The rounding mode is “-0” when rounding toward “-Infinity”, and “+0” when rounding toward any other direction.

## FMSUB

*floating point Instructions*

## FMSUB

Floating-point multiply and subtract  
[M32R-FPU Extended Instruction]

DN=1

## Value after Multiplication Operation

|       |                           | Rsrc2             |                           |                           |           |           |      |      |  |
|-------|---------------------------|-------------------|---------------------------|---------------------------|-----------|-----------|------|------|--|
|       |                           | Normalized Number | +0, + Denormalized Number | -0, - Denormalized Number | +Infinity | -Infinity | QNaN | SNaN |  |
| Rsrc1 | Normalized Number         | Multiplication    |                           |                           | Infinity  |           | QNaN | IVLD |  |
|       | +0, + Denormalized Number | +0                |                           | -0                        |           | IVLD      |      |      |  |
|       | -0, - Denormalized Number | -0                |                           | +0                        |           |           |      |      |  |
|       | +Infinity                 | Infinity          | IVLD                      |                           | +Infinity | -Infinity |      |      |  |
|       | -Infinity                 |                   | IVLD                      |                           | -Infinity | +Infinity |      |      |  |
|       | QNaN                      | QNaN              |                           |                           |           |           |      |      |  |
|       | SNaN                      | IVLD              |                           |                           |           |           |      |      |  |

## Value after Subtraction Operation

|       |                   | Value after Multiplication Operation |    |        |           |           |      |
|-------|-------------------|--------------------------------------|----|--------|-----------|-----------|------|
|       |                   | Normalized Number                    | +0 | -0     | +Infinity | -Infinity | QNaN |
| Rdest | Normalized Number | Subtraction                          |    |        | -Infinity | +Infinity | QNaN |
|       | +0                | (Note)                               |    | +0     |           |           |      |
|       | -0                | -0                                   |    | (Note) |           |           |      |
|       | +Infinity         | +Infinity                            |    |        | IVLD      |           |      |
|       | -Infinity         | -Infinity                            |    |        | IVLD      |           |      |
|       | QNaN              | QNaN                                 |    |        |           |           |      |
|       | SNaN              | IVLD                                 |    |        |           |           |      |

IVLD: Invalid Operation Exception

UIPL: Unimplemented Exception

NaN: Not a Number

SNaN: Signaling NaN

QNaN: Quiet NaN

Note: The rounding mode is “-0” when rounding toward “-Infinity”, and “+0” when rounding toward any other direction.

**FMUL**

*floating-point Instructions*  
**Floating-point multiply**  
**[M32R-FPU Extended Instruction]**

**FMUL****[Mnemonic]**

**FMUL** *Rdest, Rsrc1, Rsrc2*

**[Function]**

Floating-point multiply  
 $Rdest = Rsrc1 * Rsrc2 ;$

**[Description]**

Multiply the floating-point single precision value stored in Rsrc1 by the floating-point single precision value stored in Rsrc2 and store the results in Rdest. The result is rounded according to the RM field of FPSR. The DN bit of FPSR handles the modification of denormalized numbers. The condition bit (C) remains unchanged.

**[EIT occurrence]**

- Floating-Point Exceptions (FPE)
- Unimplemented Operation Exception (UIPL)
  - Invalid Operation Exception (IVLD)
  - Overflow (OVF)
  - Underflow (UDF)
  - Inexact Exception (IXCT)

**[Encoding]**

|      |             |      |             |      |             |      |      |
|------|-------------|------|-------------|------|-------------|------|------|
| 1101 | <i>src1</i> | 0000 | <i>src2</i> | 0001 | <i>dest</i> | 0000 | 0000 |
|------|-------------|------|-------------|------|-------------|------|------|

**FMUL** *Rdest, Rsrc1, Rsrc2*



## FMUL

*floating point Instructions*  
 Floating-point multiply  
 [M32R-FPU Extended Instruction]

## FMUL

**[Supplemental Operation Description]**

The following shows the values of Rsrc1 and Rsrc2 and the operation results when DN = 0 and DN = 1.

**DN=0**

|       |                     | Rsrc2             |      |      |           |           |                     |      |      |    |
|-------|---------------------|-------------------|------|------|-----------|-----------|---------------------|------|------|----|
|       |                     | Normalized Number | +0   | -0   | +Infinity | -Infinity | Denormalized Number | QNaN | SNaN |    |
| Rsrc1 | Normalized Number   | Multiplication    |      |      | Infinity  |           | UIPL                | QNaN | IVLD |    |
|       | +0                  | +0                | -0   | IVLD |           |           |                     |      |      |    |
|       | -0                  |                   |      |      |           | -0        |                     |      |      | +0 |
|       | +Infinity           | Infinity          | IVLD |      | +Infinity |           |                     |      |      |    |
|       | -Infinity           |                   |      |      | -Infinity | +Infinity |                     |      |      |    |
|       | Denormalized Number | UIPL              |      |      |           |           |                     |      |      |    |
|       | QNaN                | QNaN              |      |      |           |           |                     |      |      |    |
| SNaN  | IVLD                |                   |      |      |           |           |                     |      |      |    |

**DN=1**

|       |                           | Rsrc2             |                           |                           |           |           |      |      |    |
|-------|---------------------------|-------------------|---------------------------|---------------------------|-----------|-----------|------|------|----|
|       |                           | Normalized Number | +0, + Denormalized Number | -0, - Denormalized Number | +Infinity | -Infinity | QNaN | SNaN |    |
| Rsrc1 | Normalized Number         | Multiplication    |                           |                           | Infinity  |           | QNaN | IVLD |    |
|       | +0, + Denormalized Number | +0                | -0                        | IVLD                      |           |           |      |      |    |
|       | -0, - Denormalized Number |                   |                           |                           |           | -0        |      |      | +0 |
|       | +Infinity                 | Infinity          | IVLD                      |                           | +Infinity |           |      |      |    |
|       | -Infinity                 |                   |                           |                           | -Infinity | +Infinity |      |      |    |
|       | QNaN                      | QNaN              |                           |                           |           |           |      |      |    |
|       | SNaN                      | IVLD              |                           |                           |           |           |      |      |    |

IVLD: Invalid Operation Exception

UIPL: Unimplemented Exception

NaN: Not a Number

SNaN: Signaling NaN

QNaN: Quiet NaN

**FSUB**

*floating-point Instructions*  
**Floating-point subtract**  
**[M32R-FPU Extended Instruction]**

**FSUB****[Mnemonic]**

**FSUB Rdest, Rsrc1, Rsrc2**

**[Function]**

Floating-point subtract

Rdest = Rsrc1 - Rsrc2 ;

**[Description]**

Subtract the floating-point single precision value stored in Rsrc2 from the floating-point single precision value stored in Rsrc1 and store the results in Rdest. The result is rounded according to the RM field of FPSR. The DN bit of FPSR handles the modification of denormalized numbers. The condition bit (C) remains unchanged.

**[EIT occurrence]**

Floating-Point Exceptions (FPE)

- Unimplemented Operation Exception (UIPL)
- Invalid Operation Exception (IVLD)
- Overflow (OVF)
- Underflow (UDF)
- Inexact Exception (IXCT)

**[Encoding]**

|      |      |      |      |      |      |      |      |
|------|------|------|------|------|------|------|------|
| 1101 | src1 | 0000 | src2 | 0000 | dest | 0100 | 0000 |
|------|------|------|------|------|------|------|------|

**FSUB Rdest, Rsrc1, Rsrc2**

## FSUB

*floating point Instructions*  
 Floating-point subtract  
 [M32R-FPU Extended Instruction]

## FSUB

**[Supplemental Operation Description]**

The following shows the values of Rsrc1 and Rsrc2 and the operation results when DN = 0 and DN = 1.

**DN = 0**

|       |                     | Rsrc2             |        |      |           |           |                     |      |      |  |  |
|-------|---------------------|-------------------|--------|------|-----------|-----------|---------------------|------|------|--|--|
|       |                     | Normalized Number | +0     | -0   | +Infinity | -Infinity | Denormalized Number | QNaN | SNaN |  |  |
| Rsrc1 | Normalized Number   | Subtraction       |        |      | -Infinity | +Infinity | UIPL                | QNaN | IVLD |  |  |
|       | +0                  | (Note)            | +0     |      |           |           |                     |      |      |  |  |
|       | -0                  | -0                | (Note) |      |           |           |                     |      |      |  |  |
|       | +Infinity           | +Infinity         |        | IVLD |           |           |                     |      |      |  |  |
|       | -Infinity           | -Infinity         |        | IVLD |           |           |                     |      |      |  |  |
|       | Denormalized Number | UIPL              |        |      |           |           |                     |      |      |  |  |
|       | QNaN                | QNaN              |        |      |           |           |                     |      |      |  |  |
| SNaN  | IVLD                |                   |        |      |           |           |                     |      |      |  |  |

**DN = 1**

|       |                           | Rsrc2             |                           |                           |           |           |      |      |  |  |
|-------|---------------------------|-------------------|---------------------------|---------------------------|-----------|-----------|------|------|--|--|
|       |                           | Normalized Number | +0, + Denormalized Number | -0, - Denormalized Number | +Infinity | -Infinity | QNaN | SNaN |  |  |
| Rsrc1 | Normalized Number         | Subtraction       |                           |                           | -Infinity | +Infinity | QNaN | IVLD |  |  |
|       | +0, + Denormalized Number | (Note)            | +0                        |                           |           |           |      |      |  |  |
|       | -0, - Denormalized Number | -0                | (Note)                    |                           |           |           |      |      |  |  |
|       | +Infinity                 | +Infinity         |                           | IVLD                      |           |           |      |      |  |  |
|       | -Infinity                 | -Infinity         |                           | IVLD                      |           |           |      |      |  |  |
|       | QNaN                      | QNaN              |                           |                           |           |           |      |      |  |  |
|       | SNaN                      | IVLD              |                           |                           |           |           |      |      |  |  |

IVLD: Invalid Operation Exception

UIPL: Unimplemented Exception

NaN: Not a Number

SNaN: Signaling NaN

QNaN: Quiet NaN

Note: The rounding mode is “-0” when rounding toward “-Infinity”, and “+0” when rounding toward any other direction.

**FTOI***floating-point Instructions***FTOI****Float to Integer****[M32R-FPU Extended Instruction]****[Mnemonic]****FTOI Rdest, Rsrc****[Function]**

Convert the floating-point single precision value to 32-bit integer.

Rdest = (signed int) Rsrc ;

**[Description]**

Convert the floating-point single precision value stored in Rsrc to a 32-bit integer and store the result in Rdest.

The result is rounded toward 0 regardless of the value in the RM field of FPSR. The condition bit (C) remains unchanged.

**[EIT occurrence]**

Floating-Point Exceptions (FPE)

- Unimplemented Operation Exception (UIPL)
- Invalid Operation Exception (IVLD)
- Inexact Exception (IXCT)

**[Encoding]**

|      |     |      |      |      |      |      |      |
|------|-----|------|------|------|------|------|------|
| 1101 | src | 0000 | 0000 | 0100 | dest | 1000 | 0000 |
|------|-----|------|------|------|------|------|------|

**FTOI Rdest, Rsrc**

FTOI

*floating point Instructions*

FTOI

Float to Integer

[M32R-FPU Extended Instruction]

**[Supplemental Operation Description]**

The results of the FTOI instruction executed based on the Rsrc value, both when DN = 0 and DN = 1, are shown in below.

DN = 0

| Rsrc Value (exponent with no bias) |                     | Rdest                                                    | Exception                               |
|------------------------------------|---------------------|----------------------------------------------------------|-----------------------------------------|
| Rsrc ≥ 0                           | +Infinity           | When EIT occurs: no change                               | Invalid Operation Exception             |
|                                    | 127 ≥ exp ≥ 31      | Other EIT: H'7FFF FFFF                                   |                                         |
|                                    | 30 ≥ exp ≥ -126     | H'0000 0000 to H'7FFF FF80                               | No change (Note 1)                      |
|                                    | +Denormalized value | No change                                                | Unimplemented Exception                 |
|                                    | +0                  | H'0000 0000                                              | No change                               |
| Rsrc < 0                           | -0                  |                                                          |                                         |
|                                    | -Denormalized value | No change                                                | Unimplemented Exception                 |
|                                    | 30 ≥ exp ≥ -126     | H'0000 0000 to H'8000 0080                               | No change (Note 1)                      |
|                                    | 127 ≥ exp ≥ 31      | When EIT occurs: no change                               | Invalid Operation Exception<br>(Note 2) |
|                                    | -Infinity           | Other EIT: H'8000 0080                                   |                                         |
| NaN                                | QNaN                | When EIT occurs: no change<br>Other EIT:                 | Invalid Operation Exception             |
|                                    | SNaN                | Signed bit = 0:H'7FFF FFFF<br>Signed bit = 1:H'8000 0000 |                                         |

Note 1: Inexact Exception occurs when rounding is performed.

2: Inexact Exception does not occur when Rsrc = H'CF00 0000.

DN = 1

| Rsrc Value (exponent with no bias) |                         | Rdest                                                    | Exception                               |
|------------------------------------|-------------------------|----------------------------------------------------------|-----------------------------------------|
| Rsrc ≥ 0                           | +Infinity               | When EIT occurs: no change                               | Invalid Operation Exception             |
|                                    | 127 ≥ exp ≥ 31          | Other EIT: H'7FFF FFFF                                   |                                         |
|                                    | 30 ≥ exp ≥ -126         | H'0000 0000 to H'7FFF FF80                               | No change (Note 1)                      |
|                                    | +0, +Denormalized value | H'0000 0000                                              | No change                               |
| Rsrc < 0                           | -0, -Denormalized value |                                                          |                                         |
|                                    | 30 ≥ exp ≥ -126         | H'0000 0000 to H'8000 0080                               | No change (Note 1)                      |
|                                    | 127 ≥ exp ≥ 31          | When EIT occurs: no change                               | Invalid Operation Exception<br>(Note 2) |
|                                    | -Infinity               | Other EIT: H'8000 0000                                   |                                         |
| NaN                                | QNaN                    | When EIT occurs: no change<br>Other EIT:                 | Invalid Operation Exception             |
|                                    | SNaN                    | Signed bit = 0:H'7FFF FFFF<br>Signed bit = 1:H'8000 0000 |                                         |

Note 1: Inexact Exception occurs when rounding is performed.

2: Inexact Exception does not occur when Rsrc = H'CF00 0000.

**FTOS***floating-point Instructions***Float to short****FTOS****[M32R-FPU Extended Instruction]****[Mnemonic]****FTOS Rdest, Rsrc****[Function]**

Convert the floating-point single precision value to 16-bit integer.

Rdest = (signed int) Rsrc ;

**[Description]**

Convert the floating-point single precision value stored in Rsrc to a 16-bit integer and store the result in Rdest.

The result is rounded toward 0 regardless of the value in the RM field of FPSR. The condition bit (C) remains unchanged.

**[EIT occurrence]**

Floating-Point Exceptions (FPE)

- Unimplemented Operation Exception (UIPL)
- Invalid Operation Exception (IVLD)
- Inexact Exception (IXCT)

**[Encoding]**

|      |     |      |      |      |      |      |      |
|------|-----|------|------|------|------|------|------|
| 1101 | src | 0000 | 0000 | 0100 | dest | 1100 | 0000 |
|------|-----|------|------|------|------|------|------|

**FTOS Rdest, Rsrc**

FTOS

*floating point Instructions*

FTOS

Float to short

[M32R-FPU Extended Instruction]

**[Supplemental Operation Description]**

The results of the FTOS instruction executed based on the Rsrc value, both when DN = 0 and DN = 1, are shown in below.

DN = 0

| Rsrc Value (exponent with no bias) |                     | Rdest                                                    | Exception                               |
|------------------------------------|---------------------|----------------------------------------------------------|-----------------------------------------|
| Rsrc ≥ 0                           | +Infinity           | When EIT occurs: no change                               | Invalid Operation Exception             |
|                                    | 127 ≥ exp ≥ 15      | Other EIT: H'0000 7FFFF                                  |                                         |
|                                    | 14 ≥ exp ≥ -126     | H'0000 0000 to H'0000 7FFF                               | No change (Note 1)                      |
|                                    | +Denormalized value | No change                                                | Unimplemented Exception                 |
|                                    | +0                  | H'0000 0000                                              | No change                               |
| Rsrc < 0                           | -0                  |                                                          |                                         |
|                                    | -Denormalized value | No change                                                | Unimplemented Exception                 |
|                                    | 14 ≥ exp ≥ -126     | H'0000 0000 to H'FFFF 8001                               | No change (Note 1)                      |
|                                    | 127 ≥ exp ≥ 15      | When EIT occurs: no change                               | Invalid Operation Exception<br>(Note 2) |
|                                    | -Infinity           | Other EIT: H'FFFF 8000                                   |                                         |
| NaN                                | QNaN                | When EIT occurs: no change<br>Other EIT:                 | Invalid Operation Exception             |
|                                    | SNaN                | Signed bit = 0:H'0000 7FFF<br>Signed bit = 1:H'FFFF 8000 |                                         |

Note 1: Inexact Exception occurs when rounding is performed.

2: Inexact Exception does not occur when Rsrc = H'CF00 0000.

DN = 1

| Rsrc Value (exponent with no bias) |                         | Rdest                                                    | Exception                               |
|------------------------------------|-------------------------|----------------------------------------------------------|-----------------------------------------|
| Rsrc ≥ 0                           | +Infinity               | When EIT occurs: no change                               | Invalid Operation Exception             |
|                                    | 127 ≥ exp ≥ 15          | Other EIT: H'0000 7FFF                                   |                                         |
|                                    | 14 ≥ exp ≥ -126         | H'0000 0000 to H'0000 7FFF                               | No change (Note 1)                      |
|                                    | +0, +Denormalized value | H'0000 0000                                              | No change                               |
| Rsrc < 0                           | -0, -Denormalized value |                                                          |                                         |
|                                    | 14 ≥ exp ≥ -126         | H'0000 0000 to H'FFFF 8001                               | No change (Note 1)                      |
|                                    | 127 ≥ exp ≥ 15          | When EIT occurs: no change                               | Invalid Operation Exception<br>(Note 2) |
|                                    | -Infinity               | Other EIT: H'FFFF 8000                                   |                                         |
| NaN                                | QNaN                    | When EIT occurs: no change<br>Other EIT:                 | Invalid Operation Exception             |
|                                    | SNaN                    | Signed bit = 0:H'0000 7FFF<br>Signed bit = 1:H'FFFF 8000 |                                         |

Note 1: Inexact Exception occurs when rounding is performed.

2: No Exceptions occur when Rsrc = H'C700 0000. When Rsrc = H'C700 0001 to H'C700 00FF, the Inexact Exception occurs and the Invalid Operation Exception does not occur.

**ITOF***floating-point Instructions***Integer to float****[M32R-FPU Extended Instruction]****ITOF****[Mnemonic]****ITOF Rdest, Rsrc****[Function]**

Convert the integer to a floating-point single precision value.

Rdes = (float) Rsrc ;

**[Description]**

Converts the 32-bit integer stored in Rsrc to a floating-point single precision value and stores the result in Rdest. The result is rounded according to the RM field of FPSR. The condition bit (C) remains unchanged. H'0000 0000 is handled as "+0" regardless of the Rounding Mode.

**[EIT occurrence]**

Floating-Point Exceptions (FPE)

- Inexact Exception (IXCT)

**[Encoding]**

|      |     |      |      |      |      |      |      |
|------|-----|------|------|------|------|------|------|
| 1101 | src | 0000 | 0000 | 0100 | dest | 0000 | 0000 |
|------|-----|------|------|------|------|------|------|

**ITOF Rdest, Rsrc**



**JL***branch instruction***Jump and link****JL****[Mnemonic]****JL Rsrc****[Function]**

Subroutine call (register direct)

 $R14 = (PC \& 0\text{xffffffc}) + 4;$  $PC = Rsrc \& 0\text{xffffffc};$ **[Description]**

JL causes an unconditional jump to the address specified by Rsrc and puts the return address in R14.

The condition bit (C) is unchanged.

**[EIT occurrence]**

None

**[Encoding]**

|      |      |      |     |
|------|------|------|-----|
| 0001 | 1110 | 1100 | src |
|------|------|------|-----|

**JL Rsrc**

**JMP***branch instruction***Jump****JMP****[Mnemonic]****JMP Rsrc****[Function]**

Jump

PC = Rsrc &amp; 0xffffffc;

**[Description]**

JMP causes an unconditional jump to the address specified by Rsrc.  
The condition bit (C) is unchanged.

**[EIT occurrence]**

None

**[Encoding]**

|      |      |      |     |
|------|------|------|-----|
| 0001 | 1111 | 1100 | src |
|------|------|------|-----|

**JMP Rsrc**

**LD***load/store instruction***Load****LD****[Mnemonic]**

- (1) **LD Rdest,@Rsrc**
- (2) **LD Rdest,@Rsrc+**
- (3) **LD Rdest,@(disp16,Rsrc)**

**[Function]**

Load to register from the contents of the memory.

- (1)  $Rdest = *(int *) Rsrc;$
- (2)  $Rdest = *(int *) Rsrc, Rsrc += 4;$
- (3)  $Rdest = *(int *) (Rsrc + (signed\ short)\ disp16);$

**[Description]**

- (1) The contents of the memory at the address specified by Rsrc are loaded into Rdest.
- (2) The contents of the memory at the address specified by Rsrc are loaded into Rdest. Rsrc is post incremented by 4.
- (3) The contents of the memory at the address specified by Rsrc combined with the 16-bit displacement are loaded into Rdest.  
The displacement value is sign-extended to 32 bits before the address calculation.  
The condition bit (C) is unchanged.

**[EIT occurrence]**

Address exception (AE)

**[Encoding]**

|      |      |      |     |                                |
|------|------|------|-----|--------------------------------|
| 0010 | dest | 1100 | src | <b>LD Rdest,@Rsrc</b>          |
| 0010 | dest | 1110 | src | <b>LD Rdest,@Rsrc+</b>         |
| 1010 | dest | 1100 | src | <b>LD Rdest,@(disp16,Rsrc)</b> |

**LD Rdest,@(disp16,Rsrc)**

**LD24**

*load/store instruction*  
**Load 24-bit immediate**

**LD24****[Mnemonic]**

```
LD24 Rdest, #imm24
```

**[Function]**

Load the 24-bit immediate value into register.  
 Rdest = imm24 & 0x00ffffff;

**[Description]**

LD24 loads the 24-bit immediate value into Rdest. The immediate value is zero-extended to 32 bits.

The condition bit (C) is unchanged.

**[EIT occurrence]**

None

**[Encoding]**

|      |      |  |       |
|------|------|--|-------|
| 1110 | dest |  | imm24 |
|------|------|--|-------|

```
LD24 Rdest, #imm24
```

**LDB***load/store instruction***Load byte****LDB****[Mnemonic]**

- (1) **LDB Rdest,@Rsrc**
- (2) **LDB Rdest,@(disp16,Rsrc)**

**[Function]**

Load to register from the contents of the memory.

- (1)  $Rdest = *(signed\ char\ *)\ Rsrc;$
- (2)  $Rdest = *(signed\ char\ *)\ (Rsrc + (signed\ short)\ disp16);$

**[Description]**

- (1) LDB sign-extends the byte data of the memory at the address specified by Rsrc and loads it into Rdest.
- (2) LDB sign-extends the byte data of the memory at the address specified by Rsrc combined with the 16-bit displacement, and loads it into Rdest.  
The displacement value is sign-extended to 32 bits before the address calculation.  
The condition bit (C) is unchanged.

**[EIT occurrence]**

None

**[Encoding]**

|      |      |      |     |     |             |
|------|------|------|-----|-----|-------------|
| 0010 | dest | 1000 | src | LDB | Rdest,@Rsrc |
| 1010 | dest | 1000 | src |     | disp16      |

**LDB Rdest,@(disp16,Rsrc)**

**LDH***load/store instruction***Load halfword****LDH****[Mnemonic]**

- (1) **LDH Rdest,@Rsrc**
- (2) **LDH Rdest,@(disp16,Rsrc)**

**[Function]**

Load to register from the contents of the memory.

- (1)  $Rdest = *(signed\ short\ *)\ Rsrc;$
- (2)  $Rdest = *(signed\ short\ *)\ (Rsrc + (signed\ short)\ disp16);$

**[Description]**

- (1) LDH sign-extends the halfword data of the memory at the address specified by Rsrc and loads it into Rdest.
- (2) LDH sign-extends the halfword data of the memory at the address specified by Rsrc combined with the 16-bit displacement, and loads it into Rdest.  
The displacement value is sign-extended to 32 bits before the address calculation.  
The condition bit (C) is unchanged.

**[EIT occurrence]**

Address exception (AE)

**[Encoding]**

|      |      |      |     |     |             |
|------|------|------|-----|-----|-------------|
| 0010 | dest | 1010 | src | LDH | Rdest,@Rsrc |
| 1010 | dest | 1010 | src |     | disp16      |

**LDH Rdest,@(disp16,Rsrc)**

**LDI**

*transfer instruction*  
**Load immediate**

**LDI****[Mnemonic]**

- (1) **LDI Rdest,#imm8**
- (2) **LDI Rdest,#imm16**

**[Function]**

Load the immediate value into register.

- (1) Rdest = ( signed char ) imm8;
- (2) Rdest = ( signed short ) imm16;

**[Description]**

- (1) LDI loads the 8-bit immediate value into Rdest.  
The immediate value is sign-extended to 32 bits.
- (2) LDI loads the 16-bit immediate value into Rdest.  
The immediate value is sign-extended to 32 bits.  
The condition bit (C) is unchanged.

**[EIT occurrence]**

None

**[Encoding]**

|      |      |      |      |     |             |
|------|------|------|------|-----|-------------|
| 0110 | dest | imm8 |      | LDI | Rdest,#imm8 |
| 1001 | dest | 1111 | 0000 |     | imm16       |

**LDI Rdest,#imm16**

**LDUB***load/store instruction*  
**Load unsigned byte****LDUB****[Mnemonic]**

- (1) **LDUB Rdest,@Rsrc**
- (2) **LDUB Rdest,@(disp16,Rsrc)**

**[Function]**

Load to register from the contents of the memory.

- (1)  $Rdest = *(unsigned\ char\ *)\ Rsrc;$
- (2)  $Rdest = *(unsigned\ char\ *)\ (Rsrc + (signed\ short)\ disp16);$

**[Description]**

- (1) LDUB zero-extends the byte data from the memory at the address specified by Rsrc and loads it into Rdest.
- (2) LDUB zero-extends the byte data of the memory at the address specified by Rsrc combined with the 16-bit displacement, and loads it into Rdest.  
The displacement value is sign-extended to 32 bits before address calculation.  
The condition bit (C) is unchanged.

**[EIT occurrence]**

None

**[Encoding]**

|      |      |      |     |        |             |
|------|------|------|-----|--------|-------------|
| 0010 | dest | 1001 | src | LDUB   | Rdest,@Rsrc |
| 1010 | dest | 1001 | src | disp16 |             |

**LDUB Rdest,@(disp16,Rsrc)**



**LDUH**

*load/store instruction*  
**Load unsigned halfword**

**LDUH****[Mnemonic]**

- (1) **LDUH Rdest,@Rsrc**
- (2) **LDUH Rdest,@(disp16,Rsrc)**

**[Function]**

Load to register from the contents of the memory.

- (1)  $Rdest = *(unsigned\ short\ *)\ Rsrc;$
- (2)  $Rdest = *(unsigned\ short\ *)\ (Rsrc + (signed\ short)\ disp16);$

**[Description]**

- (1) LDUH zero-extends the halfword data from the memory at the address specified by Rsrc and loads it into Rdest.
- (2) LDUH zero-extends the halfword data in memory at the address specified by Rsrc combined with the 16-bit displacement, and loads it into Rdest.  
 The displacement value is sign-extended to 32 bits before the address calculation.  
 The condition bit (C) is unchanged.

**[EIT occurrence]**

Address exception (AE)

**[Encoding]**

|      |      |      |     |                  |
|------|------|------|-----|------------------|
| 0010 | dest | 1011 | src | LDUH Rdest,@Rsrc |
| 1010 | dest | 1011 | src | disp16           |

**LDUH Rdest,@(disp16,Rsrc)**

**LOCK***load/store instruction***Load locked****LOCK****[Mnemonic]****LOCK Rdest,@Rsrc****[Function]**

Load locked

LOCK = 1, Rdest = \*( int \*) Rsrc;

**[Description]**

The contents of the word at the memory location specified by Rsrc are loaded into Rdest. The condition bit (C) is unchanged.

This instruction sets the LOCK bit in addition to simple loading.

When the LOCK bit is 1, external bus master access is not accepted.

The LOCK bit is cleared by executing the UNLOCK instruction.

The LOCK bit is located in the CPU and operates based on the LOCK and UNLOCK instructions. The user cannot directly read or write to this bit.

The LOCK bit is internal to the CPU and is the control bit for receiving all bus right requests from circuits other than the CPU.

Refer to the Users Manual for non-CPU bus right requests, as the handling differs according to the type of MCU.

**[EIT occurrence]**

Address exception (AE)

**[Encoding]**

|      |      |      |     |                         |
|------|------|------|-----|-------------------------|
| 0010 | dest | 1101 | src | <b>LOCK Rdest,@Rsrc</b> |
|------|------|------|-----|-------------------------|

**MACHI***DSP function instruction***Multiply-accumulate high-order halfwords****MACHI****[Mnemonic]****MACHI Rsrc1,Rsrc2****[Function]**

Multiply and add

accumulator += (( signed) (Rsrc1 &amp; 0xffff0000) \* (signed short) (Rsrc2 &gt;&gt; 16));

**[Description]**

MACHI multiplies the high-order 16 bits of Rsrc1 and the high-order 16 bits of Rsrc2, then adds the result to the low-order 56 bits in the accumulator.

The LSB of the multiplication result is aligned with bit 47 in the accumulator, and the portion corresponding to bits 8 through 15 of the accumulator is sign-extended before addition. The result of the addition is stored in the accumulator. The high-order 16 bits of Rsrc1 and Rsrc2 are treated as signed values.

The condition bit (C) is unchanged.

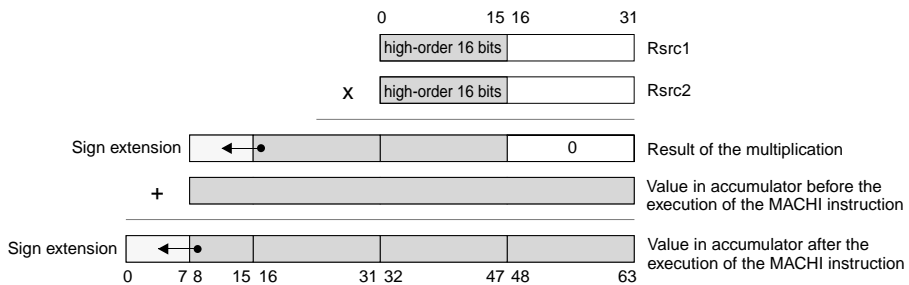
**[EIT occurrence]**

None

**[Encoding]**

|      |      |      |      |                          |
|------|------|------|------|--------------------------|
| 0011 | src1 | 0100 | src2 | <b>MACHI Rsrc1,Rsrc2</b> |
|------|------|------|------|--------------------------|

# MACLO *DSP function instruction* MACLO

## Multiply-accumulate low-order halfwords

**[Mnemonic]**

**MACLO Rsrc1,Rsrc2**

**[Function]**

Multiply and add

accumulator += ( ( signed ) ( Rsrc1 << 16 ) \* ( signed short ) Rsrc2 ) ;

**[Description]**

MACLO multiplies the low-order 16 bits of Rsrc1 and the low-order 16 bits of Rsrc2, then adds the result to the low order 56 bits in the accumulator.

The LSB of the multiplication result is aligned with bit 47 in the accumulator, and the portion corresponding to bits 8 through 15 of the accumulator is sign-extended before addition. The result of the addition is stored in the accumulator. The low-order 16 bits of Rsrc1 and Rsrc2 are treated as signed values.

The condition bit (C) is unchanged.

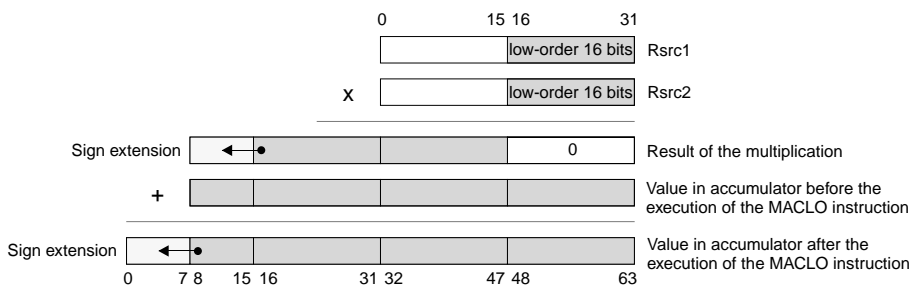
**[EIT occurrence]**

None

**[Encoding]**

|      |      |      |      |                          |
|------|------|------|------|--------------------------|
| 0011 | src1 | 0101 | src2 | <b>MACLO Rsrc1,Rsrc2</b> |
|------|------|------|------|--------------------------|

**MACWHI**

*DSP function instruction*  
**Multiply-accumulate**  
**word and high-order halfword**

**MACWHI****[Mnemonic]**

**MACWHI Rsrc1,Rsrc2**

**[Function]**

Multiply and add

accumulator += ( ( signed ) Rsrc1 \* ( signed short ) ( Rsrc2 >> 16 ) );

**[Description]**

MACWHI multiplies the 32 bits of Rsrc1 and the high-order 16 bits of Rsrc2, then adds the result to the low-order 56 bits in the accumulator.

The LSB of the multiplication result is aligned with the LSB of the accumulator, and the portion corresponding to bits 8 through 15 of the accumulator is sign extended before addition. The result of addition is stored in the accumulator. The 32 bits of Rsrc1 and the high-order 16 bits of Rsrc2 are treated as signed values.

The condition bit (C) is unchanged.

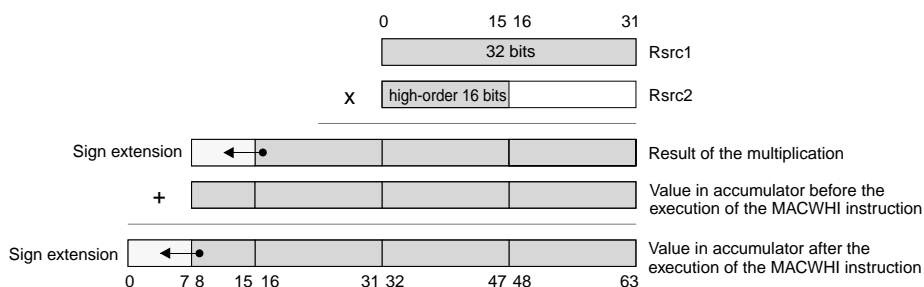
**[EIT occurrence]**

None

**[Encoding]**

|      |      |      |      |                           |
|------|------|------|------|---------------------------|
| 0011 | src1 | 0110 | src2 | <b>MACWHI Rsrc1,Rsrc2</b> |
|------|------|------|------|---------------------------|

**MACWLO**

*DSP function instruction*  
**Multiply-accumulate**  
**word and low-order halfword**

**MACWLO****[Mnemonic]**

**MACWLO Rsrc1,Rsrc2**

**[Function]**

Multiply and add  
 accumulator += ( ( signed ) Rsrc1 \* ( signed short ) Rsrc2 ) ;

**[Description]**

MACWLO multiplies the 32 bits of Rsrc1 and the low-order 16 bits of Rsrc2, then adds the result to the low-order 56 bits in the accumulator.

The LSB of the multiplication result is aligned with the LSB of the accumulator, and the portion corresponding to bits 8 through 15 of the accumulator is sign-extended before the addition. The result of the addition is stored in the accumulator. The 32 bits Rsrc1 and the low-order 16 bits of Rsrc2 are treated as signed values.

The condition bit (C) is unchanged.

**[EIT occurrence]**

None

**[Encoding]**

|      |      |      |      |        |             |
|------|------|------|------|--------|-------------|
| 0011 | src1 | 0111 | src2 | MACWLO | Rsrc1,Rsrc2 |
|------|------|------|------|--------|-------------|

**MUL***multiply and divide instruction***Multiply****MUL****[Mnemonic]****MUL Rdest, Rsrc****[Function]**

```

Multiply
{ signed64bit tmp;
tmp = (signed64bit) Rdest * (signed64bit) Rsrc;
Rdest = (int) tmp;}

```

**[Description]**

MUL multiplies Rdest by Rsrc and puts the result in Rdest.

The operands are treated as signed values.

**The contents of the accumulator are destroyed by this instruction.** The condition bit (C) is unchanged.

**[EIT occurrence]**

None

**[Encoding]**

|      |      |      |     |                        |
|------|------|------|-----|------------------------|
| 0001 | dest | 0110 | src | <b>MUL Rdest, Rsrc</b> |
|------|------|------|-----|------------------------|

**MULHI**

*DSP function instruction*  
**Multiply high-order halfwords**

**MULHI****[Mnemonic]**

**MULHI Rsrc1,Rsrc2**

**[Function]**

Multiply

accumulator = (( signed) (Rsrc1 & 0xffff000) \* (signed short) (Rsrc2 >> 16));

**[Description]**

MULHI multiplies the high-order 16 bits of Rsrc1 and the high-order 16 bits of Rsrc2, and stores the result in the accumulator.

However, the LSB of the multiplication result is aligned with bit 47 in the accumulator, and the portion corresponding to bits 0 through 15 of the accumulator is sign-extended. Bits 48 through 63 of the accumulator are cleared to 0. The high-order 16 bits of Rsrc1 and Rsrc2 are treated as signed values.

The condition bit (C) is unchanged.

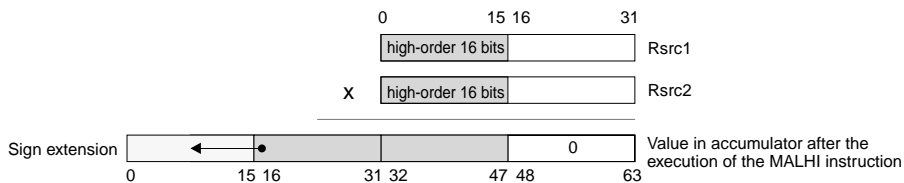
**[EIT occurrence]**

None

**[Encoding]**

|      |      |      |      |
|------|------|------|------|
| 0011 | src1 | 0000 | src2 |
|------|------|------|------|

**MULHI Rsrc1,Rsrc2**



# MULLO

*DSP function instruction*  
**Multiply low-order halfwords**

# MULLO

**[Mnemonic]**

**MULLO Rsrc1,Rsrc2**

**[Function]**

Multiply

accumulator = ( ( signed ) ( Rsrc1 << 16 ) \* ( signed short ) Rsrc2 );

**[Description]**

MULLO multiplies the low-order 16 bits of Rsrc1 and the low-order 16 bits of Rsrc2, and stores the result in the accumulator.

The LSB of the multiplication result is aligned with bit 47 in the accumulator, and the portion corresponding to bits 0 through 15 of the accumulator is sign extended. Bits 48 through 63 of the accumulator are cleared to 0. The low-order 16 bits of Rsrc1 and Rsrc2 are treated as signed values.

The condition bit (C) is unchanged.

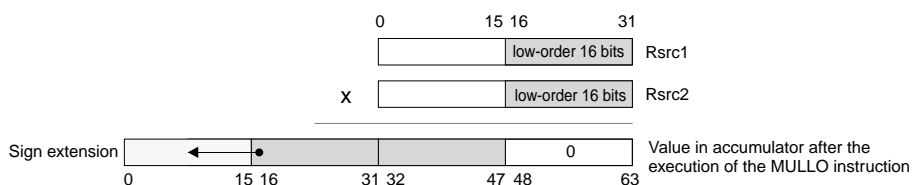
**[EIT occurrence]**

None

**[Encoding]**

|      |      |      |      |                          |
|------|------|------|------|--------------------------|
| 0011 | src1 | 0001 | src2 | <b>MULLO Rsrc1,Rsrc2</b> |
|------|------|------|------|--------------------------|

**MULWHI***DSP function instruction***Multiply****word and high-order halfword****MULWHI****[Mnemonic]****MULWHI Rsrc1,Rsrc2****[Function]**

Multiply

accumulator = ( ( signed ) Rsrc1 \* ( signed short ) ( Rsrc2 &gt;&gt; 16 ) );

**[Description]**

MULWHI multiplies the 32 bits of Rsrc1 and the high-order 16 bits of Rsrc2, and stores the result in the accumulator.

The LSB of the multiplication result is aligned with the LSB of the accumulator, and the portion corresponding to bits 0 through 15 of the accumulator is sign-extended. The 32 bits of Rsrc1 and high-order 16 bits of Rsrc2 are treated as signed values.

The condition bit (C) is unchanged.

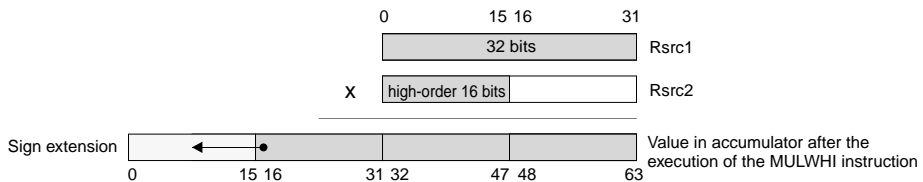
**[EIT occurrence]**

None

**[Encoding]**

|      |      |      |      |                           |
|------|------|------|------|---------------------------|
| 0011 | src1 | 0010 | src2 | <b>MULWHI Rsrc1,Rsrc2</b> |
|------|------|------|------|---------------------------|

**MULWLO***DSP function instruction***Multiply****word and low-order halfword****MULWLO****[Mnemonic]****MULWLO Rsrc1,Rsrc2****[Function]**

Multiply

accumulator = ( ( signed ) Rsrc1 \* ( signed short ) Rsrc2 );

**[Description]**

MULWLO multiplies the 32 bits of Rsrc1 and the low-order 16 bits of Rsrc2, and stores the result in the accumulator.

The LSB of the multiplication result is aligned with the LSB of the accumulator, and the portion corresponding to bits 0 through 15 of the accumulator is sign extended. The 32 bits of Rsrc1 and low-order 16 bits of Rsrc2 are treated as signed values.

The condition bit (C) is unchanged.

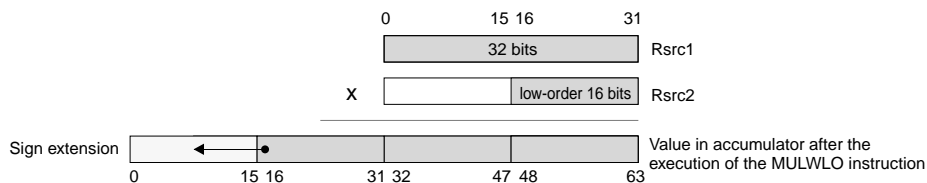
**[EIT occurrence]**

None

**[Encoding]**

|      |      |      |      |
|------|------|------|------|
| 0011 | src1 | 0011 | src2 |
|------|------|------|------|

**MULWLO Rsrc1,Rsrc2**

**MV***transfer instruction***Move register****MV****[Mnemonic]****MV Rdest,Rsrc****[Function]**

Transfer

Rdest = Rsrc;

**[Description]**

MV moves Rsrc to Rdest.

The condition bit (C) is unchanged.

**[EIT occurrence]**

None

**[Encoding]**

|      |      |      |     |
|------|------|------|-----|
| 0001 | dest | 1000 | src |
|------|------|------|-----|

**MV Rdest,Rsrc**

**MVFACHI**

*DSP function instruction*  
**Move high-order word  
 from accumulator**

**MVFACHI****[Mnemonic]**

**MVFACHI Rdest**

**[Function]**

Transfer from accumulator to register  
 $Rdest = (int)(accumulator \gg 32);$

**[Description]**

MVFACHI moves the high-order 32 bits of the accumulator to Rdest.  
 The condition bit (C) is unchanged.

**[EIT occurrence]**

None

**[Encoding]**

|      |      |      |      |                      |
|------|------|------|------|----------------------|
| 0101 | dest | 1111 | 0000 | <b>MVFACHI Rdest</b> |
|------|------|------|------|----------------------|

**MVFACLO**

*DSP function instruction*  
**Move low-order word  
 from accumulator**

**MVFACLO****[Mnemonic]**

**MVFACLO Rdest**

**[Function]**

Transfer from accumulator to register  
 Rdest = ( int ) accumulator

**[Description]**

MVFACLO moves the low-order 32 bits of the accumulator to Rdest.  
 The condition bit (C) is unchanged.

**[EIT occurrence]**

None

**[Encoding]**

|      |      |      |      |
|------|------|------|------|
| 0101 | dest | 1111 | 0001 |
|------|------|------|------|

**MVFACLO Rdest**

**MVFACMI**

*DSP function instruction*  
**Move middle-order word  
 from accumulator**

**MVFACMI****[Mnemonic]**

**MVFACMI Rdest**

**[Function]**

Transfer from accumulator to register  
 $Rdest = (int)(accumulator \gg 16);$

**[Description]**

MVFACMI moves bits 16 through 47 of the accumulator to Rdest.  
 The condition bit (C) is unchanged.

**[EIT occurrence]**

None

**[Encoding]**

|      |      |      |      |
|------|------|------|------|
| 0101 | dest | 1111 | 0010 |
|------|------|------|------|

**MVFACMI Rdest**

**MVFC**

*transfer instruction*  
**Move from control register**

**MVFC****[Mnemonic]**

**MVFC Rdest,CRsrc**

**[Function]**

Transfer from control register to register  
 Rdest = CRsrc ;

**[Description]**

MVFC moves CRsrc to Rdest.  
 The condition bit (C) is unchanged.

**[EIT occurrence]**

None

**[Encoding]**

|      |      |      |     |                         |
|------|------|------|-----|-------------------------|
| 0001 | dest | 1001 | src | <b>MVFC Rdest,CRsrc</b> |
|------|------|------|-----|-------------------------|



**MVTACHI**

*DSP function instruction*  
**Move high-order word  
to accumulator**

**MVTACHI****[Mnemonic]**

**MVTACHI Rsrc**

**[Function]**

Transfer from register to accumulator  
accumulator [ 0 : 31 ] = Rsrc ;

**[Description]**

MVTACHI moves Rsrc to the high-order 32 bits of the accumulator.  
The condition bit (C) is unchanged.

**[EIT occurrence]**

None

**[Encoding]**

|      |     |      |      |                     |
|------|-----|------|------|---------------------|
| 0101 | src | 0111 | 0000 | <b>MVTACHI Rsrc</b> |
|------|-----|------|------|---------------------|

**MVTACLO**

*DSP function instruction*  
**Move low-order word  
to accumulator**

**MVTACLO****[Mnemonic]**

**MVTACLO Rsrc**

**[Function]**

Transfer from register to accumulator  
accumulator [ 32 : 63 ] = Rsrc ;

**[Description]**

MVTACLO moves Rsrc to the low-order 32 bits of the accumulator.  
The condition bit (C) is unchanged.

**[EIT occurrence]**

None

**[Encoding]**

|      |     |      |      |
|------|-----|------|------|
| 0101 | src | 0111 | 0001 |
|------|-----|------|------|

**MVTACLO Rsrc**

**MVTC**

*transfer instruction*  
**Move to control register**

**MVTC****[Mnemonic]**

**MVTC Rsrc,CRdest**

**[Function]**

Transfer from register to control register  
 CRdest = Rsrc ;

**[Description]**

MVTC moves Rsrc to CRdest.

If PSW(CR0) is specified as CRdest, the condition bit (C) is changed; otherwise it is unchanged.

**[EIT occurrence]**

None

**[Encoding]**

|      |      |      |     |                         |
|------|------|------|-----|-------------------------|
| 0001 | dest | 1010 | src | <b>MVTC Rsrc,CRdest</b> |
|------|------|------|-----|-------------------------|

**NEG***arithmetic operation instruction***Negate****NEG****[Mnemonic]****NEG Rdest, Rsrc****[Function]**

Negate

 $Rdest = 0 - Rsrc ;$ **[Description]**

NEG negates (changes the sign of) Rsrc treated as a signed 32-bit value, and puts the result in Rdest.

The condition bit (C) is unchanged.

**[EIT occurrence]**

None

**[Encoding]**

|      |      |      |     |
|------|------|------|-----|
| 0000 | dest | 0011 | src |
|------|------|------|-----|

**NEG Rdest, Rsrc**

**NOP***branch instruction***No operation****NOP****[Mnemonic]**

NOP

**[Function]**

No operation

/\* \*/

**[Description]**

NOP performs no operation. The subsequent instruction then processed.

The condition bit (C) is unchanged.

**[EIT occurrence]**

None

**[Encoding]**

|      |      |      |      |     |
|------|------|------|------|-----|
| 0111 | 0000 | 0000 | 0000 | NOP |
|------|------|------|------|-----|

**NOT***logic operation instruction***Logical NOT****NOT****[Mnemonic]****NOT Rdest, Rsrc****[Function]**

Logical NOT

Rdest = ~ Rsrc ;

**[Description]**

NOT inverts each of the bits of Rsrc and puts the result in Rdest.  
The condition bit (C) is unchanged.

**[EIT occurrence]**

None

**[Encoding]**

|      |      |      |     |
|------|------|------|-----|
| 0000 | dest | 1011 | src |
|------|------|------|-----|

**NOT Rdest, Rsrc**

**OR***logic operation instruction***OR****OR****[Mnemonic]****OR Rdest,Rsrc****[Function]**

Logical OR

 $Rdest = Rdest \mid Rsrc ;$ **[Description]**

OR computes the logical OR of the corresponding bits of Rdest and Rsrc, and puts the result in Rdest.

The condition bit (C) is unchanged.

**[EIT occurrence]**

None

**[Encoding]**

|      |      |      |     |
|------|------|------|-----|
| 0000 | dest | 1110 | src |
|------|------|------|-----|

**OR Rdest,Rsrc**

**OR3***logic operation instruction*  
**OR 3-operand****OR3****[Mnemonic]****OR3 Rdest,Rsrc,#imm16****[Function]**

Logical OR

$$Rdest = Rsrc \mid (\text{unsigned short}) \text{imm16} ;$$
**[Description]**

OR3 computes the logical OR of the corresponding bits of Rsrc and the 16-bit immediate value, which is zero-extended to 32 bits, and puts the result in Rdest.

The condition bit (C) is unchanged.

**[EIT occurrence]**

None

**[Encoding]**

|      |      |      |     |       |  |  |  |
|------|------|------|-----|-------|--|--|--|
| 1000 | dest | 1110 | src | imm16 |  |  |  |
|------|------|------|-----|-------|--|--|--|

**OR3 Rdest,Rsrc,#imm16**



**RAC**

*DSP function instruction*  
**Round accumulator**

**RAC****[Mnemonic]**

**RAC**

**[Function]**

```
Saturation Process
{ signed64bit tmp;
tmp = (signed64bit) accumulator << 1;
tmp = tmp + 0x0000 0000 0000 8000;
if(0x0000 7fff ffff 0000 < tmp)
 accumulator = 0x0000 7fff ffff 0000;
else if(tmp < 0xffff 8000 0000 0000)
 accumulator = 0xffff 8000 0000 0000;
else
 accumulator = tmp & 0xffff ffff ffff 0000; }
```

**[Description]**

RAC rounds the contents in the accumulator to word size and stores the result in the accumulator.

The condition bit (C) is unchanged.

**[EIT occurrence]**

None

**[Encoding]**

|      |      |      |      |            |
|------|------|------|------|------------|
| 0101 | 0000 | 1001 | 0000 | <b>RAC</b> |
|------|------|------|------|------------|

RAC

DSP function instruction  
Round accumulator

RAC

[Supplement]

This instruction is executed in two steps as shown below:

<step 1>

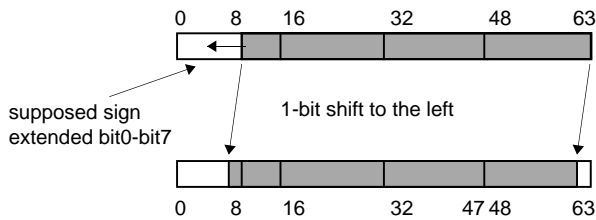

<step 2>

The value in the accumulator is altered depending on the supposed bit 80 through 7 after left-shift operation and bit 8 through bit 63 after shift operation.

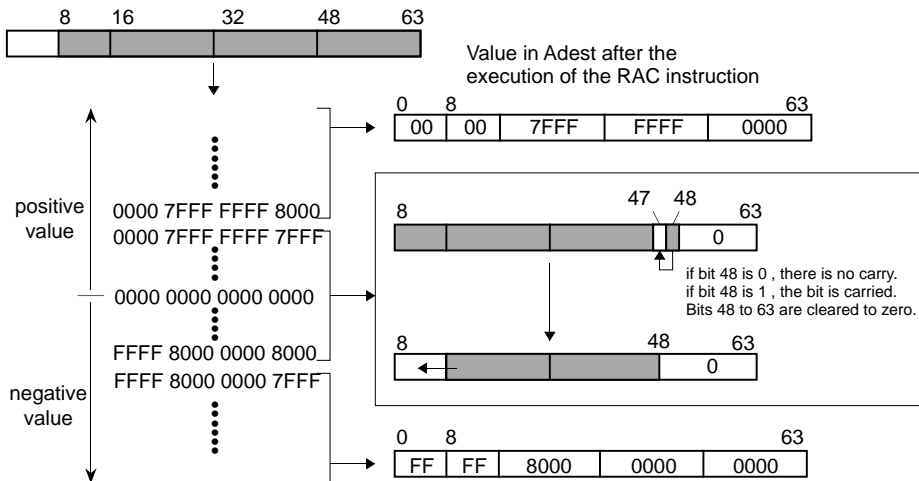

**RACH**

*DSP function instruction*  
**Round accumulator halfword**

**RACH****[Mnemonic]****RACH****[Function]**

```
Saturation Process
{ signed64bit tmp;
tmp = (signed64bit) accumulator << 1;
tmp = tmp + 0x0000 0000 8000 0000;
if(0x0000 7fff 0000 0000 < tmp)
 accumulator = 0x0000 7fff 0000 0000;
else if(tmp < 0xffff 8000 0000 0000)
 accumulator = 0xffff 8000 0000 0000;
else
 accumulator = tmp & 0xffff ffff 0000 0000; }
```

**[Description]**

RACH rounds the contents in the accumulator to halfword size and stores the result in the accumulator.

The condition bit (C) is unchanged.

**[EIT occurrence]**

None

**[Encoding]**

|      |      |      |      |             |
|------|------|------|------|-------------|
| 0101 | 0000 | 1000 | 0000 | <b>RACH</b> |
|------|------|------|------|-------------|

RACH

DSP function instruction  
Round accumulator halfword

RACH

[Supplement]

This instruction is executed in two steps, as shown below.

<process 1>

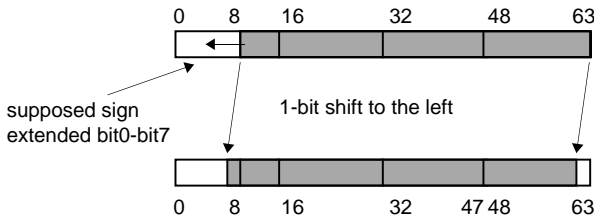

<process 2>

The value in the accumulator is altered depending on the supposed bit 80 through 7 after left-shift operation and bit 8 through bit 63 after shift operation.

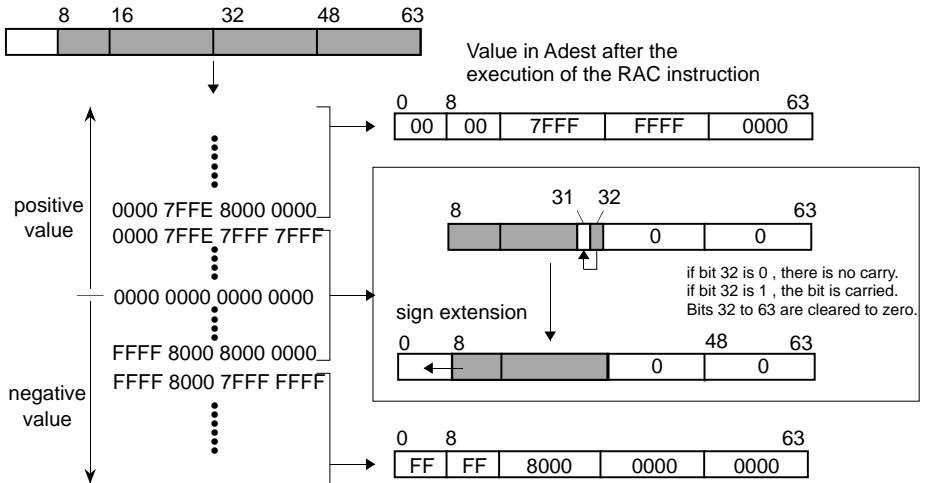

**REM***multiply and divide instruction***Remainder****REM****[Mnemonic]****REM Rdest, Rsrc****[Function]**

Signed remainder

 $Rdest = (\text{signed}) Rdest \% (\text{signed}) Rsrc ;$ **[Description]**

REM divides Rdest by Rsrc and puts the quotient in Rdest. The operands are treated as signed 32-bit values.

The quotient is rounded toward zero and the quotient takes the same sign as the dividend.

The condition bit (C) is unchanged.

When Rsrc is zero, Rdest is unchanged.

**[EIT occurrence]**

None

**[Encoding]**

|      |      |      |     |      |      |      |      |
|------|------|------|-----|------|------|------|------|
| 1001 | dest | 0010 | src | 0000 | 0000 | 0000 | 0000 |
|------|------|------|-----|------|------|------|------|

**REM Rdest, Rsrc**

**REMU***multiply and divide instruction***Remainder unsigned****REMU****[Mnemonic]****REMU Rdest, Rsrc****[Function]**

Unsigned remainder

 $Rdest = (\text{unsigned}) Rdest \% (\text{unsigned}) Rsrc ;$ **[Description]**

REMU divides Rdest by Rsrc and puts the quotient in Rdest.

The operands are treated as unsigned 32-bit values.

The condition bit (C) is unchanged.

When Rsrc is zero, Rdest is unchanged.

**[EIT occurrence]**

None

**[Encoding]**

|      |      |      |     |      |      |      |      |
|------|------|------|-----|------|------|------|------|
| 1001 | dest | 0011 | src | 0000 | 0000 | 0000 | 0000 |
|------|------|------|-----|------|------|------|------|

**REMU Rdest, Rsrc**

**RTE***EIT-related instruction***Return from EIT****RTE****[Mnemonic]****RTE****[Function]**

Return from EIT

SM = BSM ;

IE = BIE ;

C = BC ;

PC = BPC &amp; 0xfffffc ;

**[Description]**

RTE restores the SM, IE and C bits of the PSW from the BSM, BIE and BC bits, and jumps to the address specified by BPC.

At this time, because the BSM, BIE, and BC bits in the PSW register are undefined, the BPC is also undefined.

**[EIT occurrence]**

None

**[Encoding]**

|      |      |      |      |            |
|------|------|------|------|------------|
| 0001 | 0000 | 1101 | 0110 | <b>RTE</b> |
|------|------|------|------|------------|

**SETH**

*Transfer instructions*  
**Set high-order 16-bit**

**SETH****[Mnemonic]**

```
SETH Rdest, #imm16
```

**[Function]**

Transfer instructions

$$Rdest = (\text{signed short}) \text{imm16} \ll 16 ;$$
**[Description]**

SETH load the immediate value into the 16 most significant bits of Rdest.

The 16 least significant bits become zero.

The condition bit (C) is unchanged.

**[EIT occurrence]**

None

**[Encoding]**

|      |      |      |      |       |
|------|------|------|------|-------|
| 1101 | dest | 1100 | 0000 | imm16 |
|------|------|------|------|-------|

```
SETH Rdest, #imm16
```



**SETPSW***Bit Operation Instructions***Set PSW****SETPSW****[M32R-FPU Extended Instruction]****[Mnemonic]****SETPSW #imm8****[Function]**

Set the undefined SM, IE, and C bits of PSW to 1.

PSW := imm8&amp;0x000000ff

**[Description]**

Set the AND result of the value of b0 (MSB), b1, and b7 (LSB) of the 8-bit immediate value and bits SM, IE, and C of PSW to the corresponding SM, IE, and C bits. When b7 (LSB) or #imm8 is 1, the condition bit (C) goes to 0. All other bits remain unchanged.

**[EIT occurrence]**

None

**[Encoding]**

|      |      |      |                     |
|------|------|------|---------------------|
| 0111 | 0001 | imm8 | <b>SETPSW #imm8</b> |
|------|------|------|---------------------|

**[Note]**

Set the 8-bit immediate values of b2 to b6 to "0".

**SLL**

*shift instruction*  
**Shift left logical**

**SLL****[Mnemonic]**

**SLL Rdest, Rsrc**

**[Function]**

Logical left shift

$Rdest = Rdest \ll (Rsrc \& 31)$  ;

**[Description]**

SLL left logical-shifts the contents of Rdest by the number specified by Rsrc, shifting zeroes into the least significant bits.

Only the five least significant bits of Rsrc are used.

The condition bit (C) is unchanged.

**[EIT occurrence]**

None

**[Encoding]**

|      |      |      |     |                        |
|------|------|------|-----|------------------------|
| 0001 | dest | 0100 | src | <b>SLL Rdest, Rsrc</b> |
|------|------|------|-----|------------------------|

**SLL3**

*shift instruction*  
Shift left logical 3-operand

**SLL3****[Mnemonic]**

**SLL3** *Rdest, Rsrc, #imm16*

**[Function]**

Logical left shift

$Rdest = Rsrc \ll (imm16 \& 31)$  ;

**[Description]**

SLL3 left logical-shifts the contents of Rsrc into Rdest by the number specified by the 16-bit immediate value, shifting zeroes into the least significant bits.

Only the five least significant bits of the 16-bit immediate value are used.

The condition bit (C) is unchanged.

**[EIT occurrence]**

None

**[Encoding]**

|      |      |      |     |       |
|------|------|------|-----|-------|
| 1001 | dest | 1100 | src | imm16 |
|------|------|------|-----|-------|

**SLL3** *Rdest, Rsrc, #imm16*

**SLLI**

*shift instruction*  
**Shift left logical immediate**

**SLLI****[Mnemonic]**

```
SLLI Rdest, #imm5
```

**[Function]**

Logical left shift  
 $Rdest = Rdest \ll imm5$  ;

**[Description]**

SLLI left logical-shifts the contents of Rdest by the number specified by the 5-bit immediate value, shifting zeroes into the least significant bits.

The condition bit (C) is unchanged.

**[EIT occurrence]**

None

**[Encoding]**

|      |      |     |      |      |              |
|------|------|-----|------|------|--------------|
| 0101 | dest | 010 | imm5 | SLLI | Rdest, #imm5 |
|------|------|-----|------|------|--------------|

**SRA**

*shift instruction*  
**Shift right arithmetic**

**SRA****[Mnemonic]****SRA Rdest,Rsrc****[Function]**

Arithmetic right shift

$$\text{Rdest} = (\text{signed}) \text{Rdest} \gg (\text{Rsrc} \& 31);$$
**[Description]**

SRA right arithmetic-shifts the contents of Rdest by the number specified by Rsrc, replicates the sign bit in the MSB of Rdest and puts the result in Rdest.

Only the five least significant bits are used.

The condition bit (C) is unchanged.

**[EIT occurrence]**

None

**[Encoding]**

|      |      |      |     |
|------|------|------|-----|
| 0001 | dest | 0010 | src |
|------|------|------|-----|

**SRA Rdest,Rsrc**

**SRA3**

*shift instruction*  
**Shift right arithmetic 3-operand**

**SRA3****[Mnemonic]**

**SRA3 Rdest,Rsrc,#imm16**

**[Function]**

Arithmetic right shift

$Rdest = (\text{signed}) Rsrc \gg (\text{imm16} \& 31);$

**[Description]**

SRA3 right arithmetic-shifts the contents of Rsrc into Rdest by the number specified by the 16-bit immediate value, replicates the sign bit in Rsrc and puts the result in Rdest.

Only the five least significant bits are used.

The condition bit (C) is unchanged.

**[EIT occurrence]**

None

**[Encoding]**

|      |      |      |     |       |
|------|------|------|-----|-------|
| 1001 | dest | 1010 | src | imm16 |
|------|------|------|-----|-------|

**SRA3 Rdest,Rsrc,#imm16**

**SRAI***shift instruction***Shift right arithmetic immediate****SRAI****[Mnemonic]****SRAI Rdest, #imm5****[Function]**

Arithmetic right shift

Rdest = ( signed ) Rdest &gt;&gt; imm5 ;

**[Description]**

SRAI right arithmetic-shifts the contents of Rdest by the number specified by the 5-bit immediate value, replicates the sign bit in MSB of Rdest and puts the result in Rdest.

The condition bit (C) is unchanged.

**[EIT occurrence]**

None

**[Encoding]**

|      |      |     |      |                   |
|------|------|-----|------|-------------------|
| 0101 | dest | 001 | imm5 | SRAI Rdest, #imm5 |
|------|------|-----|------|-------------------|

**SRL**

*shift instruction*  
**Shift right logical**

**SRL****[Mnemonic]**

**SRL Rdest,Rsrc**

**[Function]**

Logical right shift

$Rdest = (\text{unsigned}) Rdest \gg (Rsrc \& 31);$

**[Description]**

SRL right logical-shifts the contents of Rdest by the number specified by Rsrc, shifts zeroes into the most significant bits and puts the result in Rdest.

Only the five least significant bits of Rsrc are used.

The condition bit (C) is unchanged.

**[EIT occurrence]**

None

**[Encoding]**

|      |      |      |     |                |
|------|------|------|-----|----------------|
| 0001 | dest | 0000 | src | SRL Rdest,Rsrc |
|------|------|------|-----|----------------|



**SRL3**

*shift instruction*  
**Shift right logical 3-operand**

**SRL3****[Mnemonic]**

```
SRL3 Rdest,Rsrc,#imm16
```

**[Function]**

Logical right shift

$$Rdest = (\text{unsigned}) Rsrc \gg (\text{imm16} \& 31);$$
**[Description]**

SRL3 right logical-shifts the contents of Rsrc into Rdest by the number specified by the 16-bit immediate value, shifts zeroes into the most significant bits. Only the five least significant bits of the immediate value are valid.

The condition bit (C) is unchanged.

**[EIT occurrence]**

None

**[Encoding]**

|      |      |      |     |       |
|------|------|------|-----|-------|
| 1001 | dest | 1000 | src | imm16 |
|------|------|------|-----|-------|

```
SRL3 Rdest,Rsrc,#imm16
```

**SRLI**

*shift instruction*  
**Shift right logical immediate**

**SRLI****[Mnemonic]**

```
SRLI Rdest, #imm5
```

**[Function]**

Logical right shift

$$Rdest = (\text{unsigned}) Rdest \gg (\text{imm5} \& 31);$$
**[Description]**

SRLI right arithmetic-shifts Rdest by the number specified by the 5-bit immediate value, shifting zeroes into the most significant bits.

The condition bit (C) is unchanged.

**[EIT occurrence]**

None

**[Encoding]**

|      |      |     |      |      |              |
|------|------|-----|------|------|--------------|
| 0101 | dest | 000 | imm5 | SRLI | Rdest, #imm5 |
|------|------|-----|------|------|--------------|

**ST***load/store instruction***Store****ST****[Mnemonic]**

- (1) **ST Rsrc1,@Rsrc2**
- (2) **ST Rsrc1,@+Rsrc2**
- (3) **ST Rsrc1,@-Rsrc2**
- (4) **ST Rsrc1,@(disp16,Rsrc2)**

**[Function]**

Store

- (1) \* ( int \*) Rsrc2 = Rsrc1;
- (2) Rsrc2 += 4, \* ( int \*) Rsrc2 = Rsrc1;
- (3) Rsrc2 -= 4, \* ( int \*) Rsrc2 = Rsrc1;
- (4) \* ( int \*) ( Rsrc2 + ( signed short ) disp16 ) = Rsrc1;

**[Description]**

- (1) ST stores Rsrc1 in the memory at the address specified by Rsrc2.
- (2) ST increments Rsrc2 by 4 and stores Rsrc1 in the memory at the address specified by the resultant Rsrc2.
- (3) ST decrements Rsrc2 by 4 and stores the contents of Rsrc1 in the memory at the address specified by the resultant Rsrc2.
- (4) ST stores Rsrc1 in the memory at the address specified by Rsrc combined with the 16-bit displacement. The displacement value is sign-extended before the address calculation. The condition bit (C) is unchanged.

**[EIT occurrence]**

Address exception (AE)

ST

*load/store instruction*  
Store

ST

[Encoding]

|      |      |      |      |                  |
|------|------|------|------|------------------|
| 0010 | src1 | 0100 | src2 | ST Rsrc1,@Rsrc2  |
| 0010 | src1 | 0110 | src2 | ST Rsrc1,@+Rsrc2 |
| 0010 | src1 | 0111 | src2 | ST Rsrc1,@-Rsrc2 |
| 1010 | src1 | 0100 | src2 | disp16           |

ST Rsrc1,@(disp16,Rsrc2)

**STB***load/store instruction***Store byte****STB****[Mnemonic]**

- (1) **STB Rsrc1,@Rsrc2**
- (2) **STB Rsrc1,@(disp16,Rsrc2)**

**[Function]**

Store

- (1) \* ( char \*) Rsrc2 = Rsrc1;
- (2) \* ( char \*) ( Rsrc2 + ( signed short ) disp16 ) = Rsrc1;

**[Description]**

- (1) STB stores the least significant byte of Rsrc1 in the memory at the address specified by Rsrc2.
- (2) STB stores the least significant byte of Rsrc1 in the memory at the address specified by Rsrc

combined with the 16-bit displacement.

The displacement value is sign-extended to 32 bits before the address calculation.

The condition bit (C) is unchanged.

**[EIT occurrence]**

None

**[Encoding]**

|      |      |      |      |                  |
|------|------|------|------|------------------|
| 0010 | src1 | 0000 | src2 | STB Rsrc1,@Rsrc2 |
| 1010 | src1 | 0000 | src2 | disp16           |

**STB Rsrc1,@(disp16,Rsrc2)**

**STH***load/store instruction***STH****Store halfword****[M32R-FPU Extended Mnemonic]****[Mnemonic]**

- (1) **STH Rsrc1,@Rsrc2**
- (2) **STH Rsrc1,@Rsrc2+ [M32R-FPU Extended Mnemonic]**
- (3) **STH Rsrc1,@(disp16,Rsrc2)**

**[Function]**

Store

- (1) \* ( signed short \*) Rsrc2 = Rsrc1;
- (2) \* ( signed short \*) Rsrc2 = Rsrc1, Rsrc2 += 2 ;
- (3) \* ( signed short \*) ( Rsrc2 + ( signed short ) disp16 ) = Rsrc1;

**[Description]**

- (1) STH stores the least significant halfword of Rsrc1 in the memory at the address specified by Rsrc2.
- (2) STH stores the LSB halfword of Rsrc1 to the memory of the address specified by Rsrc2, and then increments Rsrc2 by 2.
- (3) STH stores the least significant halfword of Rsrc1 in the memory at the address specified by Rsrc combined with the 16-bit displacement. The displacement value is sign-extended to 32 bits before the address calculation.

The condition bit (C) is unchanged.

**[EIT occurrence]**

Address exception (AE)

**[Encoding]**

|      |      |      |      |                   |
|------|------|------|------|-------------------|
| 0010 | src1 | 0010 | src2 | STH Rsrc1,@Rsrc2  |
| 0010 | src1 | 0011 | src2 | STH Rsrc1,@Rsrc2+ |
| 1010 | src1 | 0010 | src2 | disp16            |

**STH Rsrc1,@(disp16,Rsrc2)**

**SUB***arithmetic operation instruction***Subtract****SUB****[Mnemonic]****SUB Rdest,Rsrc****[Function]**

Subtract

 $Rdest = Rdest - Rsrc;$ **[Description]**

SUB subtracts Rsrc from Rdest and puts the result in Rdest.

The condition bit (C) is unchanged.

**[EIT occurrence]**

None

**[Encoding]**

|      |      |      |     |
|------|------|------|-----|
| 0000 | dest | 0010 | src |
|------|------|------|-----|

**SUB Rdest,Rsrc**

**SUBV**

*arithmetic operation instruction*  
**Subtract with overflow checking**

**SUBV****[Mnemonic]**

**SUBV Rdest, Rsrc**

**[Function]**

Subtract

$Rdest = Rdest - Rsrc;$

$C = \text{overflow} ? 1 : 0;$

**[Description]**

SUBV subtracts Rsrc from Rdest and puts the result in Rdest.

The condition bit (C) is set when the subtraction results in overflow; otherwise, it is cleared.

**[EIT occurrence]**

None

**[Encoding]**

|      |      |      |     |      |             |
|------|------|------|-----|------|-------------|
| 0000 | dest | 0000 | src | SUBV | Rdest, Rsrc |
|------|------|------|-----|------|-------------|



**SUBX***arithmetic operation instruction***Subtract with borrow****SUBX****[Mnemonic]****SUBX Rdest, Rsrc****[Function]**

Subtract

 $Rdest = (\text{unsigned}) Rdest - (\text{unsigned}) Rsrc - C;$  $C = \text{borrow} ? 1 : 0;$ **[Description]**

SUBX subtracts Rsrc and C from Rdest and puts the result in Rdest.

The condition bit (C) is set when the subtraction result cannot be represented by a 32-bit unsigned integer; otherwise it is cleared.

**[EIT occurrence]**

None

**[Encoding]**

|      |      |      |     |
|------|------|------|-----|
| 0000 | dest | 0001 | src |
|------|------|------|-----|

**SUBX Rdest, Rsrc**

**TRAP***EIT-related instruction*  
**Trap****TRAP****[Mnemonic]****TRAP #imm4****[Function]**

Trap occurrence  
 BPC = PC + 4;  
 BSM = SM;  
 BIE = IE;  
 BC = C ;  
 IE = 0;  
 C = 0;  
 call\_trap\_handler( imm4 );

**[Description]**

TRAP generates a trap with the trap number specified by the 4-bit immediate value.  
 IE and C bits are cleared to "0".

**[EIT occurrence]**

Trap (TRAP)

**[Encoding]**

|      |      |      |      |                    |
|------|------|------|------|--------------------|
| 0001 | 0000 | 1111 | imm4 | <b>TRAP #imm4;</b> |
|------|------|------|------|--------------------|

**UNLOCK***load/store instruction***Store unlocked****UNLOCK****[Mnemonic]****UNLOCK Rsrc1,@Rsrc2****[Function]**

Store unlocked

```
if (LOCK == 1) { * (int *) Rsrc2 = Rsrc1; }
LOCK = 0;
```

**[Description]**

When the LOCK bit is 1, the contents of Rsrc1 are stored at the memory location specified by Rsrc2. When the LOCK bit is 0, store operation is not executed. The condition bit (C) is unchanged.

This instruction clears the LOCK bit to 0 in addition to the simple storage operation.

The LOCK bit is internal to the CPU and cannot be accessed except by using the LOCK and UNLOCK instructions.

The user cannot directly read or write to this bit.

The LOCK bit is internal to the CPU and is the control bit for receiving all bus right requests from circuits other than the CPU.

Refer to the Users Manual for non-CPU bus right requests, as the handling differs according to the type of M

**[EIT occurrence]**

Address exception (AE)

**[Encoding]**

|      |      |      |      |                     |
|------|------|------|------|---------------------|
| 0010 | src1 | 0101 | src2 | UNLOCK Rsrc1,@Rsrc2 |
|------|------|------|------|---------------------|

**UTOF**

*Floating Point Instructions*  
**Unsigned integer to float**  
**[M32R-FPU Extended Instruction]**

**UTOF****[Mnemonic]**

**UTOF** *Rdest, Rsrc*

**[Function]**

Convert from unsigned integer to floating-point single precision value.

$Rdest = (\text{float}) (\text{unsigned int}) Rsrc ;$

**[Description]**

UTOF converts the 32-bit unsigned integer stored in Rsrc to a floating-point single precision value, and the result is stored in Rdest. The result is rounded according to the RM field in FPSR. The condition bit (C) remains unchanged.

H'0000 0000 is treated as "+0" regardless of the Rounding Mode.

**[EIT occurrence]**

Floating-Point Exceptions (FPE)

- Inexact Exception (IXCT)

**[Encoding]**

|      |            |      |      |      |             |      |      |
|------|------------|------|------|------|-------------|------|------|
| 1101 | <i>src</i> | 0000 | 0000 | 0100 | <i>dest</i> | 0100 | 0000 |
|------|------------|------|------|------|-------------|------|------|

**UTOF** *Rdest, Rsrc*

**XOR***logic operation instruction***Exclusive OR****XOR****[Mnemonic]****XOR Rdest, Rsrc****[Function]**

Exclusive OR

 $Rdest = (\text{unsigned}) Rdest \wedge (\text{unsigned}) Rsrc;$ **[Description]**

XOR computes the logical XOR of the corresponding bits of Rdest and Rsrc, and puts the result in Rdest.

The condition bit (C) is unchanged.

**[EIT occurrence]**

None

**[Encoding]**

|      |      |      |     |
|------|------|------|-----|
| 0000 | dest | 1101 | src |
|------|------|------|-----|

**XOR Rdest, Rsrc**

**XOR3**

*logic operation instruction*  
**Exclusive OR 3-operand**

**XOR3****[Mnemonic]**

```
XOR3 Rdest,Rsrc,#imm16
```

**[Function]**

Exclusive OR

$$Rdest = ( \text{unsigned} ) Rsrc \wedge ( \text{unsigned short} ) \text{imm16};$$
**[Description]**

XOR3 computes the logical XOR of the corresponding bits of Rsrc and the 16-bit immediate value, which is zero-extended to 32 bits, and puts the result in Rdest.

The condition bit (C) is unchanged.

**[EIT occurrence]**

None

**[Encoding]**

|      |      |      |     |       |
|------|------|------|-----|-------|
| 1000 | dest | 1101 | src | imm16 |
|------|------|------|-----|-------|

```
XOR3 Rdest,Rsrc,#imm16
```

# APPENDICES

---

- APPENDIX 1 Hexadecimal Instruction Code
- APPENDIX 2 Instruction List
- APPENDIX 3 Pipeline Processing
- APPENDIX 4 Instruction Execution Time
- APPENDIX 5 IEEE754 Specification Overview
- APPENDIX 6 M32R-FPU Specification Supplemental  
Explanation

### Appendix 1 Hexadecimal Instruction Code

The bit pattern of each instruction and correspondence of mnemonic are shown below. The instructions enclosed in the bold lines are M32R-FPU extended instructions.

Appendix Table 1.1.1 Instruction Code Table

| b8-b11<br>hexadecimal<br>bo-b3 |                  | 0000                                | 0001                               | 0010                                | 0011                         | 0100                               | 0101                          | 0110                                  | 0111                                    |  |
|--------------------------------|------------------|-------------------------------------|------------------------------------|-------------------------------------|------------------------------|------------------------------------|-------------------------------|---------------------------------------|-----------------------------------------|--|
| hexadecimal numeral            |                  | 0                                   | 1                                  | 2                                   | 3                            | 4                                  | 5                             | 6                                     | 7                                       |  |
| 16-bit instruction             | 0000             | <b>SUBV</b><br>Rdest,Rsrc           | <b>SUBX</b><br>Rdest,Rsrc          | <b>SUB</b><br>Rdest,Rsrc            | <b>NEG</b><br>Rdest,Rsrc     | <b>CMP</b><br>Rsrc1,Rsrc2          | <b>CMPU</b><br>Rsrc1,Rsrc2    |                                       |                                         |  |
|                                | 0001             | <b>SRL</b><br>Rdest,Rsrc            |                                    | <b>SRA</b><br>Rdest,Rsrc            |                              | <b>SLL</b><br>Rdest,Rsrc           |                               | <b>MUL</b><br>Rdest,Rsrc              |                                         |  |
|                                | 0010             | <b>STB</b><br>Rsrc1,@Rsrc2          |                                    | <b>STH</b><br>Rsrc1,@Rsrc2          | <b>STH</b><br>Rsrc1,@Rsrc2+  | <b>ST</b><br>Rsrc1,@Rsrc2          | <b>UNLOCK</b><br>Rsrc1,@Rsrc2 | <b>ST</b><br>Rsrc1,@+Rsrc2            | <b>ST</b><br>Rsrc1,@-Rsrc2              |  |
|                                | 0011             | <b>MULHI</b><br>Rsrc1,Rsrc2         | <b>MULLO</b><br>Rsrc1,Rsrc2        | <b>MULWHI</b><br>Rsrc1,Rsrc2        | <b>MULWLO</b><br>Rsrc1,Rsrc2 | <b>MACHI</b><br>Rsrc1,Rsrc2        | <b>MACLO</b><br>Rsrc1,Rsrc2   | <b>MACWHI</b><br>Rsrc1,Rsrc2          | <b>MACWLO</b><br>Rsrc1,Rsrc2            |  |
|                                | 0100             | <b>ADDI</b><br>Rdest,#imm8          |                                    |                                     |                              |                                    |                               |                                       |                                         |  |
|                                | 0101             | <b>SRLI</b><br>Rdest,#imm5          |                                    | <b>SRAI</b><br>Rdest,#imm5          |                              | <b>SLLI</b><br>Rdest,#imm5         |                               |                                       | <b>MVTACHI</b> ,<br><b>MVTACLO</b> (*2) |  |
|                                | 0110             | <b>LDI</b><br>Rdest,#imm8           |                                    |                                     |                              |                                    |                               |                                       |                                         |  |
| 0111                           | <b>NOP</b> (* 1) | <b>BC, BNC, BL, BRA</b>             |                                    |                                     |                              |                                    |                               |                                       | <b>SETPSW, CLRPSW</b> (* 1)             |  |
| 32-bit instruction             | 1000             |                                     |                                    |                                     |                              | <b>CMPI</b><br>Rsrc,#imm16         | <b>CMPUI</b><br>Rsrc,#imm16   |                                       |                                         |  |
|                                | 1001             | <b>DIV</b><br>Rdest,Rsrc            | <b>DIVU</b><br>Rdest,Rsrc          | <b>REM</b><br>Rdest,Rsrc            | <b>REMU</b><br>Rdest,Rsrc    |                                    |                               |                                       |                                         |  |
|                                | 1010             | <b>STB</b><br>Rsrc1,@(disp16,Rsrc2) |                                    | <b>STH</b><br>Rsrc1,@(disp16,Rsrc2) |                              | <b>ST</b><br>Rsrc1,@(disp16,Rsrc2) |                               | <b>BSET</b><br>#bitpos,@(disp16,Rsrc) | <b>BCLR</b><br>#bitpos,@(disp16,Rsrc)   |  |
|                                | 1011             | <b>BEQ</b><br>Rsrc1,Rsrc2,pcdisp16  | <b>BNE</b><br>Rsrc1,Rsrc2,pcdisp16 |                                     |                              |                                    |                               |                                       |                                         |  |
|                                | 1100             | <b>FPU</b><br>extended instruction  |                                    |                                     |                              |                                    |                               |                                       |                                         |  |
|                                | 1110             | <b>LD24</b><br>Rdest,#imm24         |                                    |                                     |                              |                                    |                               |                                       |                                         |  |
|                                | 1111             | <b>BC, BNC, BL, BRA</b> (* 1)       |                                    |                                     |                              |                                    |                               |                                       |                                         |  |

FPU extended instruction (b0-b3 = 1101, b8-b11 = 0000)

| b24-b27<br>hexadecimal<br>b16-b19 |   | 0000         | 0001 | 0010 | 0011 | 0100         | 0101 | 0110 | 0111 |
|-----------------------------------|---|--------------|------|------|------|--------------|------|------|------|
| hexadecimal numeral               |   | 0            | 1    | 2    | 3    | 4            | 5    | 6    | 7    |
| 0000                              | 0 | <b>FADD</b>  |      |      |      | <b>FSUB</b>  |      |      |      |
| 0001                              | 1 | <b>FMUL</b>  |      |      |      |              |      |      |      |
| 0010                              | 2 | <b>FDIV</b>  |      |      |      |              |      |      |      |
| 0011                              | 3 | <b>FMADO</b> |      |      |      | <b>FMSUB</b> |      |      |      |
| 0100                              | 4 | <b>ITOF</b>  |      |      |      | <b>UTOF</b>  |      |      |      |
| 0101                              | 5 |              |      |      |      |              |      |      |      |
| 0110                              | 6 |              |      |      |      |              |      |      |      |
| 0111                              | 7 |              |      |      |      |              |      |      |      |

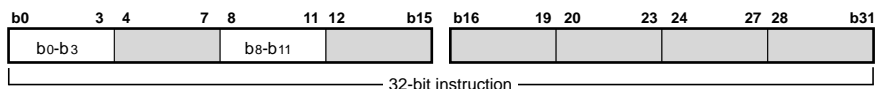
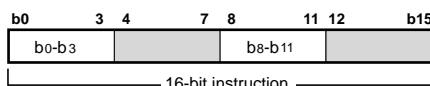



| 1000                               | 1001                                | 1010                               | 1011                                | 1100                              | 1101                             | 1110                            | 1111                                                        | b 8-b11             |         |
|------------------------------------|-------------------------------------|------------------------------------|-------------------------------------|-----------------------------------|----------------------------------|---------------------------------|-------------------------------------------------------------|---------------------|---------|
| 8                                  | 9                                   | A                                  | B                                   | C                                 | D                                | E                               | F                                                           | hexadecimal numeral | b 0-b 3 |
| <b>ADDV</b><br>Rdest,Rsrc          | <b>ADDX</b><br>Rdest,Rsrc           | <b>ADD</b><br>Rdest,Rsrc           | <b>NOT</b><br>Rdest,Rsrc            | <b>AND</b><br>Rdest,Rsrc          | <b>XOR</b><br>Rdest,Rsrc         | <b>OR</b><br>Rdest,Rsrc         | <b>BTST</b><br>#bitpos,Rsrc                                 | 0                   | 0000    |
| <b>MV</b><br>Rdest,Rsrc            | <b>MVFC</b><br>Rdest,CRsrc          | <b>MVTC</b><br>Rsrc,CRdest         |                                     | <b>JL, JMP</b><br>(* 1)           | <b>RTE</b>                       |                                 | <b>TRAP</b><br>#imm4                                        | 1                   | 0001    |
| <b>LDB</b><br>Rdest,@Rsrc          | <b>LDUB</b><br>Rdest,@Rsrc          | <b>LDH</b><br>Rdest,@Rsrc          | <b>LDUH</b><br>Rdest,@Rsrc          | <b>LD</b><br>Rdest,@Rsrc          | <b>LOCK</b><br>Rdest,@Rsrc       | <b>LD</b><br>Rdest,@Rsrc+       |                                                             | 2                   | 0010    |
|                                    |                                     |                                    |                                     |                                   |                                  |                                 |                                                             | 3                   | 0011    |
|                                    |                                     |                                    |                                     | <b>ADDI</b><br>Rdest,#imm8        |                                  |                                 |                                                             | 4                   | 0100    |
| <b>RACH</b>                        | <b>RAC</b>                          |                                    |                                     |                                   |                                  |                                 | <b>MVFACHL</b> ,<br><b>MVFACLQ</b> ,<br><b>MVFACMI</b> (*2) | 5                   | 0101    |
|                                    |                                     |                                    |                                     | <b>LDI</b><br>Rdest,#imm8         |                                  |                                 |                                                             | 6                   | 0110    |
|                                    |                                     |                                    |                                     |                                   |                                  |                                 |                                                             | 7                   | 0111    |
|                                    |                                     |                                    |                                     | <b>BC, BNC, BL, BRA</b> (* 1)     |                                  |                                 |                                                             |                     |         |
| <b>ADDV3</b><br>Rdest,Rsrc,#imm16  |                                     | <b>ADD3</b><br>Rdest,Rsrc,#imm16   |                                     | <b>AND3</b><br>Rdest,Rsrc,#imm16  | <b>XOR3</b><br>Rdest,Rsrc,#imm16 | <b>OR3</b><br>Rdest,Rsrc,#imm16 |                                                             | 8                   | 1000    |
| <b>SRL3</b><br>Rdest,Rsrc,#imm16   |                                     | <b>SRA3</b><br>Rdest,Rsrc,#imm16   |                                     | <b>SLL3</b><br>Rdest,Rsrc,#imm16  |                                  |                                 | <b>LDI</b><br>Rdest,#imm16                                  | 9                   | 1001    |
| <b>LDB</b><br>Rdest,@(disp16,Rsrc) | <b>LDUB</b><br>Rdest,@(disp16,Rsrc) | <b>LDH</b><br>Rdest,@(disp16,Rsrc) | <b>LDUH</b><br>Rdest,@(disp16,Rsrc) | <b>LD</b><br>Rdest,@(disp16,Rsrc) |                                  |                                 |                                                             | A                   | 1010    |
| <b>BEQZ</b><br>Rsrc,pcdisp16       | <b>BNEZ</b><br>Rsrc,pcdisp16        | <b>BLTZ</b><br>Rsrc,pcdisp16       | <b>BGEZ</b><br>Rsrc,pcdisp16        | <b>BLEZ</b><br>Rsrc,pcdisp16      | <b>BGTZ</b><br>Rsrc,pcdisp16     |                                 |                                                             | B                   | 1011    |
|                                    |                                     |                                    |                                     | <b>SETH</b><br>Rdest,#imm16       |                                  |                                 |                                                             | C                   | 1100    |
|                                    |                                     |                                    |                                     | <b>LD24</b><br>Rdest,#imm24       |                                  |                                 |                                                             | D                   | 1101    |
|                                    |                                     |                                    |                                     |                                   |                                  |                                 |                                                             | E                   | 1110    |
|                                    |                                     |                                    |                                     | <b>BC, BNC, BL, BRA</b> (* 1)     |                                  |                                 |                                                             | F                   | 1111    |

| 1000        | 1001 | 1010 | 1011 | 1100        | 1101         | 1110 | 1111 | b24-b27             |         |
|-------------|------|------|------|-------------|--------------|------|------|---------------------|---------|
| 0           | 1    | 2    | 3    | 4           | 5            | 6    | 7    | hexadecimal numeral | b16-b19 |
|             |      |      |      | <b>FCMP</b> | <b>FCMPE</b> |      |      | 0                   | 0000    |
|             |      |      |      |             |              |      |      | 1                   | 0001    |
|             |      |      |      |             |              |      |      | 2                   | 0010    |
|             |      |      |      |             |              |      |      | 3                   | 0011    |
| <b>FTOI</b> |      |      |      | <b>FTOS</b> |              |      |      | 4                   | 0100    |
|             |      |      |      |             |              |      |      | 5                   | 0101    |
|             |      |      |      |             |              |      |      | 6                   | 0110    |
|             |      |      |      |             |              |      |      | 7                   | 0111    |

**Note.** In addition to b0-b3, b8-b11, instructions shown the above \*1, \*2 in the table are decided by the following bit patterns.  
As for details of bit patterns of each instruction, refer to "3.2 Instruction description."  
\*1: b4-b7, \*2: b12-b15

### Appendix 2 Instruction List

The M32R-FPU instruction list is shown below (in alphabetical order).

| mnemonic                    | function                                                                  | condition bit (C) |
|-----------------------------|---------------------------------------------------------------------------|-------------------|
| ADD Rdest,Rsrc              | Rdest = Rdest + Rsrc                                                      | -                 |
| ADD3 Rdest,Rsrc,#imm16      | Rdest = Rsrc + (sh)imm16                                                  | -                 |
| ADDI Rdest,#imm8            | Rdest = Rdest + (sb)imm8                                                  | -                 |
| ADDV Rdest,Rsrc             | Rdest = Rdest + Rsrc                                                      | change            |
| ADDV3 Rdest,Rsrc,#imm16     | Rdest = Rsrc + (sh)imm16                                                  | change            |
| ADDX Rdest,Rsrc             | Rdest = Rdest + Rsrc + C                                                  | change            |
| AND Rdest,Rsrc              | Rdest = Rdest & Rsrc                                                      | -                 |
| AND3 Rdest,Rsrc,#imm16      | Rdest = Rsrc & (uh)imm16                                                  | -                 |
| BC pcdisp8                  | if(C) PC=PC+((sb)pcdisp8<<2)                                              | -                 |
| BC pcdisp24                 | if(C) PC=PC+((s24)pcdisp24<<2)                                            | -                 |
| BCLR #bitpos,@(disp16,Rsrc) | *(sb*)(Rsrc + (sh)disp16) & = ~(1<<(7-bitpos))                            | -                 |
| BEQ Rsrc1,Rsrc2,pcdisp16    | if(Rsrc1 == Rsrc2) PC=PC+((sh)pcdisp16<<2)                                | -                 |
| BEQZ Rsrc,pcdisp16          | if(Rsrc == 0) PC=PC+((sh)pcdisp16<<2)                                     | -                 |
| BGEZ Rsrc,pcdisp16          | if(Rsrc >= 0) PC=PC+((sh)pcdisp16<<2)                                     | -                 |
| BGTZ Rsrc,pcdisp16          | if(Rsrc > 0) PC=PC+((sh)pcdisp16<<2)                                      | -                 |
| BL pcdisp8                  | R14=PC+4,PC=PC+((sb)pcdisp8<<2)                                           | -                 |
| BL pcdisp24                 | R14=PC+4,PC=PC+((s24)pcdisp24<<2)                                         | -                 |
| BLEZ Rsrc,pcdisp16          | if(Rsrc <= 0) PC=PC+((sh)pcdisp16<<2)                                     | -                 |
| BLTZ Rsrc,pcdisp16          | if(Rsrc < 0) PC=PC+((sh)pcdisp16<<2)                                      | -                 |
| BNC pcdisp8                 | if(!C) PC=PC+((sb)pcdisp8<<2)                                             | -                 |
| BNC pcdisp24                | if(!C) PC=PC+((s24)pcdisp24<<2)                                           | -                 |
| BNE Rsrc1,Rsrc2,pcdisp16    | if(Rsrc1 != Rsrc2) PC=PC+((sh)pcdisp16<<2)                                | -                 |
| BNEZ Rsrc,pcdisp16          | if(Rsrc != 0) PC=PC+((sh)pcdisp16<<2)                                     | -                 |
| BRA pcdisp8                 | PC=PC+((sb)pcdisp8<<2)                                                    | -                 |
| BRA pcdisp24                | PC=PC+((s24)pcdisp24<<2)                                                  | -                 |
| BSET #bitpos,@(disp16,Rsrc) | *(sb*)(Rsrc + (sh)disp16)   = (1<<(7-bitpos))                             | -                 |
| BTST #bitpos,Rsrc           | (Rsrc>>(7-bitpos))&1                                                      | change            |
| CLRPSW #imm8                | PSW & = ~imm8   0xfffffff00                                               | change            |
| CMP Rsrc1,Rsrc2             | (s)Rsrc1 < (s)Rsrc2                                                       | change            |
| CMPI Rsrc,#imm16            | (s)Rsrc < (sh)imm16                                                       | change            |
| CMPU Rsrc1,Rsrc2            | (u)Rsrc1 < (u)Rsrc2                                                       | change            |
| CMPUI Rsrc,#imm16           | (u)Rsrc < (u)((sh)imm16)                                                  | change            |
| DIV Rdest,Rsrc              | Rdest = (s)Rdest / (s)Rsrc                                                | -                 |
| DIVU Rdest,Rsrc             | Rdest = (u)Rdest / (u)Rsrc                                                | -                 |
| FADD Rdest,Rsrc1,Rsrc2      | Rdest = Rsrc1 + Rsrc2                                                     | -                 |
| FCMP Rdest,Rsrc1,Rsrc2      | Rdest = (Rsrc1 == Rsrc2)?32'h00000000:((Rsrc1<Rsrc2)?{1.31'bx}:{0.31'bx}) | -                 |
| FCMPE Rdest,Rsrc1,Rsrc2     | FCMP with Exception when unordered                                        | -                 |
| FDIV Rdest,Rsrc1,Rsrc2      | Rdest = Rsrc1 / Rsrc2                                                     | -                 |

| mnemonic                  | function                                                      | condition bit (C) |
|---------------------------|---------------------------------------------------------------|-------------------|
| FMADD Rdest,Rsrc1,Rsrc2   | Rdest = Rdest + Rsrc1 * Rsrc2                                 | -                 |
| FMSUB Rdest,Rsrc1,Rsrc2   | Rdest = Rdest - Rsrc1 * Rsrc2                                 | -                 |
| FMUL Rdest,Rsrc1,Rsrc2    | Rdest = Rdest * Rsrc2                                         | -                 |
| FSUB Rdest,Rsrc1,Rsrc2    | Rdest = Rsrc1 - Rsrc2                                         | -                 |
| FTOI Rdest,Rsrc           | Rdest = (s)Rsrc2                                              | -                 |
| FTOS Rdest,Rsrc           | Rdest = (sh)Rsrc                                              | -                 |
| ITOF Rdest,Rsrc           | Rdest = (float)Rsrc                                           | -                 |
| JL Rsrc                   | R14 = PC+4, PC = Rsrc                                         | -                 |
| JMP Rsrc                  | PC = Rsrc                                                     | -                 |
| LD Rdest,@(disp16,Rsrc)   | Rdest = *(s*)(Rsrc+(sh)disp16)                                | -                 |
| LD Rdest,@Rsrc            | Rdest = *(s*)Rsrc                                             | -                 |
| LD Rdest,@Rsrc+           | Rdest = *(s*)Rsrc, Rsrc += 4                                  | -                 |
| LD24 Rdest,#imm24         | Rdest = imm24 & 0x00ffffff                                    | -                 |
| LDB Rdest,@(disp16,Rsrc)  | Rdest = *(sb*)(Rsrc+(sh)disp16)                               | -                 |
| LDB Rdest,@Rsrc           | Rdest = *(sb*)Rsrc                                            | -                 |
| LDH Rdest,@(disp16,Rsrc)  | Rdest = *(sh*)(Rsrc+(sh)disp16)                               | -                 |
| LDH Rdest,@Rsrc           | Rdest = *(sh*)Rsrc                                            | -                 |
| LDI Rdest,#imm16          | Rdest = (sh)imm16                                             | -                 |
| LDI Rdest,#imm8           | Rdest = (sb)imm8                                              | -                 |
| LDUB Rdest,@(disp16,Rsrc) | Rdest = *(ub*)(Rsrc+(sh)disp16)                               | -                 |
| LDUB Rdest,@Rsrc          | Rdest = *(ub*)Rsrc                                            | -                 |
| LDUH Rdest,@(disp16,Rsrc) | Rdest = *(uh*)(Rsrc+(sh)disp16)                               | -                 |
| LDUH Rdest,@Rsrc          | Rdest = *(ub*)Rsrc                                            | -                 |
| LOCK Rdest,@Rsrc          | LOCK = 1, Rdest = *(s*)Rsrc                                   | -                 |
| MACHI Rsrc1,Rsrc2         | accumulator += (s)(Rsrc1 & 0xffff0000)<br>* (s)((s)Rsrc2>>16) | -                 |
| MACLO Rsrc1,Rsrc2         | accumulator += (s)(Rsrc1<<16) * (sh)Rsrc2                     | -                 |
| MACWHI Rsrc1,Rsrc2        | accumulator += (s)Rsrc1 * (s)((s)Rsrc2>>16)                   | -                 |
| MACWLO Rsrc1,Rsrc2        | accumulator += (s)Rsrc1 * (sh)Rsrc2                           | -                 |
| MUL Rdest,Rsrc            | Rdest = (s)Rdest * (s)Rsrc                                    | -                 |
| MULHI Rsrc1,Rsrc2         | accumulator = (s)(Rsrc1 & 0xffff0000)<br>* (s)((s)Rsrc2>>16)  | -                 |
| MULLO Rsrc1,Rsrc2         | accumulator = (s)(Rsrc1<<16) * (sh)Rsrc2                      | -                 |
| MULWHI Rsrc1,Rsrc2        | accumulator = (s)Rsrc1 * (s)((s)Rsrc2>>16)                    | -                 |
| MULWLO Rsrc1,Rsrc2        | accumulator = (s)Rsrc1 * (sh)Rsrc2                            | -                 |
| MV Rdest,Rsrc             | Rdest = Rsrc                                                  | -                 |
| MVFACHI Rdest             | Rdest = accumulator >> 32                                     | -                 |
| MVFACLO Rdest             | Rdest = accumulator                                           | -                 |
| MVFACMI Rdest             | Rdest = accumulator >> 16                                     | -                 |
| MVFC Rdest,CRsrc          | Rdest = CRsrc                                                 | -                 |
| MVTACHI Rsrc              | accumulator[0:31] = Rsrc                                      | -                 |
| MVTACLO Rsrc              | accumulator[32:63] = Rsrc                                     | -                 |
| MVTC Rsrc,CRdest          | CRdest = Rsrc                                                 | change            |

| mnemonic                  | function                                                                                   | condition bit (C) |
|---------------------------|--------------------------------------------------------------------------------------------|-------------------|
| NEG Rdest,Rsrc            | Rdest = 0 - Rsrc                                                                           | -                 |
| NOP                       | /*no-operation*/                                                                           | -                 |
| NOT Rdest,Rsrc            | Rdest = ~Rsrc                                                                              | -                 |
| OR Rdest,Rsrc             | Rdest = Rdest   Rsrc                                                                       | -                 |
| OR3 Rdest,Rsrc,#imm16     | Rdest = Rsrc   (uh)imm16                                                                   | -                 |
| RAC                       | Round the 32-bit value in the accumulator                                                  | -                 |
| RACH                      | Round the 16-bit value in the accumulator                                                  | -                 |
| REM Rdest,Rsrc            | Rdest = (s)Rdest % (s)Rsrc                                                                 | -                 |
| REMU Rdest,Rsrc           | Rdest = (u)Rdest % (u)Rsrc                                                                 | -                 |
| RTE                       | PC = BPC & 0xfffffff, PSW[SM,IE,C] = PSW[BSM,BIE,BC]                                       | change            |
| SETH Rdest,#imm16         | Rdest = imm16 << 16                                                                        | -                 |
| SETPSW #imm8              | PSW   = imm8&0x000000ff                                                                    | change            |
| SLL Rdest,Rsrc            | Rdest = Rdest << (Rsrc & 31)                                                               | -                 |
| SLL3 Rdest,Rsrc,#imm16    | Rdest = Rsrc << (imm16 & 31)                                                               | -                 |
| SLLI Rdest,#imm5          | Rdest = Rdest << imm5                                                                      | -                 |
| SRA Rdest,Rsrc            | Rdest = (s)Rdest >> (Rsrc & 31)                                                            | -                 |
| SRA3 Rdest,Rsrc,#imm16    | Rdest = (s)Rsrc >> (imm16 & 31)                                                            | -                 |
| SRAI Rdest,#imm5          | Rdest = (s)Rdest >> imm5                                                                   | -                 |
| SRL Rdest,Rsrc            | Rdest = (u)Rdest >> (Rsrc & 31)                                                            | -                 |
| SRL3 Rdest,Rsrc,#imm16    | Rdest = (u)Rsrc >> (imm16 & 31)                                                            | -                 |
| SRLI Rdest,#imm5          | Rdest = (u)Rdest >> imm5                                                                   | -                 |
| ST Rsrc1,@(disp16,Rsrc2)  | *(s*)(Rsrc2+(sh)disp16) = Rsrc1                                                            | -                 |
| ST Rsrc1,@+Rsrc2          | Rsrc2 += 4, *(s*)Rsrc2 = Rsrc1                                                             | -                 |
| ST Rsrc1,@-Rsrc2          | Rsrc2 -= 4, *(s*)Rsrc2 = Rsrc1                                                             | -                 |
| ST Rsrc1,@Rsrc2           | *(s*)Rsrc2 = Rsrc1                                                                         | -                 |
| STB Rsrc1,@(disp16,Rsrc2) | *(sb*)(Rsrc2+(sh)disp16) = Rsrc1                                                           | -                 |
| STB Rsrc1,@Rsrc2          | *(sb*)Rsrc2 = Rsrc1                                                                        | -                 |
| STH Rsrc1,@(disp16,Rsrc2) | *(sh*)(Rsrc2+(sh)disp16) = Rsrc1                                                           | -                 |
| STH Rsrc1,@Rsrc2          | *(sh*)Rsrc2 = Rsrc1                                                                        | -                 |
| STH Rsrc1,@Rsrc2+         | *(sh*)Rsrc2 = Rsrc1, Rsrc2 += 2                                                            | -                 |
| SUB Rdest,Rsrc            | Rdest = Rdest - Rsrc                                                                       | -                 |
| SUBV Rdest,Rsrc           | Rdest = Rdest - Rsrc                                                                       | change            |
| SUBX Rdest,Rsrc           | Rdest = Rdest - Rsrc - C                                                                   | change            |
| TRAP #n                   | PSW[BSM,BIE,BC] = PSW[SM,IE,C]<br>PSW[SM,IE,C] = PSW[SM,0,0]<br>Call trap-handler number-n | change            |
| UNLOCK Rsrc1,@Rsrc2       | if(LOCK) { *(s*)Rsrc2 = Rsrc1; } LOCK=0                                                    | -                 |
| UTOF Rdest,Rsrc           | Rdest = (float)(unsigned int) Rsrc;                                                        | -                 |
| XOR Rdest,Rsrc            | Rdest = Rdest ^ Rsrc                                                                       | -                 |
| XOR3 Rdest,Rsrc,#imm16    | Rdest = Rsrc ^ (uh)imm16                                                                   | -                 |

where:

```
typedef signed int s; /* 32 bit signed integer (word)*/
typedef unsigned int u; /* 32 bit unsigned integer (word)*/
typedef signed short sh; /* 16 bit signed integer (halfword)*/
typedef unsigned short uh; /* 16 bit unsigned integer (halfword)*/
typedef signed char sb; /* 8 bit signed integer (byte)*/
typedef unsigned char ub; /* 8 bit unsigned integer (byte)*/
```

### Appendix 3 Pipeline Processing

#### Appendix 3.1 Instructions and Pipeline Processing

Appendix Figure 3.1.1 shows each instruction type and the pipeline process.

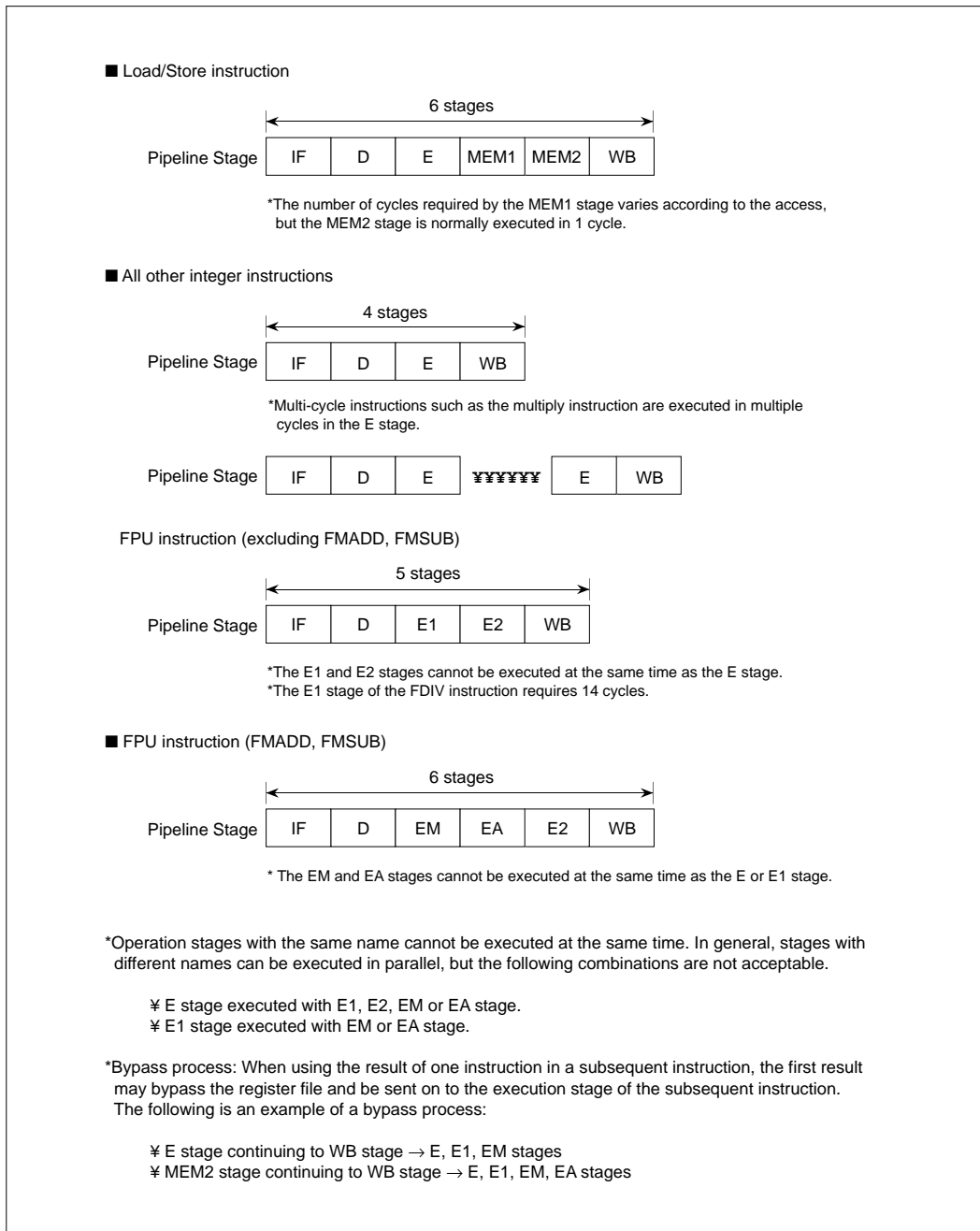

Appendix Figure 3.1.1 Instructions and Pipeline Process

The overview of each pipeline stage is shown below.

- IF stage (instruction fetch stage)

The instruction fetch (IF) is processed in this stage. There is an instruction queue and instructions are fetched until the queue is full regardless of the completion of decoding in the D stage.

If there is an instruction already in the instruction queue, the instruction read out of the instruction queue is passed to the instruction decoder.

- D stage (decode stage)

Instruction decoding is processed in the first half of the D stage (DEC1).

The subsequent instruction decoding (DEC2) and a register fetch (RF) is processed in the second half of the stage.

- E stage (execution stage)

Operations and address calculations (OP) are processed in the E stage.

If an operation result from the previous instruction is required, bypass process (BYP) is performed in the first half of the E stage.

- E1, EM, EA stage (execution stage)

These are the initial stages for execution of the FPU instructions. The EM and EA stages only use instructions FMADD and FMSUB. All other instructions are used in the E1stage

- E2 stage (execution stage)

This is the secondary stage for the execution of FPU instructions and mainly rounding is performed.

- MEM stage (memory access stage)

Operand accesses (OA) are processed in the MEM stage. This stage is used only when the load/store instruction is executed.

- WB stage (write back stage)

The operation results and fetched data are written to the registers in the WB stage.

### Appendix 3.2 Pipeline Basic Operation

#### (1) Pipeline Flow with no Stall

The following diagram shows an ideal pipeline flow that has no stall and executes each instruction in 1 clock cycle. (Since this is just an ideal case, all instructions may not be piplined in.)

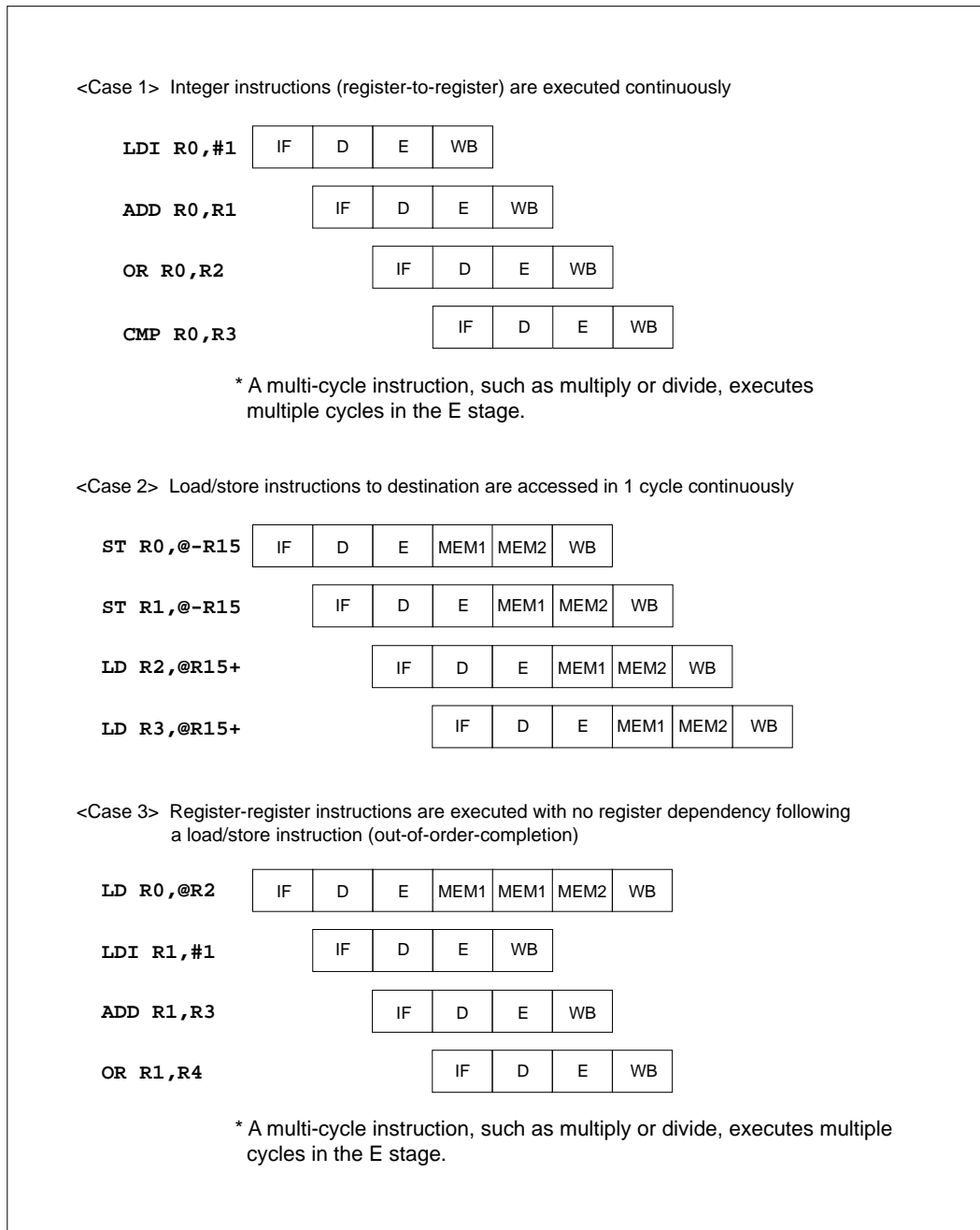

Appendix Figure 3.2.1 Pipeline Flow with no Stall (1)



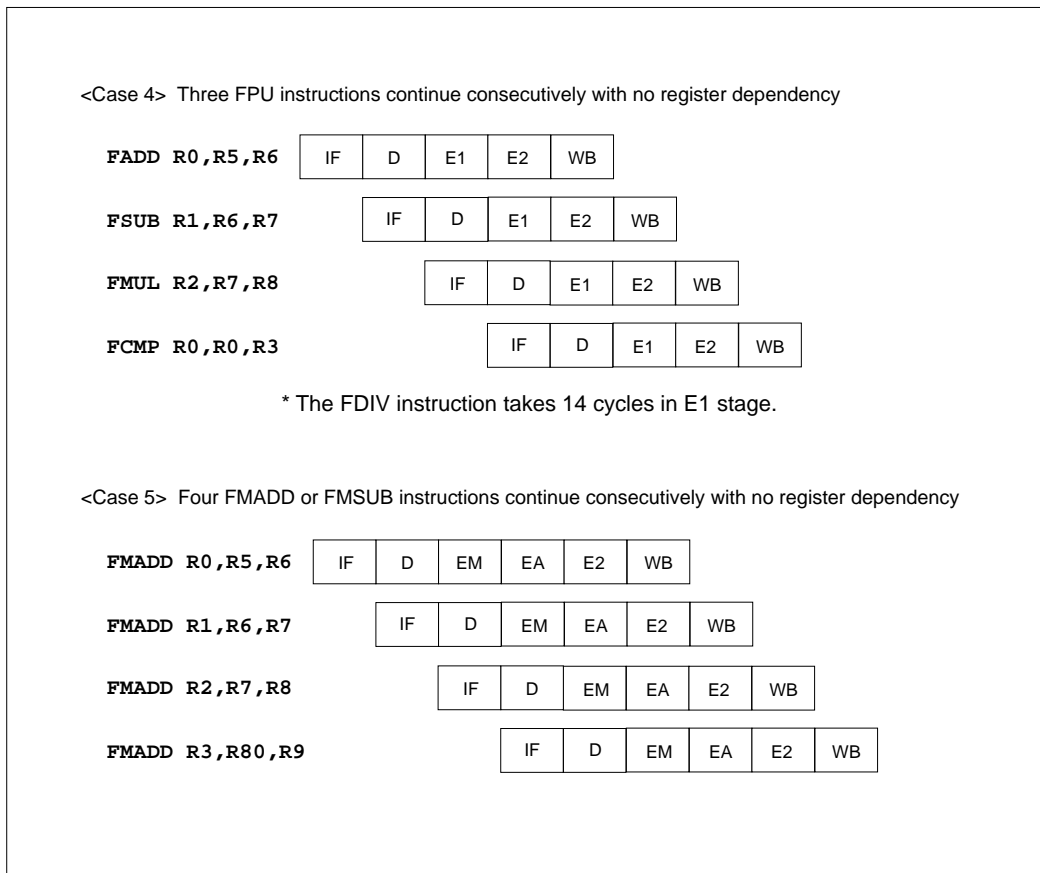

Appendix Figure 3.2.2 Pipeline Flow with no Stall (2)

### (2) Pipeline Flow with Stalls

A pipeline stage may stall due to execution of a process or branch instruction. The following diagrams show typical stall cases.

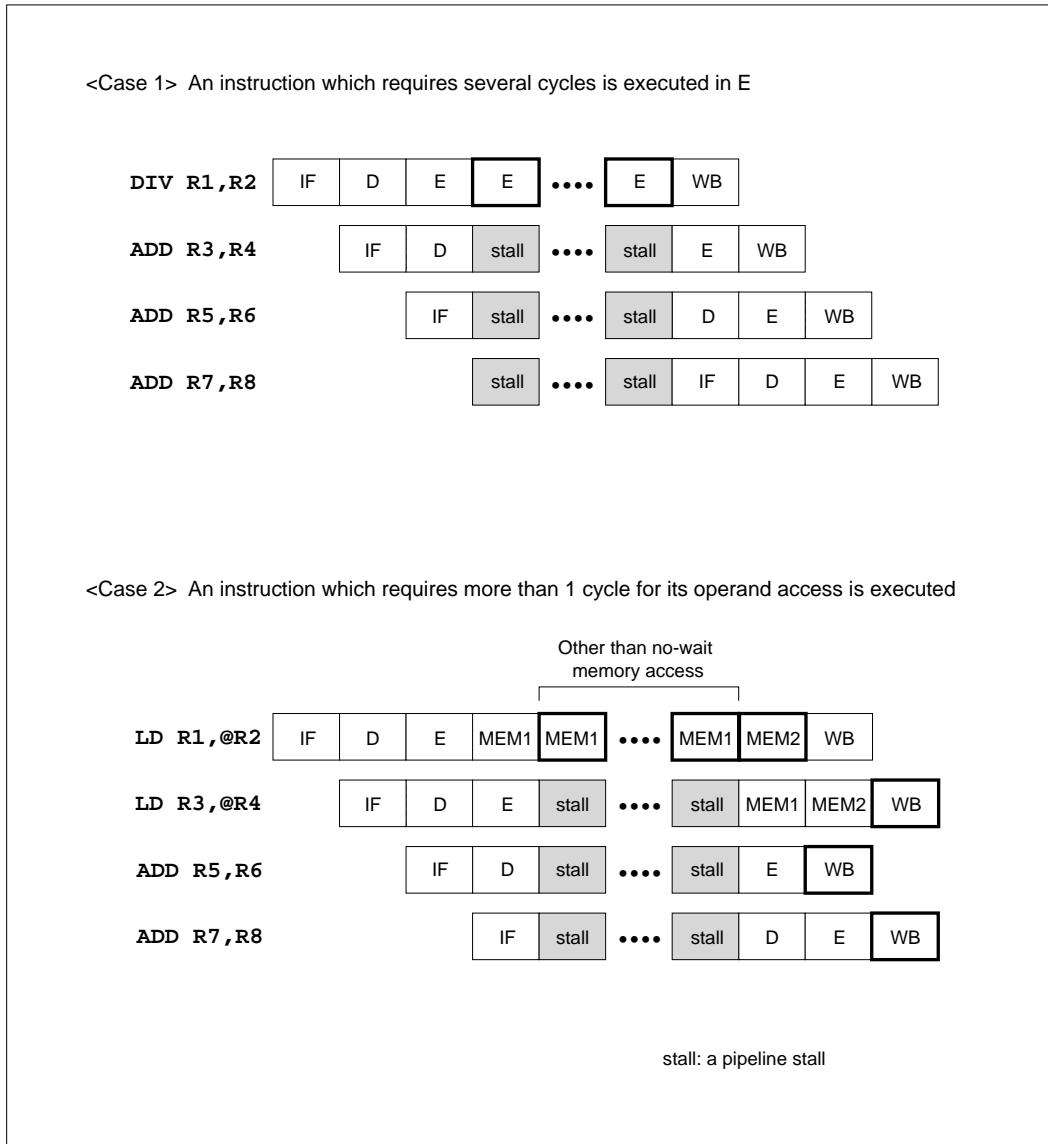

Appendix Figure 3.2.3 Pipeline Flow with Stalls (1)

<Case 3> A branch instruction is executed (except for the case in which no branch occurs at a conditional branch instruction)

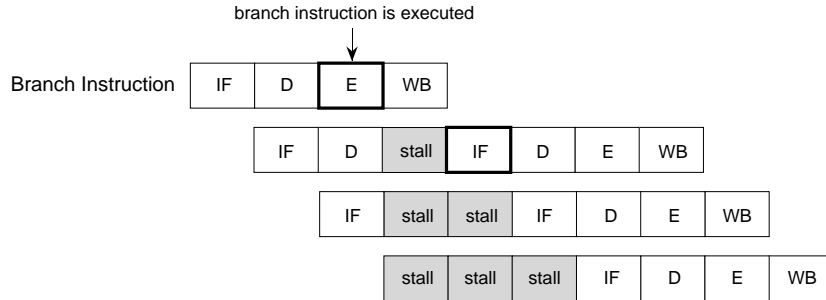

<Case 4> The subsequent instruction uses an operand read from the memory

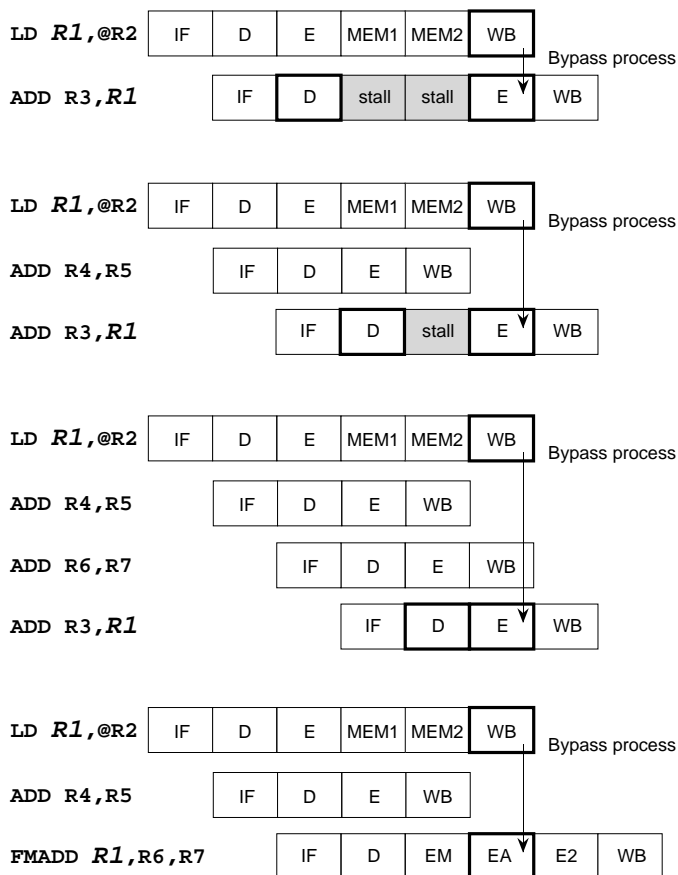

Appendix Figure 3.2.4 Pipeline Flow with Stalls (2)

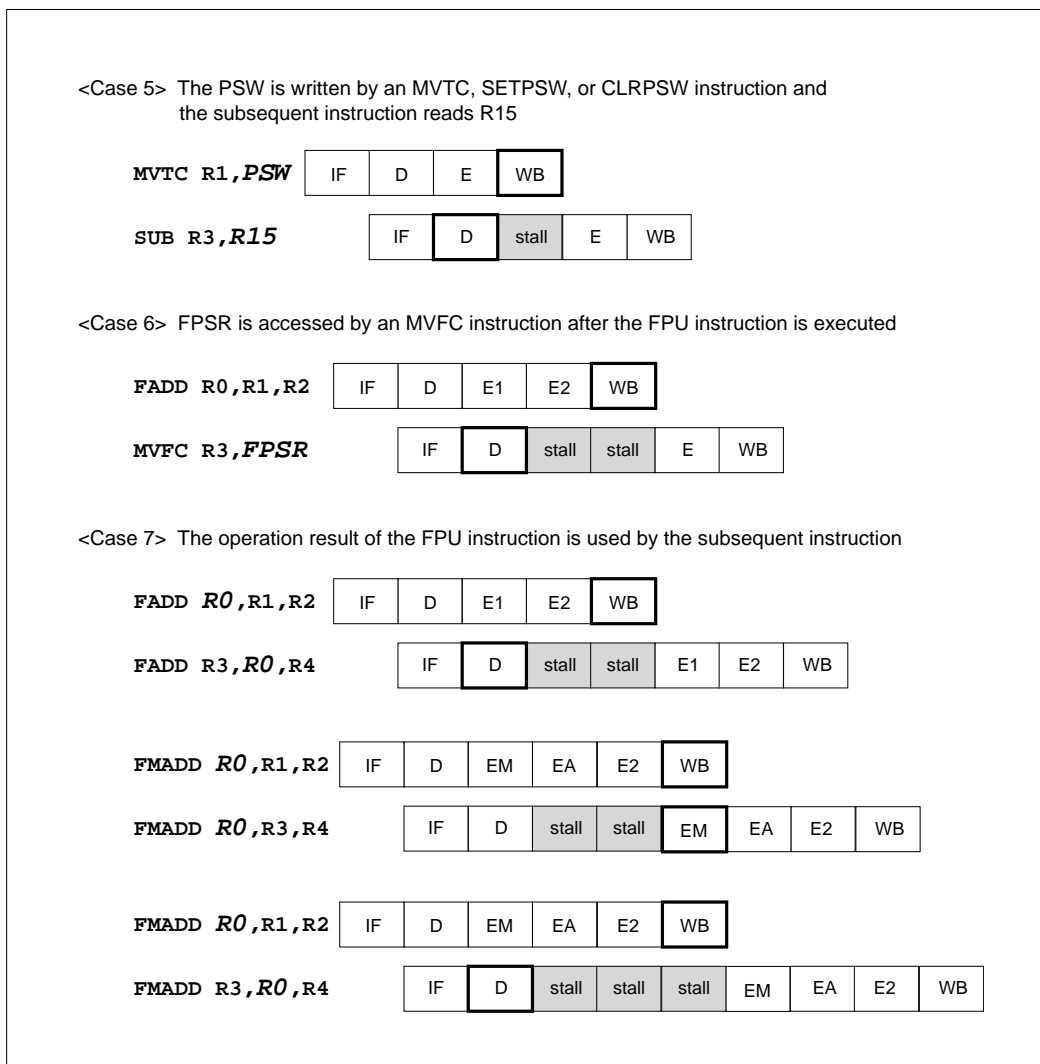

Appendix Figure 3.2.5 Pipeline Flow with Stalls (3)

<Case 8> The FPU and integer instructions run consecutively (with no register dependency)

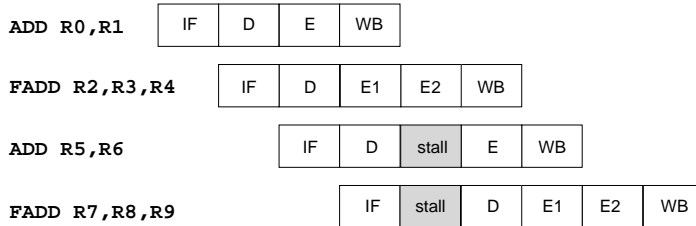

<Case 9> The FPU and integer instructions run consecutively (with register dependency)

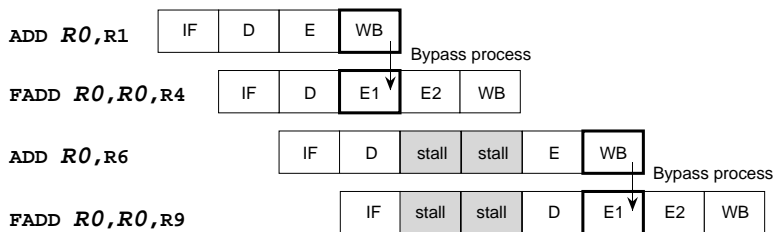

<Case 10> The FMADD/FMSUB instructions run consecutively with the integer instruction (with no register dependency)

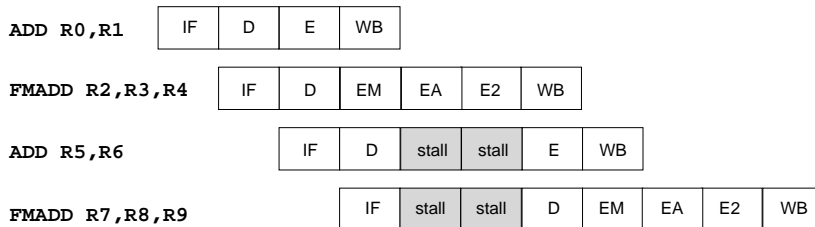

<Case 11> The FMADD/FMSUB instructions run consecutively with the integer instruction (with register dependency)

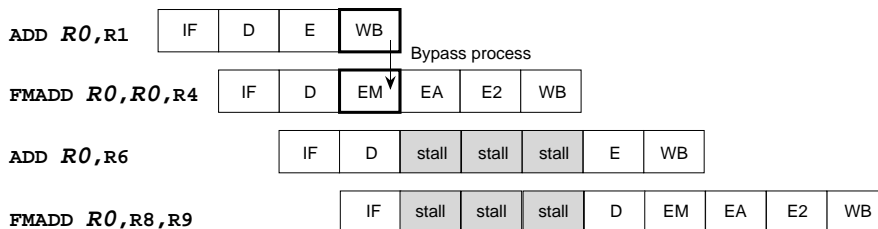

Appendix Figure 3.2.6 Pipeline Flow with Stalls (4)

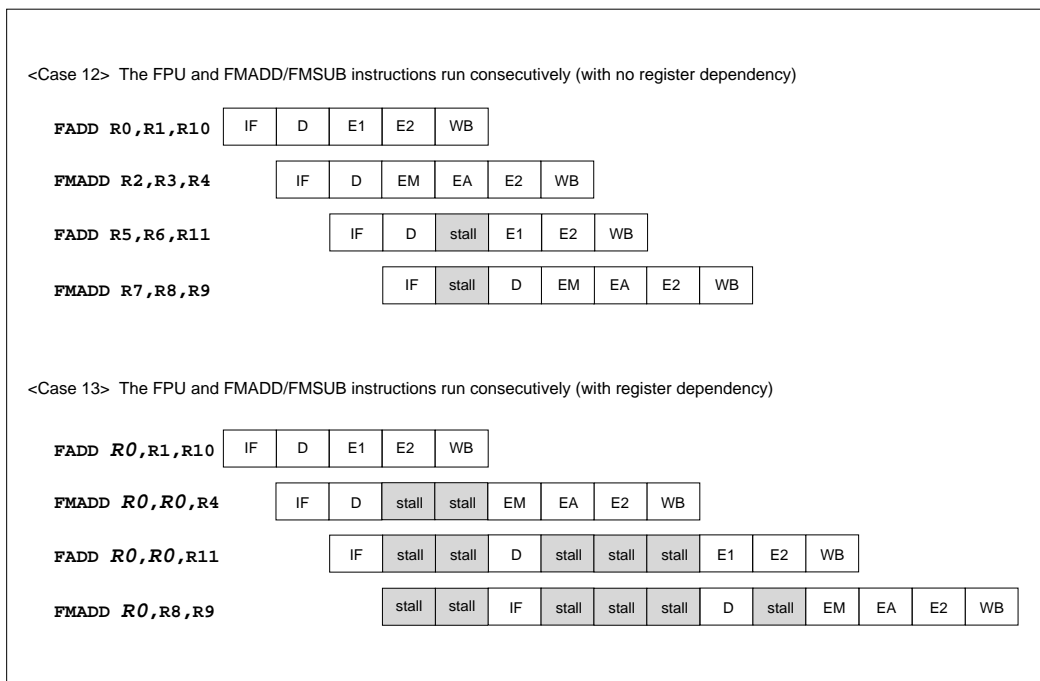

Appendix Figure 3.2.7 Pipeline Flow with Stalls (5)

#### Appendix 4 Instruction Execution Time

Normally, the E stage is considered as representing as the instruction execution time, however, because of the pipeline processing the execution time for other stages may effect the total instruction execution time. In particular, the IF, D, and E stages of the subsequent instruction must be considered after a branch has occurred.

The following shows the number of the instruction execution cycles for each pipeline stage.

The execution time of the IF and MEM stages depends on the implementation of each product of the M32R family.

Refer to the user's manual of each product for the execution time of these stages.

**Note 1: FPU instruction uses E1 and EM stages.**

Appendix Table 4.1.1 Instruction Execution Cycles per Pipeline Stage [excluding FPU instructions]

| instruction                                                                    | the number of execution cycles in each stage |   |                  |            |      |              |
|--------------------------------------------------------------------------------|----------------------------------------------|---|------------------|------------|------|--------------|
|                                                                                | IF                                           | D | E                | MEM1       | MEM2 | WB           |
| load instruction (LD, LDB, LDUB, LDH, LDUH, LOCK)                              | R (note 1)                                   | 1 | 1                | R (note 1) | 1    | 1            |
| store instruction (ST, STB, STH, UNLOCK)                                       | R (note 1)                                   | 1 | 1                | W (note 1) | 1    | (1) (note 2) |
| BSET, BCLR instructions                                                        | R (note 1)                                   | 1 | R (note 1)<br>+3 | W (note 1) | 1    | -            |
| multiply instruction (MUL)                                                     | R (note 1)                                   | 1 | 3                | -          | -    | 1            |
| divide/remainder instruction (DIV, DIVU, REM, REMU)                            | R (note 1)                                   | 1 | 37               | -          | -    | 1            |
| other instructions (DSP function instructions, including BTST, SETPSW, CLRPSW) | R (note 1)                                   | 1 | 1                | -          | -    | 1            |

**Note 1:** R, W: Refer to the user's manual prepared for each product.

**Note 2:** Within the store instruction, only instructions which include the register indirect and register update addressing mode require 1 cycle in the WB stage. All other instructions do not require extra cycles.

Appendix Table 4.1.2 Instruction Execution Cycles per Pipeline Stage [FPU instructions]

| instruction               | the number of execution cycles in each stage |   |    |    |    |    |    |
|---------------------------|----------------------------------------------|---|----|----|----|----|----|
|                           | IF                                           | D | E1 | EM | EA | E2 | WB |
| FMADD, FMSUB instructions | R (note 1)                                   | 1 | -  | 1  | 1  | 1  | 1  |
| FDIV instruction          | R (note 1)                                   | 1 | 14 | -  | -  | 1  | 1  |
| other FPU instructions    | R (note 1)                                   | 1 | 1  | -  | -  | 1  | 1  |

**Note 1:** R, W: Refer to the user's manual prepared for each product.

## Appendix 5 IEEE754 Specification Overview

The following is a basic overview of the IEEE754 specification. M32R-FPU fulfills the IEEE754 requirements through a combination of software and hardware features.

### Appendix 5.1 Floating Point Formats

The following describes the floating-point formats.

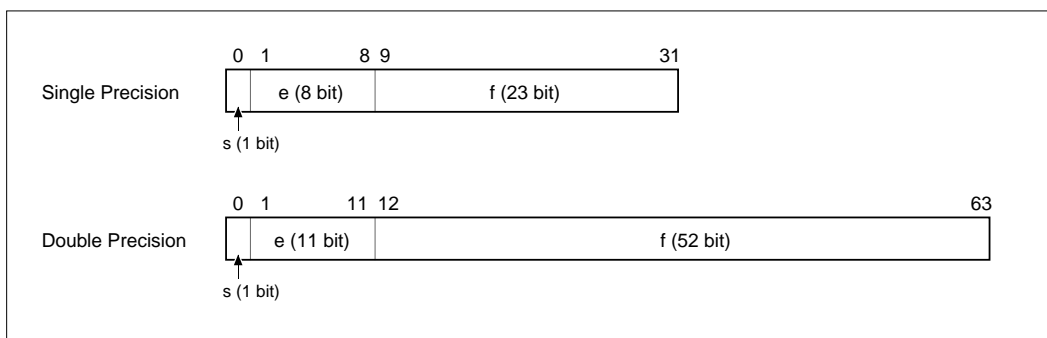

Appendix Figure 5.1.1 Floating-Point Formats

s: Sign bit. 0 = positive number, 1 = negative numbers

e: Exponent. This represents a value that was made positive by adding 127 to a single precision value or 1023 to a double precision value (biased exponent).

f: Fraction. Represents the fraction field of the value.

Using these symbols, the floating-point values (normalized numbers) can be described by the following expressions:

**Single-Precision Format:**  $(-1)^s \times 1.f \times 2^{(e-127)}$

**Double-Precision Format:**  $(-1)^s \times 1.f \times 2^{(e-1023)}$

- Certain values do not fit into the above expressions, such as  $\pm\infty$ ,  $\pm 0$ , NaN (Not a Number), denormalized numbers, etc.
- Other formats, such as expanded double precision, can also be used.

★ M32R-FPU only supports the single-precision format. The double precision format is supported in the software library.



Appendix Table 5.1.1 Single Precision Floating-Point Bit Values

| Exponent            |                                   | Expressed value                                                                                                                                                                |
|---------------------|-----------------------------------|--------------------------------------------------------------------------------------------------------------------------------------------------------------------------------|
| Before adding bias  | After adding bias<br>(=0111 1111) |                                                                                                                                                                                |
| 0111 1111 (+127)    | 1111 1110                         | Normalized number<br>(The absolute value can be described for the range<br>of $1.0...0 \times 2^{-126}$ to $1.1...1 \times 2^{127}$ )                                          |
| • • •               | • • •                             |                                                                                                                                                                                |
| 1000 0010 (-126)    | 0000 0001                         | Fraction field = all 0: $\pm 0$<br>Fraction field $\neq$ all 0: denormalized number                                                                                            |
| (1000 0001 (-127) ) | 0000 0000                         |                                                                                                                                                                                |
| (1000 0000 (-128) ) | 1111 1111                         | Fraction field = all 0: $\pm\infty$<br>Fraction field $\neq$ all 0: NaN (the value is split into SNaN and QNaN according to the value of high-order bit of the fraction field) |

#### (1) Denormalized Numbers

Denormalized numbers represent numbers (values??) that have an absolute value less than  $1.0...0 \times 2^{-126}$ . Single-precision denormalized numbers are expressed as follows:

$$(-1)^s \times 0.f \times 2^{-126}$$

#### (2) NaN (Not a Number)

**SNaN (Signaling NaN):** a NaN in which the MSB of the decimal fraction field is "0". When SNaN is used as the source operand in an operation, an IVLD occurs. SNaNs are useful in identifying program bugs when used as the initial value in a variable. However, SNaNs cannot be generated by hardware.

**QNaN (Quiet NaN):** a NaN in which the MSB of the decimal fraction field is "1". Even when QNaN is used as the source operand in an operation, an IVLD will not occur (excluding comparison and format conversion). Because a result can be checked by the arithmetic operations, QNaN allows the user to debug without executing an EIT processing. QNaNs are created by hardware.

#### Appendix 5.2 Rounding

The following 4 rounding modes are specified by IEEE754.

Appendix Table 5.2.1 Four Rounding Modes

| Rounding Mode              | Operation                                                                                                                                      |
|----------------------------|------------------------------------------------------------------------------------------------------------------------------------------------|
| Round to Nearest (default) | Assuming an infinite range of precision, round to the best approximation of the result. Round an interval arithmetic result to an even number. |
| Round toward -Infinity     | Round to the smaller magnitude of the result.                                                                                                  |
| Round toward +Infinity     | Round to the larger magnitude of the result.                                                                                                   |
| Round toward 0             | Round to the smaller in magnitude of the absolute value of the result.                                                                         |

- “Round to Nearest” is the default mode and produces the most accurate value.
- “Round toward -Infinity,” “Round toward +Infinity” and “Round toward Zero” are used for interval arithmetic to insure precision

#### Appendix 5.3 Exceptions

IEEE754 allows the following 5 exceptions. The floating-point status register is used to determine whether the EIT process will be executed when an Exception occurs.

##### (1) Overflow Exception (OVF)

The exception occurs when the absolute value of the operation result exceeds the largest describable precision in the floating-point format. Appendix Table 5.3.1 shows the operation results when an OVF occurs.

Appendix Table 5.3.1 Operation Result due to OVF Exception

| Rounding Mode | Sign of Result | Result                                |                                                                                  |
|---------------|----------------|---------------------------------------|----------------------------------------------------------------------------------|
|               |                | when the OVF EIT processing is masked | when the OVF EIT processing is executed                                          |
| -Infinity     | +              | +MAX                                  | round ( $x2^{-a}$ )<br>a = 192 (single-precision)<br>a = 1536 (double-precision) |
|               | -              | -Infinity                             |                                                                                  |
| +Infinity     | +              | +Infinity                             |                                                                                  |
|               | -              | -MAX                                  |                                                                                  |
| 0             | +              | +MAX                                  |                                                                                  |
|               | -              | -MAX                                  |                                                                                  |
| Nearest       | +              | +Infinity                             |                                                                                  |
|               | -              | -Infinity                             |                                                                                  |

- Note :**
- When the Underflow Exception Enable (EU) bit (FPSR register bit 18) = "0"
  - When the Underflow Exception Enable (EU) bit (FPSR register bit 18) = "1"

#### (2) Underflow Exception (UDF)

The exception occurs when the absolute value of the operation result is less than the largest describable precision in the floating-point format. Appendix Table 5.3.2 shows the operation results when a UDF occurs.

Appendix Table 5.3.2 Operation Results due to UDF Exception

| Result                                                                           |                                                                                |
|----------------------------------------------------------------------------------|--------------------------------------------------------------------------------|
| when the UDF EIT processing is masked                                            | when the UDF EIT processing is executed                                        |
| Denormalized Numbers<br>(The denormalize flag is set only when rounding occurs.) | round ( $x2^a$ )<br>a = 192 (single-precision),<br>a = 1536 (double-precision) |

**Note:** • When the operation result is rounded, an Inexact Exception is generated simultaneously.

#### (3) Inexact Exception (IXCT)

The exception occurs when the operation result differs from a result led out with an infinite range of precision. Appendix Table 5.3.3 shows operation results and the respective conditions in which each IXCT occurs.

Appendix Table 5.3.3 Operation Results and Respective Conditions for IXCT Exception

| Occurrence Condition                              | Result                                 |                                          |
|---------------------------------------------------|----------------------------------------|------------------------------------------|
|                                                   | when the IXCT EIT processing is masked | when the IXCT EIT processing is executed |
| Overflow occurs in OVF Exception masked condition | Reference OVF Exception table          | Same as left                             |
| Rounding occurs                                   | Rounded value                          | Same as left                             |

#### (4) Zero Division Exception (DIV0)

The exception occurs when a finite, nonzero value is divided by zero. Appendix Table 5.3.4 shows the operation result when a DIV0 occurs.

Appendix Table 5.3.4 Operation Results for DIV0 Exception

| Dividend             | Result                                                                                   |                                          |
|----------------------|------------------------------------------------------------------------------------------|------------------------------------------|
|                      | when the DIV0 EIT processing is masked                                                   | when the IXCT EIT processing is executed |
| Nonzero finite value | $\pm$ Infinity (Sign of result is exclusive-OR (EXOR) of signs of divider and dividend.) | Destination unchanged                    |

Please note that the DIV0 EIT operation does not occur in the following factors.

| Dividend | Operation                                  |
|----------|--------------------------------------------|
| 0        | Invalid Operation Exception occurs         |
| Infinity | No Exception occurs (result is "Infinity") |

#### (5) Invalid Operation Exception (IVLD)

The exception occurs when an invalid operation is executed. Appendix Table 5.3.5 shows operation results and the respective conditions in which each IVLD occurs.

Appendix Table 5.3.5 Operation Results due to IVLD Exception

| Occurrence Condition                                                | Result                                 |                                          |
|---------------------------------------------------------------------|----------------------------------------|------------------------------------------|
|                                                                     | when the IVLD EIT processing is masked | when the IVLD EIT processing is executed |
| Operation for SNaN operand                                          | QNaN                                   | (Destination unchanged)                  |
| +Infinity– (+Infinity), –Infinity– (–Infinity)                      |                                        |                                          |
| 0 X Infinity                                                        |                                        |                                          |
| 0 ÷ 0, Infinity ÷ Infinity                                          |                                        |                                          |
| oute operation for values less then 0                               |                                        |                                          |
| Integer conversion overflow:<br>NaN and ∞ are converted to integers | Undefined                              |                                          |
| When < or > comparison was performed on NaN                         | (No change)                            |                                          |

Important: The following operations never generate an Exception.

$\sqrt{-0}$ : returns  $-0$

$\infty / 0$ : returns  $\infty$  (Sign of result is exclusive-OR (EXOR) of signs of divider and dividend.)

#### ■ Definition of Terms

##### • Exception

Special conditions generated by execution of floating-point instructions. The corresponding enable bits of the floating-point status register are used to determine whether the EIT processing will be executed when an Exception occurs. However, the actual generation of an exception cannot be masked.

##### • EIT Processing

An operation triggered by the generation of an Exception, in which the flow jumps to a floating-point Exception vector address, or a string of related Exception operation sequences is triggered. The corresponding enable bits of the floating-point status register are used to determine whether the EIT processing will be executed when an Exception occurs.

##### • Intermediate Result of Operation

The value resulting from calculations of infinite and unbounded exponent and mantissa bits. In actual implementation, the number of exponent and mantissa bits is finite and the intermediate result is rounded so that the final operation result can be determined.

## Appendix 6 M32R-FPU Specification Supplemental Explanation

### Appendix 6.1 Operation Comparison: Using 1 instruction (FMADD or FMSBU) vs. two instructions (FMUL and FADD)

The following is an explanation of the differences between an operation using just one instruction (FMADD or FMSUB) and an operation using 2 instructions (FMUL and FADD).

#### Appendix 6.1.1 Rounding Mode

The rounding mode for an operation using both FMUL and FADD rounds both FMUL and FADD according to the setting of the FPSR RM field. However, the result of the FMADD or FMSUB instruction in Step 1 (multiply stage) is not rounded according to the setting of FPSR RM field, rather it is rounded toward zero.

#### Appendix 6.1.2 Exception occurring in Step 1

Two instructions are compared below as examples of Exception occurring in Step 1.

- FMUL + FADD:

FMUL    R3, R1, R2    ( $R3 = R1 * R2$ )  
FADD    R0, R3, R0    ( $R0 = R3 + R0$ )

- FMADD or FMSUB:

FMADD   R0, R1, R2    ( $R0 = R0 + R1 * R2$ )

Note: If the register supports different operations than those described above, the operations may differ in some ways to those shown below.

(1) Overflow occurs in Step 1

<When EO = 0, EX = 0: OVF and IXCT occur>

| Type of R0           | Condition                                        |      | FMUL + FADD Operation                             | FMADD Operation                   |
|----------------------|--------------------------------------------------|------|---------------------------------------------------|-----------------------------------|
| Normalized number, 0 | –                                                |      | R0 = OVF immediate value (Note 1) + R0            | R0 = OVF immediate value (Note 2) |
| Infinity             | when OVF immediate value                         | EV=0 | IVLD occurs<br>R0=H'7FFF FFFF                     | same as left                      |
|                      | is R0 and the opposite sign of the infinity sign | EV=1 | IVLD occurs, EIT occurs<br>R0 = maintained        | same as left                      |
|                      | factors other than above                         | –    | R0 = ∞<br>(same as original value)                | same as left                      |
| Denormalized number  | DN=0                                             |      | UIPL occurs, EIT occurs<br>R0 = maintained        | same as left                      |
|                      | DN=1                                             |      | R0 = OVF immediate value (Note 1)                 | same as left                      |
| QNaN                 | –                                                |      | R0 = maintained (QNaN)                            | same as left                      |
| SNaN                 | EV=0                                             |      | IVLD occurs<br>R0 = R0 converted to QNaN          | same as left                      |
|                      | EV=0                                             |      | IVLD occurs, EIT occurs<br>R0 = maintained (SNaN) | same as left                      |

**Note 1:** Refer to [Appendix Table 5.3.1 Operation Result due to OVF Exception] for immediate values if an overflow occurs due to Overflow Exclusion when the EIT processing is masked.

**Note 2:** In Step 1, the rounding mode is set to [Round toward 0]. However, when an overflow occurs, the immediate value is rounded according to the rounding mode. Refer to [Appendix Table 5.3.1 Operation Result due to OVF Exception] for these values. However, when the rounding mode is [round toward nearest], the OVF immediate value = infinity and the R0 value becomes the same as that of FMUL + FADD.

<When EO = 1: OVF occurs>

| Type of R0                     | Condition |  | FMUL + FADD Operation                                | FMADD Operation                               |
|--------------------------------|-----------|--|------------------------------------------------------|-----------------------------------------------|
| Normalized number, 0, Infinity | –         |  | EIT occurs when FMUL is completed<br>R0 = maintained | EIT occurs,<br>R0 = maintained                |
| Denormalized number            | DN=0      |  | Same as above                                        | UIPL occurs,<br>EIT occurs<br>R0 = maintained |
|                                | DN=1      |  | Same as above                                        | EIT occurs<br>R0 = maintained                 |
| QNaN                           | –         |  | Same as above                                        | Same as above                                 |
| SNaN                           | EV=0      |  | Same as above                                        | IVLD occurs,<br>EIT occurs<br>R0 = maintained |
|                                | EV=1      |  | Same as above                                        | Same as above                                 |

(2) When underflow occurs in Step 1

<When EU = 0, DN = 1: UDF occurs>

| Type of R0                     | Condition | FMUL + FADD Operation                               | FMADD Operation |
|--------------------------------|-----------|-----------------------------------------------------|-----------------|
| Normalized number, 0, Infinity | –         | $R0 = R0 + 0$                                       | Same as left    |
| Denormalized number            | –         | $R0 = 0$                                            | Same as left    |
| QNaN                           | –         | $R0 =$ maintained (QNaN)                            | Same as left    |
| SNaN                           | EV=0      | $R0 = R0$ converted to QNaN<br>IVLD occurs          | Same as left    |
|                                | EV=1      | $R0 =$ maintained (SNaN)<br>IVLD occurs, EIT occurs | Same as left    |

<When EU = 0, DN = 0: UDF and UIPL occur>

| Type of R0                     | Condition | FMUL + FADD Operation                                  | FMADD Operation                                 |
|--------------------------------|-----------|--------------------------------------------------------|-------------------------------------------------|
| Normalized number, 0, Infinity | –         | EIT occurs when FMUL is completed<br>$R0 =$ maintained | EIT occurs,<br>$R0 =$ maintained                |
| Denormalized number            | –         | Same as above                                          | Same as above                                   |
| QNaN                           | –         | Same as above                                          | Same as above                                   |
| SNaN                           | EV=0      | Same as above                                          | IVLD occurs,<br>EIT occurs<br>$R0 =$ maintained |
|                                | EV=1      | Same as above                                          | Same as above                                   |

<When EU = 1: UDF occurs>

| Type of R0                     | Condition | FMUL + FADD Operation                                  | FMADD Operation                                 |
|--------------------------------|-----------|--------------------------------------------------------|-------------------------------------------------|
| Normalized number, 0, Infinity | –         | EIT occurs when FMUL is completed<br>$R0 =$ maintained | EIT occurs,<br>$R0 =$ maintained                |
| Denormalized number            | DN=0      | Same as above                                          | UIPL occurs,<br>EIT occurs<br>$R0 =$ maintained |
|                                | DN=1      | Same as above                                          | EIT occurs<br>$R0 =$ maintained                 |
| QNaN                           | –         | Same as above                                          | Same as above                                   |
| SNaN                           | EV=0      | Same as above                                          | IVLD occurs,<br>EIT occurs<br>$R0 =$ maintained |
|                                | EV=1      | Same as above                                          | Same as above                                   |

(3) When Invalid Operation Exception occurs in Step 1

■ If at least one of [R1, R2] is an SNaN

<When EV = 0: IVLD occurs>

| Type of R0          | Condition | FMUL + FADD Operation               | FMADD Operation |
|---------------------|-----------|-------------------------------------|-----------------|
| Normalized          | –         | R0 = R3<br>(SNaN converted to QNaN) | Same as left    |
| Denormalized number | DN=0      | R0 = R3<br>(SNaN converted to QNaN) | Same as left    |
|                     | DN=1      | R0 = R3<br>(SNaN converted to QNaN) | Same as left    |
| QNaN                | –         | R0 = maintained (QNaN)              | Same as left    |
| SNaN                | –         | R0 = R0 converted to QNaN           | Same as left    |

<When EV = 1: IVLD occurs>

| Type of R0                     | Condition | FMUL + FADD Operation                                | FMADD Operation                               |
|--------------------------------|-----------|------------------------------------------------------|-----------------------------------------------|
| Normalized number, 0, Infinity | –         | EIT occurs when FMUL is completed<br>R0 = maintained | EIT occurs,<br>R0 = maintained                |
| Denormalized number            | DN=0      | Same as above                                        | UIPL occurs,<br>EIT occurs<br>R0 = maintained |
|                                | DN=1      | Same as above                                        | EIT occurs,<br>R0 = maintained                |
| QNaN                           | –         | Same as above                                        | Same as above                                 |
| SNaN                           | –         | Same as above                                        | Same as above                                 |

■ If “X ∞” occurs in [R1, R2]

<When EV = 0: IVLD occurs>

| Type of R0          | Condition | FMUL + FADD Operation     | FMADD Operation |
|---------------------|-----------|---------------------------|-----------------|
| Normalized          | –         | R0 = H'7FFF FFFF          | Same as left    |
| Denormalized number | DN=0      | R0 = H'7FFF FFFF          | Same as left    |
|                     | DN=1      | R0 = H'7FFF FFFF          | Same as left    |
| QNaN                | –         | R0 = maintained (QNaN)    | Same as left    |
| SNaN                | –         | R0 = R0 converted to QNaN | Same as left    |

<When EV = 1: IVLD occurs>

Same results as when “If at least one of [R1, R2] is an SNaN.”



(4) When Inexact Operation Exception occurs in Step 1

■ If an Inexact Operation occurs due to rounding:

<When EX = 0: IXCT occurs>

| Type of R0                     | Condition | FMUL + FADD Operation                             | FMADD Operation |
|--------------------------------|-----------|---------------------------------------------------|-----------------|
| Normalized number, 0, Infinity | –         | R0 = rounded value of $R1 * R2 + R0$              | Same as left    |
| Denormalized number            | DN=0      | UIPL occurs, EIT occurs<br>R0 = maintained        | Same as left    |
|                                | DN=1      | R0 = rounded value of $R1 * R2$                   | Same as left    |
| QNaN                           | –         | R0 = maintained (QNaN)                            | Same as left    |
| SNaN                           | EV=0      | IVLD occurs<br>R0 = R0 converted to QNaN          | Same as left    |
|                                | EV=1      | IVLD occurs, EIT occurs<br>R0 = maintained (SNaN) | Same as left    |

<When EX = 1: IXCT occurs>

| Type of R0                     | Condition | FMUL + FADD Operation                                | FMADD Operation                               |
|--------------------------------|-----------|------------------------------------------------------|-----------------------------------------------|
| Normalized number, 0, Infinity | –         | EIT occurs when FMUL is completed<br>R0 = maintained | EIT occurs,<br>R0 = maintained                |
| Denormalized number            | DN=0      | Same as above                                        | UIPL occurs,<br>EIT occurs<br>R0 = maintained |
|                                | DN=0      | Same as above                                        | EIT occurs<br>R0 = maintained                 |
| QNaN                           | –         | Same as above                                        | Same as above                                 |
| SNaN                           | EV=0      | Same as above                                        | IVLD occurs,<br>EIT occurs<br>R0 = maintained |
|                                | EV=1      | Same as above                                        | Same as above                                 |

■ When an Inexact Operation occurs due to an OVF at EO = 0:

<When EV = 0: IXCT occurs>

Refer to “(1) Overflow occurs in Step 1 <When EO = 0, EX = 0: OVF and IXCT occur>”.

<When EV = 1: IXCT occurs>

Same results as “■ If an Inexact Operation occurs due to rounding <when EX = 1: IXCT occurs>”.

#### Appendix 6.2 Rules concerning Generation of QNaN in M32R-FPU

The following are rules concerning generating a QNaN as an operation result. Instructions that generate NaNs as operation results are FADD, FSUB, FMUL, FDIV, FMADD, and FMSUB.

#### [Important Note]

This rule does not apply when the data that is sent to Rdest, the results of the FCMP or FCMPE comparison, comprise a NaN bit pattern.

#### <FADD, FSUB, FMUL, FDIV>

| Source Operand (Rsrc1, Rsrc2)       | Rdest                            |
|-------------------------------------|----------------------------------|
| SNaN and QNaN                       | SNaN converted to QNaN (Note 1)  |
| Both SNaN                           | Rsrc2 converted to QNaN (Note 1) |
| Both QNaN                           | Rsrc2                            |
| SNaN and actual number              | SNaN converted to QNaN (Note 1)  |
| QNaN and actual number              | QNaN                             |
| Neither operand is NaN; IVLD occurs | H'7FFF FFFF                      |

**Note 1:** SNaN b9 is set to "1" and the operand is converted to QNaN.

#### <FMADD, FMSUB>

| Source Operand |                                     | Rdest                            |
|----------------|-------------------------------------|----------------------------------|
| Rdest          | Rsrc1, Rsrc2                        |                                  |
| Actual number  | SNaN and QNaN                       | SNaN converted to QNaN (Note 1)  |
|                | Both SNaN                           | Rsrc2 converted to QNaN (Note 1) |
|                | Both QNaN                           | Rsrc2                            |
|                | SNaN and actual number              | SNaN converted to QNaN (Note 1)  |
|                | QNaN and actual number              | QNaN                             |
|                | Neither operand is NaN; IVLD occurs | H'7FFF FFFF                      |
| QNaN           | Don't care                          | Rdest (maintained)               |
| SNaN           | Don't care                          | Rdest converted to QNaN (Note 1) |

**Note 1:** SNaN b9 is set to "1" and the operand is converted to QNaN.

## Appendix 7 Precautions

### Appendix 7.1 Precautions to be taken when aligning data

When aligning or allocating the data area following the code area in a program, the alignment must be done from an address that has an adjusted word alignment.

If the data area is aligned or allocated without adjusting the word alignment, a 16-bit instruction may exist in the high-order halfword of the word, and data with MSB of “1” may be aligned to the following halfword. In this case, the M32R family upward-compatible CPU recognizes the 16-bit instruction and the data as a pair of parallel executable instructions and executes the instructions as such.

In consideration of the upward compatibility of software when programming, if the high-order halfword has a 16-bit instruction, make sure that the following data area is aligned or allocated from an address that has an adjusted word alignment.

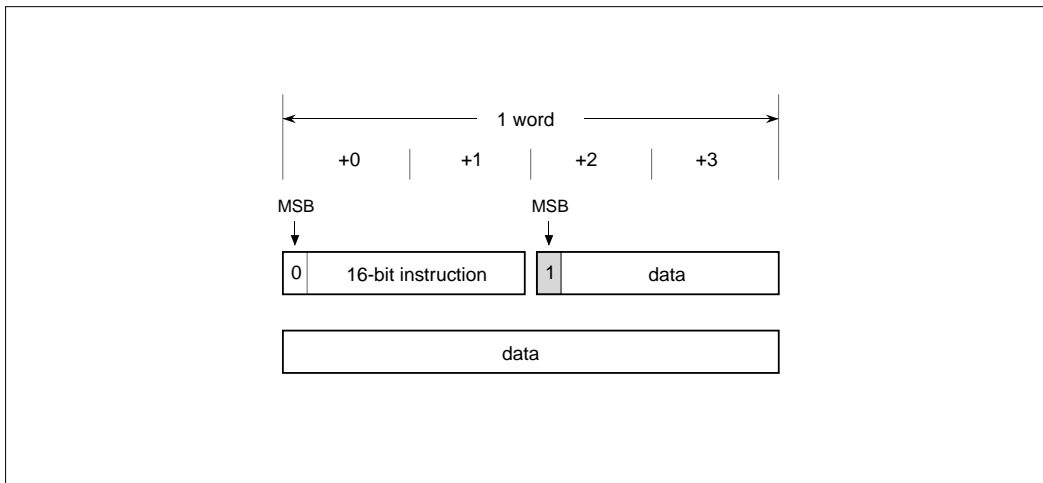

This page left blank intentionally.

# INDEX

---

# INDEX

---

## Symbol

#imm 1-15, 3-2  
@(disp,R) 1-15, 3-2  
@+R 1-15, 3-2  
@-R 1-15, 3-2  
@R 1-15, 3-2  
@R+ 1-15, 3-2

## A

Accumulator(ACC) 1-11  
Addressing Mode 1-15, 3-2  
Arithmetic operation instructions 2-4  
    ADD 3-6  
    ADD3 3-7  
    ADDI 3-8  
    ADDV 3-9  
    ADDV3 3-10  
    ADDX 3-11  
    NEG 3-86  
    SUB 3-113  
    SUBV 3-114  
    SUBX 3-115

## B

Backup PC(BPC) 1-5  
Bit operation instructions 2-11  
    BCLR 3-15  
    BSET 3-27  
    BTST 3-28  
    CLRPSW 3-29  
    SETPSW 3-99  
Branch instructions 2-6  
    BC 3-14  
    BEQ 3-16  
    BEQZ 3-17  
    BGEZ 3-18  
    BGTZ 3-19  
    BL 3-20  
    BLEZ 3-21  
    BLTZ 3-22  
    BNC 3-23  
    BNE 3-24

BNEZ 3-25  
BRA 3-26  
JL 3-59  
JMP 3-60  
NOP 3-87

## C

Compare instructions 2-4  
    CMP 3-30  
    CMPI 3-31  
    CMPU 3-32  
    CMPUI 3-33  
Condition Bit Register(CBR) 1-5  
Control registers 1-3  
CPU Programming Model 1-1  
CPU Register 1-2  
CR 1-3, 1-15  
CR0 1-3, 1-4  
CR1 1-3, 1-5  
CR2 1-3, 1-5  
CR3 1-3, 1-5  
CR6 1-3, 1-5  
CR7 1-3, 1-6

## D

Data format 1-13, 1-14  
Data format in a register 1-13  
Data format in memory 1-14  
Data type 1-12, 3-3  
DSP function instructions 2-8  
    MACHI 3-69  
    MACLO 3-70  
    MACWHI 3-71  
    MACWLO 3-72  
    MULHI 3-74  
    MULLO 3-75  
    MULWHI 3-76  
    MULWLO 3-77  
    MVFACHI 3-79  
    MVFACLO 3-80  
    MVFACMI 3-81  
    MVTACHI 3-83  
    MVTACLO 3-84  
    RAC 3-91  
    RACH 3-93

# INDEX

---

## E

EIT-related instructions 2-8  
RTE 3-97  
TRAP 3-116

## F

Floating-point instruction 2-11  
FADD 3-36  
FCMP 3-38  
FCMPE 3-40  
FDIV 3-42  
FMADD 3-44  
FMSUB 3-47  
FMUL 3-50  
FSUB 3-52  
FTOI 3-54  
FTOI 3-54  
ITOF 3-58  
UTOF 3-118

Floating-point Status Register 1-6

## G

General-purpose Registers 1-2

## H

Hexadecimal Instruction Code APPENDICES-2

## I

immediate 1-15, 3-2  
Instruction Execution Time APPENDICES-17  
Instruction format 2-12  
Instruction List APPENDICES-4  
Instruction set overview 2-2  
Interrupt Stack Pointer(SPI) 1-2, 1-3, 1-5

## L

Load/store instructions 2-2  
LD 3-61  
LDB 3-63  
LDH 3-64  
LDUB 3-66  
LDUH 3-67  
LOCK 3-68  
ST 3-109  
STB 3-111  
STH 3-112  
UNLOCK 3-117

Logic operation instructions 2-5  
AND 3-12  
AND3 3-13  
NOT 3-88  
OR 3-89  
OR3 3-90  
XOR 3-119  
XOR3 3-120

## M

Multiply/divide instructions 2-5  
DIV 3-34  
DIVU 3-35  
MUL 3-73  
REM 3-95  
REMU 3-96

## O

Operation expression 3-2, 3-3  
Operation instructions 2-4  
Operand List 3-2

## P

PC relative(pcdisp) 1-14, 3-2  
Processor Status Register(PSW) 1-3, 1-4  
Program Counter(PC) 1-11

# INDEX

---

## R

R 1-15, 3-2  
Register direct(R or CR) 1-15, 3-2  
Register indirect(@R) 1-15, 3-2  
Register indirect and register update 1-15, 3-2  
Register relative indirect(@disp, R) 1-15, 3-2

## S

Shift instructions 2-5  
    SLL 3-100  
    SLL3 3-101  
    SLLI 3-102  
    SRA 3-103  
    SRA3 3-104  
    SRAI 3-105  
    SRL 3-106  
    SRL3 3-107  
    SRLI 3-108  
Stack pointer 1-2, 1-5

## T

Transfer instructions 2-4  
    LD24 3-62  
    LDI 3-65  
    MV 3-78  
    MVFC 3-82  
    MVTC 3-85  
    SETH 3-98

## U

User Stack Pointer(SPU) 1-2, 1-3, 1-5



---

**RENESAS 32-BIT RISC SINGLE-CHIP MICROCOMPUTER  
SOFTWARE MANUAL  
M32R-FPU**

**Publication Data : Rev.1.00 Jan 08, 2003**

**Rev.1.01 Oct 31, 2003**

**Published by : Sales Strategic Planning Div.  
Renesas Technology Corp.**

# M32R-FPU Software Manual



Renesas Electronics Corporation

1753, Shimonumabe, Nakahara-ku, Kawasaki-shi, Kanagawa 211-8668 Japan

REJ09B0112-0101Z