

ISL85413EVAL1Z, ISL85412EVAL1Z

Evaluation Boards

AN1929
Rev 1.00
March 13, 2015

Description

The ISL85413EVAL1Z, ISL85412EVAL1Z kits are intended for use in point-of-load applications sourcing from 3.5V to 40V. The kits are used to demonstrate the performance of the ISL85413, ISL85412 Wide V_{IN} Low Quiescent Current High Efficiency Synchronous Buck Regulator with 300mA or 150mA output current.

The ISL85413, ISL85412 are offered in a 3mmx3mm 8 Ld DFN package with 1mm maximum height.

Specifications

The evaluation boards are designed to operate at the following operating conditions:

- Input voltage rating from 3.5V to 40V
- Fixed 3.3V output voltage
- Up to 300mA output current (ISL85413), up to 150mA output current (ISL85412)
- 700kHz switching frequency
- Operating junction temperature range: -40°C to +125°C

Key Features

- Small, compact design
- Switch selectable EN (enable/disabled)
- Switch selectable MODE (auto PFM/forced PWM)
- Connectors, test points and jumpers for easy probing

References

- Reference [ISL85413](#) and [ISL85412](#) datasheets for efficiency and typical performance curves

Ordering Information

PART NUMBER	DESCRIPTION
ISL85413EVAL1Z	Evaluation Board (300mA Output Current)
ISL85412EVAL1Z	Evaluation Board (150mA Output Current)



FIGURE 1. FRONT OF EVALUATION BOARD ISL85413EVAL1Z



FIGURE 2. BACK OF EVALUATION BOARD ISL85413EVAL1Z

Functional Description

The ISL85413EVAL1Z, ISL85412EVAL1Z provide simple platforms to demonstrate the features of the ISL85413, ISL85412 wide input synchronous buck regulator. The ISL85413EVAL1Z is for 300mA output current and ISL85412EVAL1Z is for 150mA output current. The evaluation boards have been functionally optimized for best performance of the ISL85413, ISL85412 ICs.

The ISL85413EVAL1Z board is shown in [Figures 1](#) and [2](#). The evaluation board contains an S1 switch that enables or disables the part, thus allowing low quiescent current state. The MODE function is controlled by a S2 switch that allows different mode operation. Default board configuration has $R_6 = 200k$ to V_{CC} , which defaults to PWM operation mode. If this pin is tied to GND, the IC will operate in PFM mode.

The schematic of the ISL85413EVAL1Z evaluation board is shown on [page 3](#). The PCB layout images for top and bottom layers are shown in [Figures 3](#) and [4](#). The Bill of Materials of the ISL85413EVAL1Z and ISL85412EVAL1Z is shown on [page 3](#).

Operating Range

The V_{IN} range of the boards is 3.5V to 40V. The V_{OUT} range is 0.6V to 12V. The operating junction temperature range is -40°C to $+125^{\circ}\text{C}$.

Recommended Equipment

The following materials are recommended to perform testing:

- 0V to 50V power supply with at least 2A source current capability
- Electronic loads capable of sinking current up to 1.5A
- Digital Multimeters (DMMs)
- 100MHz quad-trace oscilloscope
- Signal generator

TABLE 1. EXTERNAL COMPONENT SELECTION (REFER TO [Figure 1](#))

V_{OUT} (V)	C_4 (pF)	C_8 (μF)	L_1 (μH)	R_1 (k Ω)	R_2 (k Ω)
1.0	100	2x22	10	90.9	137
1.2	100	2x22	10	90.9	90.9
1.5	100	2x22	16	90.9	60.4
1.8	100	2x22	16	90.9	45.3
2.5	100	22	22	90.9	28.7
3.3	100	22	33	90.9	20.0
5.0	100	22	47	90.9	12.4
12	100	22	100	90.9	4.75

Quick Setup Guide

1. Ensure that the circuit is correctly connected to the supply and loads prior to applying any power.
2. Connect the bias supply to VIN, the plus terminal to VIN and the negative return to GND1.
3. Verify that the position is ON for S1.
4. Turn on the power supply.
5. Verify the output voltage is 3.3V for V_{OUT} .

Evaluating the Other Output Voltage

The ISL85413VAL1Z and ISL85412VAL1Z kit outputs are preset to 3.3V; however, output voltages can be adjusted from 0.6V to 12V. The output voltage programming resistor, R_2 , will depend on the desired output voltage of the regulator. The value for the feedback resistor is typically between 0Ω and $50k\Omega$ as shown in [Equation 1](#).

$$R_2 = R_1 \left(\frac{0.6}{V_{OUT} - 0.6} \right) \quad (\text{EQ. 1})$$

If the output voltage desired is 0.6V, then R_1 is shorted.

[Table 1](#) shows the component selection that should be used for the respective V_{OUT} .

ISL85413EVAL1Z Schematic

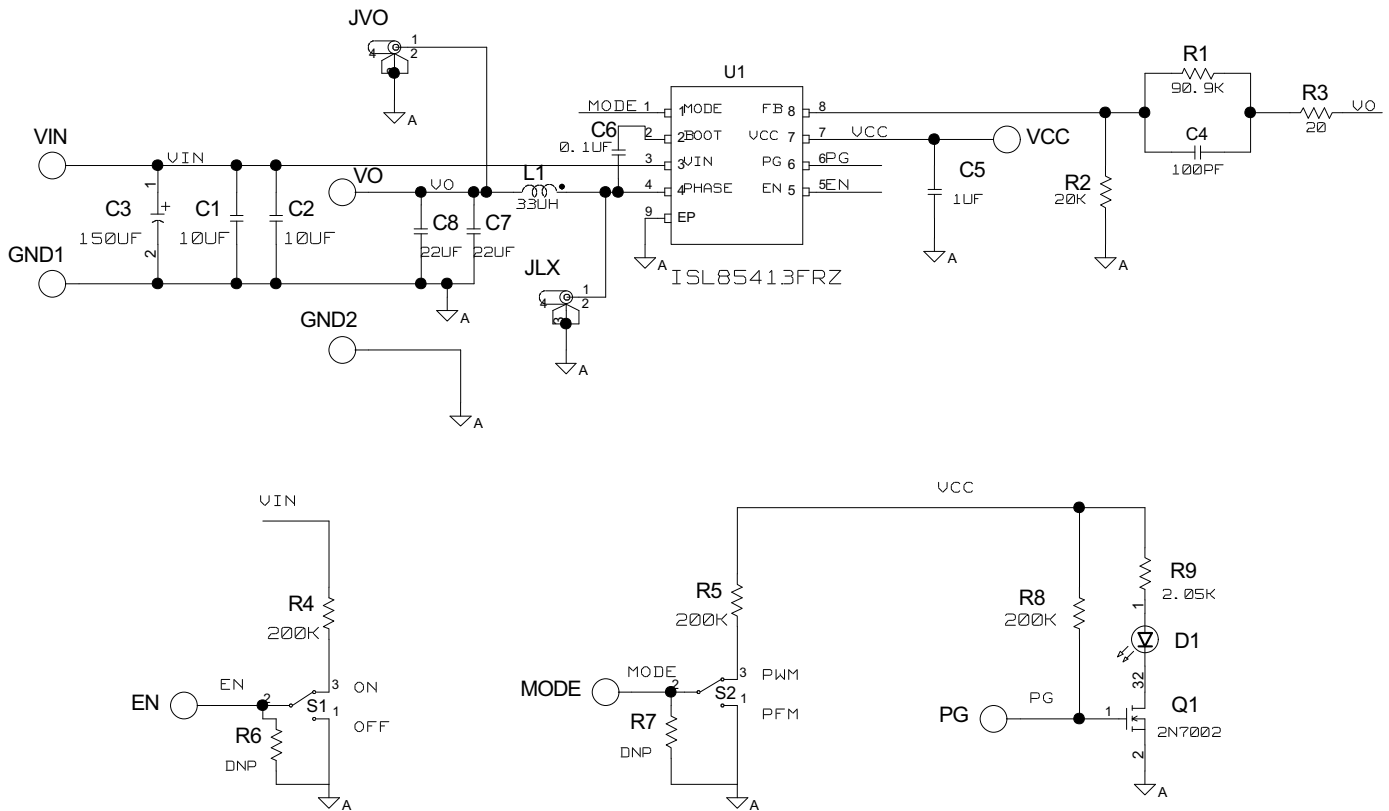

ISL85413EVAL1Z, ISL85412EVAL1Z Bill of Materials

MANUFACTURER PART	QTY	UNITS	REFERENCE DESIGNATOR	DESCRIPTION	MANUFACTURER
ISL85413EVAL1ZREVAPCB	1	ea	SEE LABEL-RENAME BOARD	PWB-PCB, ISL85413EVAL1Z, REVA, ROHS	TBD
C1608X7R1C105K	1	ea	C5	CAP, SMD, 0603, 1.0µF, 16V, 10%, X7R, ROHS	TDK
EEE-FK1H151P	1	ea	C3	CAP, SMD, 10.3mm, 150µF, 50V, 20%, ROHS, ALUM.ELEC.	PANASONIC
06035C104KAT2A	1	ea	C6	CAP, SMD, 0603, 0.1µF, 50V, 10%, X7R, ROHS	AVX
ECJ-1VC1H331J	1	ea	C4	CAP, SMD, 0603, 100pF, 50V, 5%, NP0, ROHS	PANASONIC
C3216X5R1H106K	2	ea	C1, C2	CAP, SMD, 1206, 10µF, 50V, 10%, X5R, ROHS	TDK
GRM31CR60J226KE19L	1	ea	C7	CAP, SMD, 1206, 22µF, 6.3V, 10%, X5R, ROHS	MURATA
	0	ea	C8	CAP, SMD, 1206, DNP-PLACE HOLDER, ROHS	
DR73-330-R	1	ea	L1	COIL-PWR INDUCTOR, SMD, 7.6mm, 33µH, 20%, 1.31A, ROHS	COOPER/COILTRONICS
131-4353-00	2	ea	JLX, JVO	CONN-SCOPE PROBE TEST PT, COMPACT, PCB MNT, ROHS	TEKTRONIX

ISL85413EVAL1Z, ISL85412EVAL1Z Bill of Materials (Continued)

MANUFACTURER PART	QTY	UNITS	REFERENCE DESIGNATOR	DESCRIPTION	MANUFACTURER
1514-2	4	ea	VO, VIN, GND1, GND2	CONN-TURRET, TERMINAL POST, TH, ROHS	KEYSTONE
5000	4	ea	EN, PG, VCC, SYNC	CONN-MINI TEST PT, VERTICAL, RED, ROHS	KEYSTONE
LTST-C190KGKT	1	ea	D1	LED, SMD, 0603, GREEN CLEAR, 2V, 20mA, 571nm, 35mcd, ROHS	LITEON/VISHAY
ISL85412FRZ for ISL85412EVAL1Z	1	ea	U1	IC-150mA BUCK REGULATOR, 12P, DFN, 3X3, ROHS	INTERSIL
ISL85413FRZ for ISL85413EVAL1Z	1	ea	U1	IC-300mA BUCK REGULATOR, 12P, DFN, 3X3, ROHS	INTERSIL
2N7002-7-F	1	ea	Q1	TRANSISTOR, N-CHANNEL, 3LD, SOT-23, 60V, 115mA, ROHS	DIODES, INC.
	0	ea	R6, R7	RESISTOR, SMD, 0603, 0.1%, MF, DNP-PLACE HOLDER	
ERJ-3EKF20R0V	1	ea	R3	RES, SMD, 0603, 20Ω, 1/10W, 1%, TF, ROHS	PANASONIC
CR0603-10W-2002FT	1	ea	R2	RES, SMD, 0603, 20k, 1/10W, 1%, TF, ROHS	VENKEL
CR0603-10W-2003FT	3	ea	R4, R5, R8	RES, SMD, 0603, 200k, 1/10W, 1%, TF, ROHS	VENKEL
CR0603-10W-2051FT	1	ea	R9	RES, SMD, 0603, 2.05k, 1/10W, 1%, TF, ROHS	VENKEL
ERJ-3EKF9102V	1	ea	R1	RES, SMD, 0603, 91k, 1/10W, 1%, TF, ROHS	PANASONIC
GT11MSCBE	2	ea	S1, S2	SWITCH-TOGGLE, SMD, 6PIN, SPDT, 2POS, ON-ON, ROHS	ITT INDUSTRIES/ C&K DIVISION

ISL85413EVAL1Z Board Layout

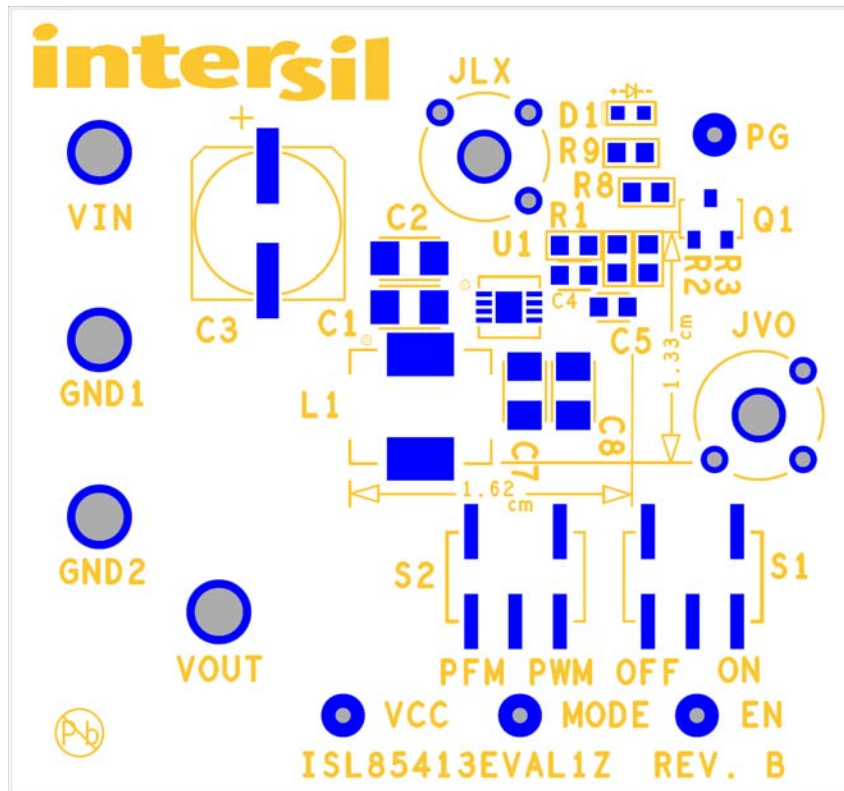

FIGURE 3. SILK SCREEN TOP

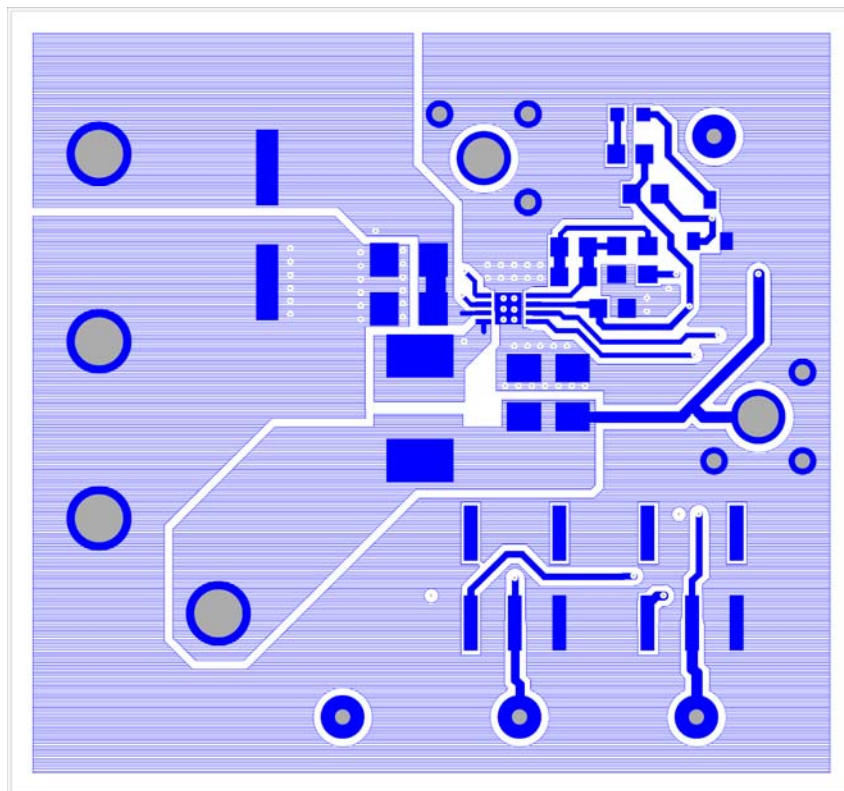

FIGURE 4. TOP LAYER COMPONENT SIDE

ISL85413EVAL1Z Board Layout (Continued)

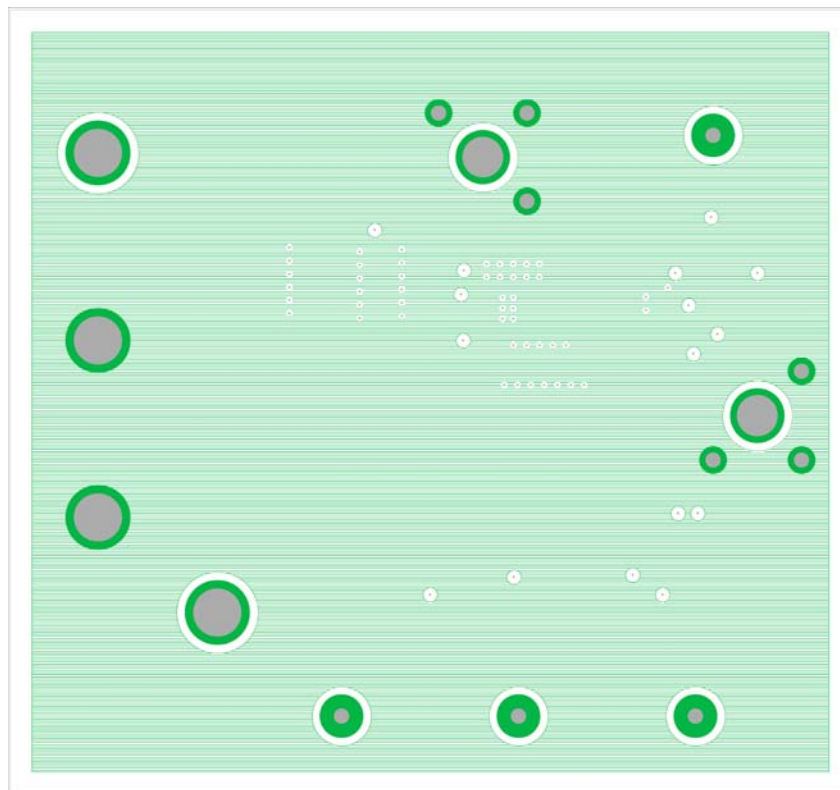

FIGURE 5. LAYER 2

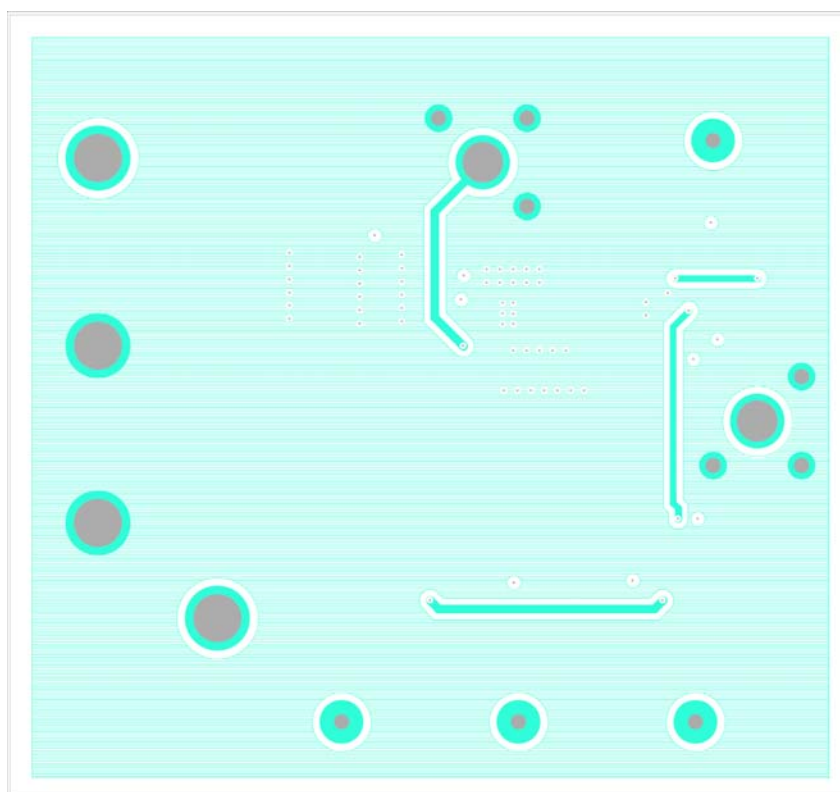

FIGURE 6. LAYER 3

ISL85413EVAL1Z Board Layout (Continued)

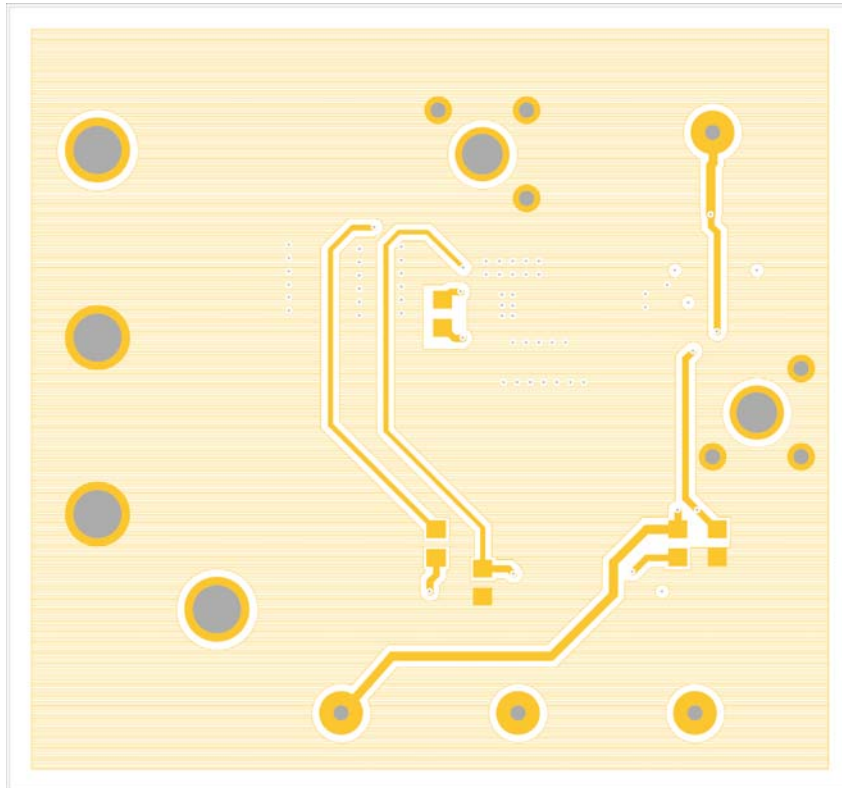

FIGURE 7. LAYER 4

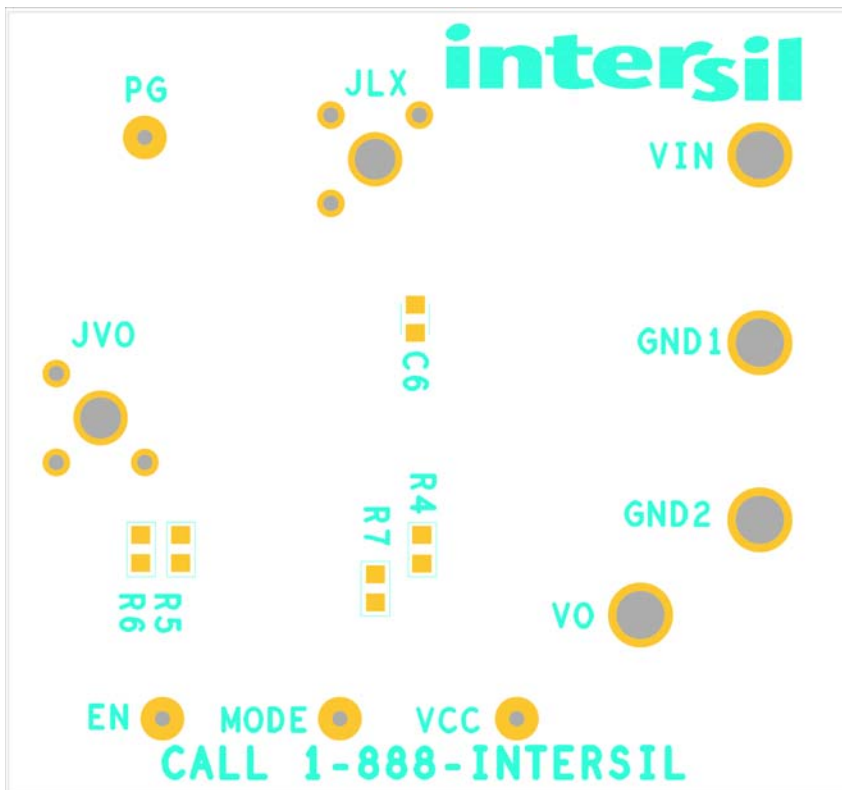

FIGURE 8. SILK SCREEN BOTTOM

Notice

1. Descriptions of circuits, software and other related information in this document are provided only to illustrate the operation of semiconductor products and application examples. You are fully responsible for the incorporation or any other use of the circuits, software, and information in the design of your product or system. Renesas Electronics disclaims any and all liability for any losses and damages incurred by you or third parties arising from the use of these circuits, software, or information.
2. Renesas Electronics hereby expressly disclaims any warranties against and liability for infringement or any other claims involving patents, copyrights, or other intellectual property rights of third parties, by or arising from the use of Renesas Electronics products or technical information described in this document, including but not limited to, the product data, drawings, charts, programs, algorithms, and application examples.
3. No license, express, implied or otherwise, is granted hereby under any patents, copyrights or other intellectual property rights of Renesas Electronics or others.
4. You shall not alter, modify, copy, or reverse engineer any Renesas Electronics product, whether in whole or in part. Renesas Electronics disclaims any and all liability for any losses or damages incurred by you or third parties arising from such alteration, modification, copying or reverse engineering.
5. Renesas Electronics products are classified according to the following two quality grades: "Standard" and "High Quality". The intended applications for each Renesas Electronics product depends on the product's quality grade, as indicated below.
"Standard": Computers; office equipment; communications equipment; test and measurement equipment; audio and visual equipment; home electronic appliances; machine tools; personal electronic equipment; industrial robots; etc.
"High Quality": Transportation equipment (automobiles, trains, ships, etc.); traffic control (traffic lights); large-scale communication equipment; key financial terminal systems; safety control equipment; etc.
Unless expressly designated as a high reliability product or a product for harsh environments in a Renesas Electronics data sheet or other Renesas Electronics document, Renesas Electronics products are not intended or authorized for use in products or systems that may pose a direct threat to human life or bodily injury (artificial life support devices or systems; surgical implantations; etc.), or may cause serious property damage (space system; undersea repeaters; nuclear power control systems; aircraft control systems; key plant systems; military equipment; etc.). Renesas Electronics disclaims any and all liability for any damages or losses incurred by you or any third parties arising from the use of any Renesas Electronics product that is inconsistent with any Renesas Electronics data sheet, user's manual or other Renesas Electronics document.
6. When using Renesas Electronics products, refer to the latest product information (data sheets, user's manuals, application notes, "General Notes for Handling and Using Semiconductor Devices" in the reliability handbook, etc.), and ensure that usage conditions are within the ranges specified by Renesas Electronics with respect to maximum ratings, operating power supply voltage range, heat dissipation characteristics, installation, etc. Renesas Electronics disclaims any and all liability for any malfunctions, failure or accident arising out of the use of Renesas Electronics products outside of such specified ranges.
7. Although Renesas Electronics endeavors to improve the quality and reliability of Renesas Electronics products, semiconductor products have specific characteristics, such as the occurrence of failure at a certain rate and malfunctions under certain use conditions. Unless designated as a high reliability product or a product for harsh environments in a Renesas Electronics data sheet or other Renesas Electronics document, Renesas Electronics products are not subject to radiation resistance design. You are responsible for implementing safety measures to guard against the possibility of bodily injury, injury or damage caused by fire, and/or danger to the public in the event of a failure or malfunction of Renesas Electronics products, such as safety design for hardware and software, including but not limited to redundancy, fire control and malfunction prevention, appropriate treatment for aging degradation or any other appropriate measures. Because the evaluation of microcomputer software alone is very difficult and impractical, you are responsible for evaluating the safety of the final products or systems manufactured by you.
8. Please contact a Renesas Electronics sales office for details as to environmental matters such as the environmental compatibility of each Renesas Electronics product. You are responsible for carefully and sufficiently investigating applicable laws and regulations that regulate the inclusion or use of controlled substances, including without limitation, the EU RoHS Directive, and using Renesas Electronics products in compliance with all these applicable laws and regulations. Renesas Electronics disclaims any and all liability for damages or losses occurring as a result of your noncompliance with applicable laws and regulations.
9. Renesas Electronics products and technologies shall not be used for or incorporated into any products or systems whose manufacture, use, or sale is prohibited under any applicable domestic or foreign laws or regulations. You shall comply with any applicable export control laws and regulations promulgated and administered by the governments of any countries asserting jurisdiction over the parties or transactions.
10. It is the responsibility of the buyer or distributor of Renesas Electronics products, or any other party who distributes, disposes of, or otherwise sells or transfers the product to a third party, to notify such third party in advance of the contents and conditions set forth in this document.
11. This document shall not be reprinted, reproduced or duplicated in any form, in whole or in part, without prior written consent of Renesas Electronics.
12. Please contact a Renesas Electronics sales office if you have any questions regarding the information contained in this document or Renesas Electronics products.
(Note 1) "Renesas Electronics" as used in this document means Renesas Electronics Corporation and also includes its directly or indirectly controlled subsidiaries.
(Note 2) "Renesas Electronics product(s)" means any product developed or manufactured by or for Renesas Electronics.

(Rev.4.0-1 November 2017)



SALES OFFICES

Renesas Electronics Corporation

<http://www.renesas.com>

Refer to "<http://www.renesas.com/>" for the latest and detailed information.

Renesas Electronics America Inc.
1001 Murphy Ranch Road, Milpitas, CA 95035, U.S.A.
Tel: +1-408-432-8888, Fax: +1-408-434-5351

Renesas Electronics Canada Limited
9251 Yonge Street, Suite 8309 Richmond Hill, Ontario Canada L4C 9T3
Tel: +1-905-237-2004

Renesas Electronics Europe Limited
Dukes Meadow, Millboard Road, Bourne End, Buckinghamshire, SL8 5FH, U.K
Tel: +44-1628-651-700, Fax: +44-1628-651-804

Renesas Electronics Europe GmbH
Arcadiastrasse 10, 40472 Düsseldorf, Germany
Tel: +49-211-6503-0, Fax: +49-211-6503-1327

Renesas Electronics (China) Co., Ltd.
Room 1709 Quantum Plaza, No.27 ZhichunLu, Haidian District, Beijing, 100191 P. R. China
Tel: +86-10-8235-1155, Fax: +86-10-8235-7679

Renesas Electronics (Shanghai) Co., Ltd.
Unit 301, Tower A, Central Towers, 555 Langao Road, Putuo District, Shanghai, 200333 P. R. China
Tel: +86-21-2226-0888, Fax: +86-21-2226-0999

Renesas Electronics Hong Kong Limited
Unit 1601-1611, 16/F., Tower 2, Grand Century Place, 193 Prince Edward Road West, Mongkok, Kowloon, Hong Kong
Tel: +852-2265-6688, Fax: +852-2886-9022

Renesas Electronics Taiwan Co., Ltd.
13F, No. 363, Fu Shing North Road, Taipei 10543, Taiwan
Tel: +886-2-8175-9600, Fax: +886-2-8175-9670

Renesas Electronics Singapore Pte. Ltd.
80 Bendemeer Road, Unit #06-02 Hyflux Innovation Centre, Singapore 339949
Tel: +65-6213-0200, Fax: +65-6213-0300

Renesas Electronics Malaysia Sdn.Bhd.
Unit 1207, Block B, Menara Amcorp, Amcorp Trade Centre, No. 18, Jln Persiaran Barat, 46050 Petaling Jaya, Selangor Darul Ehsan, Malaysia
Tel: +60-3-7955-9390, Fax: +60-3-7955-9510

Renesas Electronics India Pvt. Ltd.
No.777C, 100 Feet Road, HAL 2nd Stage, Indiranagar, Bangalore 560 038, India
Tel: +91-80-67208700, Fax: +91-80-67208777

Renesas Electronics Korea Co., Ltd.
17F, KAMCO Yangjae Tower, 262, Gangnam-daero, Gangnam-gu, Seoul, 06265 Korea
Tel: +82-2-558-3737, Fax: +82-2-558-5338