

ISL78420EVAL1Z

Evaluation Board User Guide

UG006
Rev 0.00
October 15, 2014

Description

The ISL78420EVAL1Z evaluation board is designed for a user to evaluate the ISL78420 100V 2A half-bridge driver with tri-level PWM input for driving the gates of two NMOS FETs in a half-bridge configuration. These NFET MOSFETs are included on the evaluation board to evaluate a half-bridge driven load such as a DC motor or a synchronous switching regulator.

The ISL78420 is offered in a 14 Ld HTSSOP package enhanced with a thermal EPAD. It operates from a supply voltage of 8V to 14V DC with the capability of driving a high-side NMOS FET in a 100V half-bridge configuration. A unique tri-level PWM input allows control of both the high and low-side gate driver with a single input. When the PWM pin is left in a floating high impedance state both gate drivers are turned off, which is beneficial for multiphase DC/DC switching that requires phase shedding.

Specifications

This board is optimized for the following operating conditions:

- VDD supply: 8V to 14V
- PWM switching frequency: 10kHz to 1MHz
- Preset half-bridge dead time: 35ns
- Peak gate drive current: 2A source and sink
- Half-bridge voltage: Up to 100V

Key Features

- 2A source and sink NMOS gate drivers
- Internal level shifter and bootstrap diode for gate driver on high-side FET
- Up to 100V high-side gate drive reference
- 8V to 14V bias supply operation
- Single PWM input for high-side and low-side gate driver with tri-level for turning off both drivers
- Single resistor adjustable dead time from 35ns to 220ns

Reference Documents

- [ISL78420](#) datasheet
- [ISL78225](#) datasheet
- [AN1727](#), "ISL78225EVAL1Z: 4-Phase Interleaved Synchronous Boost Converter"

Ordering Information

PART NUMBER	DESCRIPTION
ISL78420EVAL1Z	Evaluation Board, 100V 2A Half-Bridge Driver with Tri-Level Input

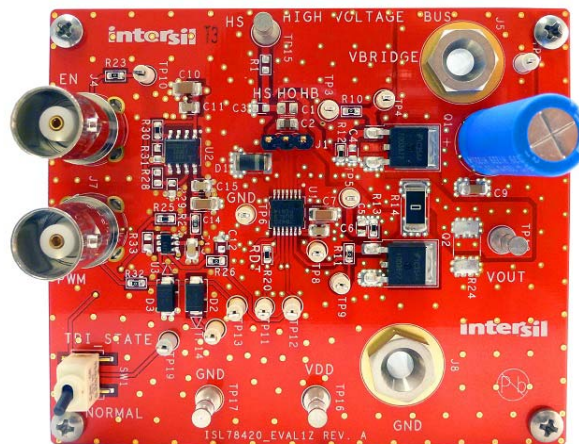

FIGURE 1. ISL78420EVAL1Z EVALUATION BOARD

Recommended Equipment

The following equipment is recommended to operate this board:

- 8V to 14V power supply with at least 2A source current capability
- 0V to 100V power supply for biasing the half bridge
- Digital multimeters (DMMs)
- Up to 1MHz square wave generator
- Load such as a DC motor or buck regulator output stage (optional)

Quick Setup Guide

1. The dead time of the HO and LO signal is set to 35ns with an 80k Ω resistor from the RDT pin to GND. To change the dead time, replace the resistor at R20 with the value corresponding to the desired dead time. See [Figure 9](#).
2. Apply 10V to 14V to VDD and GND.
3. Connect EN BNC to a function generator to control the enable of the ISL78420 or connect to VDD to always enable.
4. If evaluating the bridge circuit, connect a bridge supply <100V to the banana jack connectors J5 and J8. Connect load at R24.
5. Connect a 0V to 5V <1MHz PWM signal to J7.
6. Verify HO and LO outputs are switching. LO switches between GND and VDD phase inverted from PWM. HO switches between GND and $V_{HB} + V_{BRIDGE}$ in phase with PWM.

Bootstrap Capacitor

The ISL78420 requires an external bootstrap capacitor between the HB and HS pins to provide the high-side supply biasing to generate the level shifted gate voltage on the HO pin and more importantly, deliver the gate drive current to switch the high-side NMOS FET.

The ISL78420EVAL1Z is populated with a 0.47 μ F capacitor at C2 for the bootstrap function. This value will provide optimal bias for switching frequencies ≥ 10 kHz and is capable of delivering the dynamic current for 100nC total gate charge while maintaining <5% ripple voltage. See page 10 of the [ISL78420](#) datasheet for optimizing the bootstrap capacitance at different operating conditions.

Dead Time Control

The ISL78420 features a dead time control circuit for programming the delay between the falling edge of HO to rising edge of LO and between the falling edge of LO to rising edge of HO. A single resistor from the RDT pin to GND adjusts the dead time from 35ns (80k Ω) to 220ns (8k Ω). The ISL78420EVAL1Z contains a 80k Ω resistor at R20 which sets the dead time to 35ns. Refer to [Figure 9](#) for selecting a resistor value for the desired dead time.

Tri-Level Input

The ISL78420 has a single input pin (PWM) for controlling the HO/LO high-side and low-side gate drivers. See [Table 1](#) below for logic table of PWM to HO and LO. When the PWM pin is left floating or driven to a valid tri-level voltage, both HO and LO outputs are driven low.

Because some function generators do not have a high impedance disable function (when disabled, the generator output pulls to GND), the ISL78420EVAL1Z has a switch SW1 on board to isolate the function generator signal to the PWM input. Otherwise, the PWM signal is taken to ground which keeps the LO output at VDD voltage and the HO output at HS voltage.

TABLE 1. TRI-LEVEL PWM LOGIC INPUT

PWM	GATE DRIVE	HO/LO OUTPUT VOLTAGE
HIGH	HO	Driven to HB+HS
	LO	Driven to VSS
MID	HO	Driven to HS
	LO	Driven to VSS
LOW	HO	Driven to HS
	LO	Driven to VDD

Half Bridge Configured MOSFETs

The ISL78420EVAL1Z includes a bridge configured high side (Q1) and low side (Q2) FET. These devices are automotive grade 100V NMOS FETs. The source of the high-side FET and drain of the low-side FET are connected together to the HS node of the ISL78420. The HO pin drives the gate of Q1 and the LO pin drives the gate of Q2. The 0.47 μ F boot capacitor is designed to provide the necessary gate drive to switch Q1 to frequencies down to 10kHz with minimal ripple on the bootstrap bias.

Other Circuits

The ISL78420EVAL1Z also contains an automotive grade LDO (ISL78307) and SPDT switch (ISL76123) which is used to switch between the PWM signal external to the ISL78420 or have the signal path open, allowing the ISL78420 PWM pin to float to a tri-level state. The ISL78307 LDO accepts the 10V to 14V VDD input voltage and outputs a constant 5V bias for the ISL76123 analog switch that connects or disconnects the signal at J7 BNC from the PWM pin of ISL78420. The switch SW1 toggles the logic state of the ISL76123.

ISL78420EVAL1Z Schematic

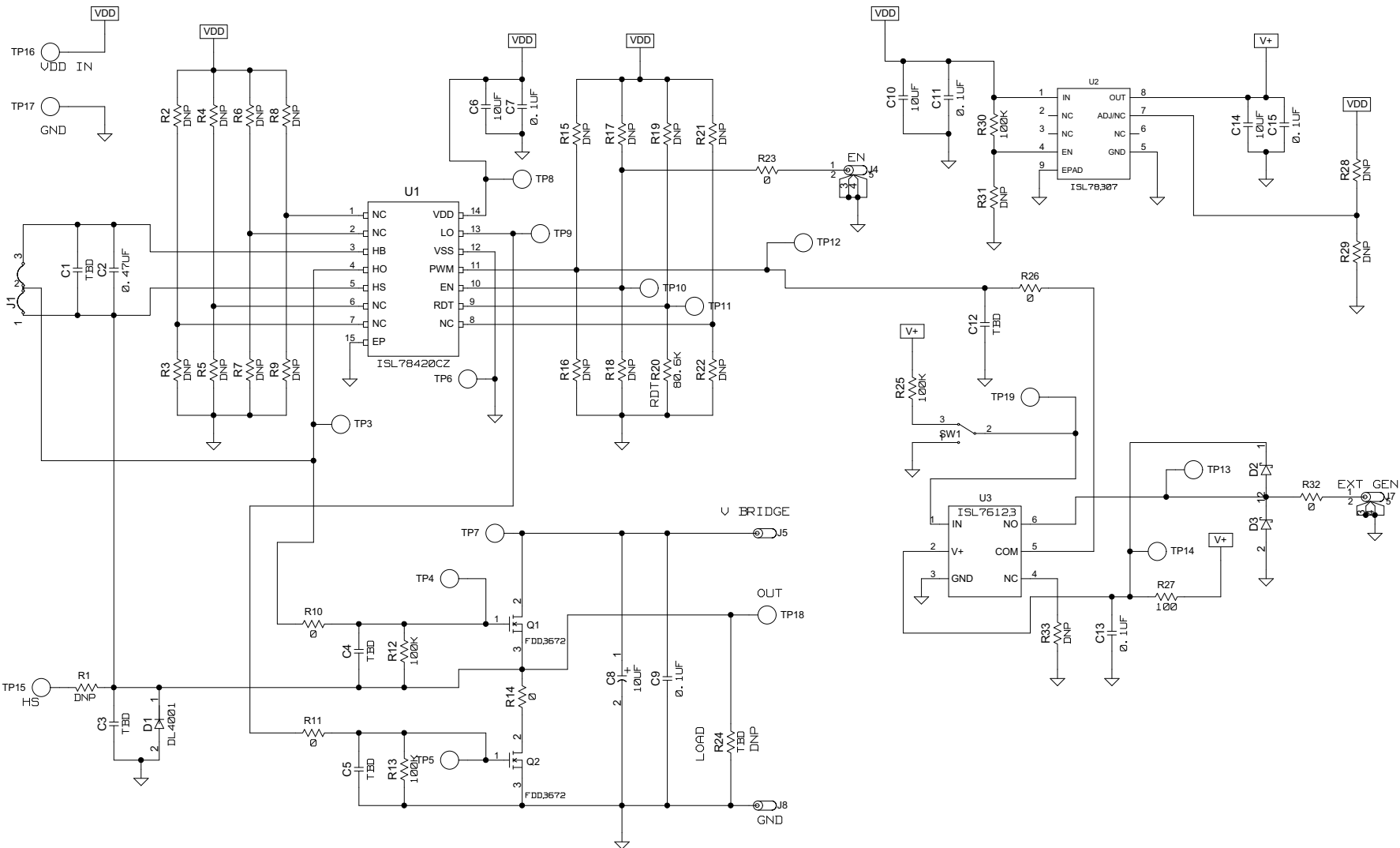

BILL OF MATERIALS

PART NUMBER	REFERENCE DESIGNATOR	DESCRIPTION	MANUFACTURER
ISL78420AVEZ	U1	100V; 2A BRIDGE DRIVER	INTERSIL
ISL76123AHZ	U3	300mA SPDT SWITCH; SOT26	INTERSIL
ISL78307FBEBZ	U2	40V; 50mA LDO; SOIC	INTERSIL
10MQ060N	D2, D3	2.1A 60V SCHOTTKY	IR
DL4001	D1	50V; 1A DIODE	MCC
FDD3672	Q1, Q2	NFET 100V, 44A, 28mΩ, TO-252	FAIRCHILD
GT11MSCBETR	SW1	SPDT SWITCH	C&K
UBT2D100MPD1TD	C8	10μF CAP; 200V; 20%; RADIAL	NICHICON
	C6, C10, C14	10μF CAP; 50V; 10%; 1206	GENERIC
	C7, C11, C13, C15	0.1μF CAP; 50V; 5%; 0805	GENERIC
	C2	0.47μF CAP; 50V; 10%; 0805	GENERIC
	C9	0.1μF CAP; 200V; 10%; 1206	GENERIC
	R10, R11, R23, R26, R32	0Ω; 1/16W; 1%; 0603	GENERIC
	R27	100Ω; 1/16W; 1%; 0603	GENERIC
	R12, R13, R25, R30	100kΩ; 1/16W; 1%; 0603	GENERIC
	R20	80.6kΩ; 1/16W; 1%; 0603	GENERIC
	R14	0Ω; 1W; 1%; 2512	GENERIC
	TP3-TP19	TEST POINT	
	J5, J8	BANANA JACK	
	J4, J7	BNC CONNECTOR	
PCB SPECIFICATION		2oz Cu; 1.57mm Thickness FR-4	

ISL78420EVAL1Z Board Layout

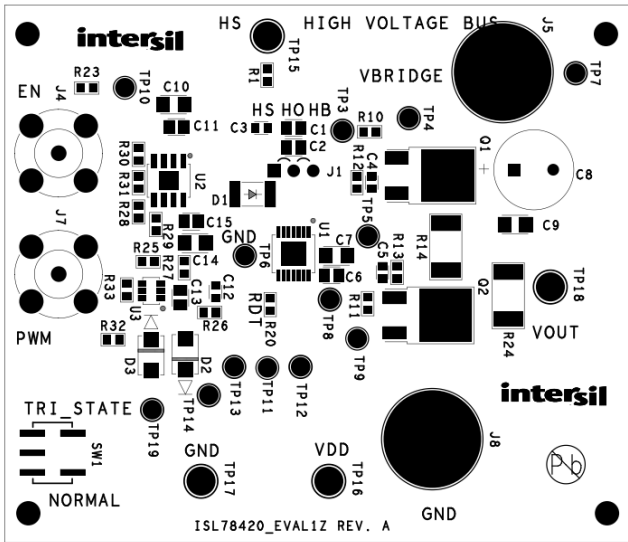

FIGURE 2. SILK SCREEN TOP

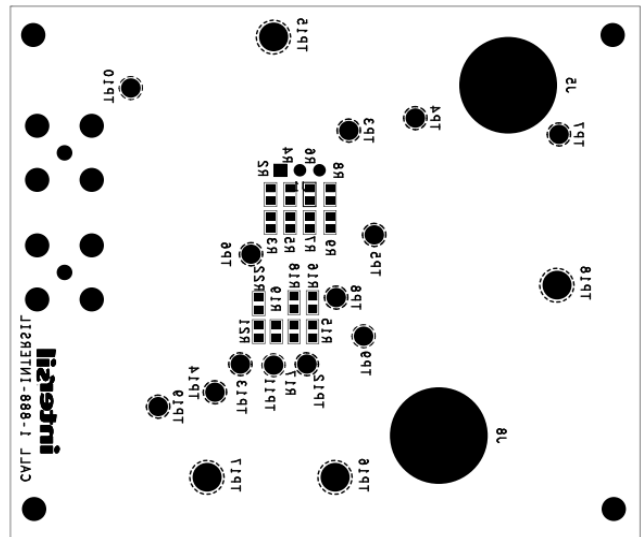

FIGURE 3. SILK SCREEN BOTTOM

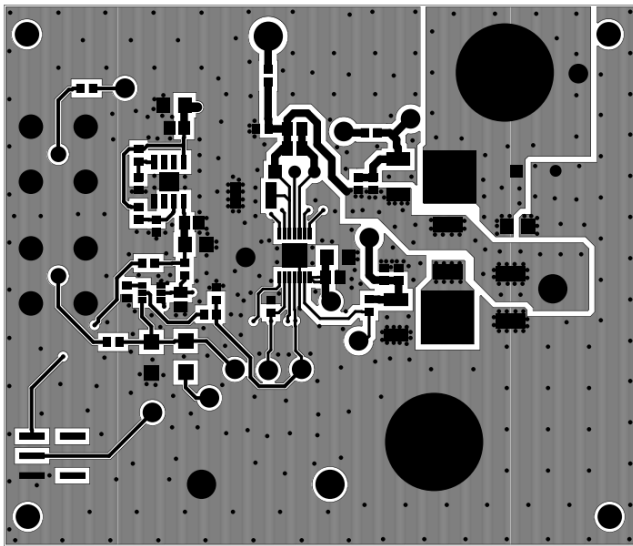

FIGURE 4. TOP LAYER PCB

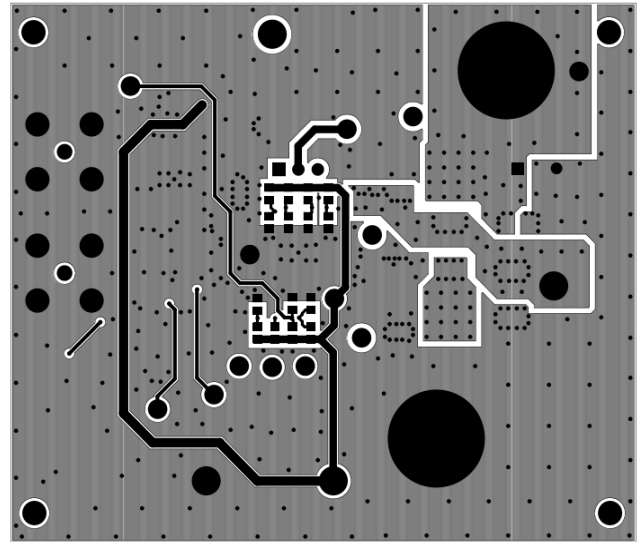

FIGURE 5. BOTTOM LAYER PCB

Typical Performance Curves

Unless otherwise specified, operating conditions at: $T = 25^{\circ}\text{C}$; $V_{\text{DD}} = \text{EN} = 12\text{V}$;

$V_{\text{SS}} = \text{HS} = 0\text{V}$; $\text{RDT} = 10\text{k}\Omega$; $\text{C}_{\text{BOOT}} = 0.47\mu\text{F}$; $100\text{k}\Omega$ load on LO to V_{SS} and HO to HS.

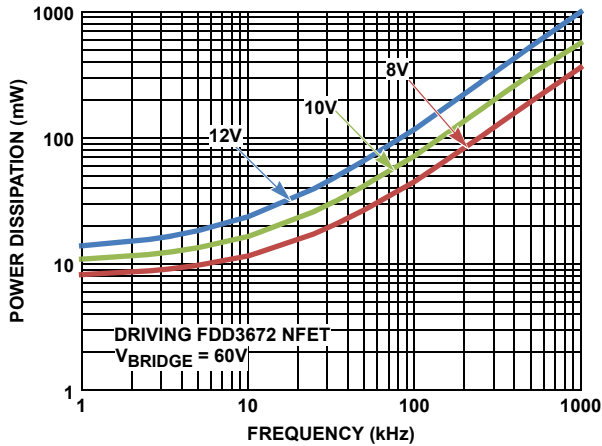

FIGURE 6. POWER DISSIPATION vs FREQUENCY vs VDD with NFET LOAD

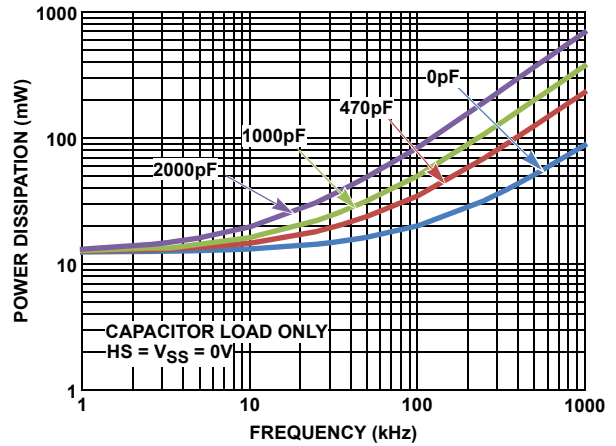

FIGURE 7. POWER DISSIPATION vs FREQUENCY vs CAPACITIVE LOAD

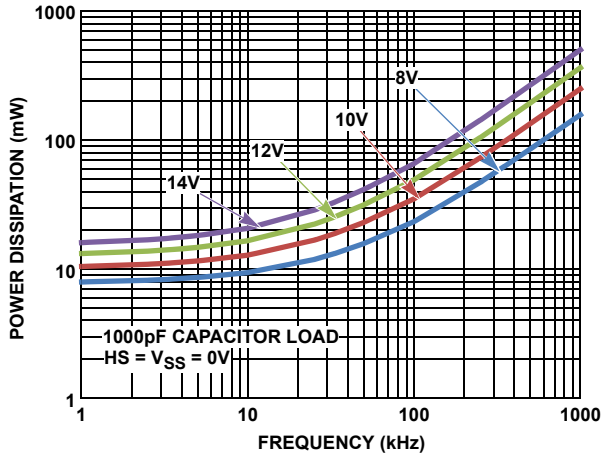

FIGURE 8. POWER DISSIPATION vs FREQUENCY vs VDD

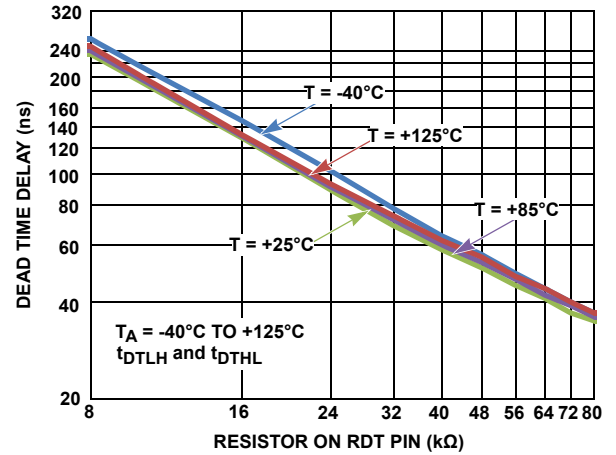

FIGURE 9. DEAD TIME DELAY vs RDT RESISTOR

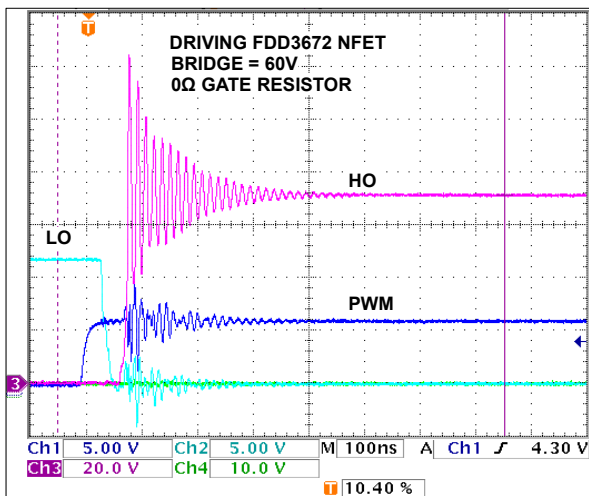

FIGURE 10. PWM, LO AND HO PULSE WAVEFORM

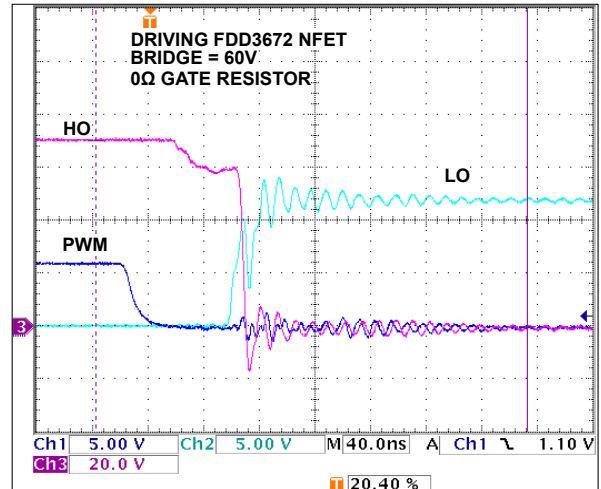

FIGURE 11. PWM, LO AND HO PULSE WAVEFORM

Typical Performance Curves

Unless otherwise specified, operating conditions at: $T = 25^{\circ}\text{C}$; $V_{\text{DD}} = \text{EN} = 12\text{V}$;

$V_{\text{SS}} = \text{HS} = 0\text{V}$; $\text{RDT} = 10\text{k}\Omega$; $\text{C}_{\text{BOOT}} = 0.47\mu\text{F}$; $100\text{k}\Omega$ load on LO to VSS and HO to HS. (Continued)

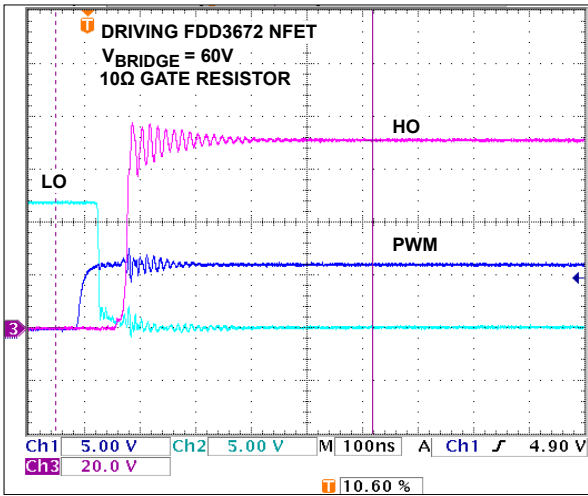

FIGURE 12. PWM, LO AND HO PULSE WAVEFORM

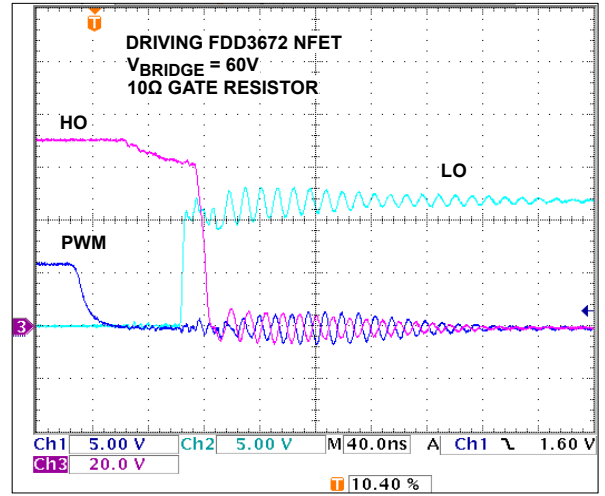

FIGURE 13. PWM, LO AND HO PULSE WAVEFORM

Notice

1. Descriptions of circuits, software and other related information in this document are provided only to illustrate the operation of semiconductor products and application examples. You are fully responsible for the incorporation or any other use of the circuits, software, and information in the design of your product or system. Renesas Electronics disclaims any and all liability for any losses and damages incurred by you or third parties arising from the use of these circuits, software, or information.
2. Renesas Electronics hereby expressly disclaims any warranties against and liability for infringement or any other claims involving patents, copyrights, or other intellectual property rights of third parties, by or arising from the use of Renesas Electronics products or technical information described in this document, including but not limited to, the product data, drawings, charts, programs, algorithms, and application examples.
3. No license, express, implied or otherwise, is granted hereby under any patents, copyrights or other intellectual property rights of Renesas Electronics or others.
4. You shall not alter, modify, copy, or reverse engineer any Renesas Electronics product, whether in whole or in part. Renesas Electronics disclaims any and all liability for any losses or damages incurred by you or third parties arising from such alteration, modification, copying or reverse engineering.
5. Renesas Electronics products are classified according to the following two quality grades: "Standard" and "High Quality". The intended applications for each Renesas Electronics product depends on the product's quality grade, as indicated below.
"Standard": Computers; office equipment; communications equipment; test and measurement equipment; audio and visual equipment; home electronic appliances; machine tools; personal electronic equipment; industrial robots; etc.
"High Quality": Transportation equipment (automobiles, trains, ships, etc.); traffic control (traffic lights); large-scale communication equipment; key financial terminal systems; safety control equipment; etc.
Unless expressly designated as a high reliability product or a product for harsh environments in a Renesas Electronics data sheet or other Renesas Electronics document, Renesas Electronics products are not intended or authorized for use in products or systems that may pose a direct threat to human life or bodily injury (artificial life support devices or systems; surgical implantations; etc.), or may cause serious property damage (space system; undersea repeaters; nuclear power control systems; aircraft control systems; key plant systems; military equipment; etc.). Renesas Electronics disclaims any and all liability for any damages or losses incurred by you or any third parties arising from the use of any Renesas Electronics product that is inconsistent with any Renesas Electronics data sheet, user's manual or other Renesas Electronics document.
6. When using Renesas Electronics products, refer to the latest product information (data sheets, user's manuals, application notes, "General Notes for Handling and Using Semiconductor Devices" in the reliability handbook, etc.), and ensure that usage conditions are within the ranges specified by Renesas Electronics with respect to maximum ratings, operating power supply voltage range, heat dissipation characteristics, installation, etc. Renesas Electronics disclaims any and all liability for any malfunctions, failure or accident arising out of the use of Renesas Electronics products outside of such specified ranges.
7. Although Renesas Electronics endeavors to improve the quality and reliability of Renesas Electronics products, semiconductor products have specific characteristics, such as the occurrence of failure at a certain rate and malfunctions under certain use conditions. Unless designated as a high reliability product or a product for harsh environments in a Renesas Electronics data sheet or other Renesas Electronics document, Renesas Electronics products are not subject to radiation resistance design. You are responsible for implementing safety measures to guard against the possibility of bodily injury, injury or damage caused by fire, and/or danger to the public in the event of a failure or malfunction of Renesas Electronics products, such as safety design for hardware and software, including but not limited to redundancy, fire control and malfunction prevention, appropriate treatment for aging degradation or any other appropriate measures. Because the evaluation of microcomputer software alone is very difficult and impractical, you are responsible for evaluating the safety of the final products or systems manufactured by you.
8. Please contact a Renesas Electronics sales office for details as to environmental matters such as the environmental compatibility of each Renesas Electronics product. You are responsible for carefully and sufficiently investigating applicable laws and regulations that regulate the inclusion or use of controlled substances, including without limitation, the EU RoHS Directive, and using Renesas Electronics products in compliance with all these applicable laws and regulations. Renesas Electronics disclaims any and all liability for damages or losses occurring as a result of your noncompliance with applicable laws and regulations.
9. Renesas Electronics products and technologies shall not be used for or incorporated into any products or systems whose manufacture, use, or sale is prohibited under any applicable domestic or foreign laws or regulations. You shall comply with any applicable export control laws and regulations promulgated and administered by the governments of any countries asserting jurisdiction over the parties or transactions.
10. It is the responsibility of the buyer or distributor of Renesas Electronics products, or any other party who distributes, disposes of, or otherwise sells or transfers the product to a third party, to notify such third party in advance of the contents and conditions set forth in this document.
11. This document shall not be reprinted, reproduced or duplicated in any form, in whole or in part, without prior written consent of Renesas Electronics.
12. Please contact a Renesas Electronics sales office if you have any questions regarding the information contained in this document or Renesas Electronics products.
(Note 1) "Renesas Electronics" as used in this document means Renesas Electronics Corporation and also includes its directly or indirectly controlled subsidiaries.
(Note 2) "Renesas Electronics product(s)" means any product developed or manufactured by or for Renesas Electronics.

(Rev.4.0-1 November 2017)



SALES OFFICES

Renesas Electronics Corporation

<http://www.renesas.com>

Refer to "<http://www.renesas.com/>" for the latest and detailed information.

Renesas Electronics America Inc.
1001 Murphy Ranch Road, Milpitas, CA 95035, U.S.A.
Tel: +1-408-432-8888, Fax: +1-408-434-5351

Renesas Electronics Canada Limited
9251 Yonge Street, Suite 8309 Richmond Hill, Ontario Canada L4C 9T3
Tel: +1-905-237-2004

Renesas Electronics Europe Limited
Dukes Meadow, Millboard Road, Bourne End, Buckinghamshire, SL8 5FH, U.K.
Tel: +44-1628-651-700, Fax: +44-1628-651-804

Renesas Electronics Europe GmbH
Arcadiastrasse 10, 40472 Düsseldorf, Germany
Tel: +49-211-6503-0, Fax: +49-211-6503-1327

Renesas Electronics (China) Co., Ltd.
Room 1709 Quantum Plaza, No.27 ZhichunLu, Haidian District, Beijing, 100191 P. R. China
Tel: +86-10-8235-1155, Fax: +86-10-8235-7679

Renesas Electronics (Shanghai) Co., Ltd.
Unit 301, Tower A, Central Towers, 555 Langao Road, Putuo District, Shanghai, 200333 P. R. China
Tel: +86-21-2226-0888, Fax: +86-21-2226-0999

Renesas Electronics Hong Kong Limited
Unit 1601-1611, 16/F., Tower 2, Grand Century Place, 193 Prince Edward Road West, Mongkok, Kowloon, Hong Kong
Tel: +852-2265-6688, Fax: +852-2886-9022

Renesas Electronics Taiwan Co., Ltd.
13F, No. 363, Fu Shing North Road, Taipei 10543, Taiwan
Tel: +886-2-8175-9600, Fax: +886-2-8175-9670

Renesas Electronics Singapore Pte. Ltd.
80 Bendemeer Road, Unit #06-02 Hyflux Innovation Centre, Singapore 339949
Tel: +65-6213-0200, Fax: +65-6213-0300

Renesas Electronics Malaysia Sdn.Bhd.
Unit 1207, Block B, Menara Amcorp, Amcorp Trade Centre, No. 18, Jln Persiaran Barat, 46050 Petaling Jaya, Selangor Darul Ehsan, Malaysia
Tel: +60-3-7955-9390, Fax: +60-3-7955-9510

Renesas Electronics India Pvt. Ltd.
No.777C, 100 Feet Road, HAL 2nd Stage, Indiranagar, Bangalore 560 038, India
Tel: +91-80-67208700, Fax: +91-80-67208777

Renesas Electronics Korea Co., Ltd.
17F, KAMCO Yangjae Tower, 262, Gangnam-daero, Gangnam-gu, Seoul, 06265 Korea
Tel: +82-2-558-3737, Fax: +82-2-558-5338