

RZ/V2H Evaluation Board Kit (Secure type)

Hardware Manual

All information contained in these materials, including products and product specifications, represents information on the product at the time of publication and is subject to change by Renesas Electronics Corp. without notice. Please review the latest information published by Renesas Electronics Corp. through various means, including the Renesas Electronics Corp. website (<http://www.renesas.com>).

Notice

1. Descriptions of circuits, software and other related information in this document are provided only to illustrate the operation of semiconductor products and application examples. You are fully responsible for the incorporation or any other use of the circuits, software, and information in the design of your product or system. Renesas Electronics disclaims any and all liability for any losses and damages incurred by you or third parties arising from the use of these circuits, software, or information.
2. Renesas Electronics hereby expressly disclaims any warranties against and liability for infringement or any other claims involving patents, copyrights, or other intellectual property rights of third parties, by or arising from the use of Renesas Electronics products or technical information described in this document, including but not limited to, the product data, drawings, charts, programs, algorithms, and application examples.
3. No license, express, implied or otherwise, is granted hereby under any patents, copyrights or other intellectual property rights of Renesas Electronics or others.
4. You shall be responsible for determining what licenses are required from any third parties, and obtaining such licenses for the lawful import, export, manufacture, sales, utilization, distribution or other disposal of any products incorporating Renesas Electronics products, if required.
5. You shall not alter, modify, copy, or reverse engineer any Renesas Electronics product, whether in whole or in part. Renesas Electronics disclaims any and all liability for any losses or damages incurred by you or third parties arising from such alteration, modification, copying or reverse engineering.
6. Renesas Electronics products are classified according to the following two quality grades: "Standard" and "High Quality". The intended applications for each Renesas Electronics product depends on the product's quality grade, as indicated below.

"Standard": Computers; office equipment; communications equipment; test and measurement equipment; audio and visual equipment; home electronic appliances; machine tools; personal electronic equipment; industrial robots; etc.

"High Quality": Transportation equipment (automobiles, trains, ships, etc.); traffic control (traffic lights); large-scale communication equipment; key financial terminal systems; safety control equipment; etc.

Unless expressly designated as a high reliability product or a product for harsh environments in a Renesas Electronics data sheet or other Renesas Electronics document, Renesas Electronics products are not intended or authorized for use in products or systems that may pose a direct threat to human life or bodily injury (artificial life support devices or systems; surgical implantations; etc.), or may cause serious property damage (space system; undersea repeaters; nuclear power control systems; aircraft control systems; key plant systems; military equipment; etc.). Renesas Electronics disclaims any and all liability for any damages or losses incurred by you or any third parties arising from the use of any Renesas Electronics product that is inconsistent with any Renesas Electronics data sheet, user's manual or other Renesas Electronics document.

7. No semiconductor product is absolutely secure. Notwithstanding any security measures or features that may be implemented in Renesas Electronics hardware or software products, Renesas Electronics shall have absolutely no liability arising out of any vulnerability or security breach, including but not limited to any unauthorized access to or use of a Renesas Electronics product or a system that uses a Renesas Electronics product. RENESAS ELECTRONICS DOES NOT WARRANT OR GUARANTEE THAT RENESAS ELECTRONICS PRODUCTS, OR ANY SYSTEMS CREATED USING RENESAS ELECTRONICS PRODUCTS WILL BE INVULNERABLE OR FREE FROM CORRUPTION, ATTACK, VIRUSES, INTERFERENCE, HACKING, DATA LOSS OR THEFT, OR OTHER SECURITY INTRUSION ("Vulnerability Issues"). RENESAS ELECTRONICS DISCLAIMS ANY AND ALL RESPONSIBILITY OR LIABILITY ARISING FROM OR RELATED TO ANY VULNERABILITY ISSUES. FURTHERMORE, TO THE EXTENT PERMITTED BY APPLICABLE LAW, RENESAS ELECTRONICS DISCLAIMS ANY AND ALL WARRANTIES, EXPRESS OR IMPLIED, WITH RESPECT TO THIS DOCUMENT AND ANY RELATED OR ACCOMPANYING SOFTWARE OR HARDWARE, INCLUDING BUT NOT LIMITED TO THE IMPLIED WARRANTIES OF MERCHANTABILITY, OR FITNESS FOR A PARTICULAR PURPOSE.
8. When using Renesas Electronics products, refer to the latest product information (data sheets, user's manuals, application notes, "General Notes for Handling and Using Semiconductor Devices" in the reliability handbook, etc.), and ensure that usage conditions are within the ranges specified by Renesas Electronics with respect to maximum ratings, operating power supply voltage range, heat dissipation characteristics, installation, etc. Renesas Electronics disclaims any and all liability for any malfunctions, failure or accident arising out of the use of Renesas Electronics products outside of such specified ranges.
9. Although Renesas Electronics endeavors to improve the quality and reliability of Renesas Electronics products, semiconductor products have specific characteristics, such as the occurrence of failure at a certain rate and malfunctions under certain use conditions. Unless designated as a high reliability product or a product for harsh environments in a Renesas Electronics data sheet or other Renesas Electronics document, Renesas Electronics products are not subject to radiation resistance design. You are responsible for implementing safety measures to guard against the possibility of bodily injury, injury or damage caused by fire, and/or danger to the public in the event of a failure or malfunction of Renesas Electronics products, such as safety design for hardware and software, including but not limited to redundancy, fire control and malfunction prevention, appropriate treatment for aging degradation or any other appropriate measures. Because the evaluation of microcomputer software alone is very difficult and impractical, you are responsible for evaluating the safety of the final products or systems manufactured by you.
10. Please contact a Renesas Electronics sales office for details as to environmental matters such as the environmental compatibility of each Renesas Electronics product. You are responsible for carefully and sufficiently investigating applicable laws and regulations that regulate the inclusion or use of controlled substances, including without limitation, the EU RoHS Directive, and using Renesas Electronics products in compliance with all these applicable laws and regulations. Renesas Electronics disclaims any and all liability for damages or losses occurring as a result of your noncompliance with applicable laws and regulations.
11. Renesas Electronics products and technologies shall not be used for or incorporated into any products or systems whose manufacture, use, or sale is prohibited under any applicable domestic or foreign laws or regulations. You shall comply with any applicable export control laws and regulations promulgated and administered by the governments of any countries asserting jurisdiction over the parties or transactions.
12. It is the responsibility of the buyer or distributor of Renesas Electronics products, or any other party who distributes, disposes of, or otherwise sells or transfers the product to a third party, to notify such third party in advance of the contents and conditions set forth in this document.
13. This document shall not be reprinted, reproduced or duplicated in any form, in whole or in part, without prior written consent of Renesas Electronics.
14. Please contact a Renesas Electronics sales office if you have any questions regarding the information contained in this document or Renesas Electronics products.

(Note1) "Renesas Electronics" as used in this document means Renesas Electronics Corporation and also includes its directly or indirectly controlled subsidiaries.

(Note2) "Renesas Electronics product(s)" means any product developed or manufactured by or for Renesas Electronics.

(Rev.5.0-1 October 2020)

Corporate Headquarters

TOYOSU FORESIA, 3-2-24 Toyosu,
Koto-ku, Tokyo 135-0061, Japan
www.renesas.com

Contact information

For further information on a product, technology, the most up-to-date version of a document, or your nearest sales office, please visit:
www.renesas.com/contact/

Trademarks

Renesas and the Renesas logo are trademarks of Renesas Electronics Corporation. All trademarks and registered trademarks are the property of their respective owners.

Trademarks (continued)

Examples of trademarks or registered trademarks used in the document of RZ/V2H:

Arm® is a registered trademark of Arm Limited or its subsidiaries.

MIPI® is a registered trademark of MIPI Alliance, Inc.

CSI-2® is a registered trademark of MIPI Alliance, Inc.

DSI® is a registered trademark of MIPI Alliance, Inc.

eMMC™ is a registered trademark of MultiMediaCard Association.

PCIe® is a registered trademark of PCI-SIG, Inc.

HDMI® is a registered trademark of HDMI Licensing, LLC.

Pmod™ is a registered trademark of Digilent Inc.

Note that in each section of the Manual, trademark notation of ® and TM may be omitted.

All other trademarks and registered trademarks are the property of their respective owners.

SAFETY MATTERS

Definitions of Symbols

A variety of symbols are used in this document and on this product, to prevent the damage to harm and the property to you and other people beforehand by correctly using this product.

This section, Safety Matters, presents these symbols and their meanings. It also presents safety notes to assure that this produce is used safely and correctly.

This product should only be used after fully understanding the material presented in this section.



WARNING

Warning items indicate things that, if not avoided, could lead to death or serious injury.



CAUTION

Caution items indicate things that, if not avoided, could lead injury or damage to the house and household goods, etc.

In addition to the above two symbols, the following are displayed at the same time as required.

[Important] These indicate the points which may cause a breakdown or malfunction of equipment by the incorrect setting when setting up this product.

△ indicates WARNING or CAUTION.

Example:



CAUTION AGAINST ELECTRIC SHOCK

⊘ indicates PROHIBITION.

Example:



DISASSEMBLY PROHIBITED

● indicates a COMPULSORY ACTION.

Example:



COMPULSORY ACTION



WARNING

Handling Related Warnings:



Always check the jumper and switch settings before connecting a power source. An incorrect jumper or switch setting can lead to internal heat generation, rupture, ignition, or damage to this evaluation board itself or any connected equipment.

If, during either the use or storage of this product, any abnormality in the product itself (including abnormal odors, heating, color changes, or changes to the shape of the product) are observed, disconnect the power supply immediately.

The incidence of such an abnormality may result in rupture, ignition, or performance deterioration. Therefore, do not use this product in such a situation.

Installation:



Do not install this product in a location that has a high humidity or where water or other fluids could get on it. This product may be damaged if water or other fluids can get on it.

Ambient Temperature:



The ambient temperature range for using this product is from 0°C to 60°C.

 CAUTION

Handling:



This product must be handled carefully. Do not cause a strong impact by dropping it, letting it fall, etc.

Do not touch this product's component pins with bare hands. Doing so may discharge static electricity that damages the Internal circuits. Eliminate static electricity before touching this product.

When connecting or disconnecting cables to or from this product, hold the parts of the cable intended to be grasped (such as the plugs) and avoid putting stress on the cable. Do not pull this product etc. while it is connected with a communications interface cable. Doing so may cause the cable to be disconnected.

When connecting a cable to a connector, do not insert the plug in the reverse direction or upside down. Incorrect insertion may damage this product or connected equipment.

Always check the jumper and switch settings before connecting a power source. An incorrect jumper or switch setting can lead to damage to this product or connected equipment.

Do not handle this product with wet hands. Doing so can lead to failure of the product.

Transport methods:



When transporting this product, use the product's packing box and cushioning materials and ship it with precision equipment handling. If the products packing is insufficient, it may be damaged during shipping.

If it must be transported by some other method, pack it carefully as precision equipment.

When packing this product, always use the antistatic pouch included with this product.

If some other pouch is used, electrostatic discharge may damage the product.

Abnormal operation:



If operation of this product becomes abnormal due to interference from external noise etc., apply the following procedure.

1. Turn off the power.
2. Wait 10 or over seconds and then turn the power back on.

Disposal:



When disposing of this product, be sure to dispose it as industrial waste according to all applicable laws.

Table of Contents

1. Overview	9
1.1 Features.....	10
1.2 Block Configuration.....	11
1.3 Specifications.....	13
1.3.1 V2HEVK Specifications.....	13
1.3.2 V2HEVK Power Supply Specifications	14
1.3.3 V2HEVK Accessories	14
1.3.4 Outer Appearance.....	14
1.3.5 List of Pin Functions.....	15
1.4 Usage Notes	18
1.4.1 Turning V2HEVK Power On/Off.....	18
1.4.2 Note on Use of Ethernet	18
2. Operating Procedure	19
2.1 Assembly	19
2.2 Mode Setting.....	20
2.3 Power Supply.....	21
3. Layout	22
3.1 Parts Layout.....	22
3.2 Lists of Main Parts	24
4. Interface Specifications	25
4.1 Reset.....	25
4.2 LED	25
4.3 Switches	25
4.4 Debug Serial Interface	26
4.5 Debugger Interface	26
4.6 MIPI CSI-2 Interface	26
4.7 MIPI DSI Interface	28
4.8 USB Interface	28
4.9 Ethernet Interface	28
4.10 SD Card Connector	29
4.11 PCIe Connector	29
4.12 Pin Header.....	29
4.13 Heat-sink Fan Connector.....	31
4.14 USB-PD Connector (Power only)	31
4.15 HDMI Interface.....	31

4.16	Audio Interface.....	31
4.17	Pmod Connector.....	31
5.	Supplementary Note.....	33
5.1	Power Supply ICs of V2HEVK.....	33
5.2	Assembly of Heat-sink.....	33
	Appendix A CPU Board Parts Layout	34
	REVISION HISTORY	36

1. Overview

This board is an evaluation kit for the Arm[®]-based high-end RZ/V2H MPU from Renesas Electronics (RZ/V2H Evaluation Board Kit (Secure type), hereafter V2HEVK). This manual describes the hardware functions of the V2HEVK.

The V2HEVK consists of the RZ/V2H Secure Evaluation Board (CPU board) and the RZ/V2H EVK Expansion Board (EXP board).

Board Name	Overview
RZ/V2H Secure Evaluation Board (CPU board)	<ul style="list-style-type: none"> The RZ/V2H is mounted. Board on which the main functional components for the RZ/V2H are mounted.
RZ/V2H EVK Expansion Board (EXP board)	<ul style="list-style-type: none"> Connected to J1, J2 and J4 on the RZ/V2H Secure Evaluation Board. This board has HDMI, audio, and Pmod interfaces.

The following documents have been prepared for the V2HEVK. Make sure to refer to the latest versions of these documents. For the development environment including software, contact a Renesas Electronics sales representative.

Document Type	Document Title	Document No.	Description
Hardware Manual	RZ/V2H Evaluation Board Kit (Secure type) Hardware Manual	This manual	Hardware specifications of the V2HEVK
User's Manual: Hardware	RZ/V2H Group User's Manual: Hardware	R01UH1032EJ****	RZ/V2H hardware specifications (pin assignments, memory maps, peripheral specifications, electrical characteristics, and timing charts) and descriptions of operation

1.1 Features

This V2HEVK includes the following features.

- LPDDR4X: 64 Gb × 2
- NOR flash: 512 Mb
- MIPI[®] CSI-2[®] connector: 4 ch.
- Gigabit Ethernet interface connector: 2 ch.
- USB3.2 Gen 2 Type-A: 2 ch.
- USB2.0 micro-AB: 1 ch.
- USB2.0 Type-A: 1 ch.
- Micro SD card connector: 2 ch.
- PCIe[®] Slot (× 4 lanes): 1 ch.
- Debug serial interface USB micro-B: 1 ch.
- Debugger interface connector: 1 ch.
- HDMI[®] Type-A connector: 1 ch.
- Pmod[™] interface connector: 4 ch.
- Audio MIC connector: 1 ch.
- Audio HP connector: 1 ch.
- Audio AUX connector: 1 ch.
- USB-PD Type-C (power supply): 1 ch.

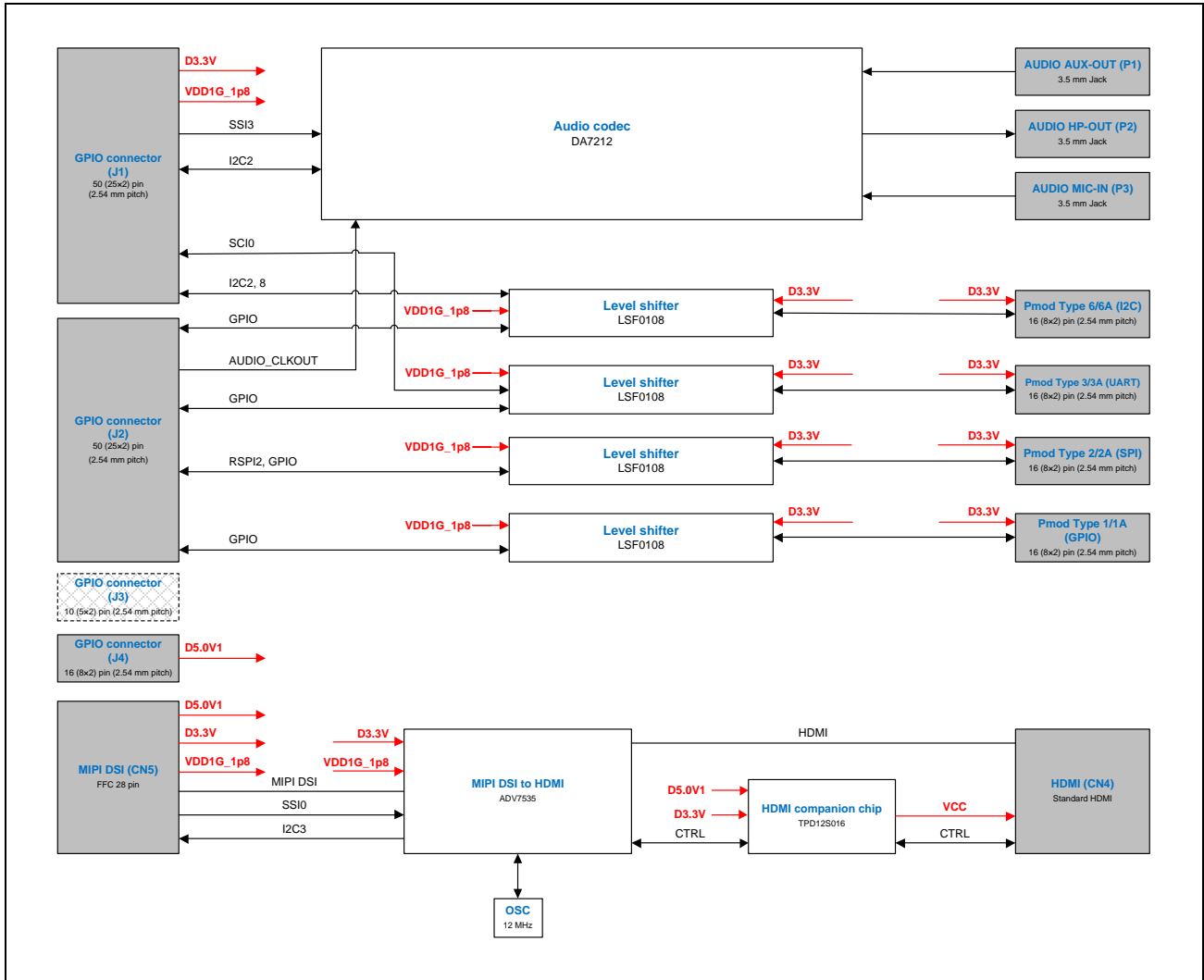

Figure 1.2-2 RZ/V2H EVK Expansion Board Block Diagram

1.3 Specifications

1.3.1 V2HEVK Specifications

Table 1.3-1 V2HEVK Specifications

Item	Specification
MPU	R9A09G057H48GBG (RZ/V2H [GE3D, security, ISP])
Board size	CPU board: 153 × 100 × 1.7 mm EXP board: 153 × 100 × 1.7 mm
LPDDR4X	Micron MT53E2G32D4DE-046 AIT:C (MT53E2G32D4DE-046 WT:C) 64 Gb dual-rank
NOR Flash	Micron MT25QU512ABB8E12
HDMI interface	Connector: Type-A (standard) MIPI® DSI® receiver with HDMI transmitter: ADV7535
USB interface	Connector: USB3.2 Gen2 Type-A × 2 ch. Connector: USB2.0 micro-AB Connector: USB2.0 Type-A
Ethernet interface	Connector: RJ45 × 2 Ethernet PHY IC: KSZ9131RNXI
Audio interface	Connector: 3.5 mm jack (MIC) Connector: 3.5 mm jack (HP) Connector: 3.5 mm jack (AUX-IN)
SD Card interface	Connector: Micro SD card slot × 2 ch.
PCIe interface	Connector: PCIe Slot (× 4 lanes)
MIPI CSI-2 interface	Connector: CF20221V0R0-NH × 4 ch.
Pmod interface	Pmod Type 1A (GPIO) Pmod Type 2A (SPI) Pmod Type 3A (UART) Pmod Type 6A (I2C)
Debug interface	Connector: USB Micro-B UART-USB bridge: FT230XS
Debugger interface	Connector: 10 pins with 1.27 mm pitch
LED	For power enable (PMIC_PWRON): Green For power supply (D5.0V1): Green For power supply (VDD1G_1p8): Green For power supply (S1.8V): Green For power supply (USBC_VBUS_OUT): Green For monitor: Yellow × 2
Switch	For mode setting: 8-bit DIP switch For audio clock select: 6-bit DIP switch For power ON/OFF: Slide switch For PMIC ON/OFF: Slide switch For NMI: Push switch For MIPI CSI-2 Camera Interface voltage selection: DIP switch For MIPI CSI-2 I2C Pull-Up ON/OFF: 8-bit DIP switch
Power supply	USB-PD Type-C (100 W)

1.3.2 V2HEVK Power Supply Specifications

The exact power required for the V2HEVK depends on the application and peripheral devices. **Table 1.3-2** shows the power allocations.

This board is designed to be supplied by a USB power supply that complies with the USB Power Delivery standard of 100 W. Be sure to use a USB power supply of 100 W.

Table 1.3-2 Power Supply Allocation

Item	Power	Description
RZ/V2H	Max. 20 W	LSI maximum power consumption (in the worst conditions)
MIPI CSI-2	Max. 6 W	When connecting four camera modules
USB	Max. 14 W	USB2.0: 2 ch. USB3.2: 2 ch.
PCIe	Max. 25 W	4 lanes x 1 ch.
Others	Max. 8 W	LPDDR4X: 2 ch., GbE_PHY: 2 ch., SD: 2 ch., SPI flash memory, etc.

1.3.3 V2HEVK Accessories

Table 1.3-3 V2HEVK Accessories

Item	Specification
Flexible flat cable (FFC)	Length: 64.2 mm, Width: 14.5 mm, 28 pins <i>Note: Used to connect CN11 on the CPU board and CN5 on the EXP board</i>
Heat-sink	40 × 40 × 20 mm with fan
USB cable	Type-A – Micro-B Length: 1 m
Rubber feet	D = 8 mm, t = 2.79 mm, Qty: 4

1.3.4 Outer Appearance

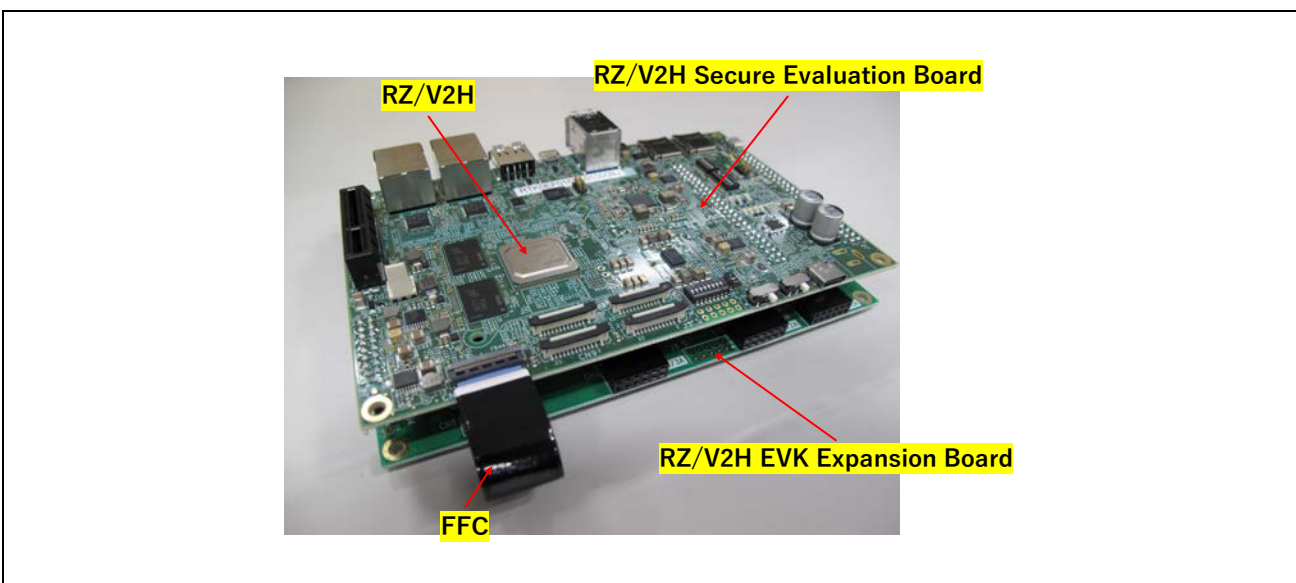

Figure 1.3-1 Outer Appearance of V2HEVK

1.3.5 List of Pin Functions

Table 1.3-4 lists pin functions used in V2HEVK.

Table 1.3-4 List of Pin Function Selection Used on the V2HEVK (1/3)

Pin Location	Pin Name	Pin Function	Description
AU8	P00	P00/LED	Switching LD5 via EXP board
AT8	P01	P01/LED	Switching LD6 via EXP board
AP9	P02	P02	J1 connector on the CPU board
AR9	P03	P03	J1 connector on the CPU board
AN9	P04	SSI3_SDATA	Audio codec (DA7212) on the EXP board
AU10	P05	P05	J1 connector on the CPU board
AP10	P06	SDA8	RAA215300 / DA9141 / 5L35023B on the CPU board
AR10	P07	SCL8	RAA215300 / DA9141 / 5L35023B on the CPU board
AP11	P10	AUDIO_CLKB	5L35023B / J1 connector on the CPU board DSW2(SW2) ON: Audio_CLKB is supplied from 5L35023B OFF: Audio_CLKB is not supplied from 5L35023B
AU9	P11	AUDIO_CLKC	5L35023B / J1 connector on the CPU board DSW2(SW4) ON: Audio_CLKC is supplied from 5L35023B OFF: Audio_CLKC is not supplied from 5L35023B
AR11	P12	SSI3_SCK	Audio codec (DA7212) on the EXP board
AT9	P13	SSI3_WS	Audio codec (DA7212) on the EXP board
AT11	P14	P14	J1 connector on the CPU board
AM9	P15	SSI4_SDATA	Audio codec (DA7212) on the EXP board
AN11	P20	SDA2	PCIe slot on the CPU Board and Pmod Type6/6A (I2C) connector / DA7212 on the EXP Board
AU11	P21	SCL2	PCIe slot on the CPU Board and Pmod Type6/6A (I2C) connector / DA7212 on the EXP Board
AU17	P30	SDA0	MIPI CSI-2 CH0 (CN7) / J1 connector on the CPU board
AR18	P31	SCL0	MIPI CSI-2 CH0 (CN7) / J1 connector on the CPU board
AR17	P32	SDA1	MIPI CSI-2 CH1 (CN8) / J1 connector on the CPU board
AM18	P33	SCL1	MIPI CSI-2 CH1 (CN8) / J1 connector on the CPU board
AP19	P34	P34	J1 connector on the CPU board
AT17	P35	P35	J1 connector on the CPU board
AN18	P36	SDA3	MIPI DSI (CN11) / J1 connector on the CPU board
AR19	P37	SCL3	MIPI DSI (CN11) / J1 connector on the CPU board
AM19	P40	SSI0_SCK	MIPI DSI (CN11) / J1 connector on the CPU board
AP18	P41	SSI0_WS	MIPI DSI (CN11) / J1 connector on the CPU board
AT18	P42	SSI0_SDATA	MIPI DSI (CN11) / J1 connector on the CPU board
AP17	P43	P43	J1 connector on the CPU board
AU18	P44	SDA6	MIPI CSI-2 CH2 (CN9) / J1 connector on the CPU board
AM17	P45	SCL6	MIPI CSI-2 CH2 (CN9) / J1 connector on the CPU board
AN17	P46	SDA7	MIPI CSI-2 CH3 (CN10) / J1 connector on the CPU board
AU19	P47	SCL7	MIPI CSI-2 CH3 (CN10) / J1 connector on the CPU board
AT20	P50	TXD0	Pmod Type3/3A (UART) connector on the EXP board
AN21	P51	RXD0	Pmod Type3/3A (UART) connector on the EXP board
AP22	P52	CTS0N	Pmod Type3/3A (UART) connector on the EXP board

Table 1.3-4 List of Pin Function Selection Used on the V2HEVK (2/3)

Pin Location	Pin Name	Pin Function	Description
AU20	P53	RTSON	Pmod Type3/3A (UART) connector on the EXP board
AM20	P54	P54	Pmod Type6/6A (I2C) connector on the EXP board
AR22	P55	P55	Pmod Type6/6A (I2C) connector on the EXP board
AN20	P56	P56	J2 connector on the CPU board
AR21	P57	P57	Pmod Type3/3A (UART) connector on the EXP board
AP20	P60	P60/CAM3_PWR	MIPI CSI-2 CH3 (CN10) / J1 connector on the CPU board
AR20	P61	P61/CAM2_PWR	MIPI CSI-2 CH2 (CN9) / J1 connector on the CPU board
AM22	P62	USB31_VBUSEN	USB31 VBUS enable / J2 connector on the CPU board
AU22	P63	USB31_OVRCUR	USB31 overcurrent detect / J2 connector on the CPU board
AU21	P64	P64/CAM0_RST#	MIPI CSI-2 CH0 (CN7) / J2 connector on the CPU board
AM21	P65	P65/CAM1_RST#	MIPI CSI-2 CH1 (CH8) / J2 connector on the CPU board
AP21	P66	USB21_VBUSEN	USB21 VBUS enable / J2 connector on the CPU board
AT21	P67	USB21_OVRCUR	USB21 overcurrent detect / J2 connector on the CPU board
AR26	P70	P70/IRQ0	Pmod Type6/6A (I2C) connector on the EXP board
AU24	P71	P71/IRQ1/HDMI_INT#	MIPI DSI (CN11) / J2 connector on the CPU board
AM25	P72	P72/IRQ4	Pmod Type6/6A (I2C) connector on the EXP board
AP25	P73	P73	Pmod Type3/3A (UART) connector on the EXP board
AM23	P74	P74/IRQ8	Pmod Type2/2A (SPI) connector on the EXP board
AR25	P75	P75	Pmod Type2/2A (SPI) connector on the EXP board
AT25	P76	P76	Pmod Type3/3A (UART) connector on the EXP board
AM24	P77	P77	Pmod Type3/3A (UART) connector on the EXP board
AN23	P80	P80	Pmod Type1/1A (GPIO) connector on the EXP board
AP23	P81	P81	Pmod Type1/1A (GPIO) connector on the EXP board
AT23	P82	P82	Pmod Type1/1A (GPIO) connector on the EXP board
AN24	P83	P83	Pmod Type1/1A (GPIO) connector on the EXP board
AR24	P84	P84	Pmod Type1/1A (GPIO) connector on the EXP board
AP24	P85	P85	Pmod Type1/1A (GPIO) connector on the EXP board
AU23	P86	P86	Pmod Type1/1A (GPIO) connector on the EXP board
AR23	P87	P87	Pmod Type1/1A (GPIO) connector on the EXP board
AP30	P90	P90	Pmod Type6/6A (I2C) connector on the EXP board
AM31	P91	P91	Pmod Type6/6A (I2C) connector on the EXP board
AN30	P92	P92/CAM2_RST#	MIPI CSI-2 CH2 (CN9) / J1 connector on the CPU board
AM30	P93	P93/CAM3_RST#	MIPI CSI-2 CH3 (CN10) / J1 connector on the CPU board
AM29	P94	SD1CD	SD0/1 card detect / J2 connector on the CPU board
AR30	P95	USB20_VBUSEN	USB20 VBUS enable / J2 connector on the CPU board
AN31	P96	USB20_OVRCURN	USB20 overcurrent detect / J2 connector on the CPU board
AN29	P97	AUDIO_CLKOUT	Audio codec (DA7212) on the EXP board
AM28	PA0	SD0IOVS	SD0 IO voltage select / J2 connector on the CPU board
AP28	PA1	PA1/SD0PWEN	SD0 power enable (disconnected) / J2 connector on the CPU board
AP27	PA2	SD1IOVS	SD1 IO voltage select / J2 connector on the CPU board
AR29	PA3	SD1PWEN	SD1 power enable / J2 connector on the CPU board
AN28	PA4	PA4/SSLC3	Pmod Type2/2A (SPI) connector on the EXP board
AM27	PA5	SD0CD	SD0 card detect / J2 connector on the CPU board
AR28	PA6	PA6/SSLC1	Pmod Type2/2A (SPI) connector on the EXP board

Table 1.3-4 List of Pin Function Selection Used on the V2HEVK (3/3)

Pin Location	Pin Name	Pin Function	Description
AP29	PA7	PA7/SD1CD/SSLC0	SD1 card detect (disconnected) on the CPU board and Pmod Type2/2A (SPI) connector on the EXP board
AR32	PB0	USB30_VBUSEN	USB30 VBUS enable / J2 connector on the CPU board
AN33	PB1	USB30_OVRCUR	USB30 overcurrent detect / J2 connector on the CPU board
AR31	PB2	PB2/CAM0&1_PWR#	MIPI CSI-2 CH0 (CN7) / MIPI CSI-2 CH1 (CN8) / J2 connector on the CPU board
AP33	PB3	MISOC	Pmod Type2/2A (SPI) connector on the EXP board
AP32	PB4	MOSIC	Pmod Type2/2A (SPI) connector on the EXP board
AR33	PB5	RSPCKC	Pmod Type2/2A (SPI) connector on the EXP board

1.4 Usage Notes

1.4.1 Turning V2HEVK Power On/Off

- Take sufficient care with setting up switches on the V2HEVK. Incorrect settings may lead to damage to devices.
- The RZ/V2H has the power-on and power-off sequences. With the V2HEVK, be sure to follow the precautions below.

(1) When turning power on

Be sure to check that the power slide switches SW2 and SW3 are turned off before connecting the USB Type-C cable to the Type-C connector (CN13).

Connecting the USB Type-C cable to the Type-C connector while the power supply slide switches SW2 and SW3 are on is prohibited.

(2) When turning power off

Be sure to execute the power-off sequence*¹ by software before turning the power supply slide switches SW2 and SW3 off. After the power-off sequence by software, turn these slide switches off and remove the USB Type-C cable from the Type-C connector (CN13). Removing the USB Type-C cable from the Type-C connector while the power supply slide switches SW2 and SW3 are on is prohibited. Doing so may lead to damage to devices.

Note 1. For power-off sequence, refer to the *RZ/V2H Group User's Manual: Hardware*.

1.4.2 Note on Use of Ethernet

The gigabit Ethernet interface connectors (CN5, CN6) must not be connected to a public line. Connection with a public line is not supported. Note that the MAC address is not set in this evaluation kit.

2. Operating Procedure

2.1 Assembly

The CPU board and the EXP board are connected by stacking with J1, J2 and J4. The MIPI DSI interface is connected with a dedicated FFC. For safety, attach the included rubber feet to the back of the EXP board.

Connect the FFC using the following procedure:

1. Open the FFC locking cover, align the FFC contacts to the bottom, and close the cover until it locks. The cover is fragile, so handle with care.

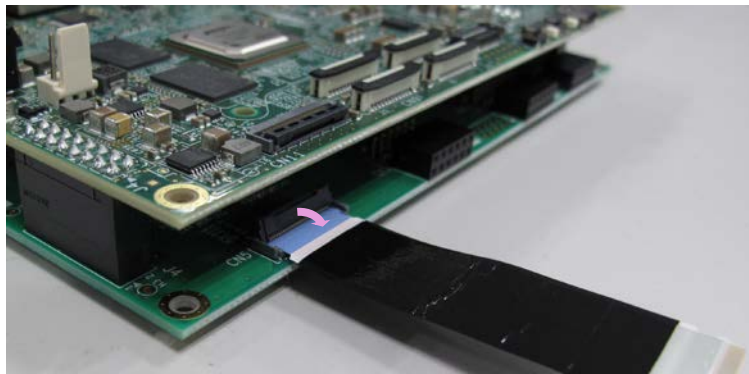

Figure 2.1-1 Connect FFC to RZ/V2H EVK Expansion Board

2. Connect the FFC to the CPU board.



Figure 2.1-2 Connect FFC to RZ/V2H Secure Evaluation Board

2.2 Mode Setting

The table below lists the settings of the DIP switch (DSW1 on the RZ/V2H Secure Evaluation Board) and its functions.

Table 2.2-1 DSW1 Connection Destinations and Functions

Switch No.	RZ/V2H Pin	Function
1	BOOTSELCPU	Select the cold boot CPU OFF: CM33, ON: CA55 (default)
2	BOOTPLLCA1	Input the CA55 frequency at the CA55 cold boot
3	BOOTPLLCA0	BOOTPLLCA[1:0] = [OFF:OFF]: 1.6 GHz = [OFF:ON]: 1.7 GHz (default) = [ON:OFF]: 1.1 GHz = [ON:ON]: 1.5 GHz
4	MD_BOOT1	Input the boot mode select signal
5	MD_BOOT0	MD_BOOT[1:0] = [OFF:OFF]: xSPI = [OFF:ON]: SCIF = [ON:OFF]: SD (default) = [ON:ON]: eMMC
6	MD_CLKS	OFF: SSCG ON (default), ON: SSCG OFF
7	MD_BOOT3	OFF: Normal mode (default), ON: Debug mode
8	MD_BOOT4	Fixed to OFF

The table below lists the settings of the DIP switch (DSW2 on the RZ/V2H Secure Evaluation Board) and its functions.

Table 2.2-2 DSW2 Functions

Switch No.	Signal Name	Function
1	Audio_CLKB_OE	OFF: Disables Audio_CLKB output of 5L35023B (default) ON: Enables Audio_CLKB output of 5L35023B
2	Audio_CLKB	OFF: Audio_CLKB is not supplied (default) ON: Audio_CLKB is supplied with CLK
3	Audio_CLKC_OE	OFF: Disables Audio_CLKC output of 5L35023B (default) ON: Enables Audio_CLKC output of 5L35023B
4	Audio_CLKC	OFF: Audio_CLKC is not supplied (default) ON: Audio_CLKC is supplied with CLK
5	NEN_VPROG	OFF: Fixed to OFF ON: Setting ON is prohibited
6	—	—

The table below lists the settings of the DIP switch (JSW1 on the RZ/V2H Secure Evaluation Board) and its functions.

Table 2.2-3 JSW1 Functions

Switch	Function
1-2	MIPI CSI-2 camera interface voltage: 1.8 V
2-3	MIPI CSI-2 camera interface voltage: 3.3 V (default)

Note: Set this switch according to the interface voltage of the camera module to be connected.

The table below lists the settings of the DIP switch (DSW3 on the RZ/V2H Secure Evaluation Board) and its functions.

Table 2.2-4 DSW3 Functions

Switch No.	Signal Name	Function
1	I2C0_SCL	OFF: MIPI CSI-2 (ch. 0) SCL signal pull-up OFF ON: MIPI CSI-2 (ch. 0) SCL signal pull-up ON (default)
2	I2C0_SDA	OFF: MIPI CSI-2 (ch. 0) SDA signal pull-up OFF ON: MIPI CSI-2 (ch. 0) SDA signal pull-up ON (default)
3	I2C1_SCL	OFF: MIPI CSI-2 (ch. 1) SCL signal pull-up OFF ON: MIPI CSI-2 (ch. 1) SCL signal pull-up ON (default)
4	I2C1_SDA	OFF: MIPI CSI-2 (ch. 1) SDA signal pull-up OFF ON: MIPI CSI-2 (ch. 1) SDA signal pull-up ON (default)
5	I2C6_SCL	OFF: MIPI CSI-2 (ch. 2) SCL signal pull-up OFF ON: MIPI CSI-2 (ch. 2) SCL signal pull-up ON (default)
6	I2C6_SDA	OFF: MIPI CSI-2 (ch. 2) SDA signal pull-up OFF ON: MIPI CSI-2 (ch. 2) SDA signal pull-up ON (default)
7	I2C7_SCL	OFF: MIPI CSI-2 (ch. 3) SCL signal pull-up OFF ON: MIPI CSI-2 (ch. 3) SCL signal pull-up ON (default)
8	I2C7_SDA	OFF: MIPI CSI-2 (ch. 3) SDA signal pull-up OFF ON: MIPI CSI-2 (ch. 3) SDA signal pull-up ON (default)

Note: If these signals are pulled up in the connected camera modules, turn this switch OFF.

2.3 Power Supply

1. Set up the DIP switches before supplying power.
2. Before connecting the USB Type-C cable, check that the power slide switches SW2 and SW3 are turned off.
3. Connect the USB Type-C cable to CN13 on the RZ/V2H Secure Evaluation Board.
4. When SW3 is turned on, LD2 and LD7 light up.
5. When SW2 is turned on, LD1, LD3, and LD4 light up and the RZ/V2H starts up.

Table 2.3-1 SW2/SW3 Functions

Switch No.	Function	Specifications
SW2	PMIC (RAA215300) ON/OFF	ON: Enables PMIC output OFF: Stops disabling of PMIC output
SW3	USB-PD ON/OFF	ON: Enables USB-PD power output OFF: Disables USB-PD power output

3. Layout

3.1 Parts Layout

Figure 3.1-1 and Figure 3.1-2 show the parts layout diagrams of the RZ/V2H Secure Evaluation Board, and Figure 3.1-3 shows the parts layout diagram of the RZ/V2H EVK Expansion Board.

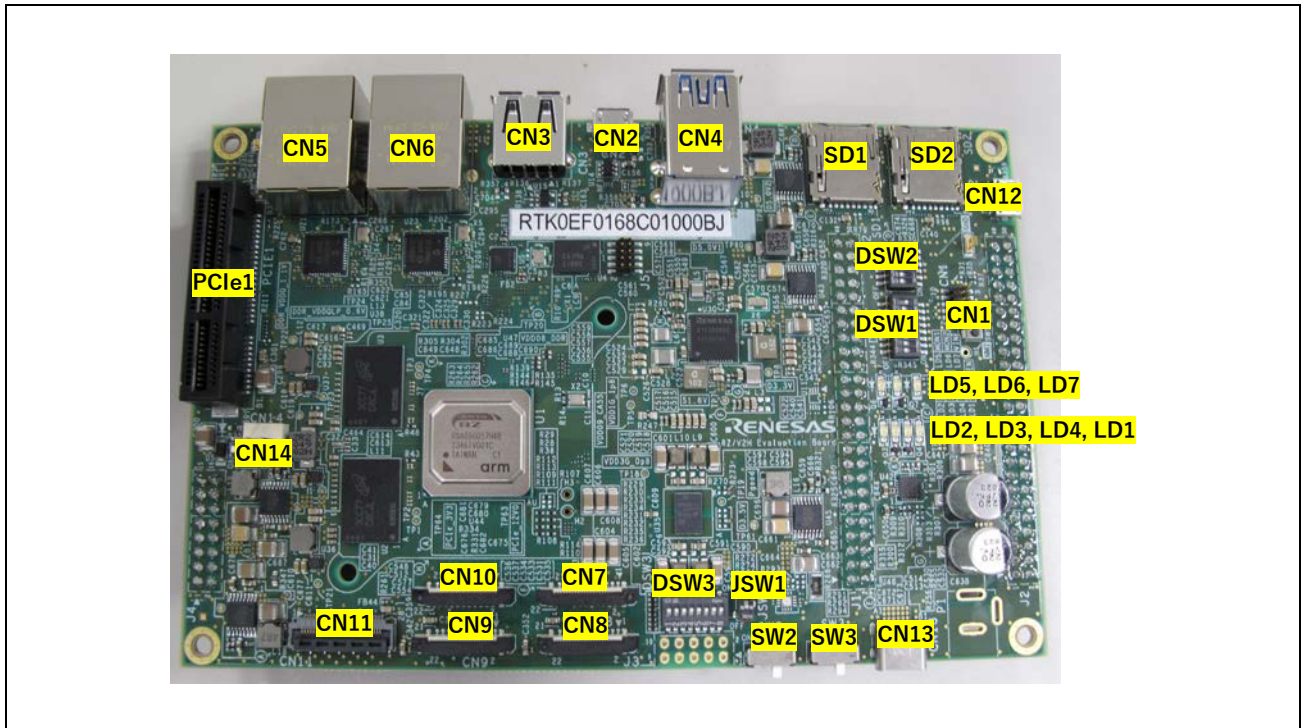

Figure 3.1-1 RZ/V2H Secure Evaluation Board Parts Layout Diagram (Parts Side)



Figure 3.1-2 RZ/V2H Secure Evaluation Board Layout Diagram (Solder Side)

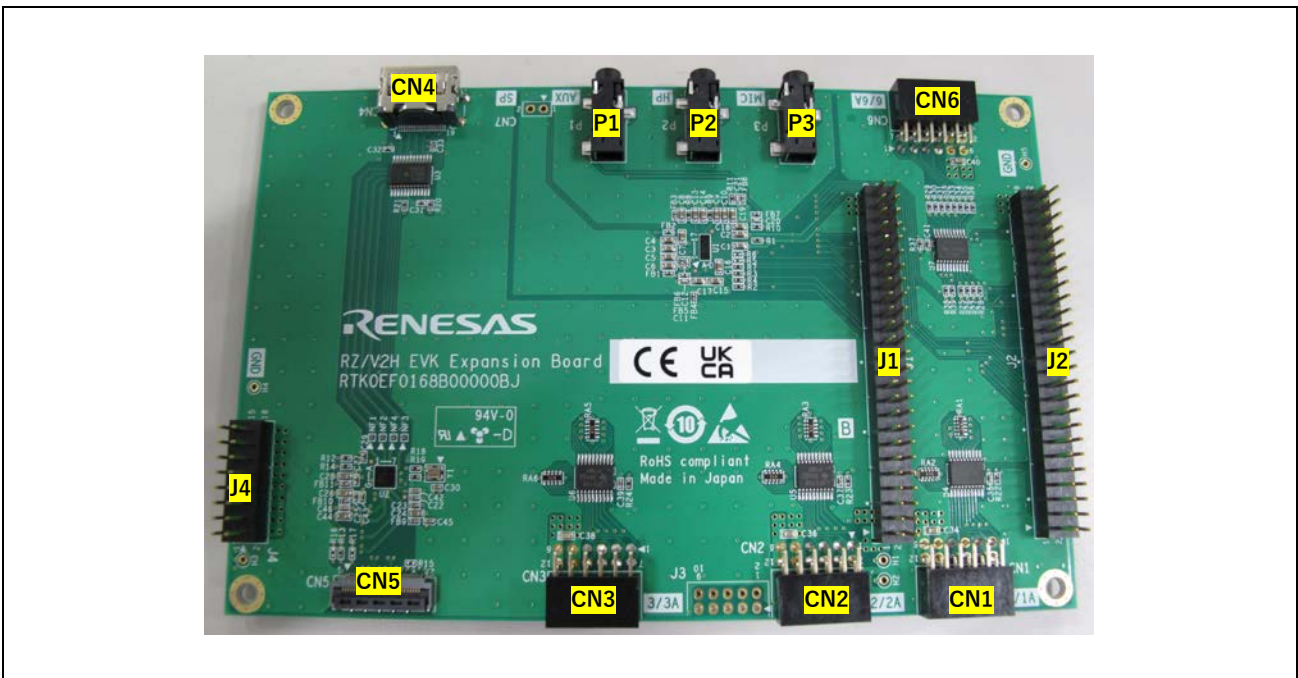

Figure 3.1-3 RZ/V2H EVK Expansion Board Parts Layout Diagram (Parts Side)

3.2 Lists of Main Parts

Table 3.2-1 and **Table 3.2-2** list the main parts of the RZ/V2H Secure Evaluation Board and RZ/V2H EVK Expansion Board, respectively.

Table 3.2-1 RZ/V2H Secure Evaluation Board Parts List

No.	Quantity	Part Symbol	Part Name	Manufacturer
1	1	U1	R9A09G057H48GBG (RZ/V2H)	Renesas Electronics
2	1	U5	5L35023B-616NLGI8	Renesas Electronics
3	1	U6	SLG7RN46898	Renesas Electronics
4	2	U13, U18	ISL61852CCRZ	Renesas Electronics
5	1	U30	RAA215300A2GNP#HA2	Renesas Electronics
6	4	U31, U32, U33, U34	SLG59M1603V	Renesas Electronics
7	1	U50	SLG59M1717V	Renesas Electronics
8	1	U35	DA9141-08F72	Renesas Electronics
9	2	U36, U37	ISL80031A	Renesas Electronics
10	1	U38	ISL80015	Renesas Electronics
11	5	U43, U44, U45, U46, U47	RAA211250GSP#HA0	Renesas Electronics

Table 3.2-2 RZ/V2H EVK Expansion Board Parts List

No.	Quantity	Part Symbol	Part Name	Manufacturer
1	1	U1	DA7212-01UM	Renesas Electronics

4. Interface Specifications

This section describes the interface specifications of the V2HEVK.

4.1 Reset

When resetting the V2HEVK, control it by using the power control switches (SW2, SW3) and software.

4.2 LED

The V2HEVK has seven LEDs. **Table 4.2-1** lists the colors and functions of these LEDs.

Table 4.2-1 RZ/V2H Secure Evaluation Board LEDs

LED	Color	Function/Usage
LD1	Green	PMIC_PWRON indicator
LD2	Green	Power D5.0V1 (5 V) indicator
LD3	Green	Power VDD1G_1p8 (1.8 V) indicator
LD4	Green	Power S1.8V (1.8 V) indicator
LD5	Yellow	Signal monitor
LD6	Yellow	Signal monitor
LD7	Green	Power USBC_VBUS_OUT (20 V) indicator

4.3 Switches

The V2HEVK has seven switches. **Table 4.3-1** lists the functions of the respective switches.

Table 4.3-1 RZ/V2H Secure Evaluation Board Switches

Switch	Shape	Usage
DSW1	DIP switch	Mode setting (see Section 2.2, Mode Setting)
DSW2	DIP switch	Mode setting (see Section 2.2, Mode Setting)
DSW3	DIP switch	Mode setting (see Section 2.2, Mode Setting)
JSW1	DIP switch	Mode setting (see Section 2.2, Mode Setting)
SW1	Push switch	NMI
SW2	Slide switch	Power switch (PMIC_RAA215300 ON/OFF)
SW3	Slide switch	Power switch (USBC_VBUS_OUT 20V ON/OFF)

4.4 Debug Serial Interface

The debugging port (micro USB Type-B connector (CN12)) is connected to the SCIF interface of the RZ/V2H via the USB-UART conversion IC. This port is for use in debugging.

4.5 Debugger Interface

Connect the ICE to the Arm JTAG connector (CN1). For the ICE having confirmed the connection, contact a Renesas Electronics sales representative.

Note: The emulator connector has 10 pins with 1.27-mm pitch.

Table 4.5-1 Arm JTAG Connector (CN1)

Pin No.	V2HEVK Connection Destination	Pin No.	V2HEVK Connection Destination
1	+1.8 V (VDD1G_1p8)	2	RZ/V2H (TMS_SWDIO)
3	GND	4	RZ/V2H (TCK_SWCLK)
5	GND	6	RZ/V2H (TDO)
7	NC	8	RZ/V2H (TDI)
9	RZ/V2H (TRSTN)	10	RZ/V2H (QRESN)

4.6 MIPI CSI-2 Interface

The CPU board of the V2HEVK has four MIPI CSI-2 interfaces.

CAUTION

This interface is different from the Raspberry Pi camera interface. When connecting the Raspberry Pi camera module, carefully confirm each signal connection. Incorrect connections may damage the board or module.

Table 4.6-1 MIPI CSI-2 Connector (CN7)

Pin No.	V2HEVK Connection Destination	Pin No.	V2HEVK Connection Destination
1	GND	12	RZ/V2H (CSI0_DATA2P)
2	RZ/V2H (CSI0_DATA0N)	13	GND
3	RZ/V2H (CSI0_DATA0P)	14	RZ/V2H (CSI0_DATA3N)
4	GND	15	RZ/V2H (CSI0_DATA3P)
5	RZ/V2H (CSI0_DATA1N)	16	GND
6	RZ/V2H (CSI0_DATA1P)	17	RZ/V2H (PB2)
7	GND	18	RZ/V2H (P64)
8	RZ/V2H (CSI0_CLKN)	19	GND
9	RZ/V2H (CSI0_CLKP)	20	RZ/V2H (I2C0_SCL)
10	GND	21	RZ/V2H (I2C0_SDA)
11	RZ/V2H (CSI0_DATA2N)	22	+3.3 V (PCIe_3V3)

Table 4.6-2 MIPI CSI-2 Connector (CN8)

Pin No.	V2HEVK Connection Destination
1	GND
2	RZ/V2H (CSI1_DATA0N)
3	RZ/V2H (CSI1_DATA0P)
4	GND
5	RZ/V2H (CSI1_DATA1N)
6	RZ/V2H (CSI1_DATA1P)
7	GND
8	RZ/V2H (CSI1_CLKN)
9	RZ/V2H (CSI1_CLKP)
10	GND
11	RZ/V2H (CSI1_DATA2N)

Pin No.	V2HEVK Connection Destination
12	RZ/V2H (CSI1_DATA2P)
13	GND
14	RZ/V2H (CSI1_DATA3N)
15	RZ/V2H (CSI1_DATA3P)
16	GND
17	RZ/V2H (PB2)
18	RZ/V2H (P65)
19	GND
20	RZ/V2H (I2C1_SCL)
21	RZ/V2H (I2C1_SDA)
22	+3.3 V (PCIe_3V3)

Table 4.6-3 MIPI CSI-2 Connector (CN9)

Pin No.	V2HEVK Connection Destination
1	GND
2	RZ/V2H (CSI2_DATA0N)
3	RZ/V2H (CSI2_DATA0P)
4	GND
5	RZ/V2H (CSI2_DATA1N)
6	RZ/V2H (CSI2_DATA1P)
7	GND
8	RZ/V2H (CSI2_CLKN)
9	RZ/V2H (CSI2_CLKP)
10	GND
11	RZ/V2H (CSI2_DATA2N)

Pin No.	V2HEVK Connection Destination
12	RZ/V2H (CSI2_DATA2P)
13	GND
14	RZ/V2H (CSI2_DATA3N)
15	RZ/V2H (CSI2_DATA3P)
16	GND
17	RZ/V2H (P61)
18	RZ/V2H (P92)
19	GND
20	RZ/V2H (I2C6_SCL)
21	RZ/V2H (I2C6_SDA)
22	+3.3 V (PCIe_3V3)

Table 4.6-4 MIPI CSI-2 Connector (CN10)

Pin No.	V2HEVK Connection Destination
1	GND
2	RZ/V2H (CSI3_DATA0N)
3	RZ/V2H (CSI3_DATA0P)
4	GND
5	RZ/V2H (CSI3_DATA1N)
6	RZ/V2H (CSI3_DATA1P)
7	GND
8	RZ/V2H (CSI3_CLKN)
9	RZ/V2H (CSI3_CLKP)
10	GND
11	RZ/V2H (CSI3_DATA2N)

Pin No.	V2HEVK Connection Destination
12	RZ/V2H (CSI3_DATA2P)
13	GND
14	RZ/V2H (CSI3_DATA3N)
15	RZ/V2H (CSI3_DATA3P)
16	GND
17	RZ/V2H (P60)
18	RZ/V2H (P93)
19	GND
20	RZ/V2H (I2C7_SCL)
21	RZ/V2H (I2C7_SDA)
22	+3.3 V (PCIe_3V3)

4.7 MIPI DSI Interface

The V2HEVK has a MIPI DSI interface. This interface is connected from the RZ/V2H on the CPU board to CN11 and is connected to CN5 on the EXP board with a dedicated FFC. The EXP board converts MIPI DSI to an HDMI signal and outputs it to the CN4 HDMI connector.

Table 4.7-1 MIPI DSI Connector (CN11)

Pin No.	V2HEVK Connection Destination	Pin No.	V2HEVK Connection Destination
1	RZ/V2H (P37)	16	RZ/V2H (DSI_DNDATA0)
2	RZ/V2H (P41)	17	RZ/V2H (DSI_DPDATA0)
3	RZ/V2H (P40)	18	GND
4	RZ/V2H (P42)	19	RZ/V2H (DSI_DNCLK)
5	RZ/V2H (P36)	20	RZ/V2H (DSI_DPCLK)
6	GND	21	GND
7	RZ/V2H (DSI_DNDATA3)	22	RZ/V2H (P71)
8	RZ/V2H (DSI_DPDATA3)	23	GND
9	GND	24	+1.8 V (VDD1G_1p8)
10	RZ/V2H (DSI_DNDATA2)	25	GND
11	RZ/V2H (DSI_DPDATA2)	26	+3.3 V (D3.3V)
12	GND	27	GND
13	RZ/V2H (DSI_DNDATA1)	28	+5.0 V
14	RZ/V2H (DSI_DPDATA1)	G1-5	GND
15	GND	F1-2	GND

4.8 USB Interface

The CPU board of the V2HEVK has the following USB connectors.

- USB3.2 Gen2 host interface.
The USB Type-A connector (CN4) is connected to the USB 3.2 Gen2 interface of the RZ/V2H.
- USB2.0 host interface.
The USB Type-A connector (CN3) is connected to the USB 2.0 (ch. 1) interface of the RZ/V2H.
- USB2.0 DRD interface.
The USB micro-AB connector (CN2) is connected to the USB 2.0 (ch. 0) interface of the RZ/V2H.

4.9 Ethernet Interface

The CPU board of the V2HEVK has two Ethernet interfaces. The RJ-45 connectors (CN5 and CN6) are connected to the Ethernet interface of the RZ/V2H via the Ethernet PHY IC. Connecting this interface to a public line is prohibited.

4.10 SD Card Connector

The CPU board of the V2HEVK has two micro SD card connectors (SD1 and SD2). These connectors are connected to the SD interface of the RZ/V2H.

SD1 is connected to the SD0 interface of RZ/V2H and can be used as a boot device.

SD2 is set as the SD1 interface of the RZ/V2H.

4.11 PCIe Connector

The CPU board of the V2HEVK has a PCIe connector (PCIe1). This connector is connected to the PCIe interface of the RZ/V2H.

4.12 Pin Header

The CPU board of the V2HEVK has five pin headers. Their connection destinations are listed below.

Table 4.12-1 GPIO CN (J1) (Stacking Connection to EXP Board)

Pin No.	V2HEVK Connection Destination	Pin No.	V2HEVK Connection Destination
1	+3.3 V (D3.3V)	2	GND
3	+1.8 V (VDD_1G_1p8)	4	GND
5	+1.8 V (S1.8V)	6	GND
7	RZ/V2H (P00)	8	P00_LED
9	RZ/V2H (P01)	10	P01_LED
11	RZ/V2H (P02)	12	RZ/V2H (P33)
13	RZ/V2H (P03)	14	RZ/V2H (P34)
15	RZ/V2H (P04)	16	RZ/V2H (P35)
17	RZ/V2H (P05)	18	RZ/V2H (P36)
19	RZ/V2H (P06)	20	RZ/V2H (P37)
21	RZ/V2H (P07)	22	RZ/V2H (P40)
23	RZ/V2H (P10)	24	RZ/V2H (P41)
25	RZ/V2H (P11)	26	RZ/V2H (P11)
27	RZ/V2H (P12)	28	RZ/V2H (P43)
29	RZ/V2H (P13)	30	RZ/V2H (P44)
31	RZ/V2H (P14)	32	RZ/V2H (P45)
33	RZ/V2H (P15)	34	RZ/V2H (P46)
35	RZ/V2H (P20)	36	RZ/V2H (P47)
37	RZ/V2H (P21)	38	RZ/V2H (P50)
39	RZ/V2H (P30)	40	RZ/V2H (P51)
41	RZ/V2H (P31)	42	RZ/V2H (P52)
43	RZ/V2H (P32)	44	RZ/V2H (P53)
45	RZ/V2H (QRESN)	46	RZ/V2H (P54)
47	PMIC_PWRON	48	RZ/V2H (P55)
49	GND	50	GND

Table 4.12-2 GPIO CN (J2) (Stacking Connection to EXP Board)

Pin No.	V2HEVK Connection Destination	Pin No.	V2HEVK Destination
1	RZ/V2H (P56)	2	RZ/V2H (P86)
3	RZ/V2H (P57)	4	RZ/V2H (P87)
5	RZ/V2H (P60)	6	RZ/V2H (P90)
7	RZ/V2H (P61)	8	RZ/V2H (P91)
9	RZ/V2H (P62)	10	RZ/V2H (P92)
11	RZ/V2H (P63)	12	RZ/V2H (P93)
13	RZ/V2H (P64)	14	RZ/V2H (P94)
15	RZ/V2H (P65)	16	RZ/V2H (P95)
17	RZ/V2H (P66)	18	RZ/V2H (P96)
19	RZ/V2H (P67)	20	RZ/V2H (P97)
21	RZ/V2H (P70)	22	RZ/V2H (PA0)
23	RZ/V2H (P71)	24	RZ/V2H (PA1)
25	RZ/V2H (P72)	26	RZ/V2H (P72)
27	RZ/V2H (P73)	28	RZ/V2H (PA3)
29	RZ/V2H (P74)	30	RZ/V2H (PA4)
31	RZ/V2H (P75)	32	RZ/V2H (PA5)
33	RZ/V2H (P76)	34	RZ/V2H (PA6)
35	RZ/V2H (P77)	36	RZ/V2H (PA7)
37	RZ/V2H (P80)	38	RZ/V2H (PB0)
39	RZ/V2H (P81)	40	RZ/V2H (PB1)
41	RZ/V2H (P82)	42	RZ/V2H (PB2)
43	RZ/V2H (P83)	44	RZ/V2H (PB3)
45	RZ/V2H (P84)	46	RZ/V2H (PB4)
47	RZ/V2H (P85)	48	RZ/V2H (PB5)
49	GND	50	GND

Table 4.12-3 AD input CN (J3) [Not implemented]

Pin No.	V2HEVK Connection Destination	Pin No.	V2HEVK Connection Destination
1	+1.8 V (S1.8V)	2	GND
3	RZ/V2H (ANI000)	4	RZ/V2H (ANI004)
5	RZ/V2H (ANI001)	6	RZ/V2H (ANI005)
7	RZ/V2H (ANI002)	8	RZ/V2H (ANI006)
9	RZ/V2H (ANI003)	10	RZ/V2H (ANI007)

Table 4.12-4 Power CN (J4) (Stacking Connection to EXP Board)

Pin No.	V2HEVK Connection Destination	Pin No.	V2HEVK Connection Destination
1	+5.0 V	2	+5.0 V
3	+5.0 V	4	+5.0 V
5	+5.0 V	6	+5.0 V
7	+5.0 V	8	+5.0 V
9	GND	10	GND
11	GND	12	GND
13	GND	14	GND
15	GND	16	GND

4.13 Heat-sink Fan Connector

The V2HEVK has a heat-sink. When using a heat-sink, connect the power supply of the fan to CN14.

Table 4.13-1 Heat-sink Fan Connector (CN14)

Pin No.	Connection
1	NC
2	+12 V
3	GND

4.14 USB-PD Connector (Power only)

The V2HEVK operates with power supplied from USB-PD (CN13). The USB-PD controller is connected to CN13 and supplies 20 V (maximum 5 A) from the USB-PD power supply.

4.15 HDMI Interface

The EXP board of the V2HEVK has an HDMI interface. The HDMI Type-A connector (CN4) is connected to the RZ/V2H MIPI DSI interface via the DSI-HDMI conversion IC.

4.16 Audio Interface

The EXP board of the V2HEVK has three audio connectors. Three audio 3.5 mm jacks (P1: AUX, P2: HP, P3: MIC) are connected to the RZ/V2H SSI interface via the audio codec IC.

4.17 Pmod Connector

The EXP board of the V2HEVK has four Pmod connectors. The specifications are listed below.

Table 4.17-1 Pmod Type 1A GPIO (CN1)

Pin No.	Pmod Pin Spec.	V2HEVK Connection Destination
1	IO1	RZ/V2H (P80) via level shifter U4
2	IO2	RZ/V2H (P81) via level shifter U4
3	IO3	RZ/V2H (P82) via level shifter U4
4	IO4	RZ/V2H (P83) via level shifter U4
5	GND	GND
6	VCC	+3.3 V (D3.3V)
7	IO5	RZ/V2H (P84) via level shifter U4
8	IO6	RZ/V2H (P85) via level shifter U4
9	IO7	RZ/V2H (P86) via level shifter U4
10	IO8	RZ/V2H (P87) via level shifter U4
11	GND	GND
12	VCC	+3.3 V (D3.3V)

Table 4.17-2 Pmod Type 2A SPI (CN2)

Pin No.	Pmod Pin Spec.	V2HEVK Connection Destination
1	SSLA	RZ/V2H (PA7) via level shifter U5
2	MOSI	RZ/V2H (PB4) via level shifter U5
3	MISO	RZ/V2H (PB3) via level shifter U5
4	SCK	RZ/V2H (PB5) via level shifter U5
5	GND	GND
6	VCC	+3.3 V (D3.3V)
7	IO1	RZ/V2H (P74) via level shifter U5
8	IO2	RZ/V2H (P75) via level shifter U5
9	IO3	RZ/V2H (PA6) via level shifter U5
10	IO4	RZ/V2H (PA4) via level shifter U5
11	GND	GND
12	VCC	+3.3 V (D3.3V)

Table 4.17-3 Pmod Type 3A UART (CN3)

Pin No.	Pmod Pin Spec.	V2HEVK Connection Destination
1	CTS	RZ/V2H (P52) via level shifter U6
2	TXD	RZ/V2H (P50) via level shifter U6
3	RXD	RZ/V2H (P51) via level shifter U6
4	RTS	RZ/V2H (P53) via level shifter U6
5	GND	GND
6	VCC	+3.3 V (D3.3V)
7	IO1	RZ/V2H (P57) via level shifter U6
8	IO2	RZ/V2H (P73) via level shifter U6
9	IO3	RZ/V2H (P76) via level shifter U6
10	IO4	RZ/V2H (P77) via level shifter U6
11	GND	GND
12	VCC	+3.3 V (D3.3V)

Table 4.17-4 Pmod Type 6A I2C (CN6)

Pin No.	Pmod Pin Spec.	V2HEVK Connection Destination
1	IO1	RZ/V2H (P55) via level shifter U7
2	IO2	RZ/V2H (P54) via level shifter U7
3	SCL	RZ/V2H (P21) via level shifter U7
4	SDA	RZ/V2H (P20) via level shifter U7
5	GND	GND
6	VCC	+3.3 V (D3.3V)
7	IO3	RZ/V2H (P70) via level shifter U7
8	IO4	RZ/V2H (P72) via level shifter U7
9	IO5	RZ/V2H (P90) via level shifter U7
10	IO6	RZ/V2H (P91) via level shifter U7
11	GND	GND
12	VCC	+3.3 V (D3.3V)

5. Supplementary Note

5.1 Power Supply ICs of V2HEVK

In consideration of the evaluation usage, the power supply ICs of the V2HEVK are selected with a margin. The power supply ICs that suit the user circuit are recommended. For inquiries about power supply ICs, contact a Renesas Electronics sales representative.

5.2 Assembly of Heat-sink

- Remove the protective seal on the back of the heat-sink.
- Connect the heat-sink to the RZ/V2H Secure Evaluation Board.

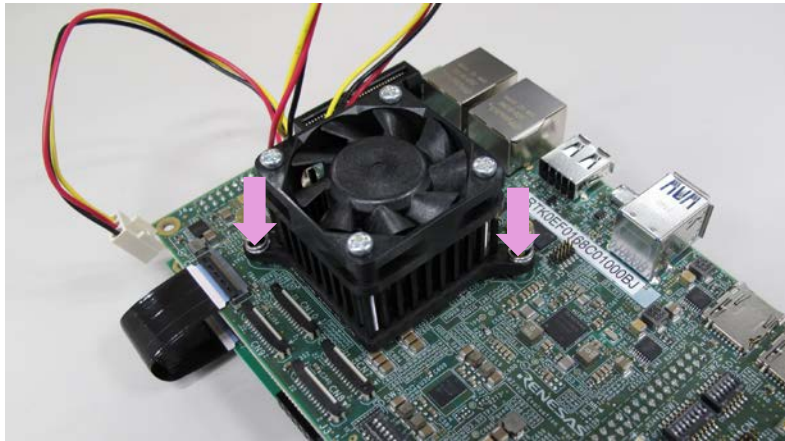

Figure 5.2-1 Connecting Heat-sink to RZ/V2H Secure Evaluation Board

- Connect the power supply of the heat-sink fan.

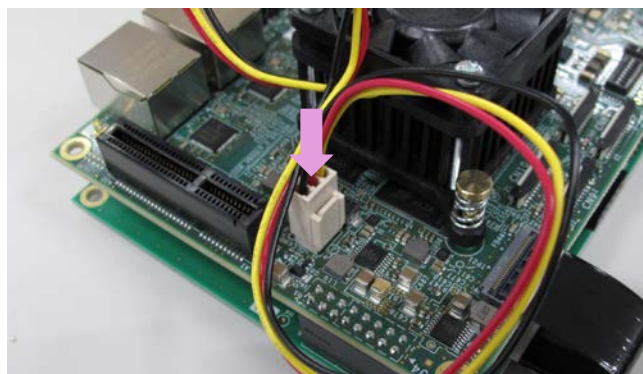
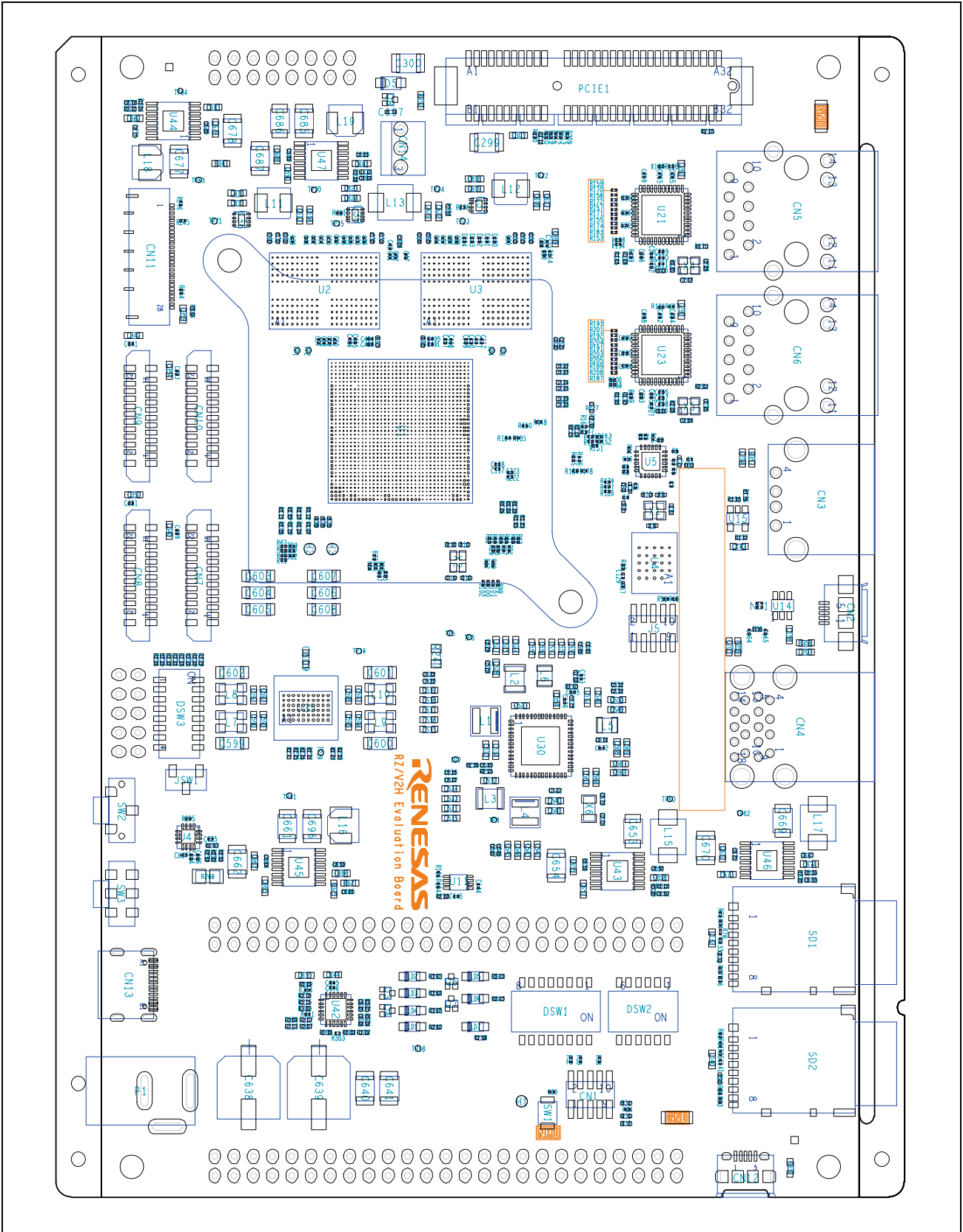
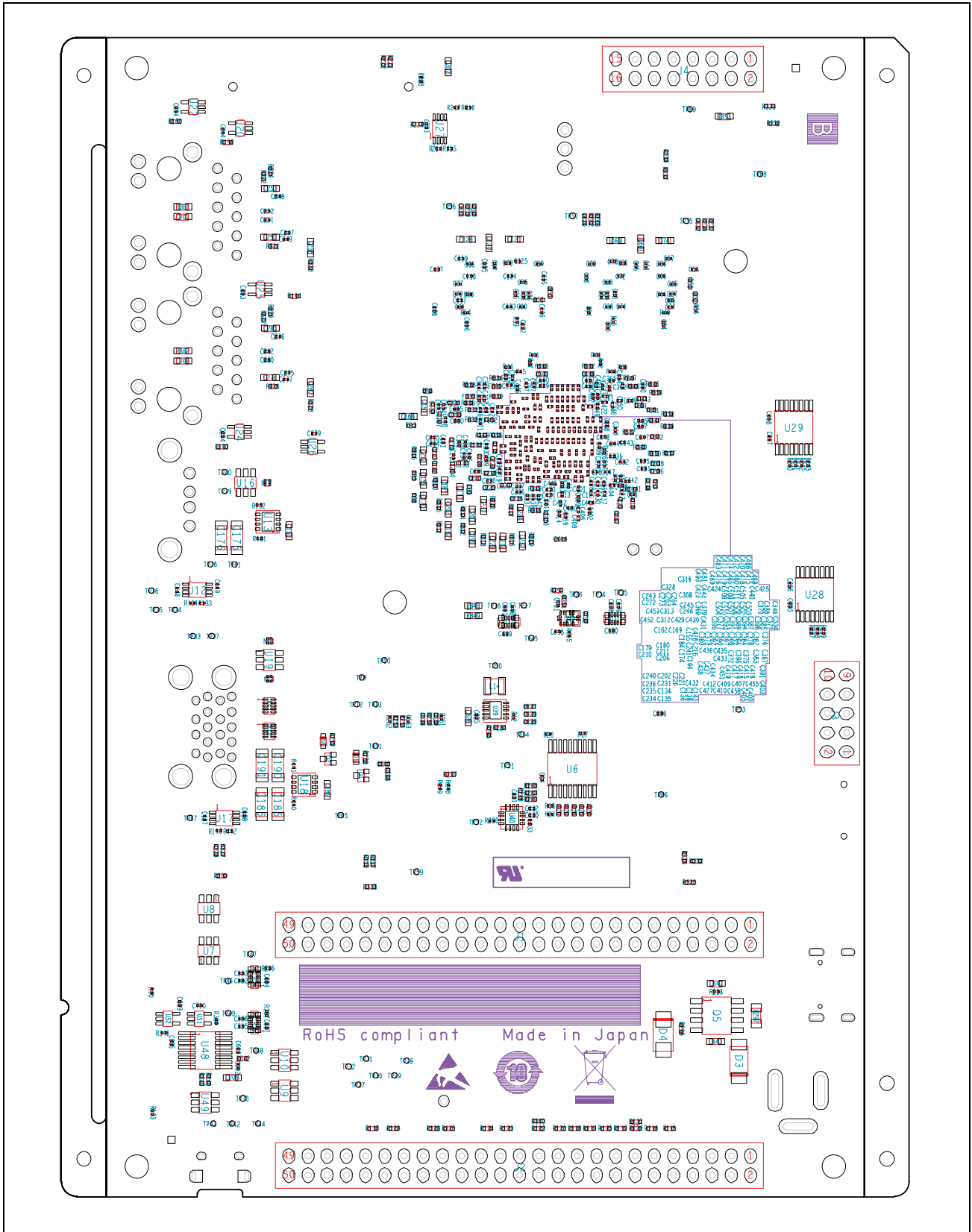

Figure 5.2-2 Connecting Power Supply of Heat-sink Fan

Appendix A CPU Board Parts Layout



Appendix A.1 Parts Layout (Top)



Appendix A.2 Parts Layout (Bottom)

REVISION HISTORY	RZ/V2H Evaluation Board Kit (Secure type) Hardware Manual
------------------	---

Rev.	Date	Description	
		Page	Summary
1.00	Dec 14, 2023	—	First edition issued
1.01	Mar 1, 2024	22	Table 3.2-1 "RAA215300" Part Name, modified.
1.02	Apr 10, 2024	14	1.3.2 V2HEVK Power Supply Specifications, added
		15	1.4.1 V2HEVK Power ON/OFF Note 1, added
		19	Figure 3.1-1 LD1 to LD7, added
1.03	Jun 25, 2024	17	Table 2.2-1 MD_CLKS function, modified
		28	Table 4.12-3 Title "Do not fit", added
1.04	Aug 20, 2024	11	Figure 1.2-1 LPDDR4X part name, modified
		13	Table 1.3-1 LPDDR4X part name, modified
1.05	Nov 22, 2024	1. Overview	
		11	Figure 1.2-1 RZ/V2H Secure Evaluation Board Block Diagram, modified ("Load switch" connected to VDD1833_SD0 and VDD1833_SD1, deleted)
		15	1.4.1 Turning V2HEVK Power On/Off: The title, modified
		2. Operating Procedure	
		17	2.2 Mode Setting: The title, modified
		17	Table 2.2-2 DSW2 Functions The function of Switch No. 5, modified
		17	Table 2.2-3 JSW1 Functions Note, added
		18	Table 2.2-4 DSW3 Functions Note, added
		18	Table 2.3-1 SW2/SW3 Functions The function of SW2, modified
		4. Interface Specifications	
		22	Table 4.3-1 RZ/V2H Secure Evaluation Board Switches The usage of SW2 and SW3, modified
		28	4.13 Heat-sink Fan Connector: The title, modified
		29	Table 4.17-3 Pmod Type 3A UART (CN3) The V2HEVK connection destination for pins, No. 1 to 4, modified: PA7 → P52, PB4 → P50, PB3 → P51, and PB5 → P53
Appendix A CPU Board Parts Layout			
31, 32	Appendix A CPU Board Parts Layout, added		
1.10	Mar 31, 2025	1. Overview	
		11	Figure 1.2-1 RZ/V2H Secure Evaluation Board Block Diagram (ISL97701IRZ, deleted. DDR0_VAA and DDR1_VAA, added.)
		15 to 17	1.3.5 List of Pin Functions, added
		3. Layout	
24	Table 3.2-1 RZ/V2H Secure Evaluation Board Parts List Part Symbol: U39, deleted		

RZ/V2H Evaluation Board Kit (Secure type)
Hardware Manual

Publication Date: Rev.1.00 Dec 14, 2023
 Rev.1.10 Mar 31, 2025

Published by: Renesas Electronics Corporation

RZ/V2H Evaluation Board Kit (Secure type)



Renesas Electronics Corporation

R12UZ0147EJ0110