

## Introduction

The evaluation board is designed to help the customer evaluate the 9ZXL1951D. The device is programmable through an SMBus interface. This user guide details the board set and connection, as well as the companion GUI installation for communicating to the device. The board has a self-contained USB to SMBus interface.

## Board Overview

Use [Figure 1](#) and [Table 1](#) to identify: USB connector, input and output frequency SMA connectors.

Figure 1. Evaluation Board Overview

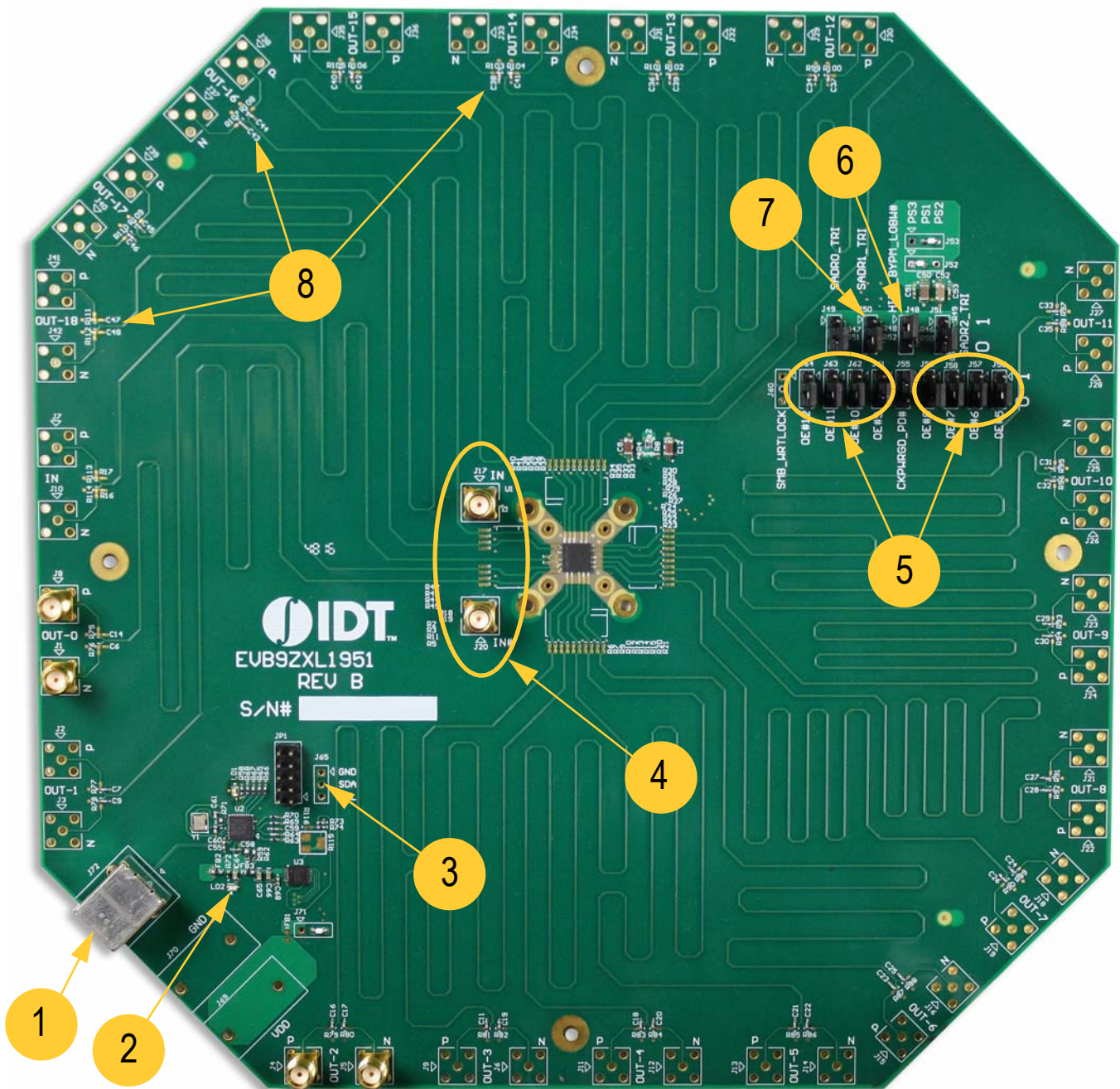

Table 1. Evaluation Board Pins and Functions

Label Number	Name	On-board Connector Label	Function																														
1	USB Interface	J72	Used for power-up of the device and connection with a PC, and for interaction with the IDT PCIe GUI. On-board USB to SMBus connection.																														
2	Power LED	LD2	Power from USB connector.																														
3	SMBus Header	J1	External SMBus connection.																														
4	Input Clock	J20, J17	Input clock SMA connector.																														
5	Jumper Setting	J64, J63, J62, J61 J59, J58, J57, J56	Output Enable for: OUT12, OUT11, OUT10, OUT9, OUT8, OUT7, OUT6, OUT5.																														
6	PLL Operation	J48	<ul style="list-style-type: none"> <li>▪ PLL High Bandwidth mode: Connect J48 pin 1 and pin 2.</li> <li>▪ PLL Bypass mode: Remove jumper in J48.</li> <li>▪ PLL Low Bandwidth mode: Connect J48 pin 2 and pin 3.</li> </ul> Note: Jumper J48 setting needs to power-cycle the board to take effect.																														
7	Address Select	J49, J50	<table border="1" style="width: 100%; border-collapse: collapse;"> <thead> <tr> <th>SMB_A1</th> <th>SMB_A0</th> <th>SMB_Addr</th> </tr> </thead> <tbody> <tr><td>0</td><td>0</td><td>0xD8</td></tr> <tr><td>0</td><td>M</td><td>0xDA</td></tr> <tr><td>0</td><td>1</td><td>0xDE</td></tr> <tr><td>M</td><td>0</td><td>0xC2</td></tr> <tr><td>M</td><td>M</td><td>0xC4</td></tr> <tr><td>M</td><td>1</td><td>0xC6</td></tr> <tr><td>1</td><td>0</td><td>0xCA</td></tr> <tr><td>1</td><td>M</td><td>0xCC</td></tr> <tr><td>1</td><td>1</td><td>0xCE</td></tr> </tbody> </table>	SMB_A1	SMB_A0	SMB_Addr	0	0	0xD8	0	M	0xDA	0	1	0xDE	M	0	0xC2	M	M	0xC4	M	1	0xC6	1	0	0xCA	1	M	0xCC	1	1	0xCE
SMB_A1	SMB_A0	SMB_Addr																															
0	0	0xD8																															
0	M	0xDA																															
0	1	0xDE																															
M	0	0xC2																															
M	M	0xC4																															
M	1	0xC6																															
1	0	0xCA																															
1	M	0xCC																															
1	1	0xCE																															
8	Output Ports	J1 to J42	HCSL clock output.																														

## Board Power Supply

By default, the board is set to be used with the USB power supply.

### USB Power Supply

When the board is connected to a PC through a USB cable, the on-board voltage regulators will generate 3.3V for the device.

## Connecting the Board

The board is connected to a PC through a USB connector for configuring and programming the device. The USB interface also provides a +5V power supply to the board, from which on-board voltage regulators generate various voltages for the core as well as for each output. The LD2 power LED will light up to indicate a successful connection.

## PCIe GUI Installation Setup

Download the [PCIe GUI software](#). The drivers should automatically install. If they do not, follow the instructions below.

First, the GUI requires a driver for the FTDI IC to interface between the USB and SMBus interfaces.

1. Unzip the files from the PCIe GUI archive on your PC.
2. Extract the FTDI windows driver from the PCIe GUI archive or go to the [FTDI website](#) to download the latest driver and install on your computer (see [Figure 2](#)).

**Note:** For non-Windows operating systems, download the respective driver from the FTDI website.

Figure 2. FTDI Currently Supported D2XX Drivers

Currently Supported D2XX Drivers:

Operating System	Release Date	Processor Architecture							Comments
		x86 (32-bit)	x64 (64-bit)	PPC	ARM	MIPSII	MIPSIV	SH4	
Windows*	2014-09-29	Available as <a href="#">setup executable</a> Contact <a href="mailto:support1@ftdichip.com">support1@ftdichip.com</a> if looking to create customised drivers			-	-	-	-	2.12.00 WHQL Certified Available as <a href="#">setup executable</a> <a href="#">Release Notes</a>
Windows RT	2014-07-04	<a href="#">1.0.2</a>	-	-	<a href="#">1.0.2</a>	-	-	-	A guide to support the driver (AN_271) is available <a href="#">here</a>
Linux	2012-06-29	1.1.12	1.1.12	-	1.1.12 Suitable for Raspberry Pi	-	-	-	<a href="#">ReadMe</a>
Mac OS X	2012-10-30	1.2.2	1.2.2	1.2.2	-	-	-	-	Requires Mac OS X 10.4 (Tiger) or later <a href="#">ReadMe</a>
Windows CE 4.2-5.2**	2014-22-04	1.0.1.10	-	-	1.0.1.10	1.0.1.6	1.0.1.6	1.0.1.6	
Windows CE 6.0/7.0	2014-22-04	1.0.1.10 CE 6.0 CAT CE 7.0 CAT	-	-	1.0.1.10 CE 6.0 CAT CE 7.0 CAT	1.0.1.6	1.0.1.6	1.0.1.6	For use of the CAT files supplied for ARM and x86 builds refer to <a href="#">AN_319</a>

3. Double click the executable file to install the driver (see [Figure 3](#)).

Figure 3. FTDI CDM Drivers Executable File Window

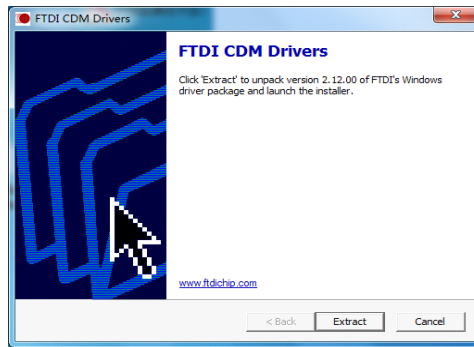

4. Connect the 9ZXL1951D board to the computer using the supplied USB cable. Double-click on the application file *ClockCtl.exe* to start the PCIe GUI support application. The PCIe Clock/Buffer GUI main window appears (see [Figure 4](#)). If no board is connected, the following message will appear:

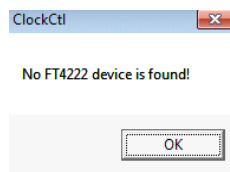

Figure 4. PCIe Clock/Buffer GUI Main Window

See Table 2 for descriptions.

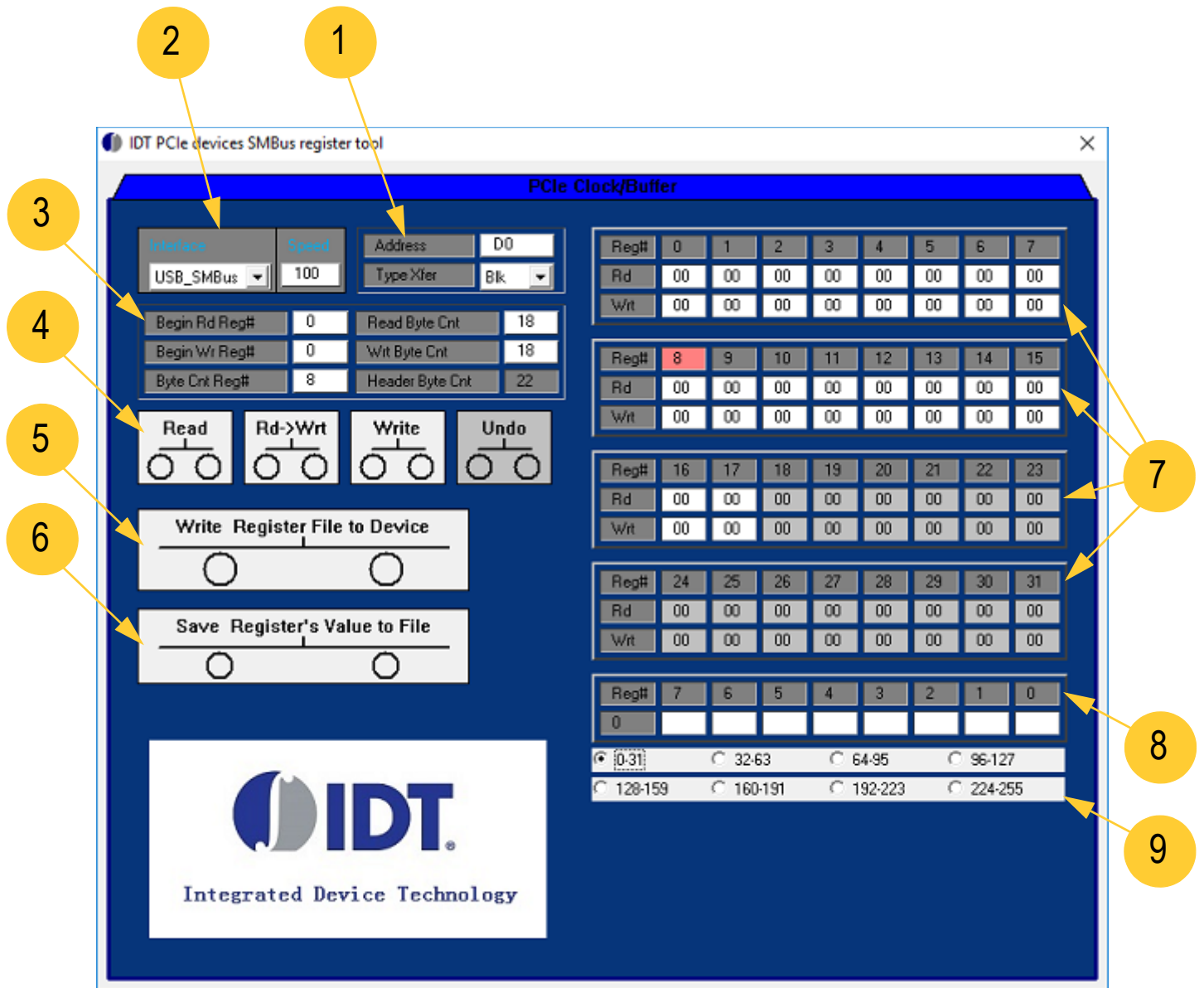

Table 2. PCIe Clock/Buffer GUI Main Window Label Descriptions



Label #	Name	Description
1	Slave Address/TypeXfer	<p>The address is 7-bit slave address combined with "0" in LSB. For example, if the slave address is 1101000, "D0" should be filled.</p>  <p>There are three modes for transfer type: "Blk", "Byte" and "Word". The device is SMBus block (Blk) mode protocol by default.</p> 
2	SMBus Interface	<p>Only USB to SMBus is available. The SMBus speed (in kHz) can be changed. Note that the speed of SMBus is from 10kHz to 100kHz.</p> 
3	Begin Reg# and Byte Count	<ul style="list-style-type: none"> <li>▪ <i>Begin Rd Reg#</i> is the begin register address of a read operation.</li> <li>▪ <i>Read Byte Cnt</i> is the byte count of a read operation.</li> <li>▪ <i>Begin Wr Reg#</i> is the begin register address of a write operation.</li> <li>▪ <i>Wrt Byte Cnt</i> is the byte count of a write operation.</li> </ul> 

Table 2. PCIe Clock/Buffer GUI Main Window Label Descriptions (Cont.)



Label #	Name	Description
4	Register Operations	<ul style="list-style-type: none"> <li data-bbox="461 279 1526 422"> <p>▪ <i>Read</i> operation</p> <p>Clicking the <i>Read</i> button initiates a read. If a chipset is used for reading, the byte count is determined by the value in the device byte count register. The byte count cannot be larger than 32 dec. Non-read locations in the read grid will be grayed out.</p> <div data-bbox="472 436 651 562" style="border: 1px solid black; padding: 5px; text-align: center;"> <p>Read</p>  </div> </li> <li data-bbox="461 583 1526 659"> <p>▪ <i>Rd-&gt;Wrt</i> operation</p> <p>Clicking the <i>Rd-&gt;Wrt</i> button copies all of the read cells to the write cell contents.</p> <div data-bbox="472 674 643 800" style="border: 1px solid black; padding: 5px; text-align: center;"> <p>Rd-&gt;Wrt</p>  </div> </li> <li data-bbox="461 814 1526 999"> <p>▪ <i>Write</i> operation</p> <p><i>Write</i> button operation. If the chipset is used for writing, the byte count is controlled by the value in the GUI panel byte count register. Registers that will not be written because of the starting location setting and byte count will be grayed out.</p> <p>The hex values for data to be written will be in a cell with a white background.</p> <div data-bbox="472 1014 626 1140" style="border: 1px solid black; padding: 5px; text-align: center;"> <p>Write</p>  </div> </li> <li data-bbox="461 1157 1526 1232"> <p>▪ <i>Undo</i> operation</p> <p>Reverts back to the last performed operation.</p> <div data-bbox="472 1247 639 1373" style="border: 1px solid black; padding: 5px; text-align: center;"> <p>Undo</p>  </div> </li> </ul>

Table 2. PCIe Clock/Buffer GUI Main Window Label Descriptions (Cont.)

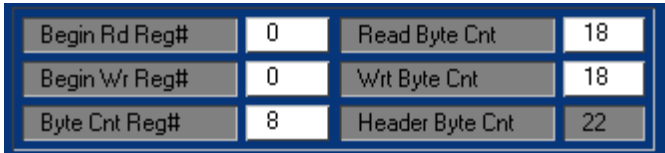
Label #	Name	Description
5	Write Register File to Device	<p>Clicking the “Write Register File to Device” button writes the register from file. A pop-up window appears allowing the selection of the file path and the file name. Once selected, click “Open”. The GUI will read all the register’s value from the file and then download to the device.</p>  

Table 2. PCIe Clock/Buffer GUI Main Window Label Descriptions (Cont.)

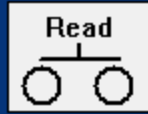
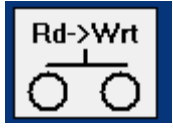
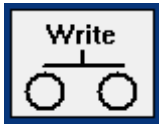

Label #	Name	Description
6	Save Register's Value to File	<p>Clicking the “Save Registers Value to File” button saves the registers to the file, A pop-up window is displayed. Select the file path and enter a file name, then click “Save”. The GUI will dump all the register's value then save to the file.</p> 
7	Register Value Field	<p>The hexadecimal <i>read</i> information appears as a grayed background, meaning that it cannot be altered. Hexadecimal <i>write</i> information appears on a white background.</p> 
8	Binary Display Table	<p>Clicking on a <i>Reg#</i> or <i>Rd</i> window displays the binary decode of the hex value. This may be used for entering binary data instead of hexadecimal data.</p> 

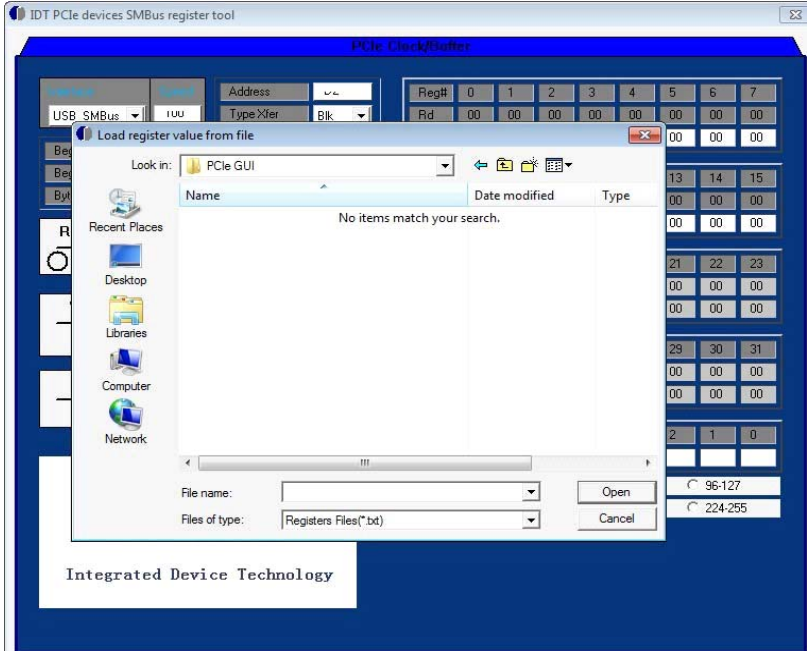

Table 2. PCIe Clock/Buffer GUI Main Window Label Descriptions (Cont.)

Label #	Name	Description
9	Byte Count Range Switch	<p>A 32-byte value is the default display. If the byte count exceeds 32, select the radio button that coincides with the new range.</p> 

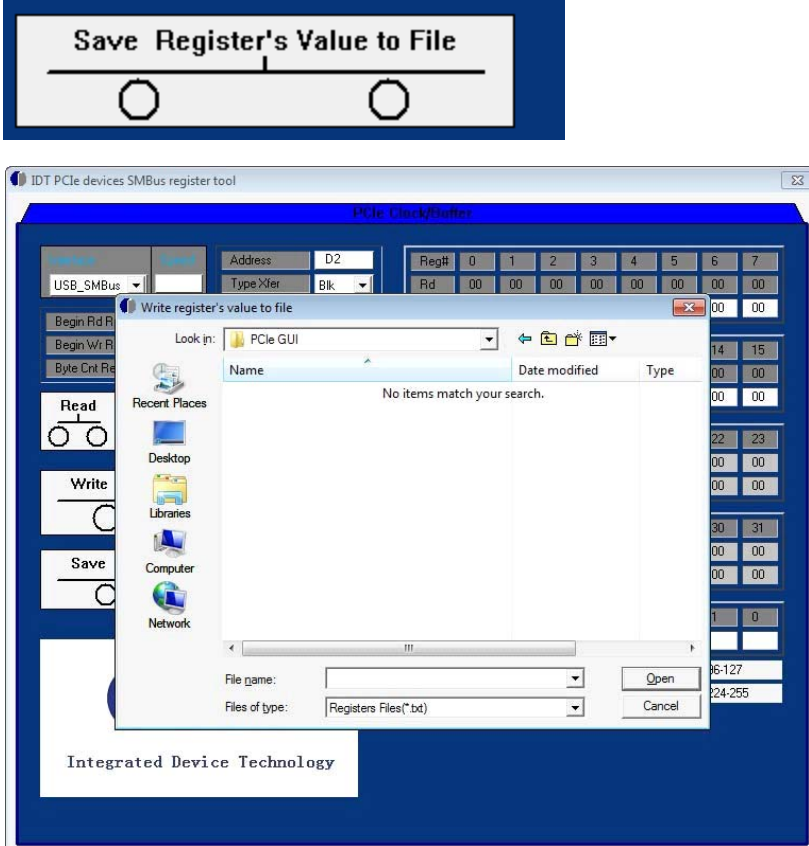
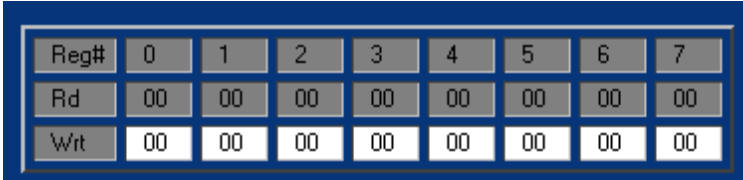
## Read/Write Operations

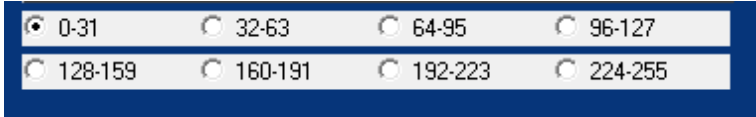
### Read

Pressing the read button initiates a read. If a chip set is used for reading, the byte count is determined by the value in the device byte count register. The byte count cannot be larger than 32 dec. Non-read locations in the read grid will be grayed out.

### Rd->Wrt

Pressing the Rd->Wrt button will copies all of the read cells to the write cell contents.

### Write

Write button operation. If the chip set is used for writing, the byte count is controlled by the value in the GUI panel byte count register. Registers that will not be written because of the starting location setting and byte count will be grayed out.

The hex values for data to be written will be in a cell with a white background.

## Read/Write from File

To Write register from file, click the “Write Register File to Device” button. A pop-up window is displayed (see [Figure 5](#)). Select the file path and enter a file name, then click “Open”. The GUI will read all register’s value from the file, then download to the device.

Figure 5. Load Register Value from File Pop-up Window

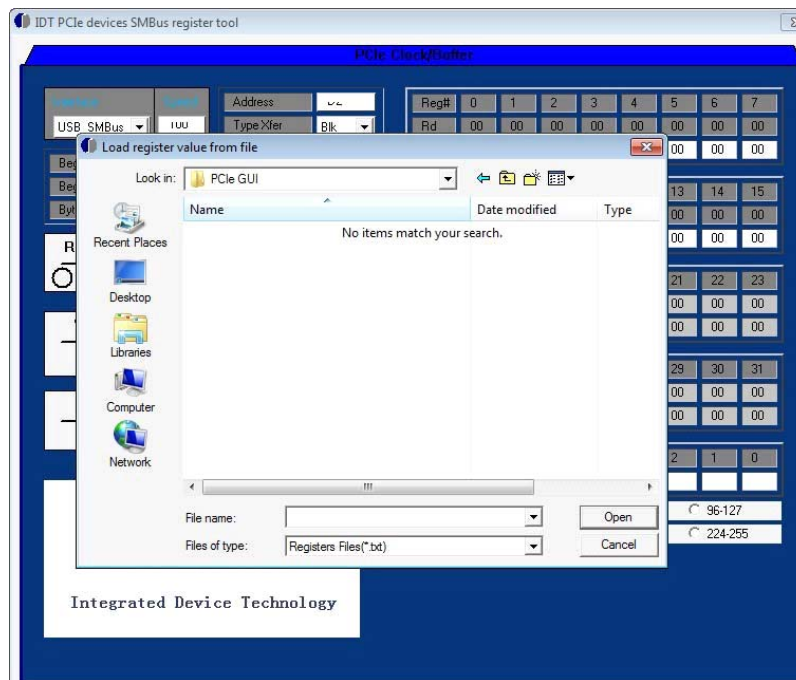

Clicking the “Save Registers Value to File” button saves the registers to a file. A pop-up window is displayed (see Figure 6). Select the file path and enter a file name, then click “Save”. The GUI will dump all register’s value then save to the file.

Note: LED LD1 will light up on every SDATA operation.

Figure 6. Write Register Value from File Pop-up Window

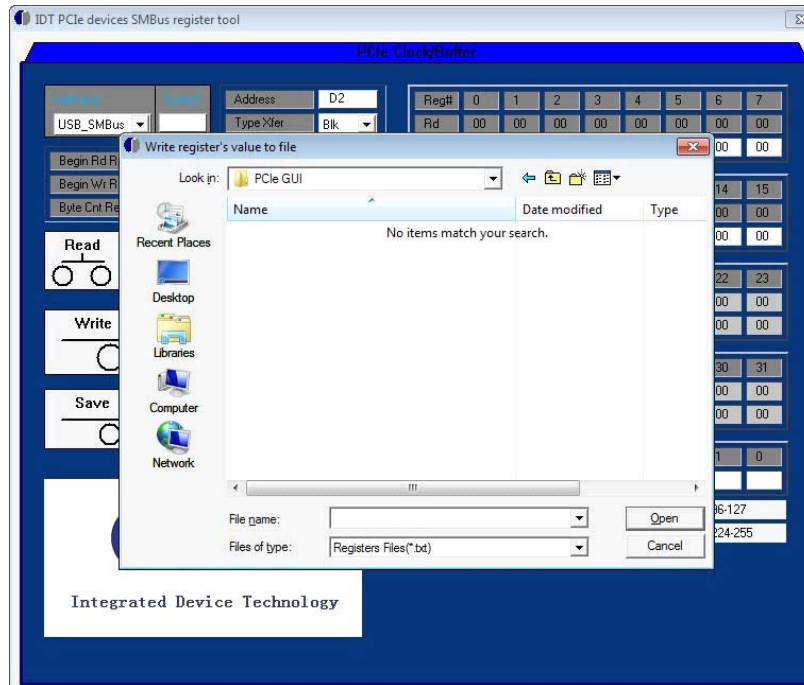

# Schematics

Figure 7. 9ZXL1951D Connections

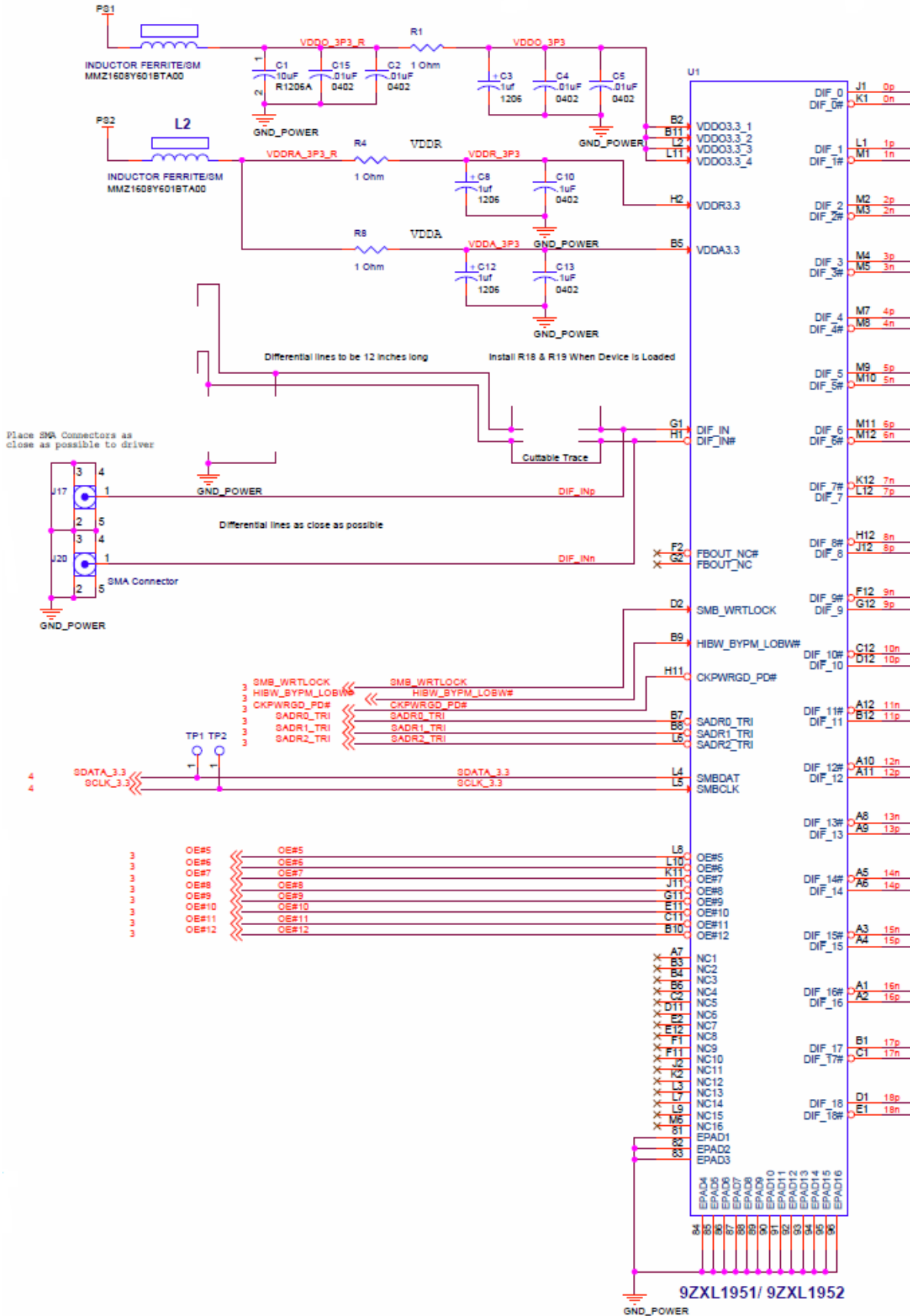
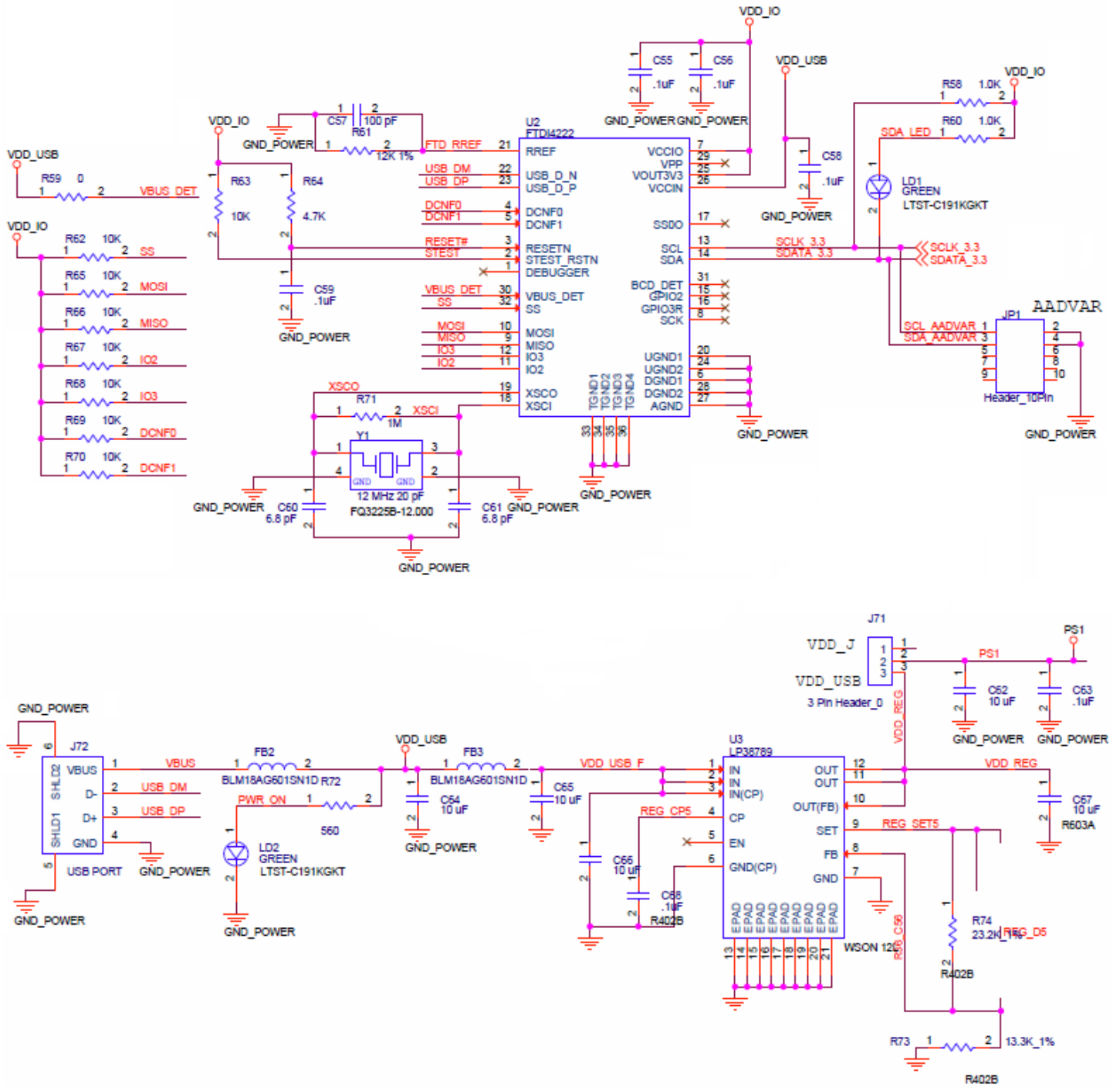

Figure 8. USB Interface and Power



## Ordering Information

Orderable Part Number	Description
EVK9ZXL1951D	9ZXL1951D Evaluation Kit

## Revision History

Revision Date	Description of Change
March 23, 2018	Initial release.

## IMPORTANT NOTICE AND DISCLAIMER

RENESAS ELECTRONICS CORPORATION AND ITS SUBSIDIARIES (“RENESAS”) PROVIDES TECHNICAL SPECIFICATIONS AND RELIABILITY DATA (INCLUDING DATASHEETS), DESIGN RESOURCES (INCLUDING REFERENCE DESIGNS), APPLICATION OR OTHER DESIGN ADVICE, WEB TOOLS, SAFETY INFORMATION, AND OTHER RESOURCES “AS IS” AND WITH ALL FAULTS, AND DISCLAIMS ALL WARRANTIES, EXPRESS OR IMPLIED, INCLUDING, WITHOUT LIMITATION, ANY IMPLIED WARRANTIES OF MERCHANTABILITY, FITNESS FOR A PARTICULAR PURPOSE, OR NON-INFRINGEMENT OF THIRD-PARTY INTELLECTUAL PROPERTY RIGHTS.

These resources are intended for developers who are designing with Renesas products. You are solely responsible for (1) selecting the appropriate products for your application, (2) designing, validating, and testing your application, and (3) ensuring your application meets applicable standards, and any other safety, security, or other requirements. These resources are subject to change without notice. Renesas grants you permission to use these resources only to develop an application that uses Renesas products. Other reproduction or use of these resources is strictly prohibited. No license is granted to any other Renesas intellectual property or to any third-party intellectual property. Renesas disclaims responsibility for, and you will fully indemnify Renesas and its representatives against, any claims, damages, costs, losses, or liabilities arising from your use of these resources. Renesas' products are provided only subject to Renesas' Terms and Conditions of Sale or other applicable terms agreed to in writing. No use of any Renesas resources expands or otherwise alters any applicable warranties or warranty disclaimers for these products.

(Disclaimer Rev.1.01 Jan 2024)

### Corporate Headquarters

TOYOSU FORESIA, 3-2-24 Toyosu,  
Koto-ku, Tokyo 135-0061, Japan  
[www.renesas.com](http://www.renesas.com)

### Trademarks

Renesas and the Renesas logo are trademarks of Renesas Electronics Corporation. All trademarks and registered trademarks are the property of their respective owners.

### Contact Information

For further information on a product, technology, the most up-to-date version of a document, or your nearest sales office, please visit [www.renesas.com/contact-us/](http://www.renesas.com/contact-us/).