

To our customers,

---

## Old Company Name in Catalogs and Other Documents

---

On April 1<sup>st</sup>, 2010, NEC Electronics Corporation merged with Renesas Technology Corporation, and Renesas Electronics Corporation took over all the business of both companies. Therefore, although the old company name remains in this document, it is a valid Renesas Electronics document. We appreciate your understanding.

Renesas Electronics website: <http://www.renesas.com>

April 1<sup>st</sup>, 2010  
Renesas Electronics Corporation

Issued by: Renesas Electronics Corporation (<http://www.renesas.com>)

Send any inquiries to <http://www.renesas.com/inquiry>.

## Notice

1. All information included in this document is current as of the date this document is issued. Such information, however, is subject to change without any prior notice. Before purchasing or using any Renesas Electronics products listed herein, please confirm the latest product information with a Renesas Electronics sales office. Also, please pay regular and careful attention to additional and different information to be disclosed by Renesas Electronics such as that disclosed through our website.
2. Renesas Electronics does not assume any liability for infringement of patents, copyrights, or other intellectual property rights of third parties by or arising from the use of Renesas Electronics products or technical information described in this document. No license, express, implied or otherwise, is granted hereby under any patents, copyrights or other intellectual property rights of Renesas Electronics or others.
3. You should not alter, modify, copy, or otherwise misappropriate any Renesas Electronics product, whether in whole or in part.
4. Descriptions of circuits, software and other related information in this document are provided only to illustrate the operation of semiconductor products and application examples. You are fully responsible for the incorporation of these circuits, software, and information in the design of your equipment. Renesas Electronics assumes no responsibility for any losses incurred by you or third parties arising from the use of these circuits, software, or information.
5. When exporting the products or technology described in this document, you should comply with the applicable export control laws and regulations and follow the procedures required by such laws and regulations. You should not use Renesas Electronics products or the technology described in this document for any purpose relating to military applications or use by the military, including but not limited to the development of weapons of mass destruction. Renesas Electronics products and technology may not be used for or incorporated into any products or systems whose manufacture, use, or sale is prohibited under any applicable domestic or foreign laws or regulations.
6. Renesas Electronics has used reasonable care in preparing the information included in this document, but Renesas Electronics does not warrant that such information is error free. Renesas Electronics assumes no liability whatsoever for any damages incurred by you resulting from errors in or omissions from the information included herein.
7. Renesas Electronics products are classified according to the following three quality grades: “Standard”, “High Quality”, and “Specific”. The recommended applications for each Renesas Electronics product depends on the product’s quality grade, as indicated below. You must check the quality grade of each Renesas Electronics product before using it in a particular application. You may not use any Renesas Electronics product for any application categorized as “Specific” without the prior written consent of Renesas Electronics. Further, you may not use any Renesas Electronics product for any application for which it is not intended without the prior written consent of Renesas Electronics. Renesas Electronics shall not be in any way liable for any damages or losses incurred by you or third parties arising from the use of any Renesas Electronics product for an application categorized as “Specific” or for which the product is not intended where you have failed to obtain the prior written consent of Renesas Electronics. The quality grade of each Renesas Electronics product is “Standard” unless otherwise expressly specified in a Renesas Electronics data sheets or data books, etc.
  - “Standard”: Computers; office equipment; communications equipment; test and measurement equipment; audio and visual equipment; home electronic appliances; machine tools; personal electronic equipment; and industrial robots.
  - “High Quality”: Transportation equipment (automobiles, trains, ships, etc.); traffic control systems; anti-disaster systems; anti-crime systems; safety equipment; and medical equipment not specifically designed for life support.
  - “Specific”: Aircraft; aerospace equipment; submersible repeaters; nuclear reactor control systems; medical equipment or systems for life support (e.g. artificial life support devices or systems), surgical implantations, or healthcare intervention (e.g. excision, etc.), and any other applications or purposes that pose a direct threat to human life.
8. You should use the Renesas Electronics products described in this document within the range specified by Renesas Electronics, especially with respect to the maximum rating, operating supply voltage range, movement power voltage range, heat radiation characteristics, installation and other product characteristics. Renesas Electronics shall have no liability for malfunctions or damages arising out of the use of Renesas Electronics products beyond such specified ranges.
9. Although Renesas Electronics endeavors to improve the quality and reliability of its products, semiconductor products have specific characteristics such as the occurrence of failure at a certain rate and malfunctions under certain use conditions. Further, Renesas Electronics products are not subject to radiation resistance design. Please be sure to implement safety measures to guard them against the possibility of physical injury, and injury or damage caused by fire in the event of the failure of a Renesas Electronics product, such as safety design for hardware and software including but not limited to redundancy, fire control and malfunction prevention, appropriate treatment for aging degradation or any other appropriate measures. Because the evaluation of microcomputer software alone is very difficult, please evaluate the safety of the final products or system manufactured by you.
10. Please contact a Renesas Electronics sales office for details as to environmental matters such as the environmental compatibility of each Renesas Electronics product. Please use Renesas Electronics products in compliance with all applicable laws and regulations that regulate the inclusion or use of controlled substances, including without limitation, the EU RoHS Directive. Renesas Electronics assumes no liability for damages or losses occurring as a result of your noncompliance with applicable laws and regulations.
11. This document may not be reproduced or duplicated, in any form, in whole or in part, without prior written consent of Renesas Electronics.
12. Please contact a Renesas Electronics sales office if you have any questions regarding the information contained in this document or Renesas Electronics products, or if you have any other inquiries.

(Note 1) “Renesas Electronics” as used in this document means Renesas Electronics Corporation and also includes its majority-owned subsidiaries.

(Note 2) “Renesas Electronics product(s)” means any product developed or manufactured by or for Renesas Electronics.

# M16C R8C FoUSB/UART Debugger

User's Manual

Renesas Microcomputer Development  
Environment System

R8C Family R8C/2x Series

Notes on Connecting R8C/2G, R8C/2H, R8C/2J

Active X, Microsoft, MS-DOS, Visual Basic, Visual C++, Windows and Windows NT are either registered trademarks or trademarks of Microsoft Corporation in the United States and other countries.

IBM and AT are registered trademarks of International Business Machines Corporation.

Intel and Pentium are registered trademarks of Intel Corporation.

Adobe and Acrobat are registered trademarks of Adobe Systems Incorporated.

All other brand and product names are trademarks, registered trademarks or service marks of their respective holders.

#### **Keep safety first in your circuit designs!**

- Renesas Technology Corporation and Renesas Solutions Corporation put the maximum effort into making semiconductor products better and more reliable, but there is always the possibility that trouble may occur with them. Trouble with semiconductors may lead to personal injury, fire or property damage. Remember to give due consideration to safety when making your circuit designs, with appropriate measures such as (i) placement of substitutive, auxiliary circuits, (ii) use of nonflammable material or (iii) prevention against any malfunction or mishap.

#### **Notes regarding these materials**

- These materials are intended as a reference to assist our customers in the selection of the Renesas Technology product best suited to the customer's application; they do not convey any license under any intellectual property rights, or any other rights, belonging to Renesas Technology Corporation, Renesas Solutions Corporation or a third party.
- Renesas Technology Corporation and Renesas Solutions Corporation assume no responsibility for any damage, or infringement of any third-party's rights, originating in the use of any product data, diagrams, charts, programs, algorithms, or circuit application examples contained in these materials.
- All information contained in these materials, including product data, diagrams, charts, programs and algorithms, represents information on products at the time of publication of these materials, and are subject to change by Renesas Technology Corporation and Renesas Solutions Corporation without notice due to product improvements or other reasons. It is therefore recommended that customers contact Renesas Technology Corporation, Renesas Solutions Corporation or an authorized Renesas Technology product distributor for the latest product information before purchasing a product listed herein. The information described here may contain technical inaccuracies or typographical errors. Renesas Technology Corporation and Renesas Solutions Corporation assume no responsibility for any damage, liability, or other loss rising from these inaccuracies or errors. Please also pay attention to information published by Renesas Technology Corporation and Renesas Solutions Corporation by various means, including the Renesas home page (<http://www.renesas.com>).
- When using any or all of the information contained in these materials, including product data, diagrams, charts, programs, and algorithms, please be sure to evaluate all information as a total system before making a final decision on the applicability of the information and products. Renesas Technology Corporation and Renesas Solutions Corporation assume no responsibility for any damage, liability or other loss resulting from the information contained herein.
- Renesas Technology semiconductors are not designed or manufactured for use in a device or system that is used under circumstances in which human life is potentially at stake. Please contact Renesas Technology Corporation, Renesas Solutions Corporation or an authorized Renesas Technology product distributor when considering the use of a product contained herein for any specific purposes, such as apparatus or systems for transportation, vehicular, medical, aerospace, nuclear, or undersea repeater use.
- The prior written approval of Renesas Technology Corporation and Renesas Solutions Corporation is necessary to reprint or reproduce in whole or in part these materials.
- If these products or technologies are subject to the Japanese export control restrictions, they must be exported under a license from the Japanese government and cannot be imported into a country other than the approved destination. Any diversion or reexport contrary to the export control laws and regulations of Japan and/or the country of destination is prohibited.
- Please contact Renesas Technology Corporation or Renesas Solutions Corporation for further details on these materials or the products contained therein.

# Table of Contents

1. Connecting the Target Board to the User System.....	4
2. Preparing the M16C R8C FoUSB/UART Debugger .....	6
3. Memory Map When Using the R8C UART Debugger.....	20
4. Monitor Program Occupied Area.....	21
5. Notes on Using the R8C UART Debugger.....	21
5.1. Changing communication speed and restarting the R8C UART debugger after the R8C UART debugger is done .....	21
5.2. User program ID code.....	21
5.3. User program download area .....	22
5.4. Frequency characteristics .....	25
5.5. Limitations of SFR operations.....	26
5.6. Limitations on stop mode and wait mode .....	26
5.7. Watchdog timer .....	27
5.8. Real-time operation of user program .....	27
5.9. Executing anomalistic steps.....	28
5.10. Limitations on peripheral functions .....	29
5.11. Limitations on the flag register .....	29
5.12. Operation on peripheral I/O during a break .....	29

# 1. Connecting the Target Board to the User System

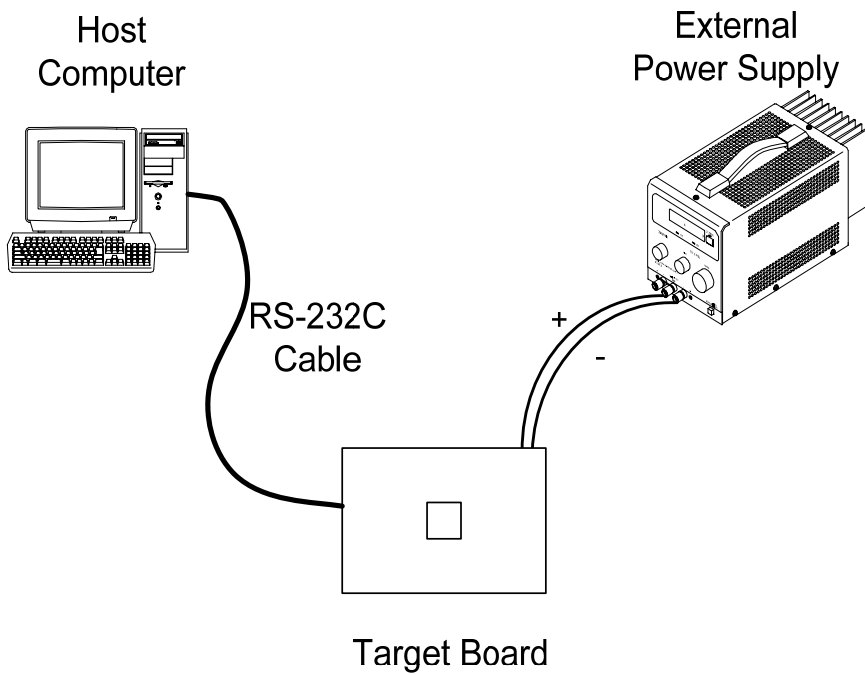

Figure 1 Connecting the Target Board to the User System

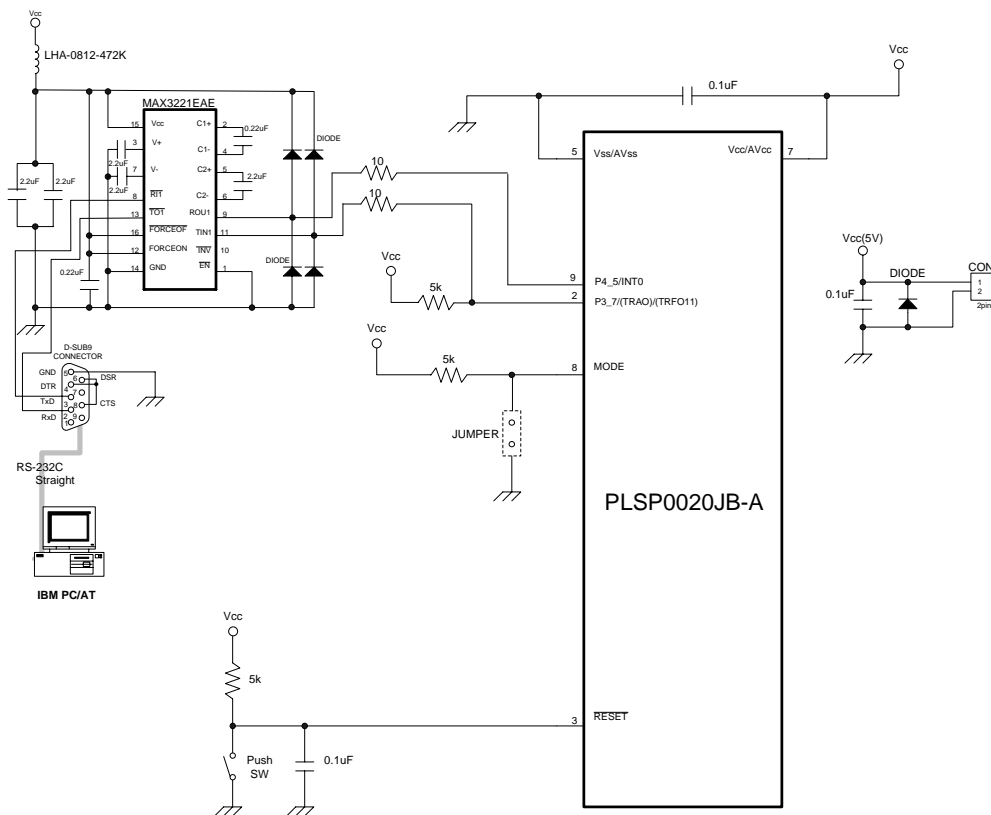

Figure 2 Circuit Using the RS-232C Cable (R8C/2H, 2J Groups)



## 2. Preparing the M16C R8C FoUSB/UART Debugger

The M16C R8C FoUSB/UART debugger (hereinafter R8C UART debugger) is used for debugging by connecting an RS-232 cable between the host computer and the target board.

A monitor program comes bundled and is automatically installed with the R8C UART debugger software.

For the R8C Family, the monitor program is automatically programmed when starting the R8C UART debugger. The monitor program does not need to be preprogrammed with an M16C FlashStarter or other flash programmer.

- a) To start the High-performance Embedded Workshop (HEW), go to “Start”, “Programs”, “Renesas”, “High-performance Embedded Workshop”, and “High-performance Embedded Workshop”. You will see the following “Welcome!” dialog box.

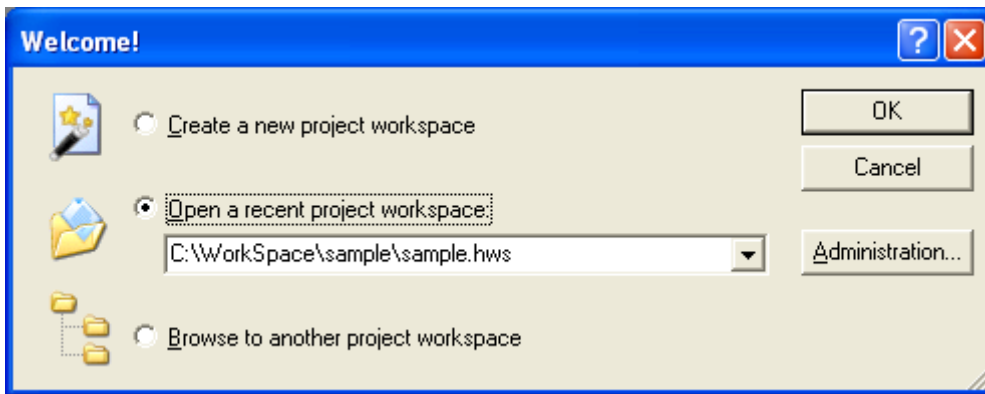

- [Create a new project work space]  
Select this when creating a new workspace.
- [Open a recent project workspace]  
Select this when using an existing workspace. Previous workspaces are displayed in the pull-down menu.
- [Browse to another project workspace]  
Select this when using an existing workspace, and there are no previous workspaces listed in the pull-down menu.

After selecting an existing workspace and pressing [OK], the screen under letter t) (Page 17) is displayed.



- b) Select “Create a new project workspace”. Press [OK].

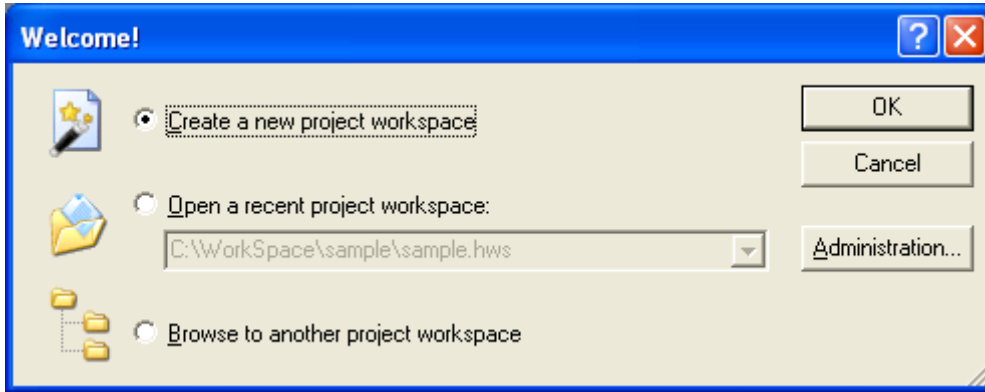

- c) The Project Generator starts. When a toolchain is preinstalled, the following screen is displayed.

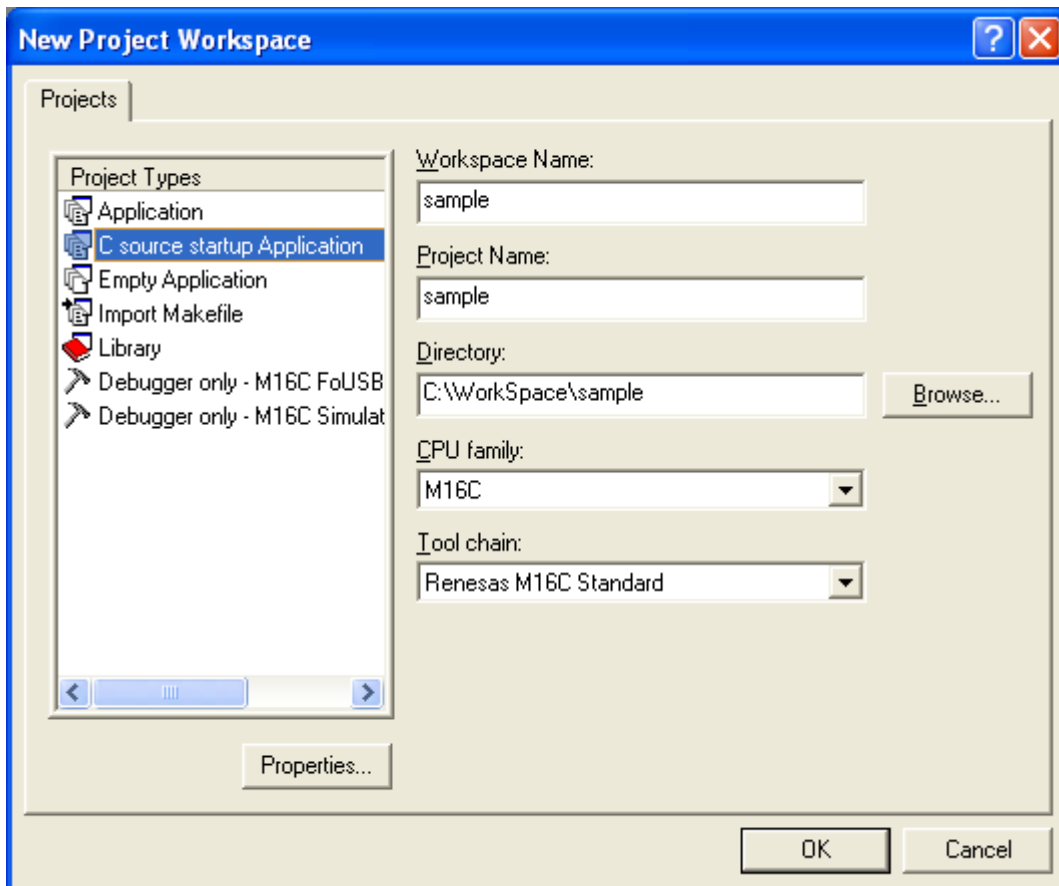

- [Workspace Name]  
Enter a name to create a new workspace. “sample” has been input as an example.
- [Project Name]  
Enter a project name. If the project name is to be the same as the workspace name, it is not necessary to input anything in the [Project Name] field.

- [CPU family]  
Select the applicable CPU family. In this case, M16C has been selected for the R8C Family.
- [Toolchain]  
When using a toolchain, select the applicable toolchain name. When not using a toolchain, select "None".
- [Project Types] Window  
Select a project type. The project type which supports the C start-up has been selected as an example.

d) Set the toolchain version.

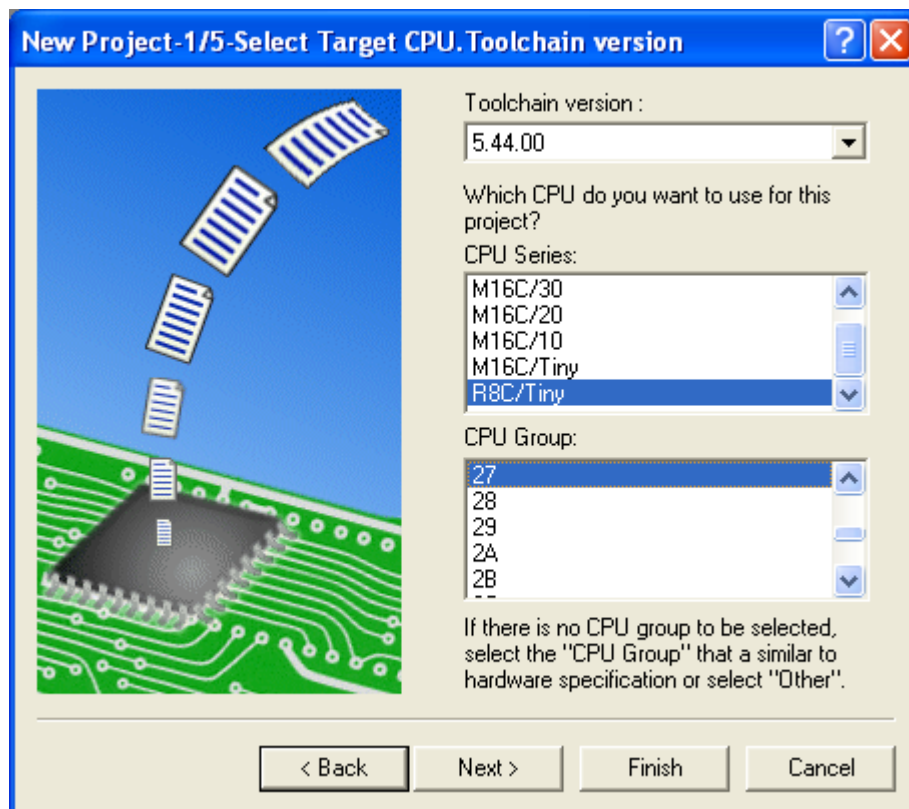

Select the "Toolchain Version", "CPU Series", "CPU Group" and then press [Next]. In this example, R8C/27 Group is selected.

e) Select the MCU ROM size and other related settings.

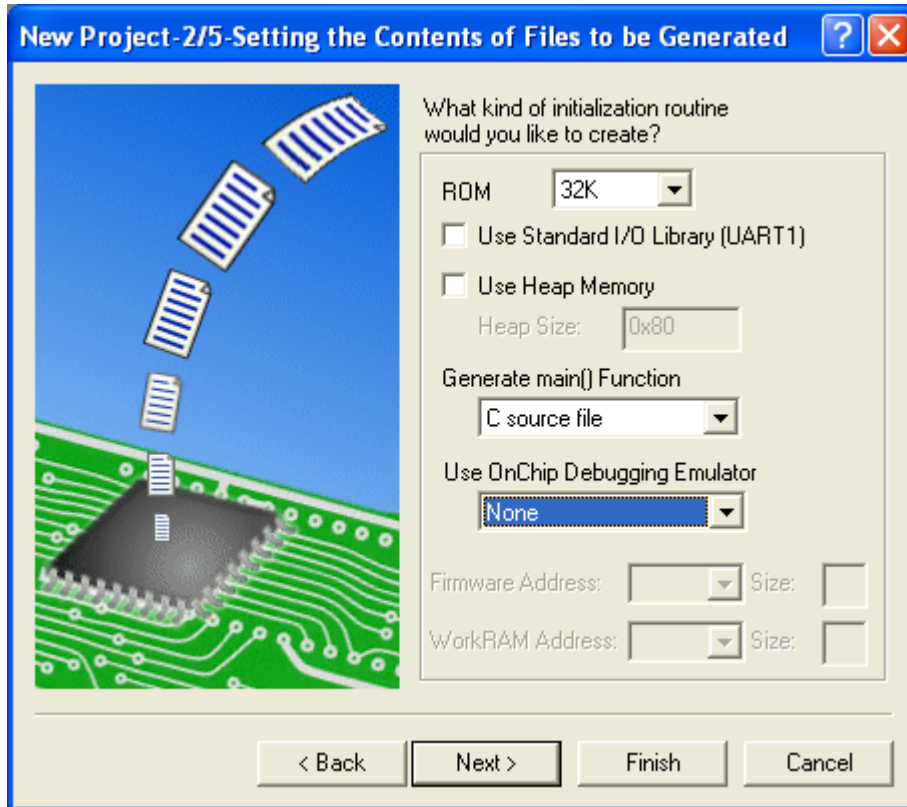

Select the MCU ROM size and heap size. Select “None” for the on-chip debugging emulator. And press [Next].

f) Set the stack.

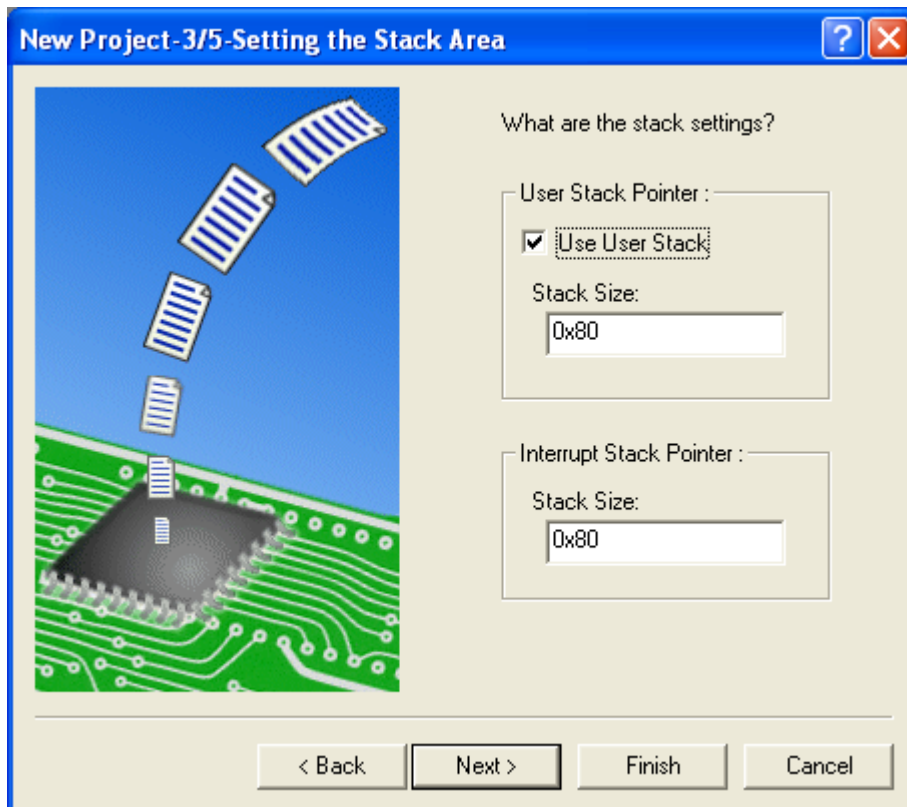

Set the “Stack Size” and press [Next].

g) When the toolchain setting is complete, the following screen is displayed.

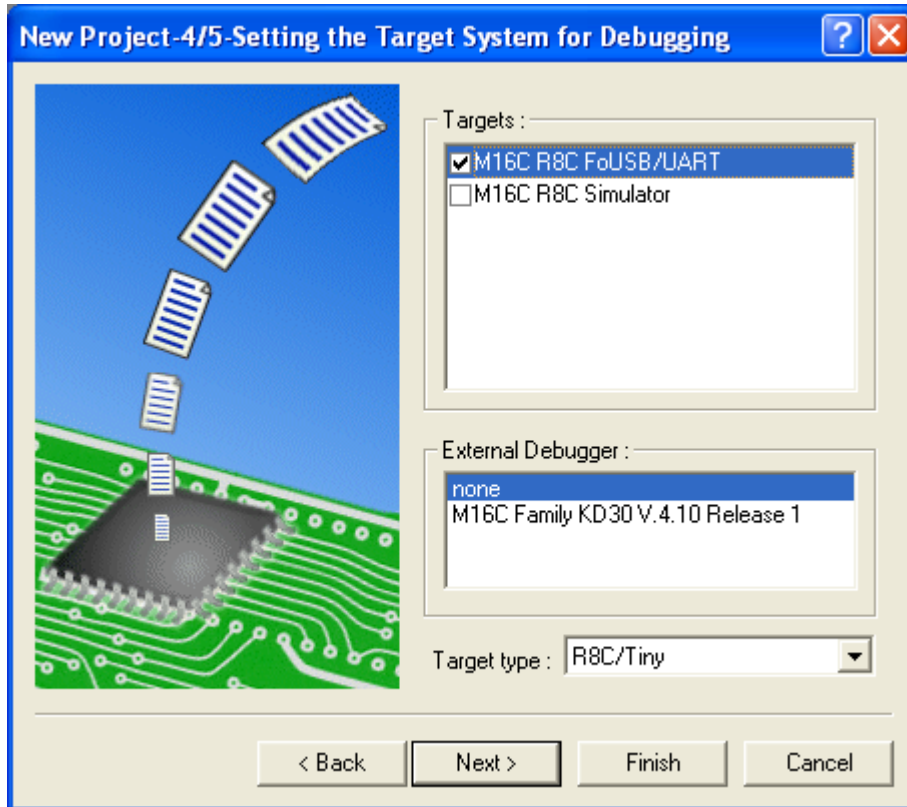

Select "M16C R8C FoUSB/UART" and press [Next].

If necessary, select other targets.

h) Set the configuration file name.

Configurations are the build option settings (e.g., output of debug information or optimization) having their own names. The term "configuration" can also be referred to as "build configuration".

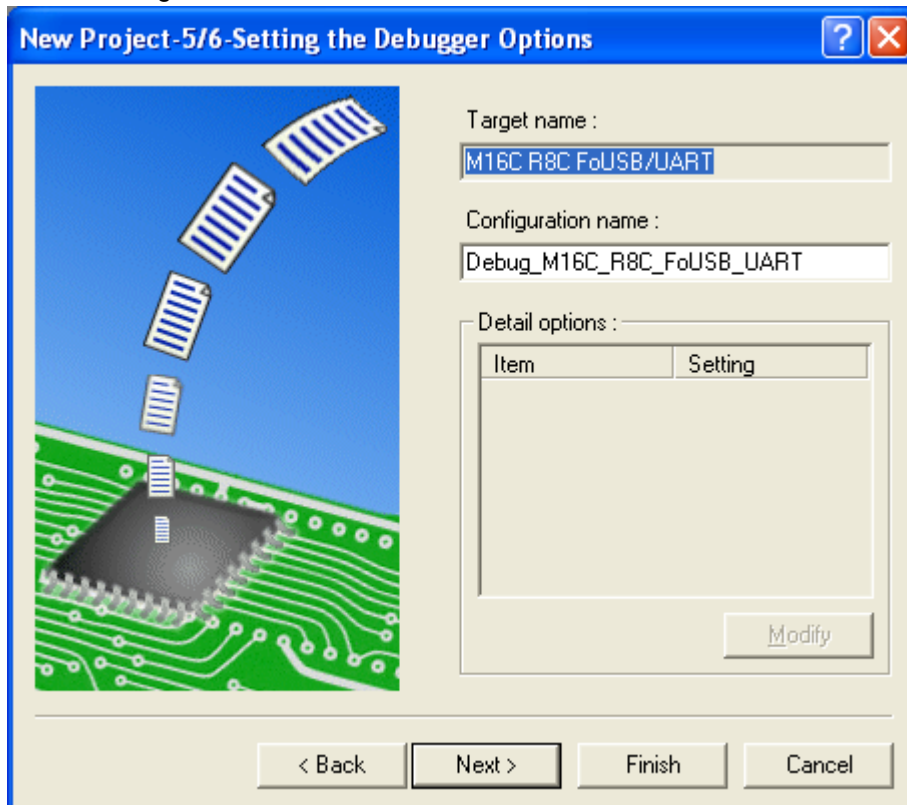

- i) Verify the file names to be generated.

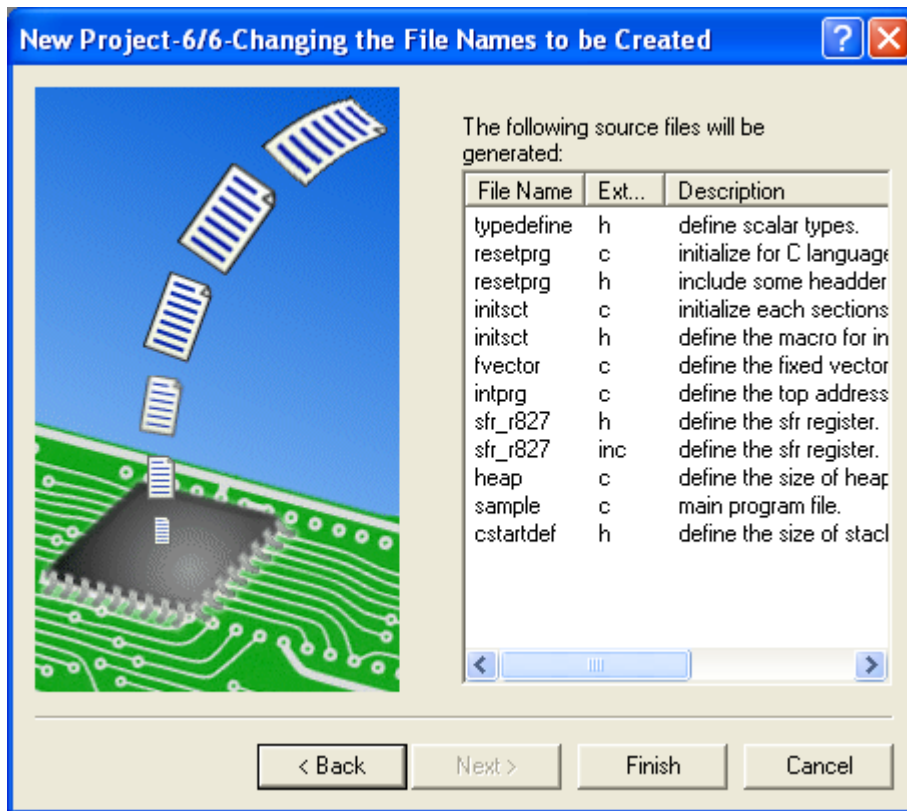

- j) The figure below displays the files generated by the High-performance Embedded Workshop based on the above settings. Pressing [OK] launches High-performance Embedded Workshop.

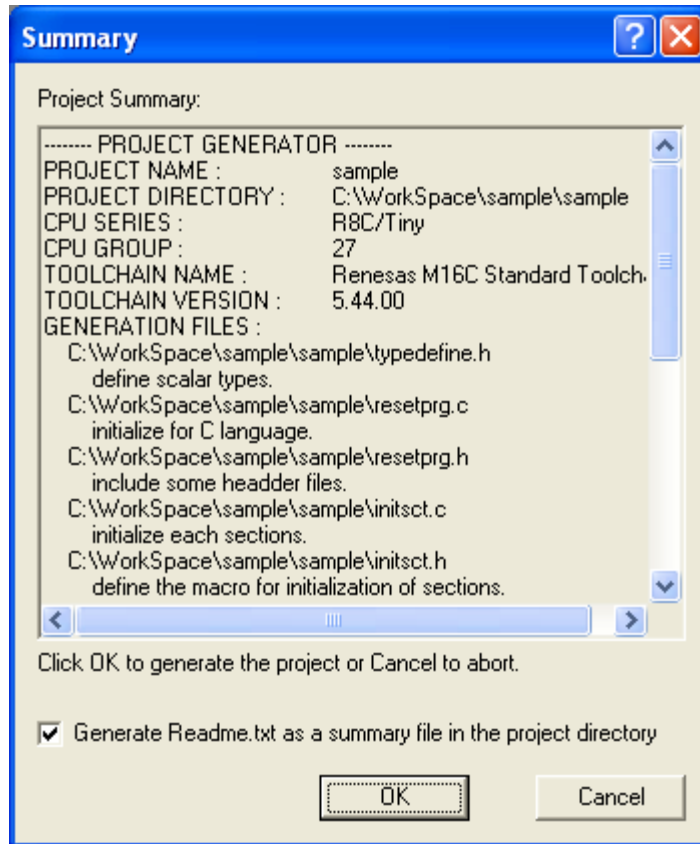

- k) Check the section address. Under the “Build” menu, select “Renesas M16C Standard Toolchain”.

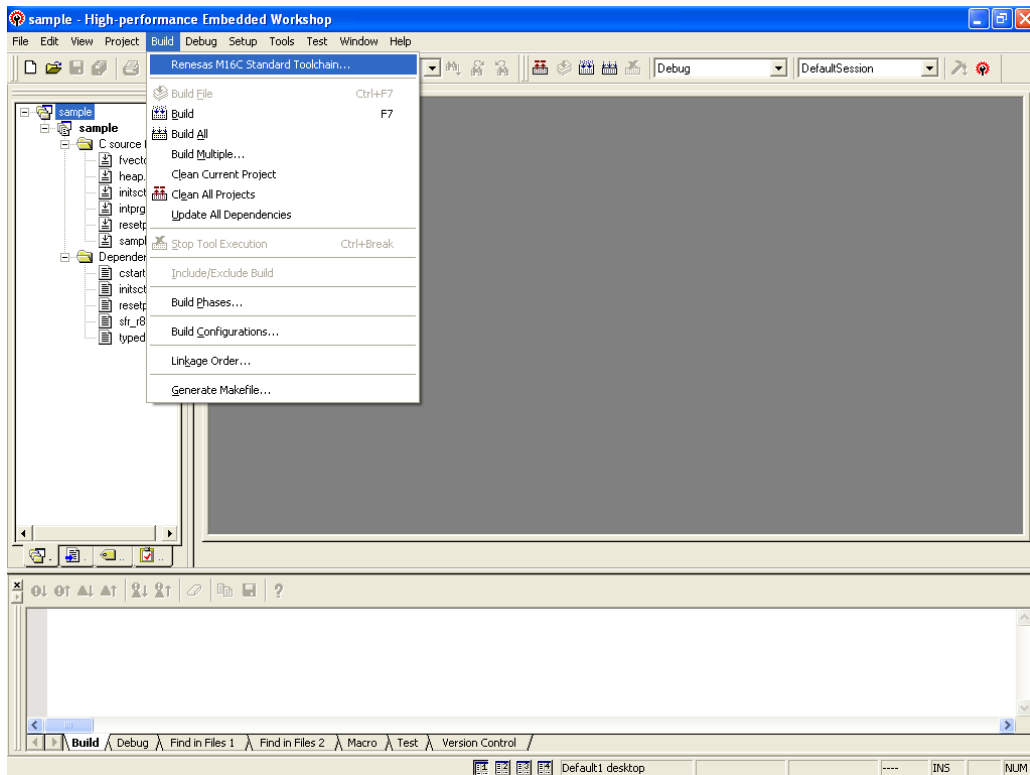

- l) “Renesas M16C Standard Toolchain” is displayed. Click on the “Link” tab and select “Section Order” from the “Category” pull-down menu. Make sure the section start address does not overlap with the monitor program occupied area shown in Table 1. If there is any overlap, edit the address value.

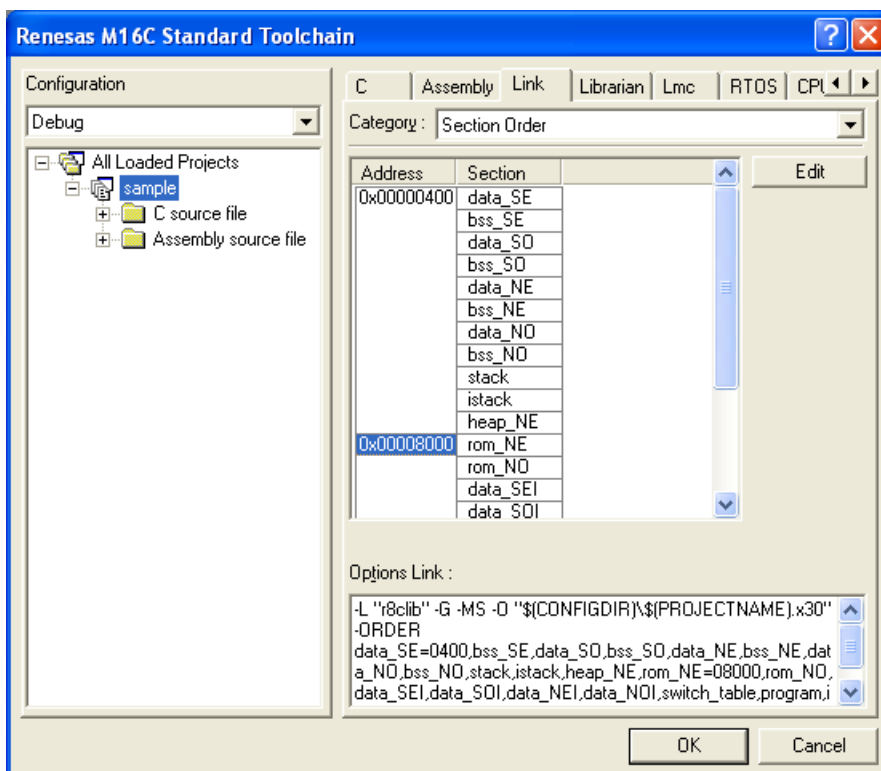

m) Double-click the source program to launch the program editor.

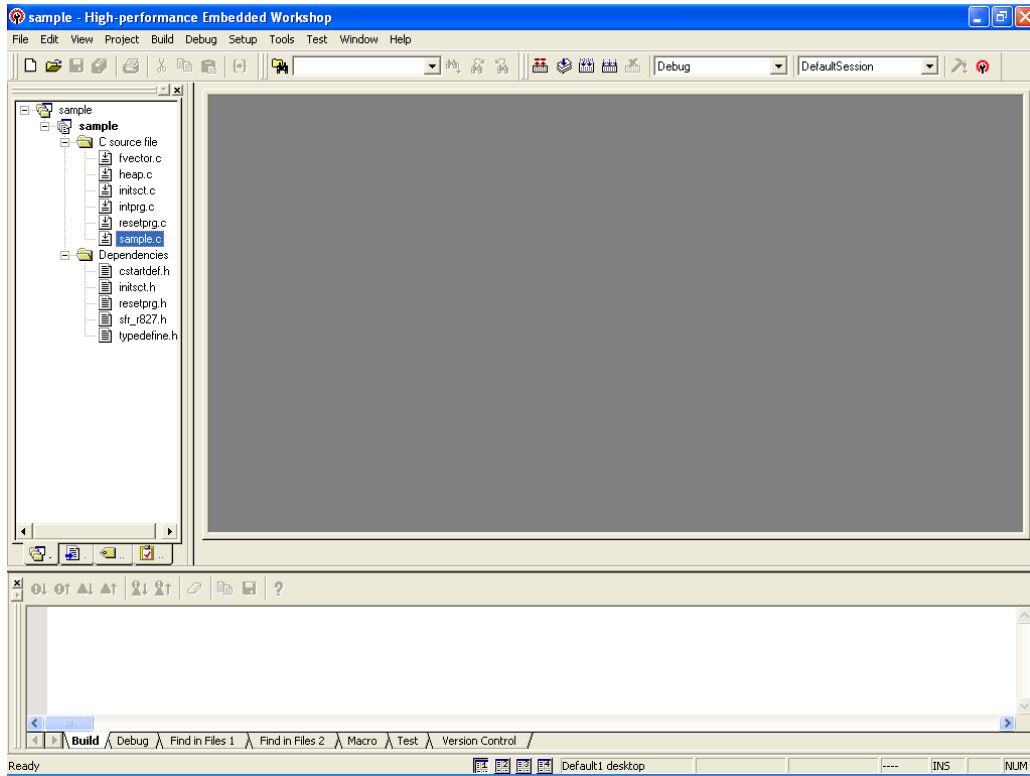

n) When the program is complete, under the “Build” menu, select “Build” or “Build All” to build the program.

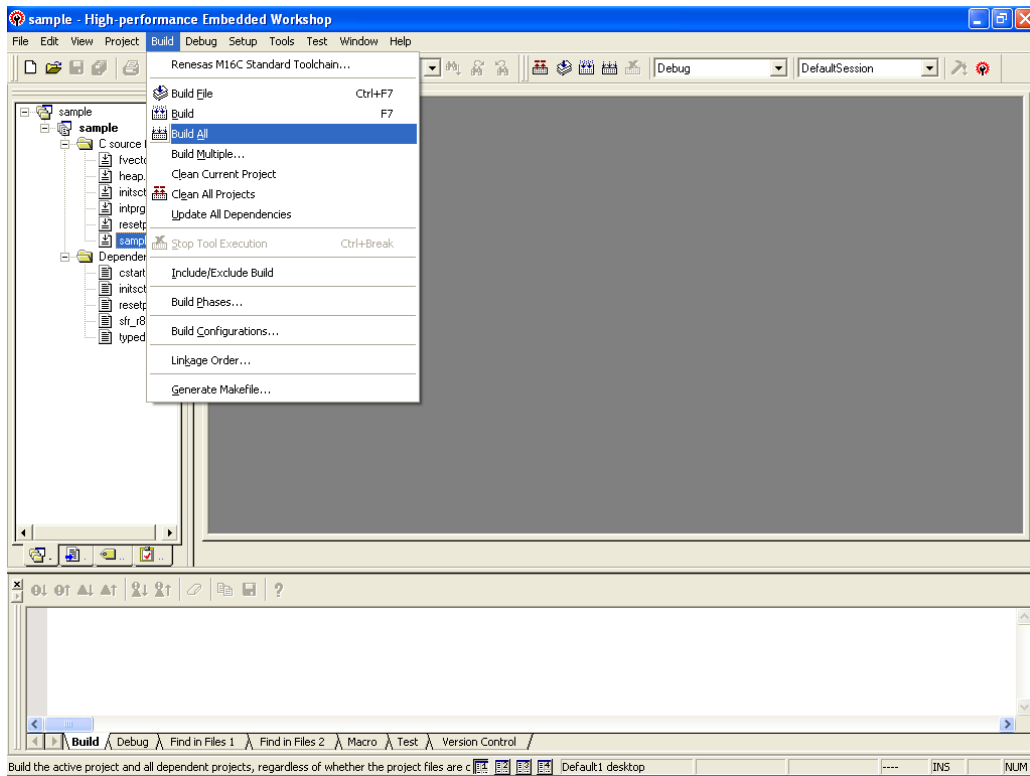



o) The result of the build is displayed.

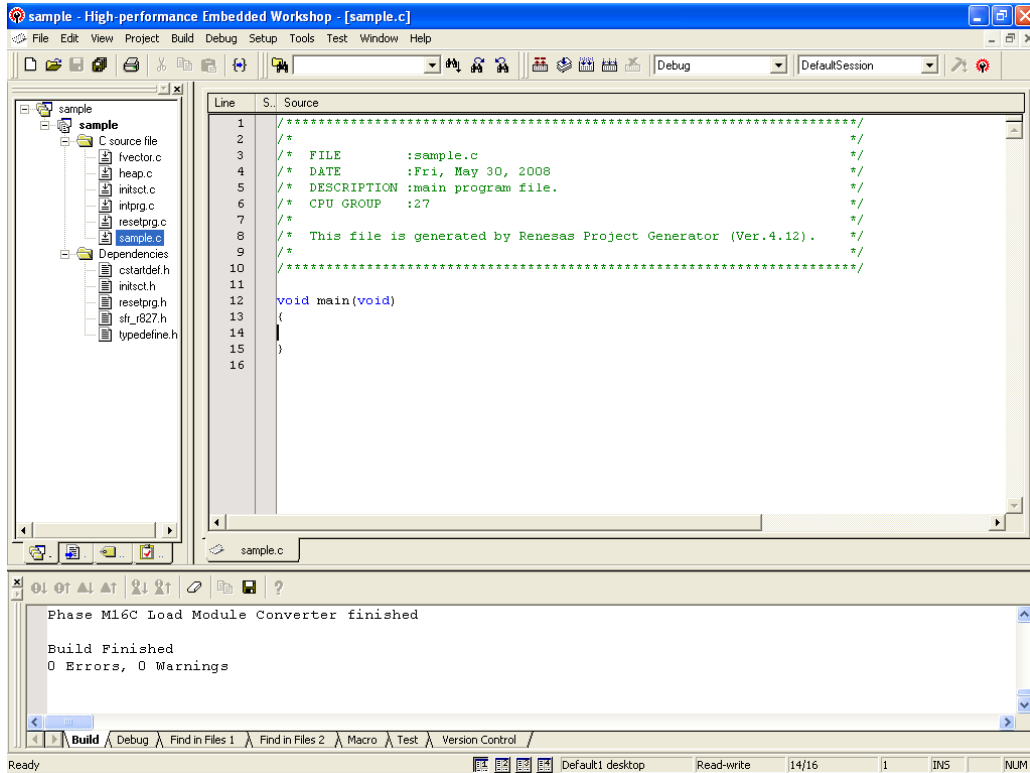

p) Connect with the target. A host computer can be connected with the target easily by switching to the session file in which the setting to use the R8C UART debugger is pre-registered.

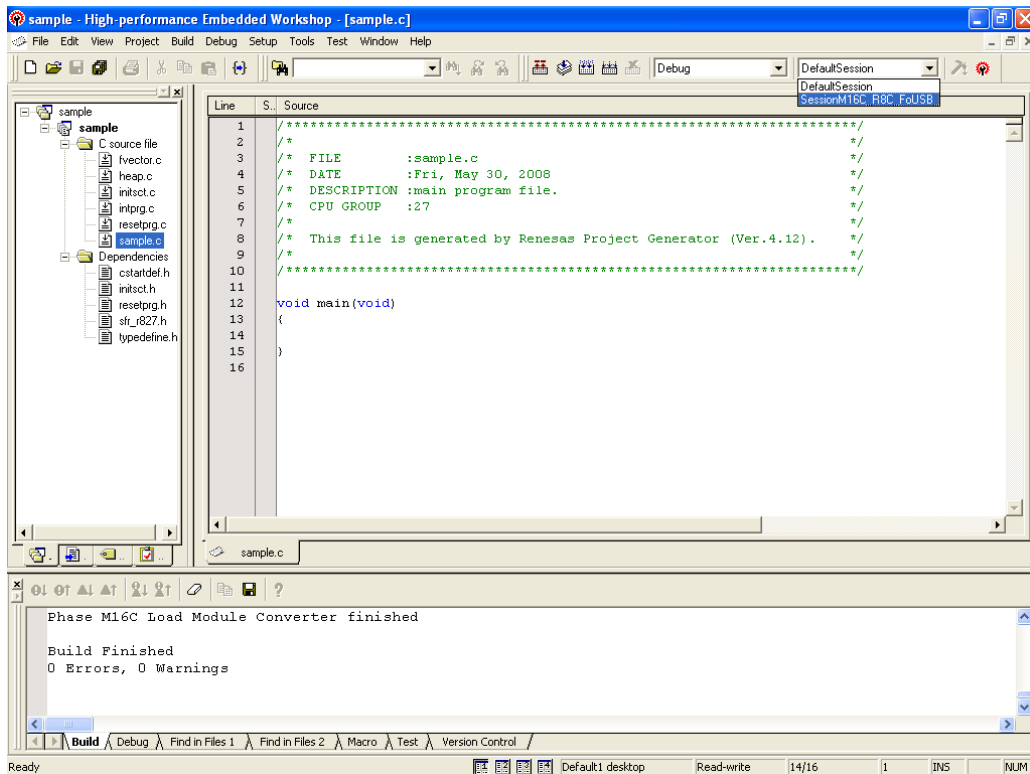

q) The Init screen is displayed. Select the “Serial” radio button and press [Refer(ence)].

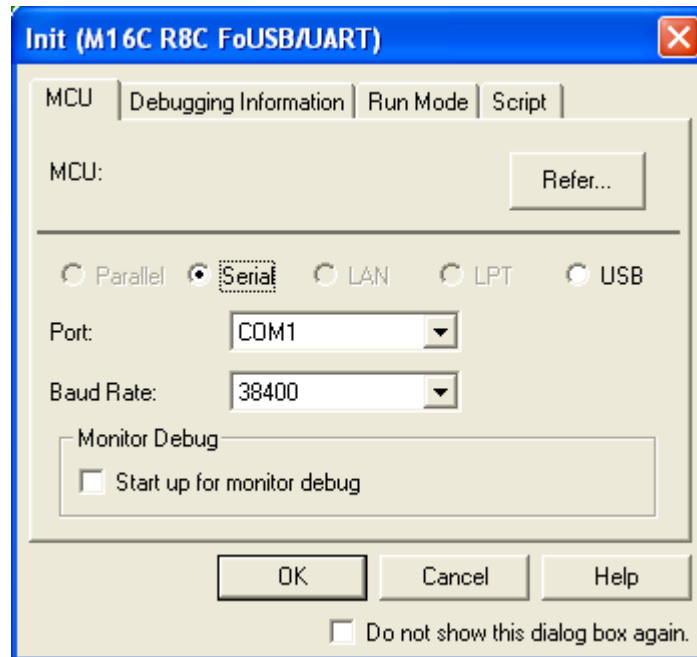

r) Select “R8C-Tiny Series”.

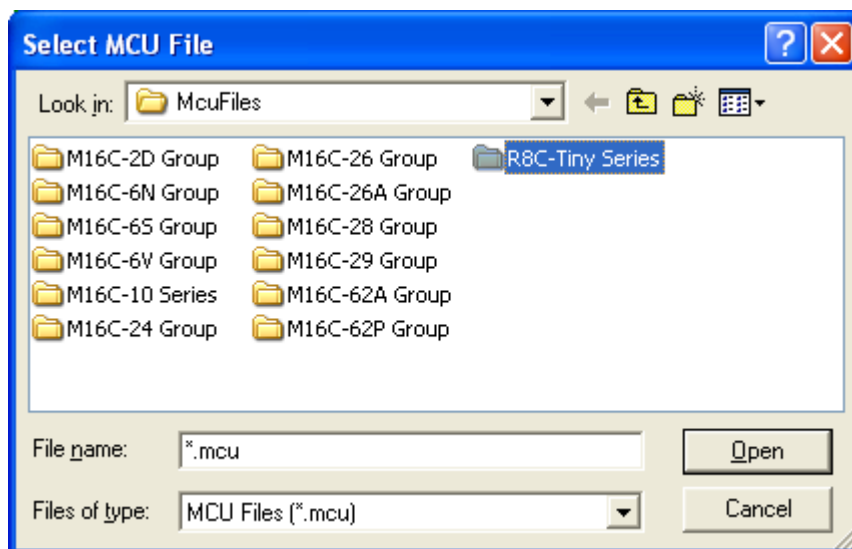

- s) Select one of the following MCU files depending on the group.
- R8C/2G Group: R5F212G6UART.MCU
  - R8C/2H Group: R5F212H2UART.MCU
  - R8C/2J Group: R5F212J1UART.MCU

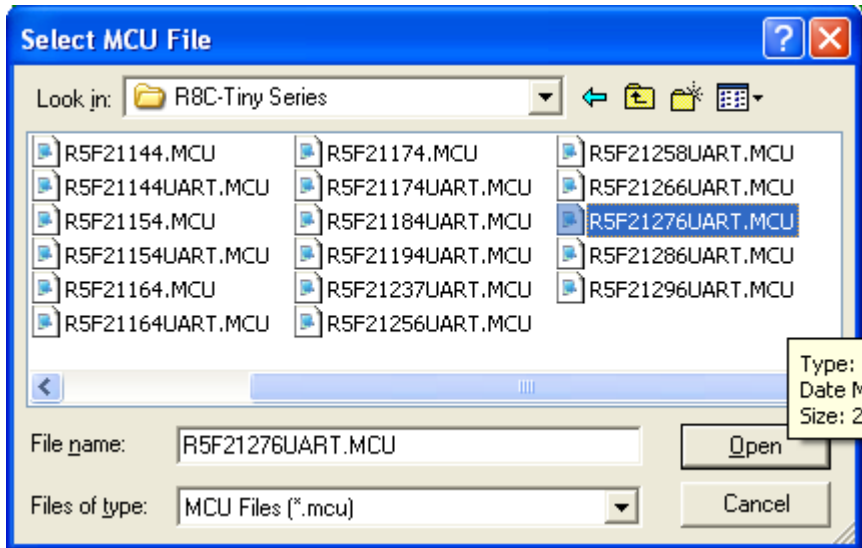

In this example, R8C/27 Group is selected.

- t) Select the appropriate "Port" and "Baud Rate" from the pull-down menus. Press [OK] and a monitor program is downloaded.

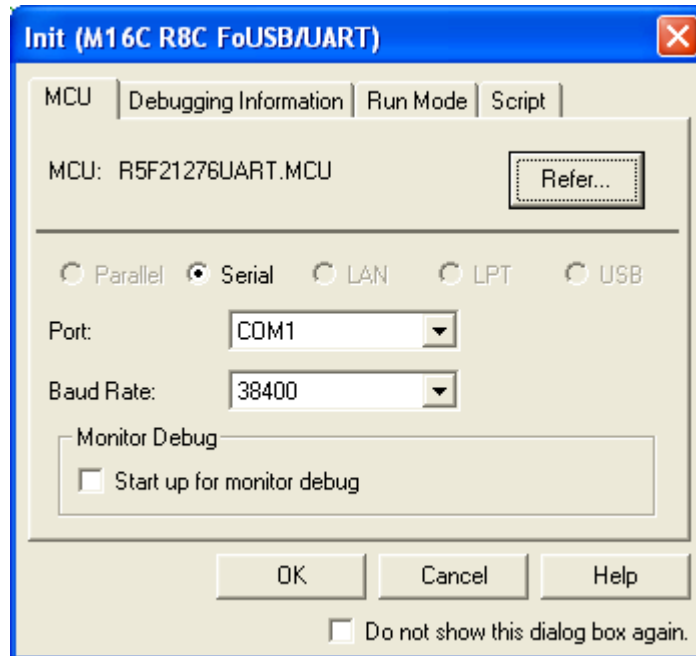

- u) To download a user program, select “Download File (X30 file)” in the “Download Modules” submenu under the “Debug” menu.

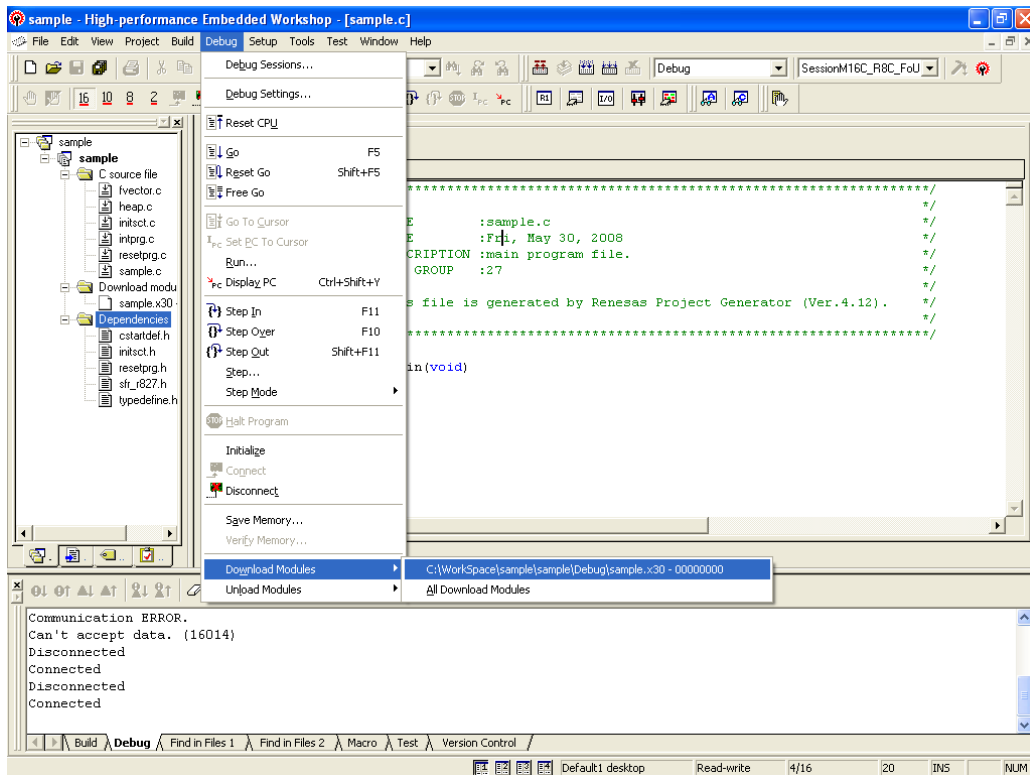

- v) To reset the user program, select “Reset CPU” under the “Debug” menu.

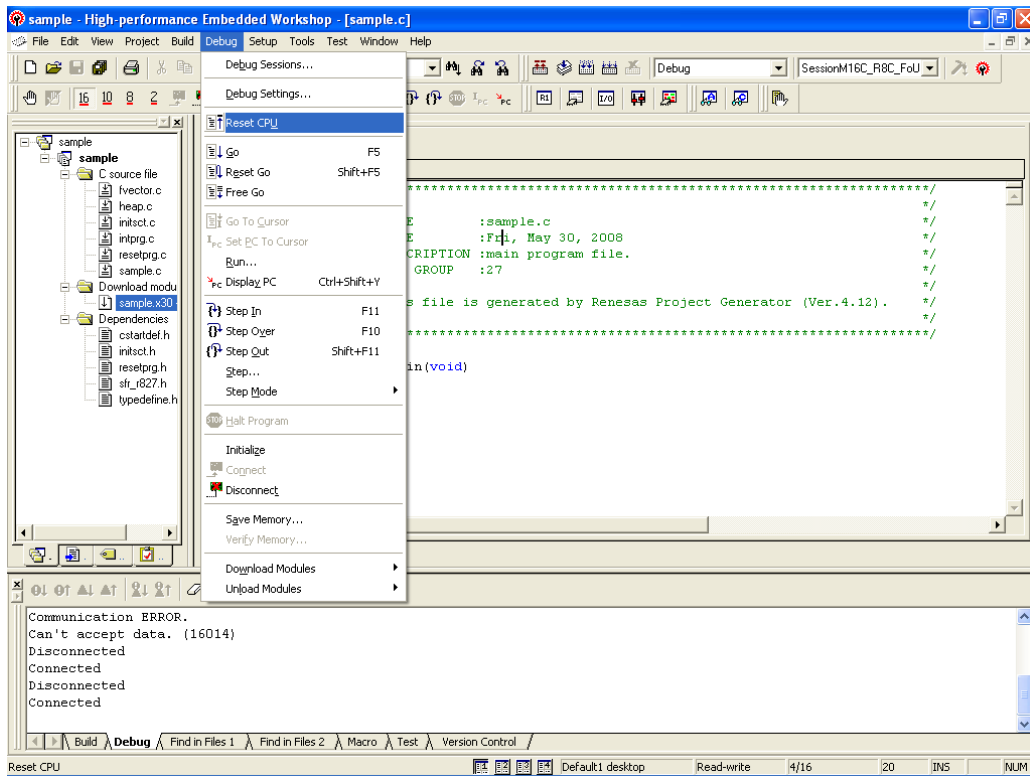

w) The cursor moves to the top of the user program and debugging starts.

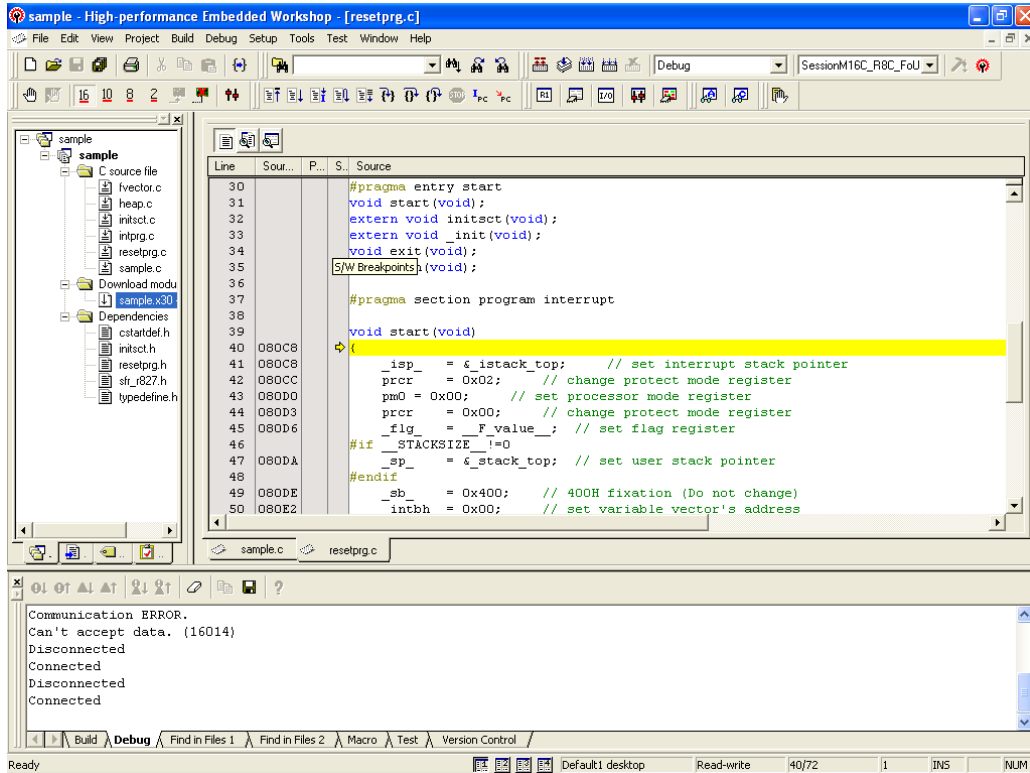

### 3. Memory Map When Using the R8C UART Debugger

Figure 4 shows a memory map (32 KB).

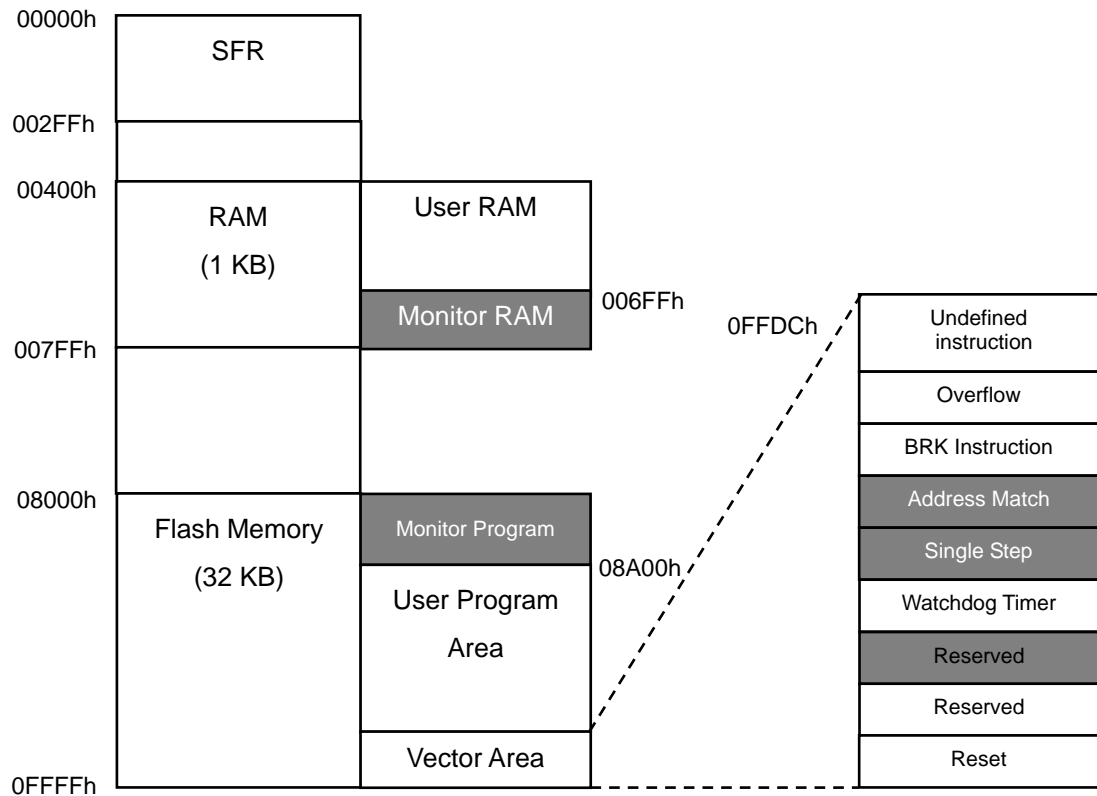

Note:  are monitor program occupied areas

**Figure 4 Memory Map (32 KB)**

## 4. Monitor Program Occupied Area

**Table 1 Monitor Program Occupied Area**

ROM / RAM	Occupied Area for Monitor Program	
4 KB / 256 B	Vector	FFE8h to FFEBh, FFECCh to FFEFh, FFF4h to FFF7h
8 KB / 386 B	Vector	FFE8h to FFEBh, FFECCh to FFEFh, FFF4h to FFF7h
16 KB / 512 B	Vector	FFE8h to FFEBh, FFECCh to FFEFh, FFF4h to FFF7h
24 KB / 1 KB	RAM	6FFh to 7FFh
	Vector	FFE8h to FFEBh, FFECCh to FFEFh, FFF4h to FFF7h
32 KB / 1 KB	RAM	6FFh to 7FFh
	Flash memory	8000h to 89FFh
	Vector	FFE8h to FFEBh, FFECCh to FFEFh, FFF4h to FFF7h

## 5. Notes on Using the R8C UART Debugger

### 5.1. Changing communication speed and restarting the R8C UART debugger after the R8C UART debugger is done

The target MCU holds the baud rate value after the R8C UART debugger is done. Therefore, when changing communication speed and restarting the R8C UART debugger, a communication error occurs. (The R8C UART debugger can be started when using the previous communication speed). When changing communication speed, turn off the target power and turn on the power again.

### 5.2. User program ID code

Set the ID code of the user program to **all FFh** when using the R8C UART debugger.

**Table 2 ID Code Storing Address**

Address	ID No.	Vector Table
0FFDFh – 0FFDCh	ID1	Undefined instruction
0FFE3h – 0FFE0h	ID2	Overflow
0FFE7h – 0FFE4h		BRK instruction
0FFEBh – 0FFE8h	ID3	Address match
0FEFh – 0FFECCh	ID4	Single step
0FFF3h – 0FFF0h	ID5	Watchdog timer, oscillation stop detection, voltage monitor 2
0FFF7h – 0FFF4h	ID6	Reserved
0FFFBh – 0FFF8h	ID7	Reserved
0FFFFh – 0FFFCh	(See Note)	Reset

Note: Refer to the hardware manual for the value set to address 0FFFFh.

### 5.3. User program download area

As shown in Figure 4, a monitor program uses a part of RAM or flash memory when using the R8C UART debugger. The R8C UART debugger does not download a user program only in the area which overlaps with a monitor program. Note that the R8C UART debugger does not output an error at this time. When outputting an error, set the following.

- a) Make "firm.c" and enter the following:

```
#include "typedefine.h"

#ifdef __UART__

#pragma section bss FirmArea
_far _UBYTE _firmarea[0xA00];

#endif
```

- b) Add the file created above to the project. Under the "Project" menu select "Add Files...". When the file selection screen is displayed, select "firm.c".

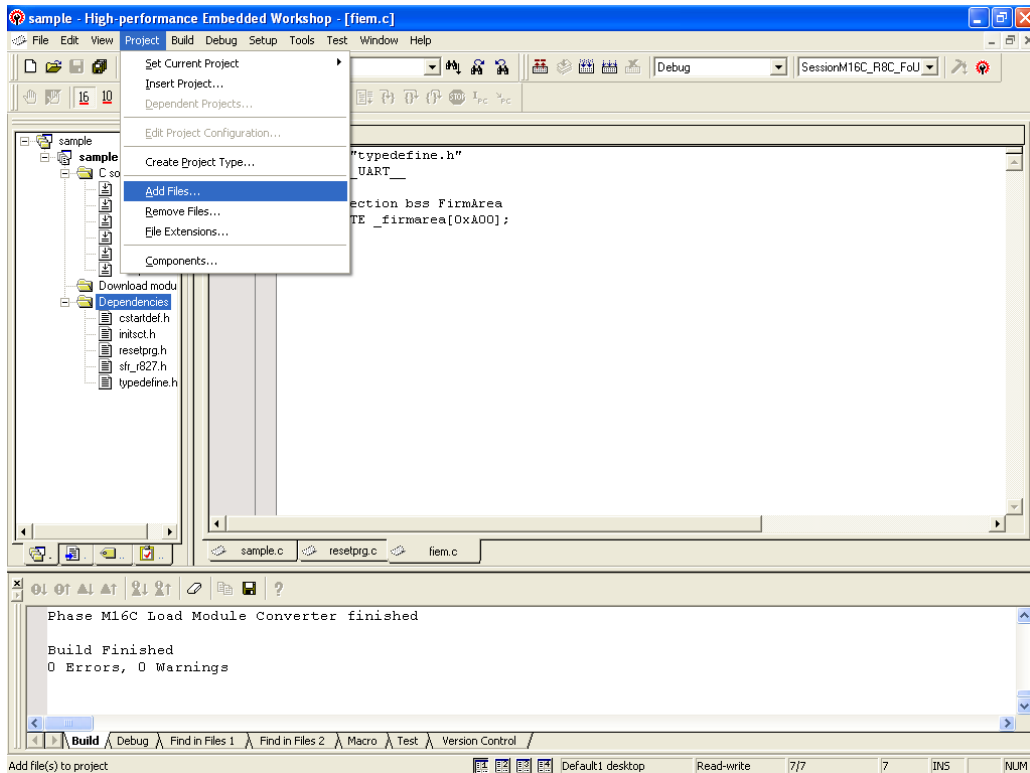



- c) To add the compile option, select “Renesas M16C Standard Toolchain...” under the “Build” menu.

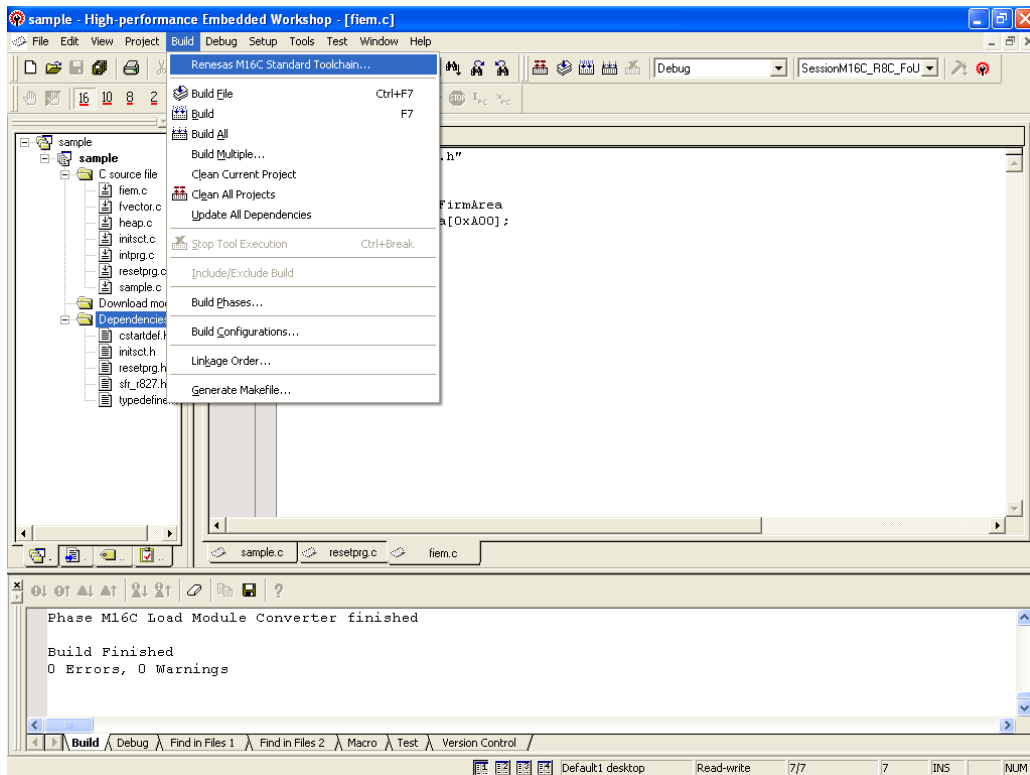

- d) “Renesas M16C Standard Toolchain” is displayed. Select “Defines” from the “Show Entries For” pull-down menu, and then press [Add...].

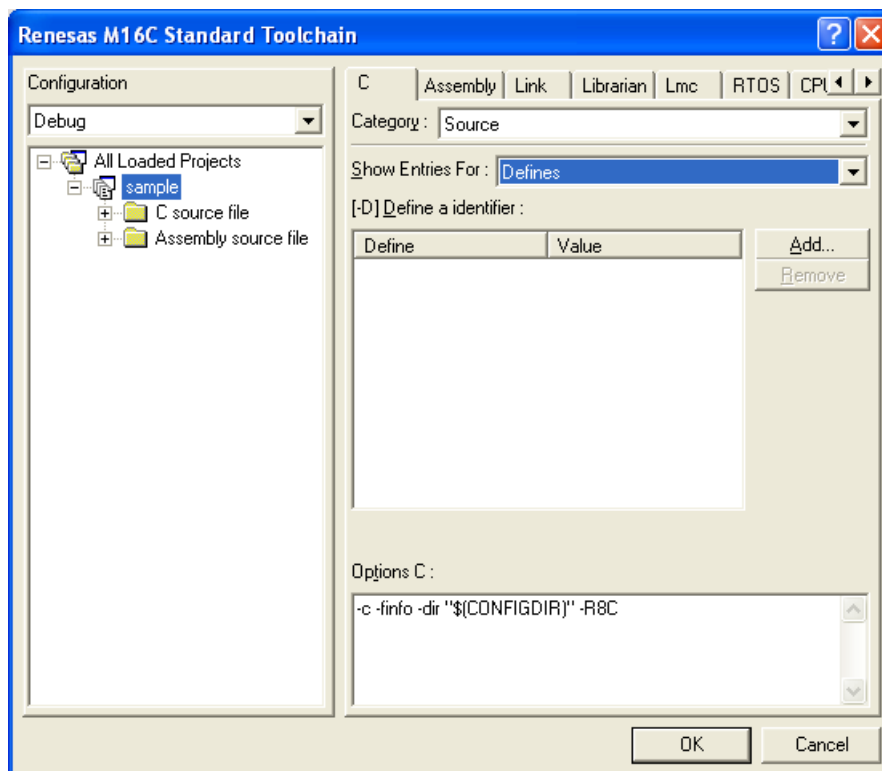

- e) "Set defined macro" is displayed. Enter "\_UART\_" in the "Macro" field and press [OK].

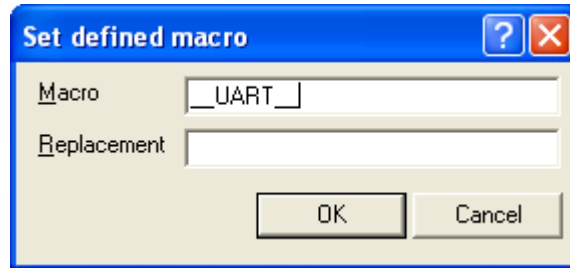

- f) To set the link option, in the "Renesas M16C Standard Toolchain" window, click on the "Link" tab and select "Section Order" from the "Category" pull-down menu. Add "FirmArea\_NE" to the start address of the monitor program occupied area shown in Table 1.

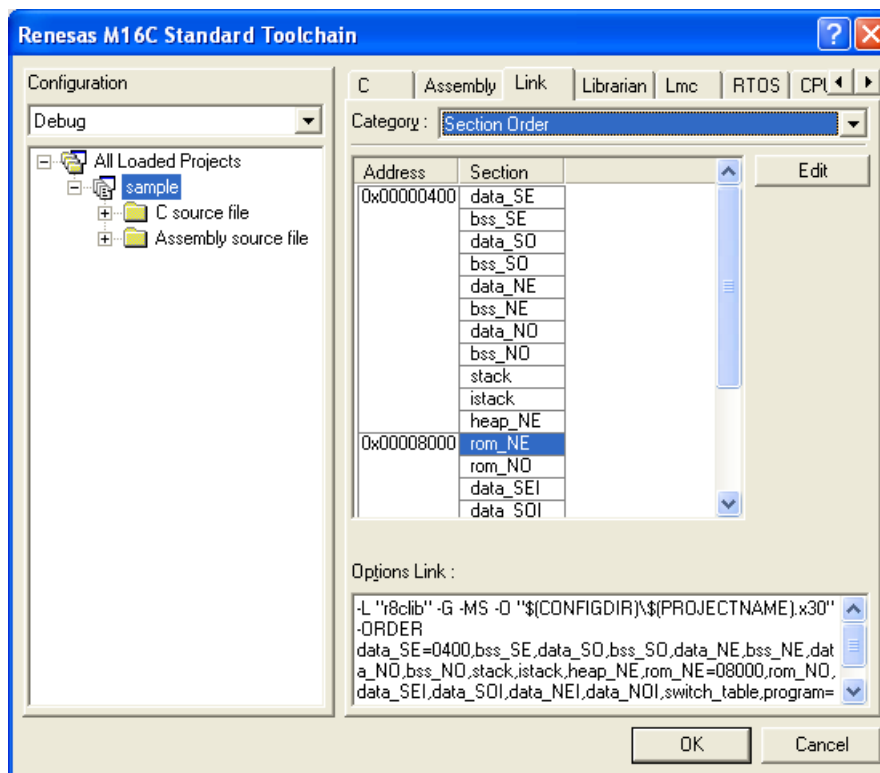

When the user program overlaps with the monitor program occupied area due to the above settings, an error is output.

#### 5.4. Frequency characteristics

The monitor program operates with the high-speed on-chip oscillator, 8 MHz. Do not select low-speed on-chip oscillator or Xcin clock as a main clock.

Table 3 lists communication available speed of the monitor program. Note that operation may not be possible when dividing the main clock.

**Table 3 Communication Available Speed**

Communication Speed (bps)					
1200	2400	4800	9600	19200	38400
X	O	O	O	O	O

O: Communication available

X: Communication not available

Note: Communication may not be possible depending on temperature and voltage. If communication is not possible, lower the communication speed.

## 5.5. Limitations of SFR operations

Table 4 lists the limitations of register operations. Changing registers that are disabled will cause the monitor program to malfunction.

**Table 4 Limitations on SFR Operation**

Register	Default Value	Limitation	Change
Processor Mode Register 0	Reset to 00h	Single-chip mode only	Partially enabled
Processor Mode Register 1	Reset to 00h	—————	Enabled
System Clock Control Register 0	Reset to 08h	Set the CM05 bit to 0.	Partially enabled
System Clock Control Register 1	Reset to 28h	Set bits CM13 and CM15 to 1. Set the CM14 bit to 0.	Partially enabled
High-Speed On-Chip Oscillator Control Register 0	Reset to 03h	Set the FRA00 bit to 1.	Partially enabled
High-Speed On-Chip Oscillator Control Register 1	—————	Do not change this register.	Disabled
High-Speed On-Chip Oscillator Control Register 2	Reset to 03h	—————	Enabled
Oscillation Stop Detection Register	Reset to 00000x00b	Set this register to 00h.	Partially enabled
Protect Register	—————	—————	Enabled
Flag Register	—————	Writing to the D flag is ignored. Do not set the D flag to 1.	Partially enabled
ISP (Interrupt Stack Pointer)	Reset to 057Fh	Set an area not used by the monitor program.	Partially enabled

## 5.6. Limitations on stop mode and wait mode

When using stop mode or wait mode, start the R8C UART debugger in free-run mode, and close the RAM window, C watch window, and ASM window in advance. Also, do not operate the R8C UART debugger until the program stops at the break point by setting the break point after exiting stop mode or wait mode.

## 5.7. Watchdog timer

The watchdog timer is refreshed while the monitor program is running. When using the watchdog timer while running the user program, note that by referring to or changing memory content, the monitor program intervenes and the watchdog timer is refreshed.

## 5.8. Real-time operation of user program

- Sampling run mode (also known as sampling mode)

In sampling mode, execution status of the user program will be regularly monitored when executing Go and Come. Therefore, it is possible to detect when the user program is stopped by a break or other command. Select this mode when performing a normal debug.

- Free run mode

In free run mode, execution status of the user program will not be monitored when executing Go and Come. Although real-time operation of the user program is secure, it is not possible to detect if the user program is stopped by a break or other command. Therefore, even when the user program stops, the R8C UART debugger does not stop executing Go and Come. Press STOP to stop the R8C UART debugger.

Note: In free run mode, use the R8C UART debugger while the RAM window, C watch window, and ASM window are closed.

## 5.9. Executing anomalistic steps

- Software interrupt instruction

The step execution cannot be performed continuously to the instruction internal process of the instructions (undefined instruction, overflow, BRK instruction, and INT instruction) which generate the software interrupts.

Example: INT instruction

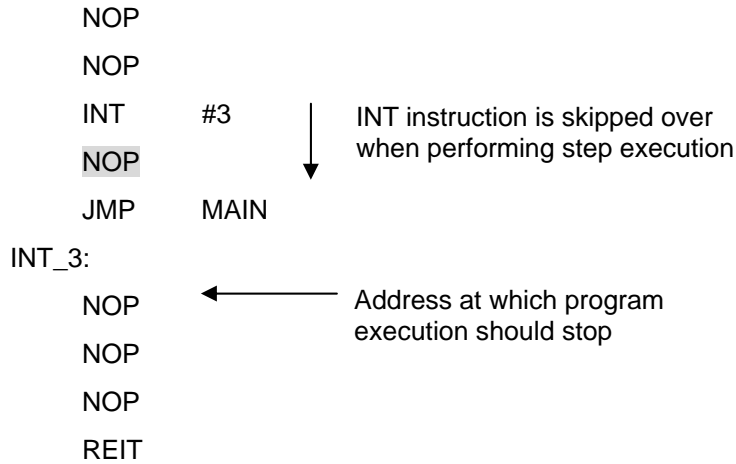

- INT instruction

To debug the program using the INT instruction, set the software break for the INT instruction process and use the Go command.

Example:

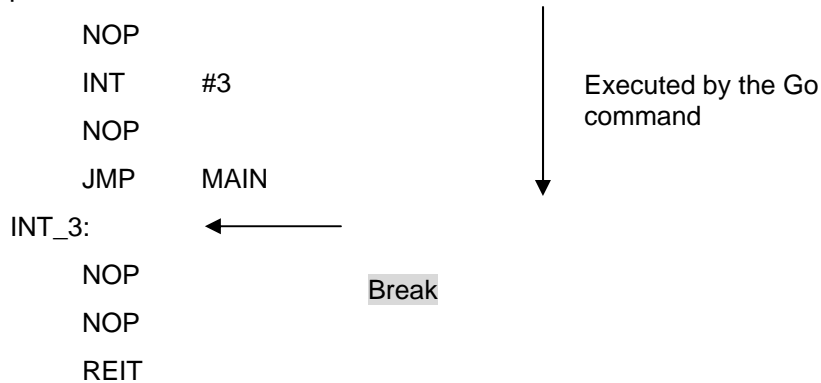

### 5.10. Limitations on peripheral functions

Do not connect the pins below to other pins as they are used for communication with the host computer.

- R8C/2G,2H, and 2J Groups  
P3\_7/TRAO/TRFO11 (2 pin), P4\_5/INT0 (9 pin)

### 5.11. Limitations on the flag register

When operating the flag register in a user program, execute the **FSET instruction and FCLR instruction** not to change the debug flag (D flag).

### 5.12. Operation on peripheral I/O during a break

Although an interrupt cannot be accepted during a break, peripheral I/O continues operating. For example, when stopping a user program by a break during operating a timer, the timer continues counting, but the timer interrupt cannot be accepted.

**REVISION HISTORY**

M16C R8C FoUSB/UART Debugger

Rev.	Date	Page	Description
			Summary
1.00	Dec. 12, 2008	-	First edition issued



---

M16C R8C FoUSB/ART Debugger User Manual  
Notes on Connecting R8C/2G, R8/2G, R8C/2J

Publication Date      Rev.1.00 Dec. 12, 2008  
Published by:         Sales Strategic Planning Div.  
                              Renesas Technology Corp.  
Edited by:             Renesas Solutions Corp.

# M16C R8C FoUSB/UART Debugger User's Manual



Renesas Electronics Corporation

1753, Shimonumabe, Nakahara-ku, Kawasaki-shi, Kanagawa 211-8668 Japan

REJ10J1966-0100