

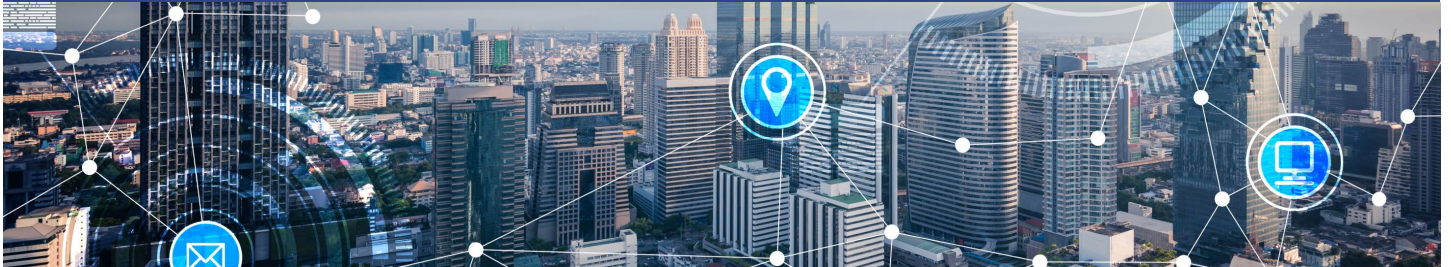









The Best Mix of Power Consumption and Performance

RENESAS RX200 MCU SERIES



RX200 MCU series is developed based on the RX proprietary core, delivering top level security and various functions such as HMI, Bluetooth and $\Delta\Sigma A/D$ needed in applications related in home appliance, industrial and IoT. This series has a good balance between high-speed processing by DSP / FPU and power consumption and is suitable for high-performance / energy-saving equipment such as battery powered equipment.

Consumer (battery drive)	Healthcare	Industrial	Home appliances
Digital cameras Gadgets	Wearable devices Blood glucose meter	Power meters Pressure, temperature, and flow volume meters Inverters	Air conditioners Refrigerators Washing machines
 	 	 	  

Benefits/ Key Features

High processing performance and excellent power consumption

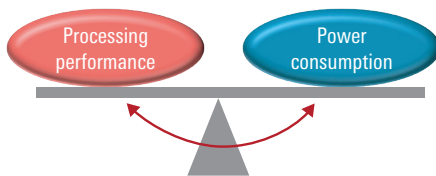

- Ideal for battery powered applications and high-performance and energy saving equipment
- DSP/FPU, enhanced by RXv2 core, provides high-speed calculation
- Operating current: **0.12mA/MHz**
- RAM holding standby current: **0.8 μ A**

Equipped with Functions Easily Developed for Home Appliances, Industry, and IoT

Apprication	Group	Touch	Bluetooth	Security	$\Delta\Sigma A/D$	5V
General	RX231	✓	-	✓	-	✓
	RX230	✓	-	-	-	✓
Home · OA	RX23W	✓	✓	✓	-	-
Measuring equipment	RX23E-A	-	-	-	✓	✓

Supporting IoT with Abundant Communication Functions and Advanced Security



- CAN For FA applications. Highly reliable maximum 1Mbps communication
- USB Connection with PC, F / W update with USB memory
- SDHI Easy connection to wireless module such as WiFi, WiSUN, BLE
- SSI Audio data Tx/Rx (I²S standard compliant)
- Bluetooth Low Energy Realize new functions by communicating with smartphones, etc.

RENESAS RX200 MCU SERIES

Product Information

Product	RX Core	FPU	Frequency/Flash	Peripheral Functions						
RX23W	RXv2	Single Precision	54MHz/512KB	CAN	USB	SDHI	Touch Key	SSI	Trusted secure IP Lite	Bluetooth
RX23E-A	RXv2	Single Precision	32MHz/256KB	CAN	-	-	-	-	-	High Precision AFE
RX231	RXv2	Single Precision	54MHz/512KB	CAN	USB	SDHI	Touch Key	SSI	Trusted secure IP Lite	-
RX230	RXv2	Single Precision	54MHz/256KB	-	-	-	Touch Key	SSI	-	-

Solution/ Development Environment

Bluetooth Solution

Facilitates the development of Bluetooth Low Energy

Jumpstart Bluetooth Low Energy development immediately with RX development boards, protocol stacks and evaluation tools.

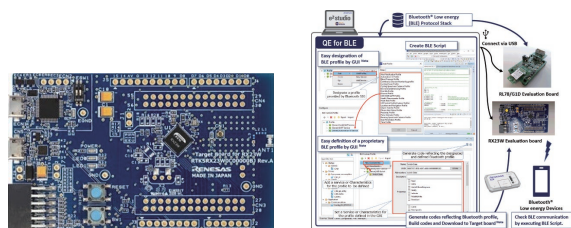

Target board for RX23W

QE for BLE

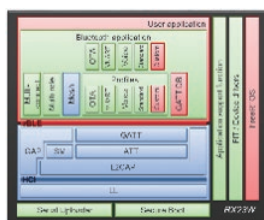

Bluetooth Low Energy Protocol stack

Security Solution

Peace of mind for the product

TSIP technology protects products from counterfeit, eavesdropping, spoofing, tampering by hijacking, etc.

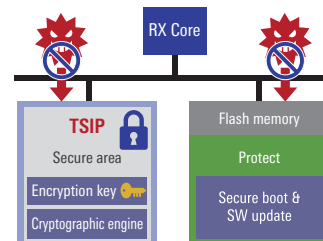

Touch Key Solution

Lower Touch Key development barriers

HMI Kit can evaluation Touch function, segment LCD and audio playback.

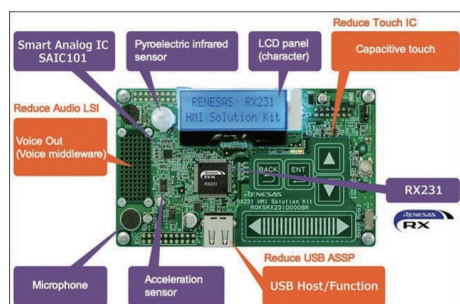

High-Precision Analog Front-end Development Support Tool

Accurate and easy evaluation of analog performance

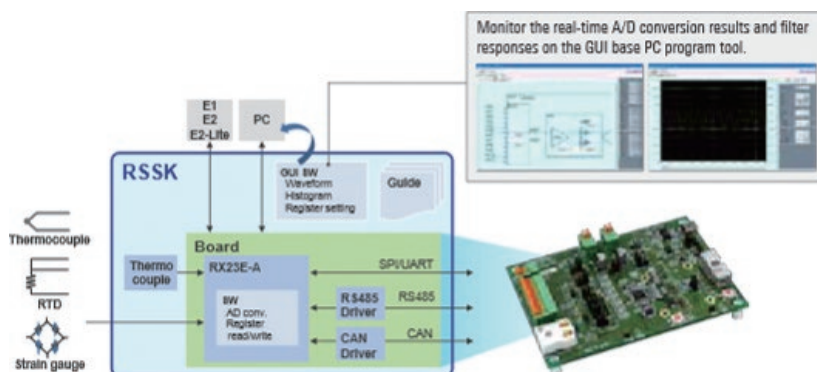

Long-term Product Supply Program

Renesas Electronics operates a long-term product supply program (commonly known as PLP: Product Longevity Program) so that customers with long equipment life cycles can select products with peace of mind. We will supply for up to 15 years.

For more details, please visit www.renesas.com/RX

Corporate Headquarters

TOYOSU FORESIA, 3-2-24 Toyosu, Koto-ku, Tokyo 135-0061, Japan
www.renesas.com

Trademarks

EtherCAT® is a registered trademark and patented technology, licensed by Beckhoff Automation GmbH, Germany. Renesas and the Renesas logo are trademarks of Renesas Electronics Corporation. All trademarks and registered trademarks are the property of their respective owners.

Contact information

For further information on a product, technology, the most up-to-date version of a document, or your nearest sales office, please visit: www.renesas.com/contact/