

ISL80505

High Performance 500mA LDO

FN8770

Rev 1.00

November 10, 2016

The [ISL80505](#) is a single output Low Dropout voltage regulator (LDO) capable of sourcing up to 500mA output current. This LDO operates from input voltages of 1.8V to 6V. The output voltage of ISL80505 can be programmed from 0.8V to 5.5V.

A submicron BiCMOS process is utilized for this product family to deliver the best in class analog performance and overall value. This CMOS LDO consumes significantly lower quiescent current as a function of load compared to bipolar LDOs, which translates into higher efficiency and packages with smaller footprints.

State-of-the-art internal compensation achieves a very fast load transient response and excellent PSRR. The ISL80505 provides an output accuracy of $\pm 1.8\%$ V_{OUT} accuracy over all load, line and temperature variations ($T_J = -40^\circ\text{C}$ to $+125^\circ\text{C}$). An external capacitor on the soft-start pin provides an adjustable soft starting of the output voltage ramp to control the inrush current. The ENABLE feature allows the part to be placed into a low quiescent current shutdown mode.

[Table 1](#) shows the differences between the ISL80505 and others in its family.

TABLE 1. KEY DIFFERENCES BETWEEN FAMILY OF PARTS

PART NUMBER	INPUT VOLTAGE RANGE	MAX OUTPUT CURRENT
ISL80510	2.2V to 6V	1.0A
ISL80505	1.8V to 6V	0.5A

Features

- $\pm 1.8\%$ V_{OUT} accuracy guaranteed over line, load, and $T_J = -40^\circ\text{C}$ to $+125^\circ\text{C}$
- Very low 45mV dropout voltage at $V_{OUT} = 2.5V$
- Stable with a 4.7 μF output ceramic capacitor
- Very fast transient response
- Programmable output soft-start time
- Excellent PSRR over wide frequency range
- Current limit protection
- Thermal shutdown function
- Available in an 8 Ld DFN package
- Pb-free (RoHS compliant)

Applications

- Noise sensitive instrumentation systems
- Post regulation of switched mode power supplies
- Industrial systems
- Medical equipment
- Telecommunications and networking equipment
- Servers
- Hard disk drives (HD/HDD)

Related Literature

- For a full list of related documents, visit our website - [ISL80505](#) product page

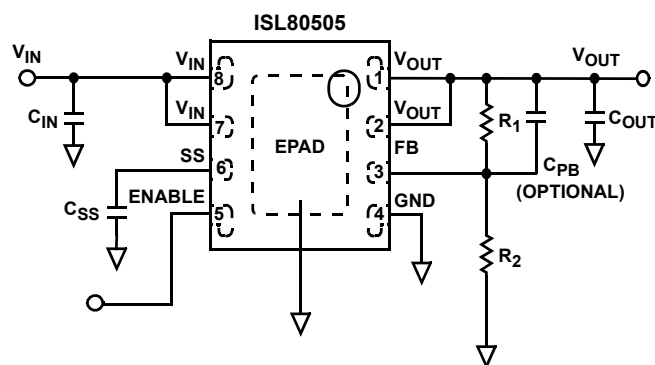

FIGURE 1. TYPICAL APPLICATION CIRCUIT

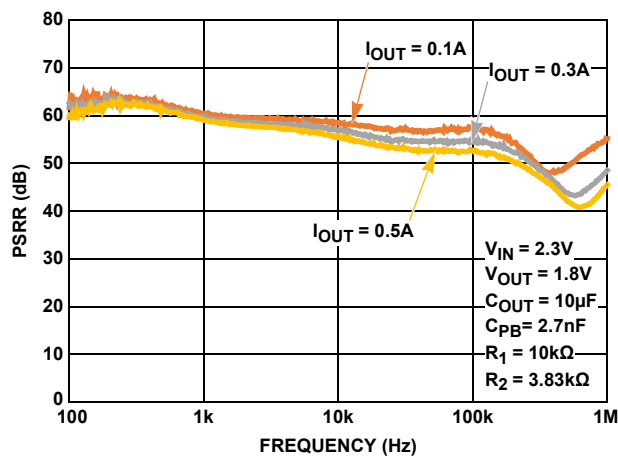

FIGURE 2. PSRR

Block Diagram

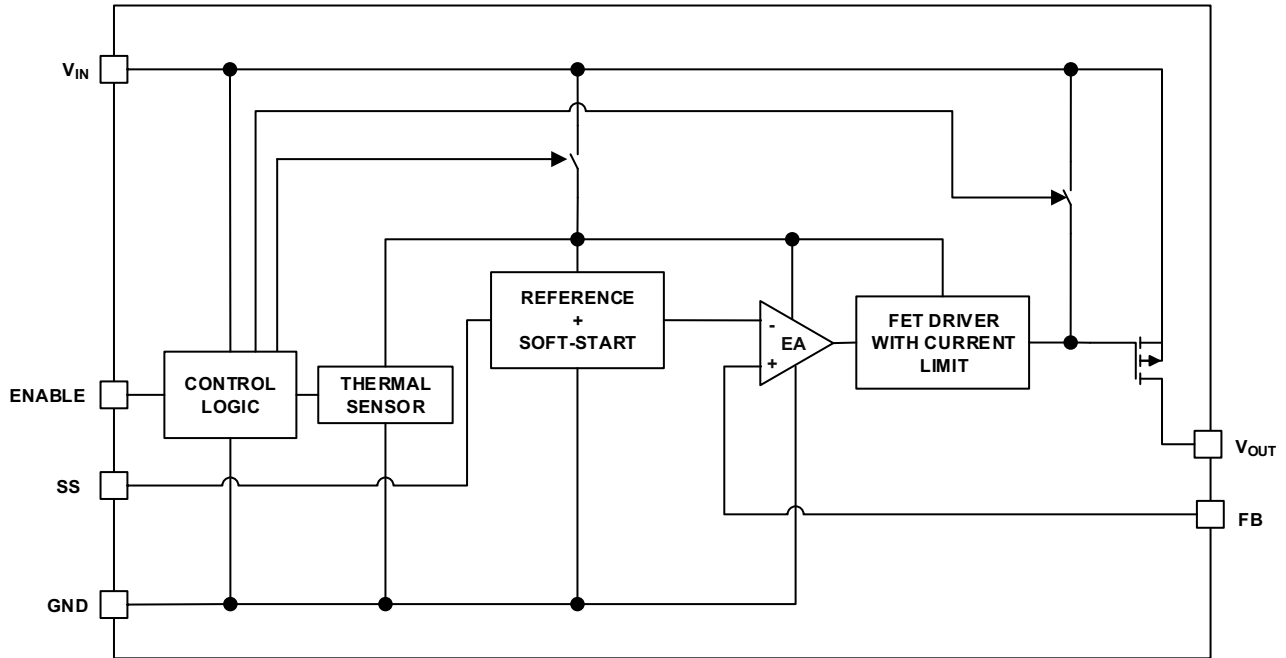

FIGURE 3. BLOCK DIAGRAM

Ordering Information

PART NUMBER (Notes 1, 2, 3)	PART MARKING	TEMP RANGE (°C)	PACKAGE (RoHS Compliant)	PKG DWG. #
ISL80505IRAJZ	0505	-40 to +125	8 Ld 3x3 DFN	L8.3X3J
ISL80510EVAL1Z	Evaluation Board			

NOTES:

1. Add "-T" suffix for 6k unit or "-T7A" suffix for 250 unit tape and reel options. Refer to [TB347](#) for details on reel specifications.
2. These Intersil Pb-free plastic packaged products employ special Pb-free material sets, molding compounds/die attach materials, and 100% matte tin plate plus anneal (e3 termination finish, which is RoHS compliant and compatible with both SnPb and Pb-free soldering operations). Intersil Pb-free products are MSL classified at Pb-free peak reflow temperatures that meet or exceed the Pb-free requirements of IPC/JEDEC J STD-020.
3. For Moisture Sensitivity Level (MSL), see device information page for [ISL80505](#). For more information on MSL see Technical Brief [TB363](#).

Pin Configuration

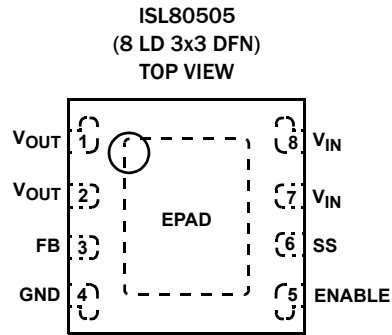

Pin Descriptions

PIN NUMBER	PIN NAME	DESCRIPTION
1, 2	V _{OUT}	Regulated output voltage. A minimum 4.7µF X5R/X7R output capacitor is required for stability. See "External Capacitor Requirements" on page 10 for more details.
3	FB	This pin is the input to the control loop error amplifier and is used to set the output voltage of the LDO.
4	GND	Ground
5	ENABLE	V _{IN} independent chip enable. TTL and CMOS compatible.
6	SS	External capacitor on this pin adjusts start-up ramp and controls inrush current.
7, 8	V _{IN}	Input supply; A minimum of 4.7µF X5R/X7R input capacitor is required for proper operation. See "External Capacitor Requirements" on page 10 for more details.
-	EPAD	EPAD at ground potential. It is recommended to solder the EPAD to the ground plane.

Absolute Maximum Ratings

V_{IN} Relative to GND (Note 4)	-0.3V to +6.5V
V_{OUT} Relative to GND (Note 4)	-0.3V to +6.5V
ENABLE, FB, SS Relative to GND (Note 4)	-0.3V to +6.5V
ESD Rating	
Human Body Model (Tested per JESD22 A114F)	2.5kV
Machine Model (Tested per JESD22 A115C)	250V
Charge Device Model (Tested per JESD22-C101C)	2kV
Latch-Up (Tested per JESD78C, Class 2, Level A)	± 100 mA at +85°C

Thermal Information

Thermal Resistance (Typical)	θ_{JA} (°C/W)	θ_{JC} (°C/W)
8 Ld DFN Package (Notes 5, 6)	48	7
Storage Temperature Range	-65°C to +150°C	
Junction Temperature	+150°C	
Pb-Free Reflow Profile	see TB493	

Recommended Operating Conditions (Notes 7, 8)

Junction Temperature Range (T_J)	-40°C to +125°C
V_{IN} Relative to GND	1.8V to 6V
V_{OUT} Range	800mV to 5.5V
ENABLE, FB, SS Relative to GND	0V to 6V

CAUTION: Do not operate at or near the maximum ratings listed for extended periods of time. Exposure to such conditions may adversely impact product reliability and result in failures not covered by warranty.

NOTES:

- Absolute maximum voltage rating is defined as the voltage applied for a lifetime average duty cycle above 6V of 1%.
- θ_{JA} is measured in free air with the component mounted on a high-effective thermal conductivity test board with "direct attach" features. See Tech Brief [TB379](#).
- For θ_{JC} , the "case temp" location is the center of the exposed metal pad on the package underside.
- Electromigration specification defined as lifetime average junction temperature of +110°C where maximum rated DC current = lifetime average current.
- The recommended operating condition for V_{IN} relative to GND is 1.8V to 6V for a junction temperature range of 0°C to +125°C. The recommended operating condition for V_{IN} relative to GND is 2.2V to 6V for a junction temperature range of -40°C to +125°C.

Electrical Specifications

Unless otherwise noted, 1.8V < V_{IN} < 6V, V_{OUT} = 0.5V, T_J = +25°C. Applications must follow thermal guidelines of the package to determine worst case junction temperature. Please refer to ["Applications Information" on page 10](#) and Tech Brief [TB379](#). **Boldface limits apply across the operating temperature range, -40°C to +125°C.**

PARAMETER	SYMBOL	TEST CONDITIONS	MIN (Note 9)	TYP	MAX (Note 9)	UNIT
DC CHARACTERISTICS						
Input Voltage	V_{IN}	0°C < T_J < +125°C	1.8		6.0	V
		-40°C < T_J < +125°C	2.2		6.0	V
Feedback Pin Voltage	V_{FB}	1.8V < V_{IN} < 6V; 0A < I_{LOAD} < 500mA	491	500	509	mV
Feedback Input Current		V_{FB} = 0.5V		0.01	1	μA
Line Regulation	$(V_{OUT(Low\ Line)} - V_{OUT(High\ Line)}) / V_{OUT(Low\ Line)}$	V_{IN} = 1.8V to 6V; I_{LOAD} = 100mA	-0.9		0.9	%
Load Regulation	$(V_{OUT(No\ Load)} - V_{OUT(Full\ Load)}) / V_{OUT(No\ Load)}$	V_{IN} = 2.2V; I_{LOAD} = 0A to 500mA	-0.7		0.7	%
Ground Pin Current	I_Q	I_{LOAD} = 0A, 1.8V < V_{IN} < 6V		2.2	4.6	mA
		I_{LOAD} = 500mA, 1.8V < V_{IN} < 6V		2.8	5.7	mA
Ground Pin Current in Shutdown	I_{SHDN}	ENABLE pin = 0V, V_{IN} = 6V		0.2	12	μA
Dropout Voltage (Note 10)	V_{DO}	I_{LOAD} = 500mA, V_{OUT} = 2.5V		45	90	mV
Output Short-Circuit Current	OCP	V_{OUT} = 0V	0.75	1.2	1.5	A
Thermal Shutdown Temperature	TSD			160		°C
Thermal Shutdown Hysteresis	TSDn			30		°C

Electrical Specifications Unless otherwise noted, $1.8V < V_{IN} < 6V$, $V_{OUT} = 0.5V$, $T_J = +25^\circ C$. Applications must follow thermal guidelines of the package to determine worst case junction temperature. Please refer to [“Applications Information”](#) on page 10 and Tech Brief [TB379](#). **Boldface limits apply across the operating temperature range, $-40^\circ C$ to $+125^\circ C$.** (Continued)

PARAMETER	SYMBOL	TEST CONDITIONS	MIN (Note 9)	TYP	MAX (Note 9)	UNIT
AC CHARACTERISTICS						
Input Supply Ripple Rejection	PSRR	$f = 1kHz, I_{LOAD} = 500mA; V_{IN} = 2.2V; V_{OUT} = 1.8V$		57		dB
		$f = 120Hz, I_{LOAD} = 500mA; V_{IN} = 2.2V; V_{OUT} = 1.8V$		60		dB
Output Noise Voltage		$V_{IN} = 2.2V; V_{OUT} = 1.8V; I_{LOAD} = 500mA, BW = 100Hz < f < 100kHz$		79		μV_{RMS}
ENABLE PIN CHARACTERISTICS						
Turn-On Threshold			0.5	0.8	1	V
Hysteresis			10	80	200	mV
ENABLE Pin Turn-On Delay		$C_{OUT} = 4.7\mu F, I_{LOAD} = 500mA$		100		μs
ENABLE Pin Leakage Current		$V_{IN} = 6V, ENABLE = 3V$			1	μA
SOFT-START CHARACTERISTICS						
SS Pin Currents (Note 11)	I_{PD}	$V_{IN} = 3.5V, ENABLE = 0V, SS = 1V$	0.5	1	1.3	mA
	I_{CHG}		-3.3	-2	-0.8	μA

NOTES:

- Parameters with MIN and/or MAX limits are 100% tested at $+25^\circ C$, unless otherwise specified. Temperature limits established by characterization and are not production tested.
- Dropout is defined as the difference in supply V_{IN} and V_{OUT} when the output is below its nominal regulation.
- I_{PD} is the internal pull-down current that discharges the external SS capacitor on disable. I_{CHG} is the current from the SS pin that charges the external SS capacitor during start-up.

Typical Operating Performance Unless otherwise noted: $V_{IN} = 2.2V, V_{OUT} = 1.8V, C_{IN} = C_{OUT} = 10\mu F, T_J = +25^\circ C, I_{LOAD} = 0A$.

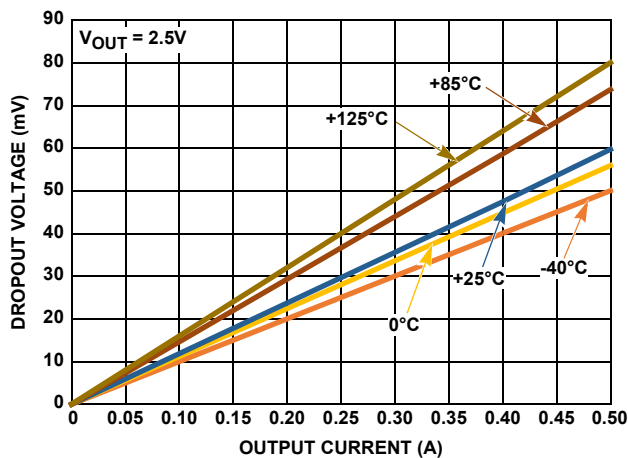

FIGURE 4. DROPOUT vs OUTPUT CURRENT

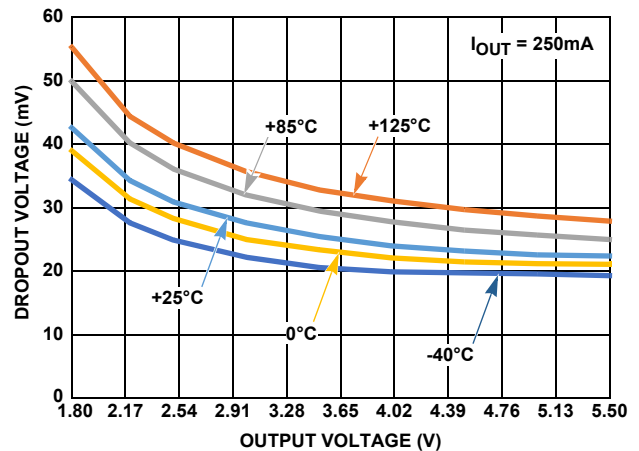

FIGURE 5. DROPOUT vs OUTPUT VOLTAGE

Typical Operating Performance

Unless otherwise noted: $V_{IN} = 2.2V$, $V_{OUT} = 1.8V$, $C_{IN} = C_{OUT} = 10\mu F$,
 $T_J = +25^\circ C$, $I_{LOAD} = 0A$. (Continued)

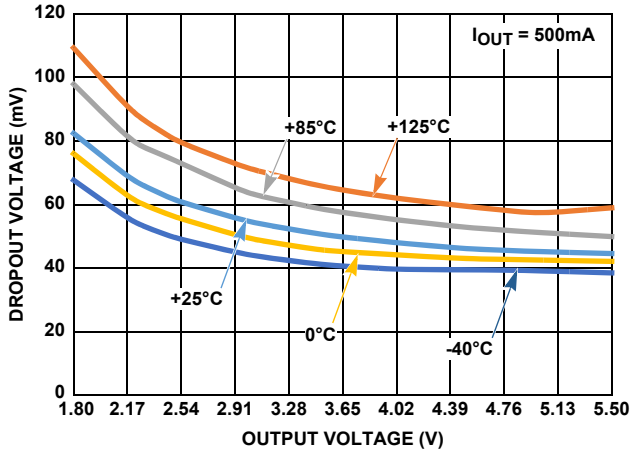

FIGURE 6. DROPOUT vs OUTPUT VOLTAGE

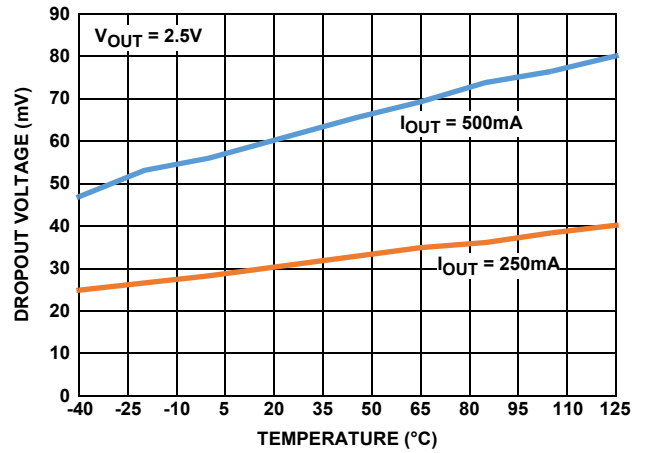

FIGURE 7. DROPOUT vs TEMPERATURE

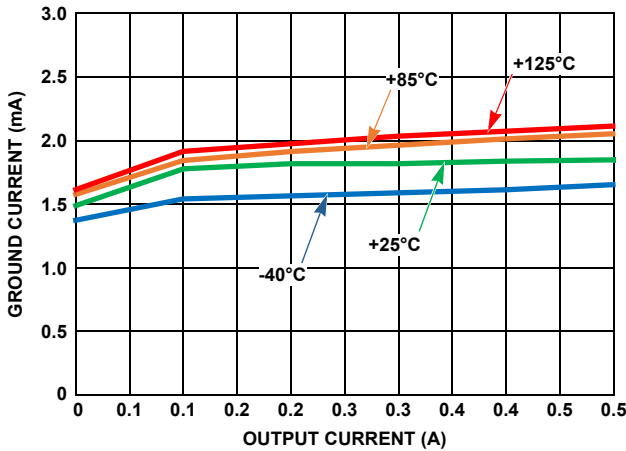

FIGURE 8. GROUND CURRENT vs OUTPUT CURRENT

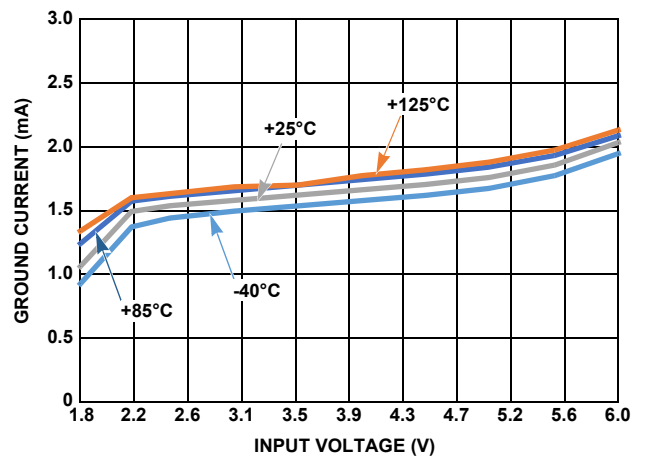

FIGURE 9. GROUND CURRENT vs INPUT VOLTAGE

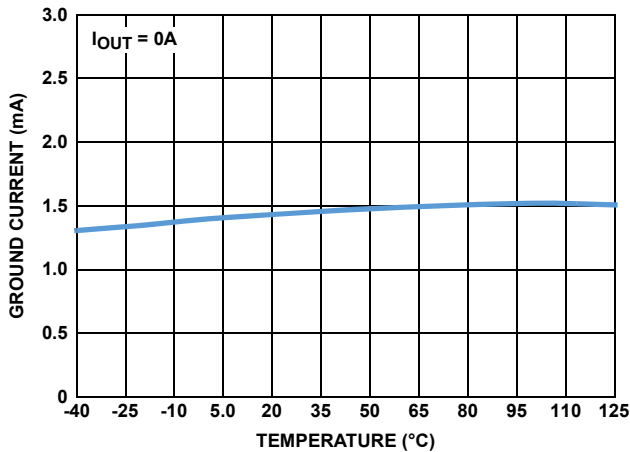

FIGURE 10. GROUND CURRENT vs TEMPERATURE

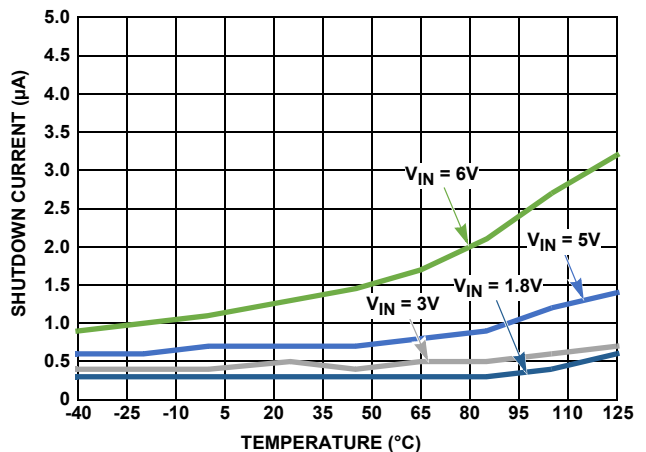

FIGURE 11. SHUTDOWN CURRENT vs TEMPERATURE

Typical Operating Performance

Unless otherwise noted: $V_{IN} = 2.2V$, $V_{OUT} = 1.8V$, $C_{IN} = C_{OUT} = 10\mu F$, $T_J = +25^\circ C$, $I_{LOAD} = 0A$. (Continued)

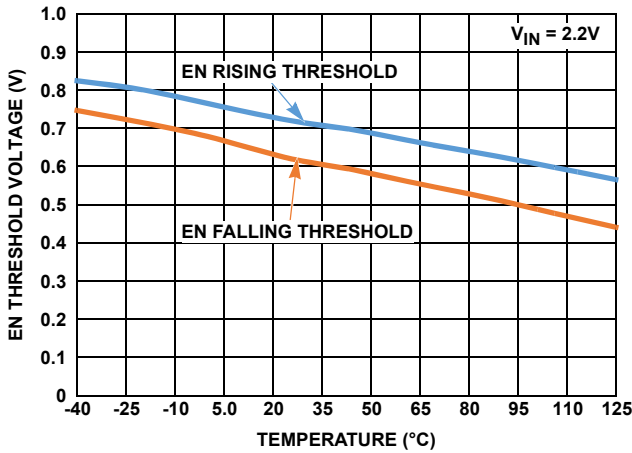

FIGURE 12. EN THRESHOLDS vs TEMPERATURE

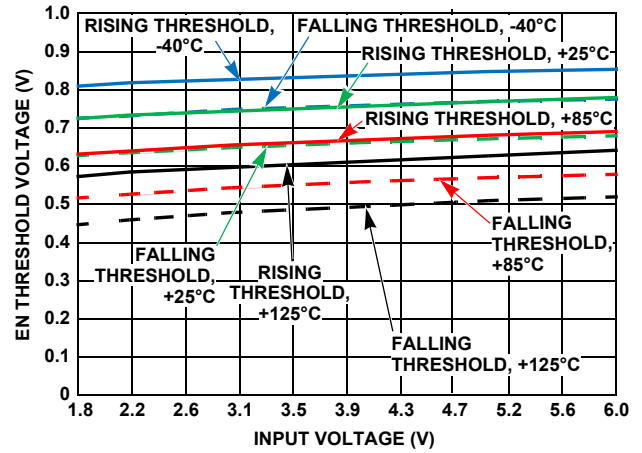

FIGURE 13. EN THRESHOLDS vs INPUT VOLTAGE

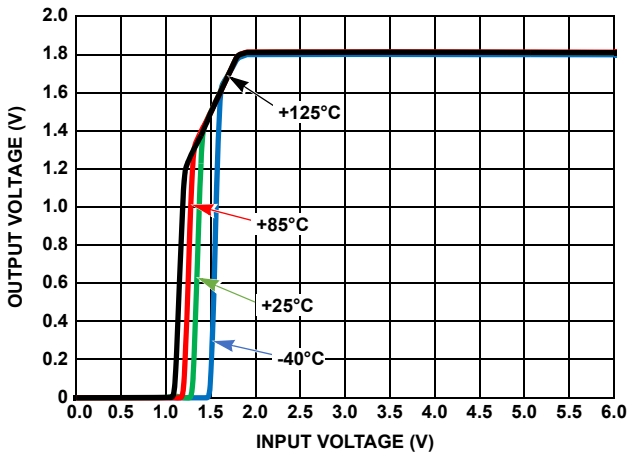

FIGURE 14. OUTPUT VOLTAGE vs INPUT VOLTAGE

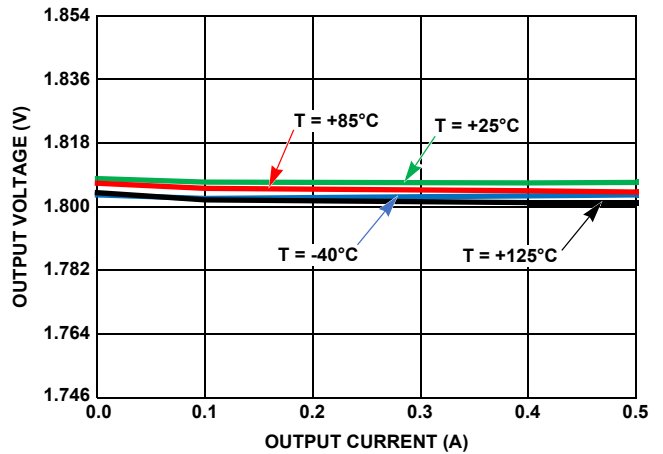

FIGURE 15. OUTPUT VOLTAGE vs OUTPUT CURRENT

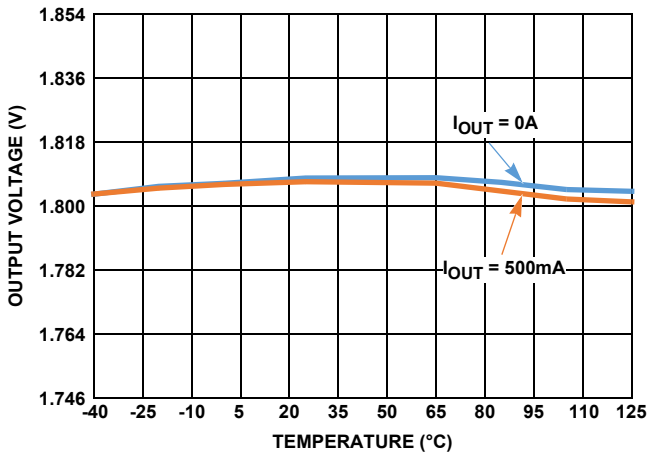

FIGURE 16. OUTPUT VOLTAGE vs TEMPERATURE

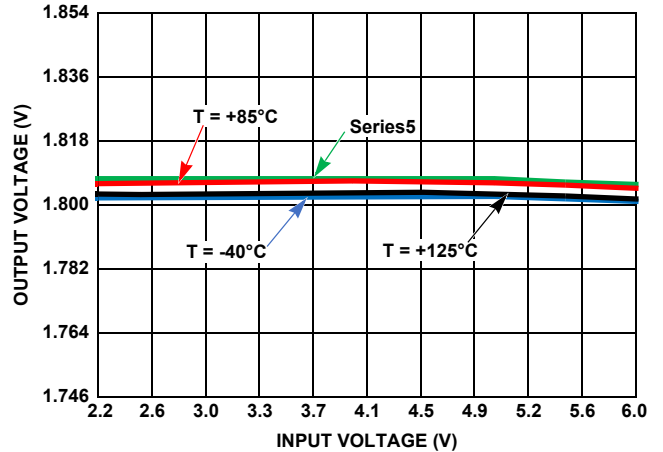

FIGURE 17. OUTPUT VOLTAGE vs INPUT VOLTAGE

Typical Operating Performance

Unless otherwise noted: $V_{IN} = 2.2V$, $V_{OUT} = 1.8V$, $C_{IN} = C_{OUT} = 10\mu F$, $T_J = +25^\circ C$, $I_{LOAD} = 0A$. (Continued)

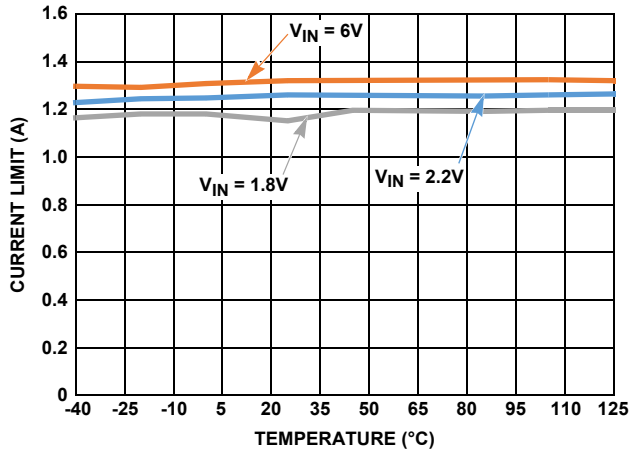

FIGURE 18. CURRENT LIMIT vs TEMPERATURE

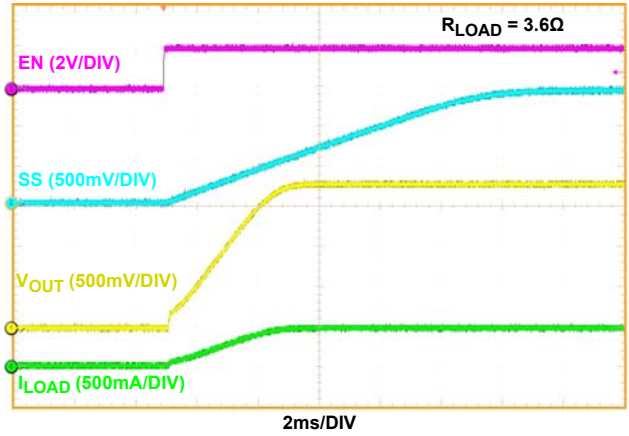

FIGURE 19. ENABLE START-UP ($C_{SS} = 10nF$)

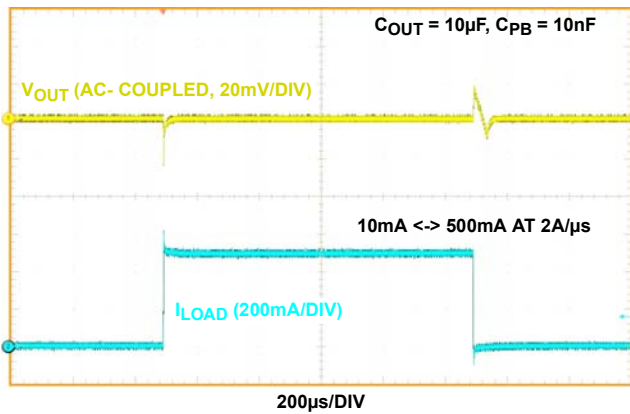

FIGURE 20. LOAD TRANSIENT RESPONSE

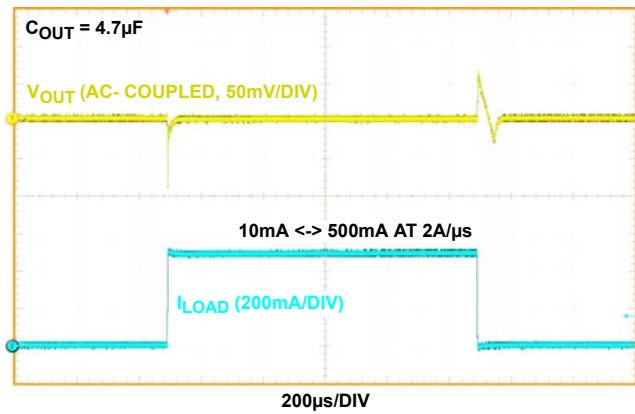

FIGURE 21. LOAD TRANSIENT RESPONSE

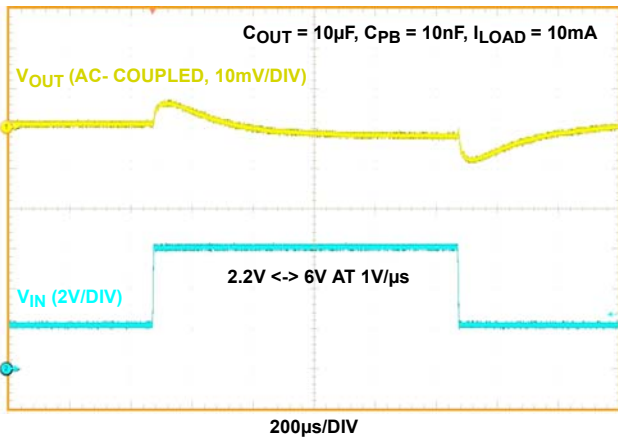

FIGURE 22. LINE TRANSIENT RESPONSE

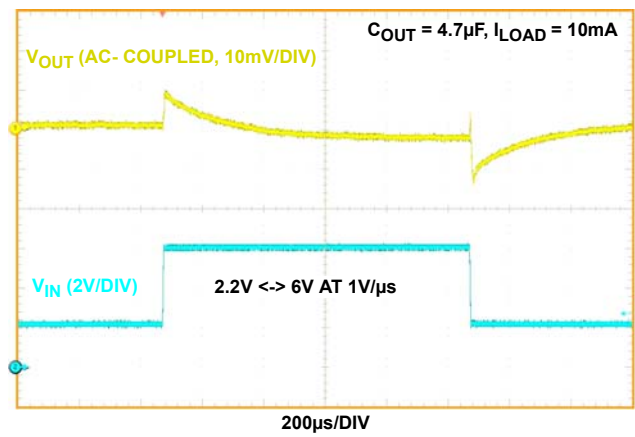

FIGURE 23. LINE TRANSIENT RESPONSE

Typical Operating Performance

Unless otherwise noted: $V_{IN} = 2.2V$, $V_{OUT} = 1.8V$, $C_{IN} = C_{OUT} = 10\mu F$,
 $T_j = +25^\circ C$, $I_{LOAD} = 0A$. (Continued)

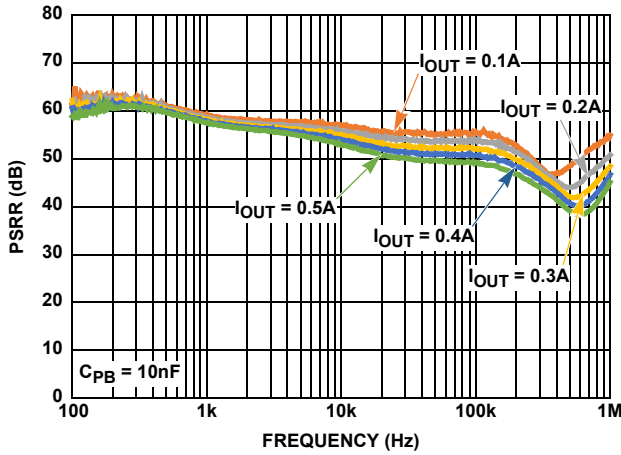

FIGURE 24. PSRR vs FREQUENCY

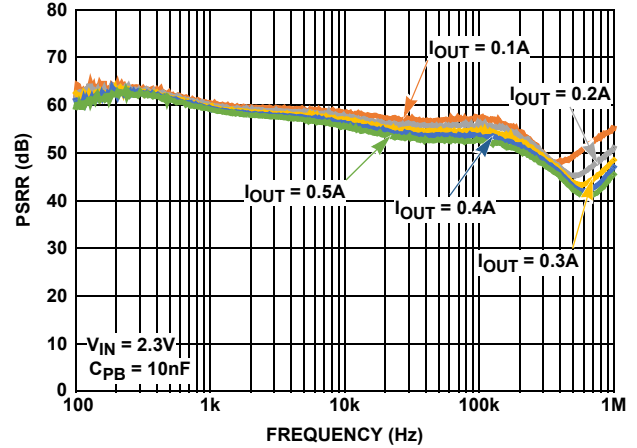

FIGURE 25. PSRR vs FREQUENCY

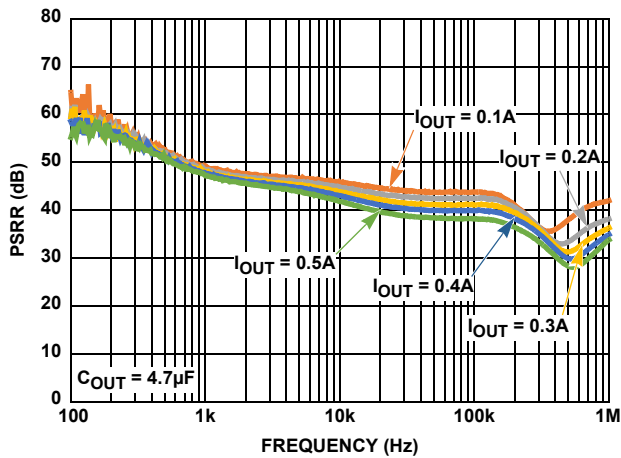

FIGURE 26. PSRR vs FREQUENCY ($C_{OUT} = 4.7\mu F$)

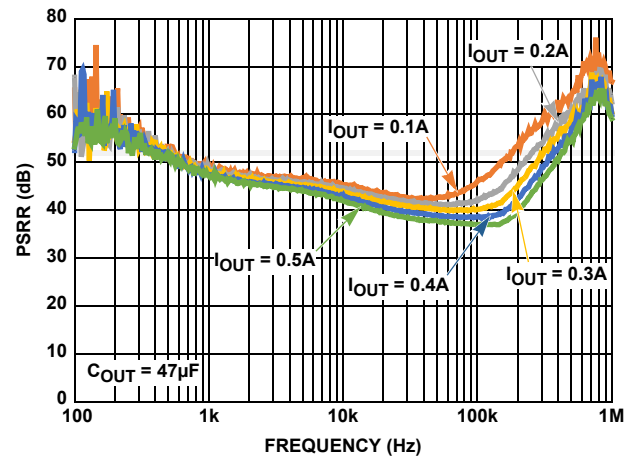

FIGURE 27. PSRR vs FREQUENCY ($C_{OUT} = 47\mu F$)

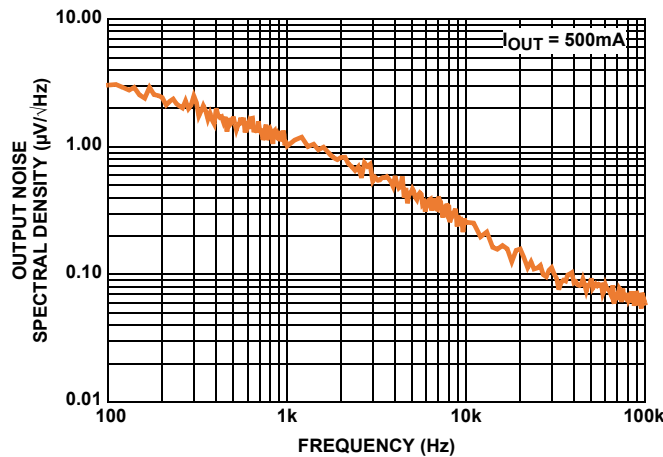

FIGURE 28. OUTPUT NOISE SPECTRAL DENSITY

Applications Information

Input Voltage Requirements

The ISL80505 is a linear voltage regulator operating from 1.8V to 6V input voltage and regulates output voltage between 0.8V to 5.5V, a maximum 500mA output current.

Due to the nature of an LDO, V_{IN} must be some margin higher than V_{OUT} plus dropout at the maximum rated current of the application if active filtering (PSRR) is expected from V_{IN} to V_{OUT} . The generous dropout specification of this family of LDOs allows applications to design a level of efficiency.

Enable Operation

The ENABLE turn-on threshold is typically 800mV with 80mV of hysteresis. An internal pull-up or pull-down resistor to change these values is available upon request. As a result, this pin must not be left floating and should be tied to V_{IN} if not used. A 1k Ω to 10k Ω pull-up resistor is required for applications that use open collector or open-drain outputs to control the ENABLE pin. The ENABLE pin may be connected directly to V_{IN} for applications with outputs that are always on.

Output Voltage

The output voltage can be set by an external resistor divider network. The values of resistors R_1 and R_2 can be calculated by using [Equation 1](#).

$$R_1 = R_2 \times \left(\frac{V_{OUT}}{0.5} - 1 \right) \quad (\text{EQ. 1})$$

Soft-Start Operation

The soft-start circuit controls the rate at which the output voltage rises up to regulation at power-up or LDO enable. This start-up ramp time can be set by adding an external capacitor from the SS pin to ground. An internal 2 μ A current source charges up the C_{SS} and the feedback reference voltage is clamped to the voltage across it. The start-up time is set by [Equation 2](#).

$$t_{\text{start}} = \frac{C_{SS} \times 0.5}{2\mu\text{A}} \quad (\text{EQ. 2})$$

[Equation 3](#) determines the C_{SS} required for a specific start-up inrush current, where V_{OUT} is the output voltage, C_{OUT} is the total capacitance on the output and I_{INRUSH} is the desired inrush current.

$$C_{SS} = \frac{V_{OUT} \times C_{OUT} \times 2\mu\text{A}}{I_{INRUSH} \times 0.5\text{V}} \quad (\text{EQ. 3})$$

The external capacitor is always discharged to ground at the beginning of start-up or enabling.

External Capacitor Requirements

External capacitors are required for proper operation. Careful attention must be paid to the layout guidelines and selection of capacitor type and value to ensure optimal performance.

OUTPUT CAPACITOR

The ISL80505 applies state-of-the-art internal compensation to keep the selection of the output capacitor simple for the

customer. Stable operation over full temperature, V_{IN} range, V_{OUT} range, and load extremes are guaranteed for all capacitor types and values assuming a minimum of 4.7 μ F X5R/X7R is used for local bypass on V_{OUT} . This output capacitor must be connected to the V_{OUT} and GND pins of the LDO with PCB traces no longer than 0.5cm.

There is a growing trend to use very low ESR Multilayer Ceramic Capacitors (MLCC) because they can support fast load transients and also bypass very high frequency noise from other sources. However, the effective capacitance of MLCCs drops with applied voltage, age, and temperature. X7R and X5R dielectric ceramic capacitors are strongly recommended as they typically maintain a capacitance range within $\pm 20\%$ of nominal voltage over full operating ratings of temperature and voltage.

Additional capacitors of any value in ceramic, POSCAP, alum/tantalum electrolytic types may be placed in parallel to improve PSRR at higher frequencies and/or load transient AC output voltage tolerances.

INPUT CAPACITOR

For proper operation, a minimum capacitance of 4.7 μ F X5R/X7R is required at the input. This ceramic input capacitor must be connected to the V_{IN} and GND pins of the LDO with PCB traces no longer than 0.5cm.

PHASE BOOST CAPACITOR (CPB)

A small phase boost capacitor, C_{PB} , can be placed across the top resistor, R_1 , in the feedback resistor divider network in order to improve the AC performances of the LDO for the applications where the output capacitor is 10 μ F or larger. For 10 μ F output capacitor, the recommended C_{PB} value can be calculated by using [Equation 4](#).

$$C_{PB} = \frac{1}{2\pi \times 6000 \times R_1} \quad (\text{EQ. 4})$$

This zero increases the crossover frequency of the LDO and provides additional phase resulting in faster load transient response.

Power Dissipation and Thermals

The junction temperature must not exceed the range specified in the ["Recommended Operating Conditions" on page 4](#). The power dissipation can be calculated by using [Equation 5](#):

$$P_D = (V_{IN} - V_{OUT}) \times I_{OUT} + V_{IN} \times I_{GND} \quad (\text{EQ. 5})$$

The maximum allowable junction temperature, $T_{J(MAX)}$ and the maximum expected ambient temperature, $T_{A(MAX)}$, determine the maximum allowable power dissipation, as shown in [Equation 6](#):

$$P_{D(MAX)} = (T_{J(MAX)} - T_A) / \theta_{JA} \quad (\text{EQ. 6})$$

θ_{JA} is the junction-to-ambient thermal resistance.

For safe operation, ensure that the power dissipation P_D , calculated from [Equation 5](#), is less than the maximum allowable power dissipation $P_{D(MAX)}$.

The DFN package uses the copper area on the PCB as a heatsink. The EPAD of this package must be soldered to the copper plane (GND plane) for effective heat dissipation. Figure 29 shows a curve for the θ_{JA} of the DFN package for different copper area sizes.

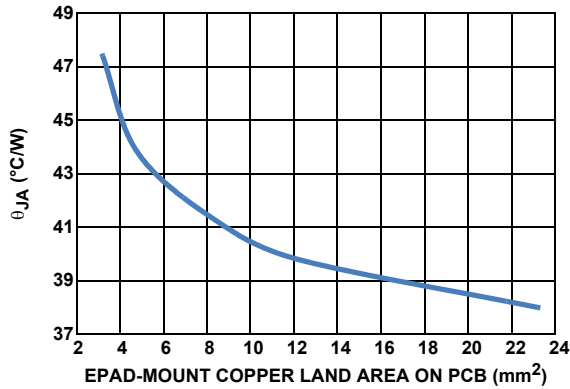

FIGURE 29. 3mmx3mm-10 PIN DFN ON 4-LAYER PCB WITH THERMAL VIAS θ_{JA} vs EPAD-MOUNT COPPER LAND AREA ON PCB

Thermal Fault Protection

The power level and the thermal impedance of the package (+48°C/W for DFN) determine when the junction temperature exceeds the thermal shutdown temperature. In the event that the die temperature exceeds around +160°C, the output of the LDO will shut down until the die temperature cools down to about +130°C.

Current Limit Protection

The ISL80505 LDO incorporates protection against overcurrent due to any short or overload condition applied to the output pin. The LDO performs as a constant current source when the output current exceeds the current limit threshold noted in the “Electrical Specifications” table on page 4. If the short or overload condition is removed from V_{OUT} , then the output returns to normal voltage regulation mode. In the event of an overload condition, the LDO may begin to cycle on and off due to the die temperature exceeding thermal fault condition and subsequently cooling down after the power device is turned off.

PC Board Layout

The performance of this LDO depends greatly on the care taken in designing the PC board. The following are recommendations to achieve optimum performance.

- A minimum capacitance of 4.7µF X5R/X7R ceramic input capacitor must be placed to the V_{IN} and GND pins of the LDO with PCB traces no longer than 0.5cm.
- A minimum capacitance of 4.7µF X5R/X7R ceramic output capacitor must be placed to the V_{OUT} and GND pins of the LDO with PCB traces no longer than 0.5cm.
- Connect the EPAD to the ground plane with low-thermal resistance vias.

Figure 30 shows an example for 2-layer PCB layout. The bottom layer is the ground plane.

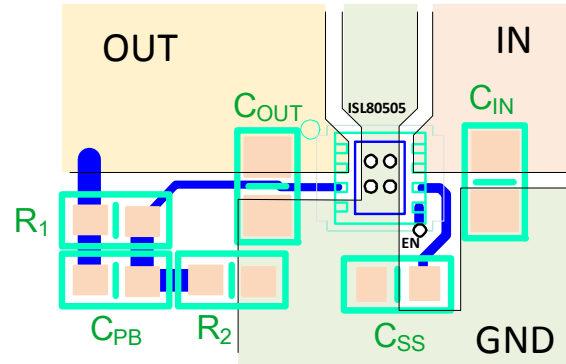

FIGURE 30. EXAMPLE FOR PCB LAYOUT

General PowerPAD Design Considerations

The following is an example of how to use vias to remove heat from the IC.

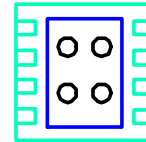

FIGURE 31. PCB VIA PATTERN

A minimum of 4 vias evenly distributed to fill the thermal pad footprint is recommended. Keep the vias small but not so small that their inside diameter prevents solder wicking through the holes during reflow.

Connect all vias to the ground plane. It is important the vias have a low thermal resistance for efficient heat transfer. Do not use “thermal relief” patterns to connect the vias. It is important to have a complete connection of the plated through-hole to each plane.

Revision History The revision history provided is for informational purposes only and is believed to be accurate, but not warranted. Please visit our website to make sure you have the latest revision.

DATE	REVISION	CHANGE
November 10, 2016	FN8770.1	Updated Related Literature section on page 1. Updated Note 1 on page 2.
September 8, 2015	FN8770.0	Initial Release

About Intersil

Intersil Corporation is a leading provider of innovative power management and precision analog solutions. The company's products address some of the largest markets within the industrial and infrastructure, mobile computing, and high-end consumer markets.

For the most updated datasheet, application notes, related documentation, and related parts, see the respective product information page found at www.intersil.com.

You may report errors or suggestions for improving this datasheet by visiting www.intersil.com/ask.

Reliability reports are also available from our website at www.intersil.com/support.

© Copyright Intersil Americas LLC 2015-2016. All Rights Reserved.
All trademarks and registered trademarks are the property of their respective owners.

For additional products, see www.intersil.com/en/products.html

Intersil products are manufactured, assembled and tested utilizing ISO9001 quality systems as noted in the quality certifications found at www.intersil.com/en/support/qualandreliability.html

Intersil products are sold by description only. Intersil may modify the circuit design and/or specifications of products at any time without notice, provided that such modification does not, in Intersil's sole judgment, affect the form, fit or function of the product. Accordingly, the reader is cautioned to verify that datasheets are current before placing orders. Information furnished by Intersil is believed to be accurate and reliable. However, no responsibility is assumed by Intersil or its subsidiaries for its use; nor for any infringements of patents or other rights of third parties which may result from its use. No license is granted by implication or otherwise under any patent or patent rights of Intersil or its subsidiaries.

For information regarding Intersil Corporation and its products, see www.intersil.com

Package Outline Drawing

For the most recent package outline drawing, see [L8.3x3J](#).

L8.3x3J

8 LEAD DUAL FLAT NO-LEAD PLASTIC PACKAGE

Rev 1.3/15

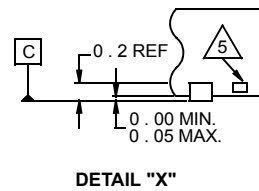
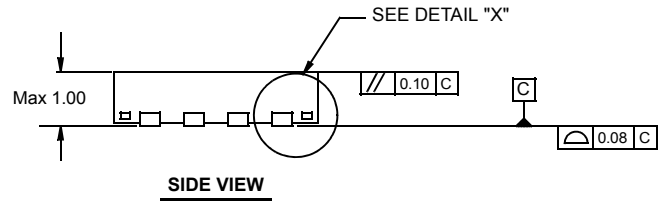
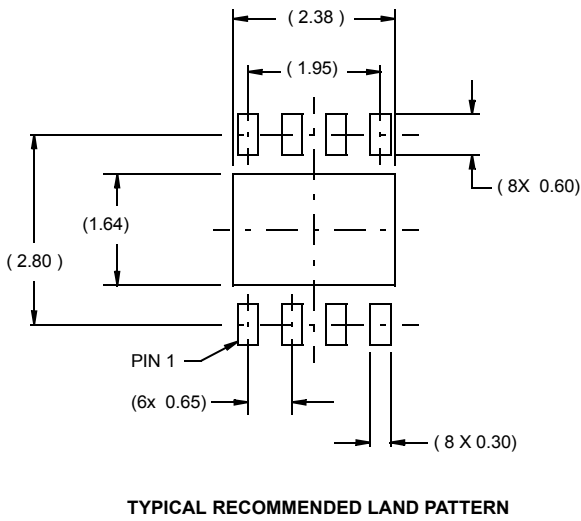
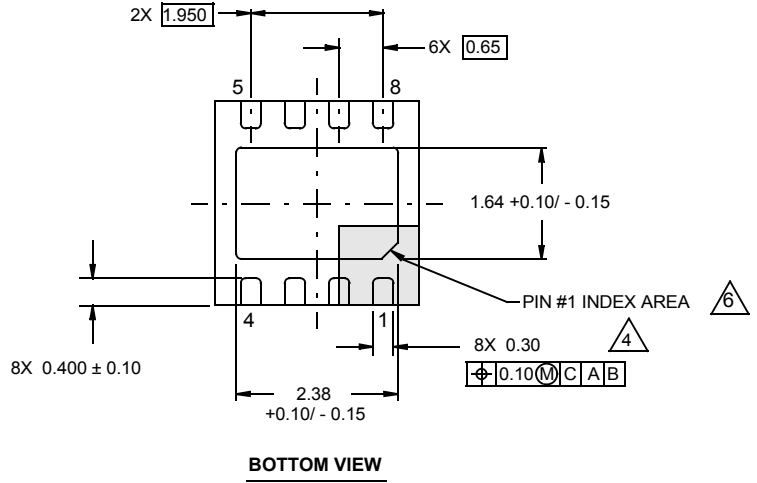
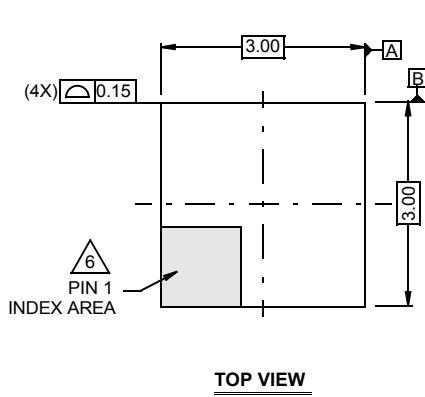

NOTES:

1. Dimensions are in millimeters.
Dimensions in () for Reference Only.
2. Dimensioning and tolerancing conform to AMSE Y14.5m-1994.
3. Unless otherwise specified, tolerance : Decimal ± 0.05
4. Dimension applies to the metallized terminal and is measured between 0.15mm and 0.30mm from the terminal tip.
5. Tiebar shown (if present) is a non-functional feature and may be located on any of the 4 sides (or ends).
6. The configuration of the pin #1 identifier is optional, but must be located within the zone indicated. The pin #1 identifier may be either a mold or mark feature.