

ISL70591SEH, ISL70592SEH, ISL73591SEH, ISL73592SEH

Radiation Hardened 100µA and 1mA Precision Current Sources

FN9335

Rev.0.00

Aug 30, 2018

The [ISL70591SEH](#), [ISL73591SEH](#), [ISL70592SEH](#), and [ISL73592SEH](#) are radiation hardened precision 100µA and 1mA current source ICs. The devices have excellent accuracy of ±1% over a wide operating voltage range of 3V to 40V and over a temperature range of -55°C to +125°C. Fabricated with the Renesas proprietary PR40 Silicon On Insulator (SOI) process, the devices are immune to single event latch-up.

The high output impedance of the devices make them insensitive to the voltage drops across long lines. They can withstand a forward operating voltage of 40V and a reverse voltage of -0.5V.

The ISL7x591SEH and ISL7x592SEH are two terminal floating current sources and that allows them to be used in high side, low side, and dual side load applications such as sensor excitation, biasing networks, low voltage references, floating voltage references, and ramp generators. The current sources were primarily designed for thermistor and other sensor excitation applications widely used in space crafts.

The ISL7x591SEH and ISL7x592SEH are available in a 4 Ld ceramic flatpack and die forms. The temperature range is -55°C to +125°C.

Applications

- Sensor excitation
- Biasing network
- Low voltage references
- Ramp generators

Features

- Electrically screened to DLA SMD [5962-18217](#)
- Wide operating voltage range: 3V to 40V
- High initial accuracy (+V = 20V at +25°C):
 - ISL7x591SEH: ±0.34%
 - ISL7x592SEH: ±0.30%
- High output impedance:
 - ISL7x591SEH: 189MΩ (typical)
 - ISL7x592SEH: 14MΩ (typical)
- Completely floating: No ground connection
- Radiation acceptance testing - ISL70591SEH and ISL70592SEH
 - High dose rate (50-300rad(Si)/s): 100krad(Si)
 - Low dose rate (0.01rad(Si)/s): 75krad(Si)
- Radiation acceptance testing - ISL73591SEH and ISL73592SEH
 - Low dose rate (0.01rad(Si)/s): 75krad(Si)
- SEE hardness
 - No SEB/SEL LET_{TH}, +V = 35V: 86MeV•cm²/mg
 - SET duration (time recovery) ≤125µs

Related Literature

For a full list of related documents, visit our website:

- [ISL70591SEH](#), [ISL70592SEH](#), [ISL73591SEH](#), and [ISL73592SEH](#) product pages.

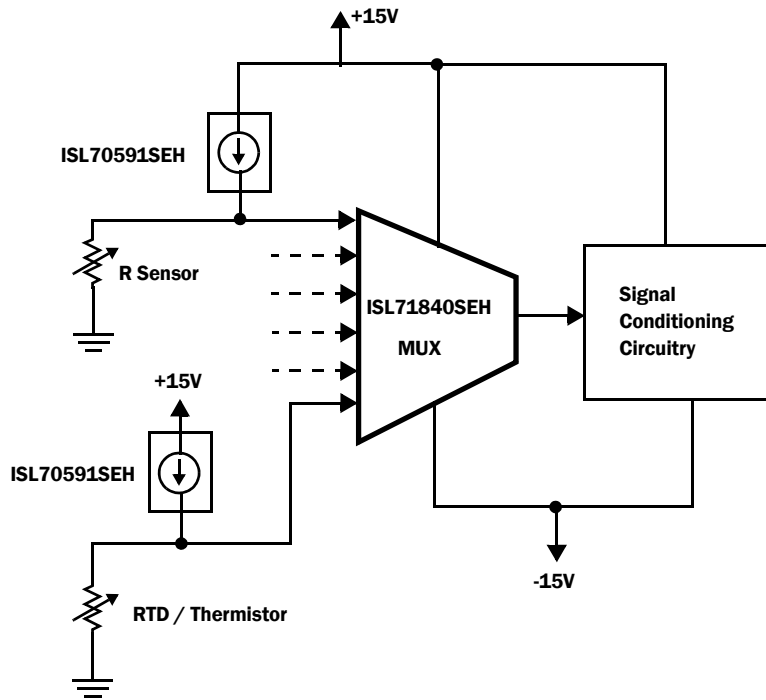

Figure 1. Typical Application

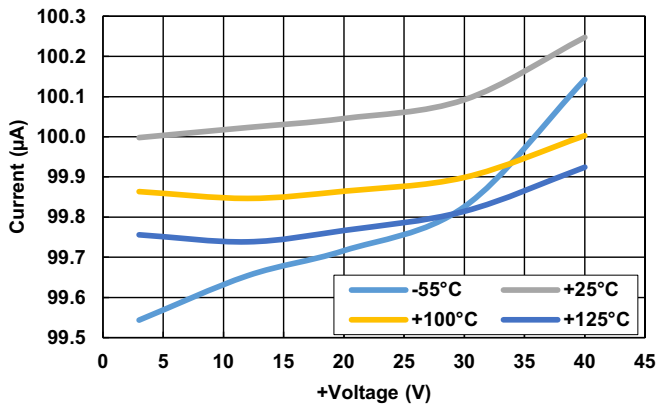

Figure 2. Output Current vs +V Voltage vs Temperature for the ISL7X591SEH

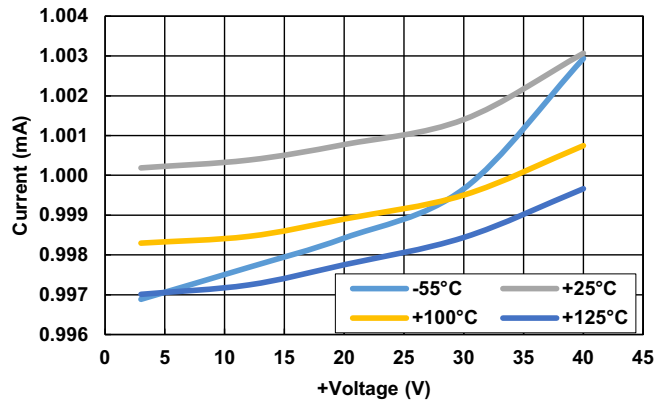

Figure 3. Output Current vs +V Voltage vs Temperature for the ISL7X592SEH

Contents

1. Overview	4
1.1 Block Diagram	4
1.2 Ordering Information	4
1.3 Pin Configurations	5
1.4 Pin Descriptions	5
1.5 Typical Application Schematics	6
2. Specifications	7
2.1 Absolute Maximum Ratings	7
2.2 Thermal Information	7
2.3 Recommended Operating Conditions	7
2.4 Electrical Specifications	8
2.5 Test Circuits and Waveforms	10
3. Typical Performance Curves	11
4. Applications Information	17
4.1 Functional Description	17
4.2 Temperature Coefficient	17
4.3 Floating Current Source Topology	17
4.4 Power Supply Recommendations	17
4.5 Connecting Multiple Current Sources in Parallel for Higher Drive Current	18
4.6 Circuit Considerations	18
5. Die Characteristics	19
6. Metallization Mask Layout	20
7. Revision History	21
8. Package Outline Drawing	22

1. Overview

1.1 Block Diagram

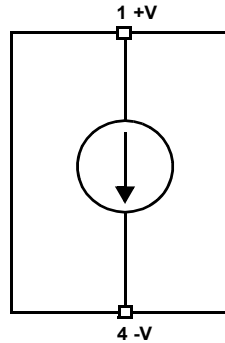

Figure 4. Block Diagram

1.2 Ordering Information

Ordering / SMD Number (Note 1)	Part Number (Note 2)	Temperature Range (°C)	Package (RoHS Compliant)	Package Drawing
5962R1821701VXC	ISL70591SEHVF	-55 to +125	4 Ld Ceramic Flatpack	K4.A
5962R1821701V9A	ISL70591SEHVX	-55 to +125	Die	
5962L1821702VXC	ISL73591SEHVF	-55 to +125	4 Ld Ceramic Flatpack	K4.A
5962L1821702V9A	ISL73591SEHVX	-55 to +125	Die	
N/A	ISL73591SEHF/PROTO, (Note 3)	-55 to +125	4 Ld Ceramic Flatpack	K4.A
N/A	ISL70591SEHF/PROTO, (Note 3)	-55 to +125	4 Ld Ceramic Flatpack	K4.A
N/A	ISL70591SEHX/SAMPLE, (Note 3)	+25	Die	
5962R1821703VXC	ISL70592SEHVF	-55 to +125	4 Ld Ceramic Flatpack	K4.A
5962R1821703V9A	ISL70592SEHVX	-55 to +125	Die	
5962L1821704VXC	ISL73592SEHVF	-55 to +125	4 Ld Ceramic Flatpack	K4.A
5962L1821704V9A	ISL73592SEHVX	-55 to +125	Die	
N/A	ISL70592SEHF/PROTO, (Note 3)	-55 to +125	4 Ld Ceramic Flatpack	K4.A
N/A	ISL70592SEHX/SAMPLE, (Note 3)	+25	Die	
N/A	ISL73592SEHF/PROTO, (Note 3)	-55 to +125	4 Ld Ceramic Flatpack	K4.A
N/A	ISL70591SEHEVAL1Z, (Note 4)	Evaluation Board		
N/A	ISL70592SEHEVAL1Z, (Note 4)	Evaluation Board		

Notes:

- Specifications for Rad Hard QML devices are controlled by the Defense Logistics Agency Land and Maritime (DLA). The SMD numbers must be used when ordering.
- These Pb-free Hermetic packaged products employ 100% Au plate - e4 termination finish, which is RoHS compliant and compatible with both SnPb and Pb-free soldering operations.
- The /PROTO and /SAMPLE are not rated or certified for Total Ionizing Dose (TID) or Single Event Effect (SEE) immunity. These parts are intended for engineering evaluation purposes only. The /PROTO parts meet the electrical limits and conditions over-temperature specified in the DLA SMD and are in the same form and fit as the qualified device. The /SAMPLE parts are capable of meeting the electrical limits and conditions specified in the DLA SMD at +25°C only. The /SAMPLE parts do not receive 100% screening over-temperature to the DLA SMD electrical limits. These part types do not come with a Certificate of Conformance because they may not have been Radiation Assurance tested and they are not DLA qualified devices.
- Evaluation boards use the /PROTO parts and /PROTO parts are not rated or certified for Total Ionizing Dose (TID) or Single Event Effect (SEE) immunity.

Table 1. ISL7x59xSEH Product Family Feature Table

Specification	ISL70591SEH	ISL73591SEH	ISL70592SEH	ISL73592SEH
Output Current	100 μ A	100 μ A	1mA	1mA
Current Temperature Coefficient	2.25nA/ $^{\circ}$ C	2.25nA/ $^{\circ}$ C	19nA/ $^{\circ}$ C	19nA/ $^{\circ}$ C
Output Impedance	189M Ω	189M Ω	14M Ω	14M Ω
HDR 100krad(Si)	Yes	N/A	Yes	N/A
LDR 75krad(Si)	Yes	Yes	Yes	Yes

N/A: Not Applicable

1.3 Pin Configurations

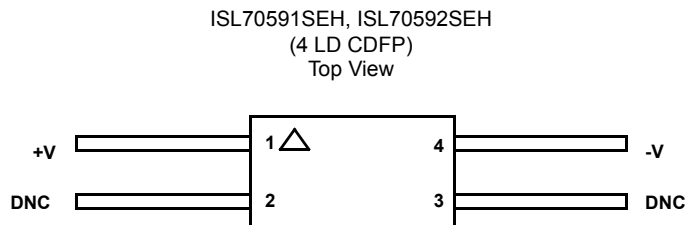

Note: The ESD triangular mark is indicative of Pin 1. It is a part of the device marking and is placed on the lid in the quadrant where Pin 1 is located.

1.4 Pin Descriptions

Pin Number	Pin Name	ESD Circuit	Description
1	+V	1	Positive voltage lead, range 3V to 40V with respect to -V.
2	DNC		DNC (Do Not Connect) = OPEN (Float). Internally connected.
3	DNC		DNC (Do Not Connect) = OPEN (Float). Internally connected.
4	-V		Negative voltage lead.
-	Package Lid	-	Internally connected to -V (Pin 4).

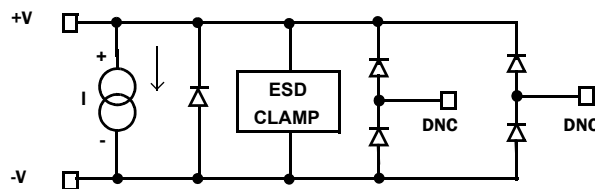
**Figure 5. ESD Circuit 1**

1.5 Typical Application Schematics

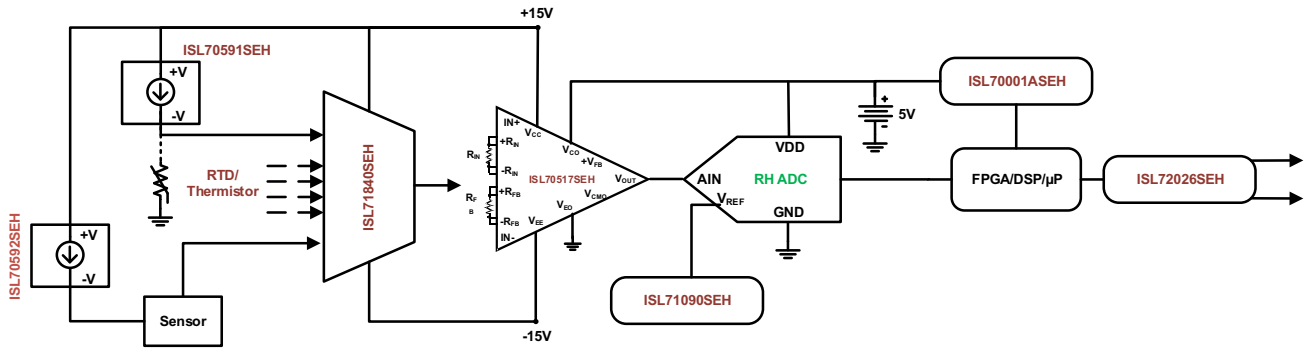

Figure 6. Sensor Signal Conditioning and Data Acquisition Application

2. Specifications

2.1 Absolute Maximum Ratings

Parameter	Minimum	Maximum	Unit
Maximum Supply Voltage		+42	V
In-Beam Maximum Supply Voltage (Note 5)		+35	V
Maximum Reverse Voltage		-0.5	V
ESD Rating	Value		Unit
Human Body Model (Tested per MIL-STD-883 TM3015.7)	7		kV
Charged Device Model (Tested per JS-002-2014)	750		V

Note:

5. The maximum supply voltage specified is for operation in a heavy ion environment at an LET = 86.4 MeV·cm²/mg and +125°C case temperature. Refer to single event effects [test report](#) for more information.

CAUTION: Do not operate at or near the maximum ratings listed for extended periods of time. Exposure to such conditions may adversely impact product reliability and result in failures not covered by warranty.

2.2 Thermal Information

Thermal Resistance (Typical)	θ_{JA} (°C/W)	θ_{JC} (°C/W)
4 Ld CFP Package (Notes 6, 8)	173	11
4 Ld CFP Package (Notes 7, 8)	53	11

Notes:

6. θ_{JA} is measured with the component mounted on a high-effective thermal conductivity test board (2 buried 1oz planes). Air GAP between Pkg and PCB. See [TB379](#).
7. θ_{JA} is measured with the component mounted on a high-effective thermal conductivity test board with direct attach features (2 buried 1oz planes, thermal land under pkg with 16 vias touching 1 of the buried planes). Pkg base mounted to PCB thermal land with 0.25mm (~ 10mil) thick adhesive material with "k" of 1 W/m-K.
8. For θ_{JC} , the "case temp" location is the center of the package underside.

Parameter	Minimum	Maximum	Unit
Maximum Junction Temperature		+150	°C
Storage Temperature Range	-65	+150	°C

2.3 Recommended Operating Conditions

Parameter	Minimum	Maximum	Unit
Ambient Temperature	-55	+125	°C
Supply Voltage	3	40	V
Supply Voltage under Ion Beam	3	35	V

2.4 Electrical Specifications

Recommended operating conditions, +V = 20V, T_A = +25° unless otherwise specified.

Parameter	Symbol	Test Conditions	Temperature	Min (Note 10)	Typ (Note 9)	Max (Note 10)	Unit
ISL70591SEH, ISL730591SEH (100µA) Current Source Specifications							
Input Voltage Range	+V		-55°C to +125°C	3	-	40	V
Output Current at 40V	IO _{40V}	+V = 40V	-55°C	99.39	100.08	100.78	µA
			+25°C	99.79	100.24	100.69	
			+125°C	99.33	99.90	100.47	
		+V = 40V, Post Rad	+25°C - Post Rad	99.44	100.13	100.80	
Output Current at 30V	IO _{30V}	+V = 30V	-55°C	99.22	99.78	100.34	µA
			+25°C	99.75	100.09	100.43	
			+125°C	99.39	99.80	100.23	
		+V = 30V, Post Rad	+25°C - Post Rad	99.29	99.90	100.57	
Output Current at 20V	IO _{20V}	+V = 20V	-55°C	99.12	99.67	100.23	µA
			+25°C	99.71	100.05	100.38	
			+125°C	99.39	99.76	100.16	
		+V = 20V, Post Rad	+25°C - Post Rad	99.23	99.86	100.53	
Output Current at 12V	IO _{12V}	+V = 12V	-55°C	99.04	99.61	100.18	µA
			+25°C	99.67	100.03	100.38	
			+125°C	99.35	99.73	100.15	
		+V = 12V, Post Rad	+25°C - Post Rad	99.16	99.83	100.54	
Output Current at 3V	IO _{3V}	+V = 3V	-55°C	98.88	99.50	100.12	µA
			+25°C	99.58	100.00	100.42	
			+125°C	99.26	99.75	100.26	
		+V = 3V, Post Rad	+25°C - Post Rad	99.03	99.80	100.58	
Output Current Temperature Coefficient	I _{OTC}	Note 11	-55°C to +125°C	-	2.25	-	nA/°C
Output Impedance	R _{OUT}	+V = 3V to 40V, Five Point Box Method, Points: 3V, 12V, 20V, 30V, and 40V. Inverse of (I _{max} - I _{min}) / Voltage Range.	-55°C to +125°C	40	189	-	MΩ
			+25°C - Post Rad	40	189	-	
Noise Current Density	i _n	f = 100Hz	+25°C	-	57	-	pA/√Hz
Effective Shunt Capacitance	C _S	f = 1MHz, V _{BIAS} = 20V, LCR meter across the current source pins to measure the capacitance.	+25°C	-	24	-	pF

Recommended operating conditions, +V = 20V, T_A = +25° unless otherwise specified. (Continued)

Parameter	Symbol	Test Conditions	Temperature	Min (Note 10)	Typ (Note 9)	Max (Note 10)	Unit
Turn-On Time	t _{ON}	+V = 0V to 3.1V with a 3.1V/10μs ramp, R _L = 1kΩ, Measure from 10% of +V to when V _{OUT} has settled to within 0.5% of V _{OUT} final value of 100mV. See Figure 7 and 8 .	-55°C to +125°C	-	117	260	μs
			+25°C - Post Rad	-	117	260	
		+V = 0V to 40V with a 40V/100μs ramp, R _L = 1kΩ, Measure from 10% of +V to when V _{OUT} has settled to within 0.5% of V _{OUT} final value 100mV. See Figure 7 and 8 .	-55°C to +125°C	-	100	190	
			+25°C - Post Rad	-	100	190	

Recommended operating conditions, +V = 20V, T_A = +25° unless otherwise specified.

Parameter	Symbol	Test Conditions	Temperature	Min (Note 10)	Typ (Note 9)	Max (Note 10)	Unit
ISL70592SEH, ISL73592SEH (1mA) Current Source Specifications							
Input Voltage Range	+V		-55°C to +125°C	3	-	40	V
Output Current at 40V	IO _{40V}	+V = 40V	-55°C	0.9957	1.0028	1.0100	mA
			+25°C	0.9994	1.0039	1.0078	
			+125°C	0.9944	1.0005	1.0066	
		+V = 40V, Post Rad	+25°C - Post Rad	0.9990	1.0051	1.0110	
Output Current at 30V	IO _{30V}	+V = 30V	-55°C	0.9933	0.9992	1.0051	mA
			+25°C	0.9986	1.0019	1.0052	
			+125°C	0.9945	0.9988	1.0031	
		+V = 30V, Post Rad	+25°C - Post Rad	0.9950	1.0020	1.0080	
Output Current at 20V	IO _{20V}	+V = 20V	-55°C	0.9919	0.9979	1.0038	mA
			+25°C	0.9980	1.0010	1.0040	
			+125°C	0.9940	0.9978	1.0019	
		+V = 20V, Post Rad	+25°C - Post Rad	0.9940	1.000	1.0070	
Output Current at 12V	IO _{12V}	+V = 12V	-55°C	0.9910	0.9971	1.0032	mA
			+25°C	0.9972	1.0004	1.0036	
			+125°C	0.9929	0.9970	1.0012	
		+V = 12V, Post Rad	+25°C - Post Rad	0.9930	0.9997	1.0070	
Output Current	IO _{3V}	+V = 3V	-55°C	0.9897	0.9962	1.0027	mA
			+25°C	0.9960	0.9999	1.0039	
			+125°C	0.9914	0.9965	1.0016	
		+V = 3V, Post Rad	+25°C - Post Rad	0.9910	0.9989	1.0070	
Output Current Temperature Coefficient	I _{OTC}	Note 11	-55°C to +125°C	-	19	-	nA/°C

Recommended operating conditions, +V = 20V, T_A = +25° unless otherwise specified. (Continued)

Parameter	Symbol	Test Conditions	Temperature	Min (Note 10)	Typ (Note 9)	Max (Note 10)	Unit
Output Impedance	R _{OUT}	+V = 3V to 40V, Five Point Box Method, Points: 3V, 12V, 20V, 30V, and 40V. Inverse of (I _{max} - I _{min}) / Voltage Range	-55°C to +125°C	4	14	-	MΩ
			+25°C - Post Rad	4	14	-	
Noise Current Density	i _n	f = 100Hz	+25°C	-	724	-	pA/√Hz
Effective Shunt Capacitance	C _S	f = 1MHz, V _{BIAS} = 20, LCR meter across the current source pins to measure the capacitance	+25°C	-	13	-	pF
Turn-On Time	t _{ON}	+V = 0V to 4V with a 4V/10μs ramp, R _L = 1kΩ, Measure from 10% of +V to when V _{OUT} has settled to within 0.5% of V _{OUT} final value of 1V. See Figure 7 and 8 .	-55°C to +125°C	-	111	230	μs
			+25°C - Post Rad	-	111	230	
		+V = 0V to 40V with a 40V/100μs ramp, R _L = 1kΩ, Measure from 10% of +V to when V _{OUT} has settled to within 0.5% of V _{OUT} final value 1V. See Figure 7 and 8 .	-55°C to +125°C	-	80	170	
			+25°C - Post Rad	-	80	170	

Notes:

9. Typical values shown are not guaranteed.

10. Parameters with MIN and/or MAX limits are 100% tested at -55°C, +25°C and +125°C, unless otherwise specified.

11. Over the specified temperature range. Temperature coefficient is measured by the box method whereby the change in I_{OUT} is divided by the temperature range; in this case, -55°C to +125°C = +180°. See "Application Information" section titled "Temperature Coefficient" for description of box method. T_C (nA/°C) = (I_{OUT} (max) - I_{OUT} (min)) / (T_{HIGH} - T_{LOW}). T_C (ppm/C) = [(I_{OUT} (max) - I_{OUT} (min)) / (T_{HIGH} - T_{LOW}) / Nominal I_{OUT} Current at 25°C] x 10⁶.

2.5 Test Circuits and Waveforms

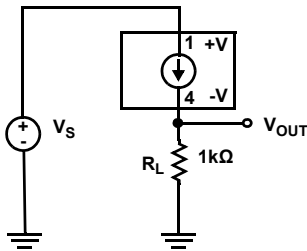

Note: 0V to 40V Ramp Rate 40V/100μs unless otherwise specified.

Figure 7. Electrical Turn-On Time Test Circuit

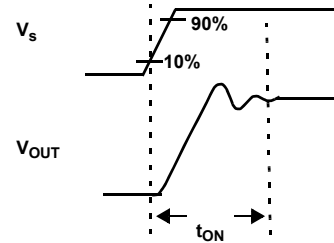

Note: Measure from 10% of V_S to when V_{OUT} has settled to within 0.5% of V_{OUT} final value.

Figure 8. Electrical Turn-On Time Wave Form

3. Typical Performance Curves

ISL7x591SEH 100µA: Unless otherwise noted, +V = 20V; -V = 0V; T_A = +25°C

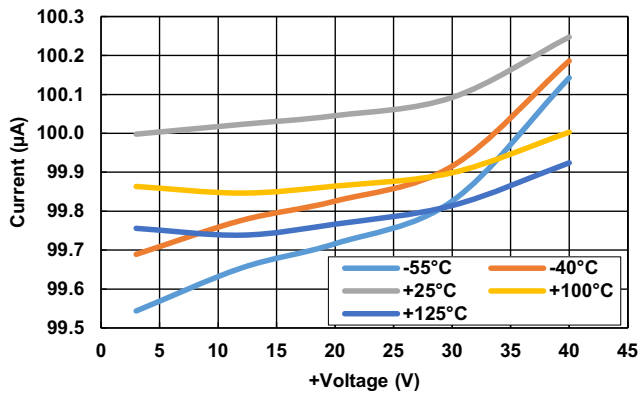

Figure 9. Output Current vs Voltage vs Temperature

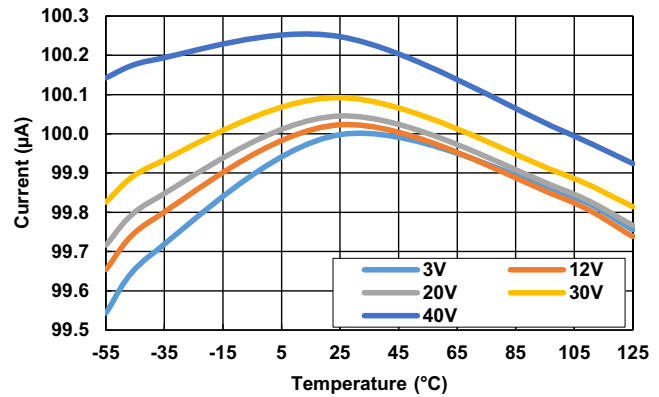

Figure 10. Output Current vs Temperature vs Voltage

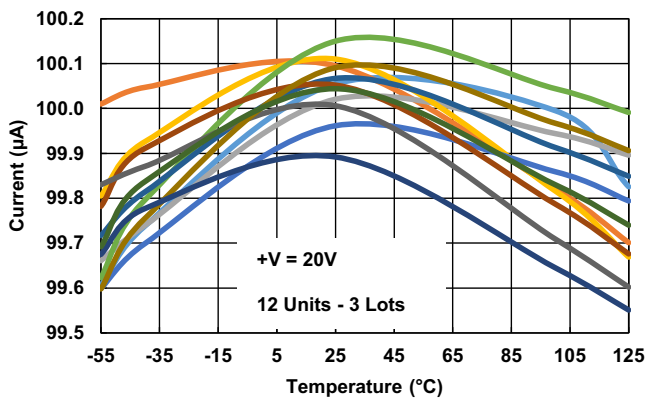
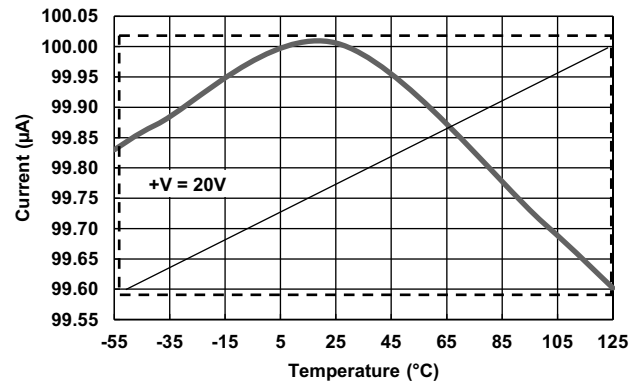

Figure 11. Output Current vs Temperature vs (12 units - 3 lots)



$$100.006\mu\text{A} - 99.602\mu\text{A}/180^\circ\text{C} = 0.404\mu\text{A}/180^\circ\text{C} = 2.25\text{nA}/^\circ\text{C}$$

$$[2.25\text{nA}/^\circ\text{C}/100\mu\text{A}] \times 10^6 = 22.5\text{ppm}/^\circ\text{C}.$$

Figure 12. Typical Temperature Coefficient at +V = 20V

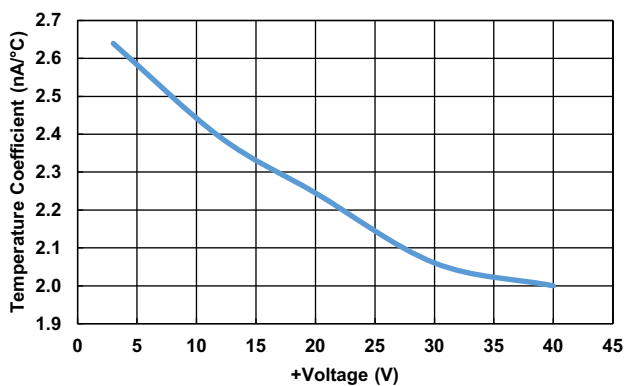

Figure 13. Current Temperature Coefficient vs Voltage

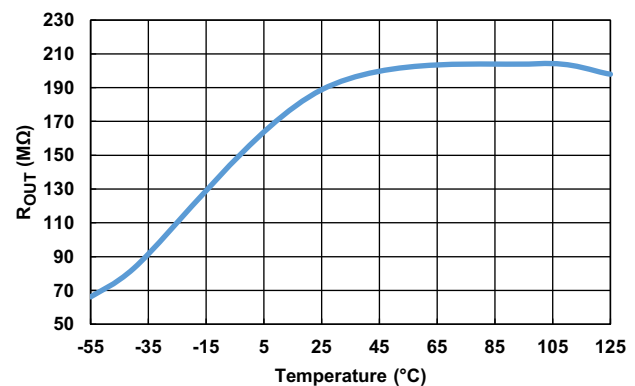

Figure 14. Output Impedance (R_{OUT}) vs Temperature

ISL7x591SEH 100µA: Unless otherwise noted, +V = 20V; -V = 0V; T_A = +25°C (Continued)

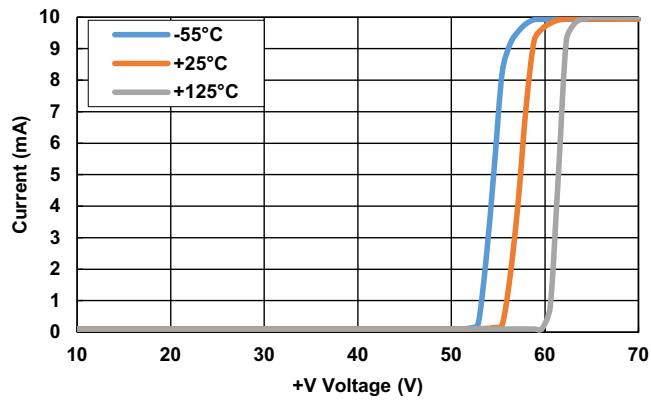

Figure 15. +V Breakdown Voltage

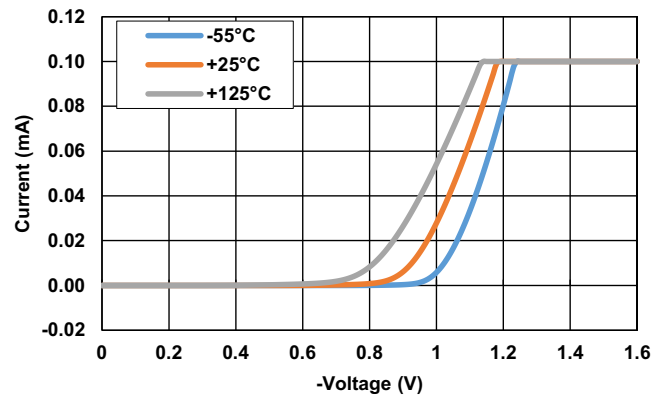

Figure 16. Reverse (-V) Breakdown Voltage

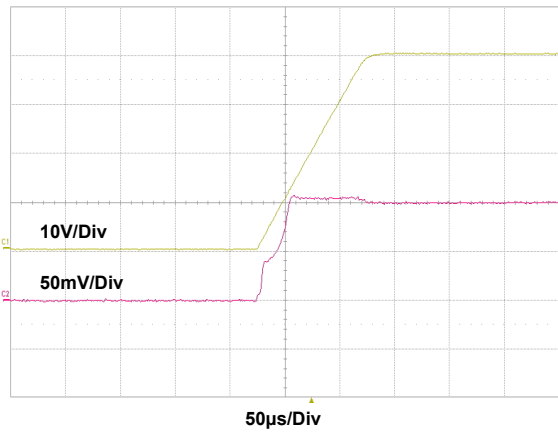

Figure 17. Turn-on Time Plot (40V/100µs Ramp)

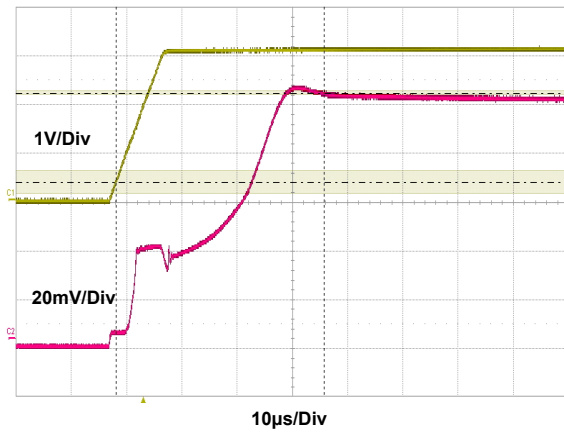

Figure 18. Turn-on Time Plot (3.1V/10µs Ramp)

ISL7x591SEH 100µA: Unless otherwise noted, +V = 20V; -V = 0V; T_A = +25°C (Continued)

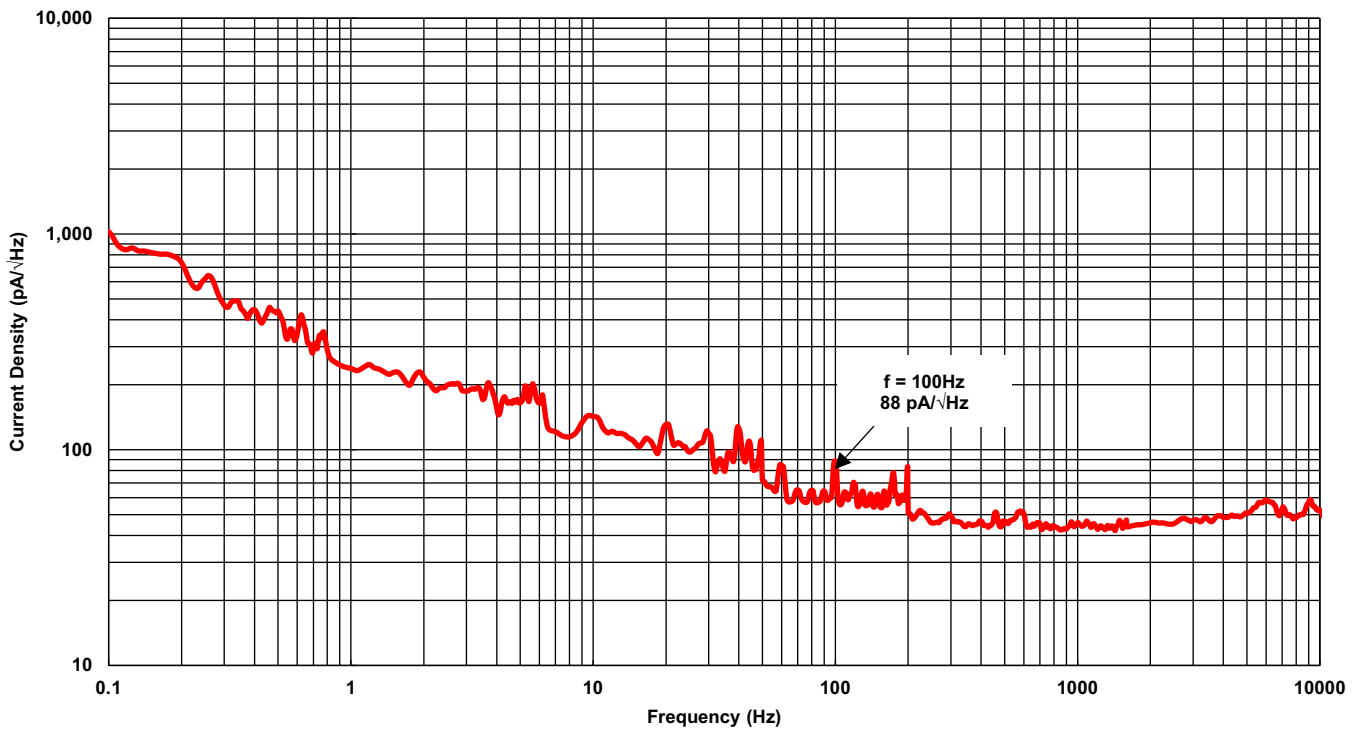

Figure 19. Noise Current Density

ISL7x592SEH 1mA: Unless otherwise noted, +V = 20V; -V = 0V; T_A = +25°C

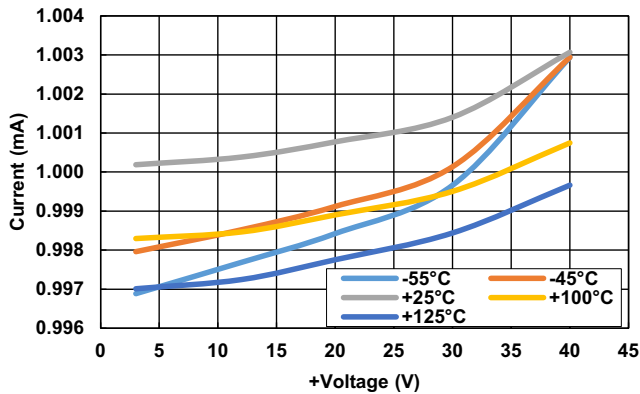

Figure 20. Output Current vs Voltage vs Temperature

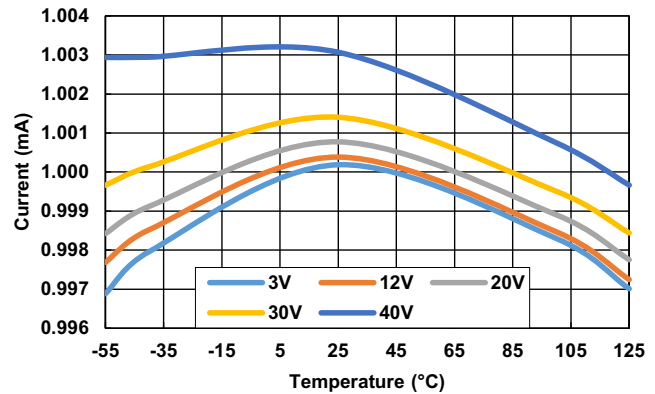

Figure 21. Output Current vs Temperature vs Voltage

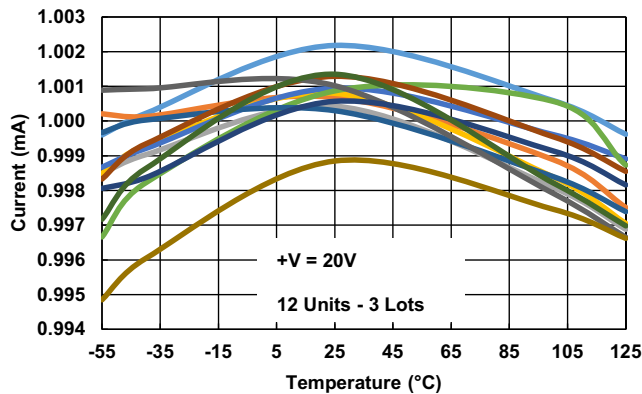
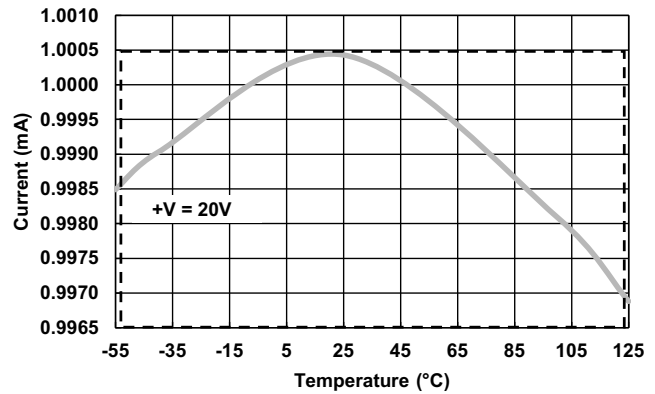

Figure 22. Output Current vs Temperature vs (12 units - 3 lots)



$$1.00043\text{mA} - 0.99688\text{mA}/180^\circ\text{C} = 0.00355\text{mA}/180^\circ\text{C} = 19.7\text{nA}/^\circ\text{C}$$

$$[19.7\text{nA}/^\circ\text{C}/1\text{mA}] \times 10^6 = 19.7\text{ppm}/^\circ\text{C}$$

Figure 23. Temperature Coefficient at +V = 20V

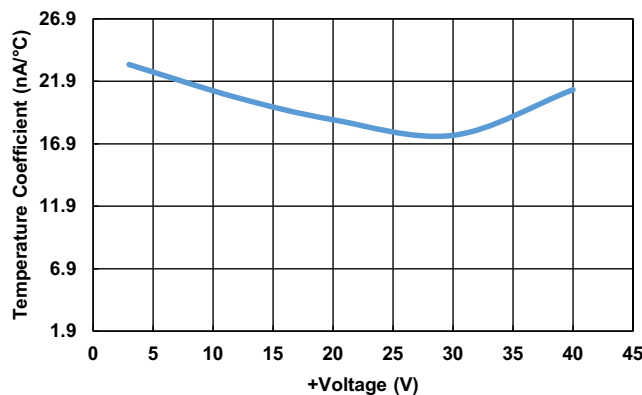

Figure 24. Output Current Temperature Coefficient vs Voltage

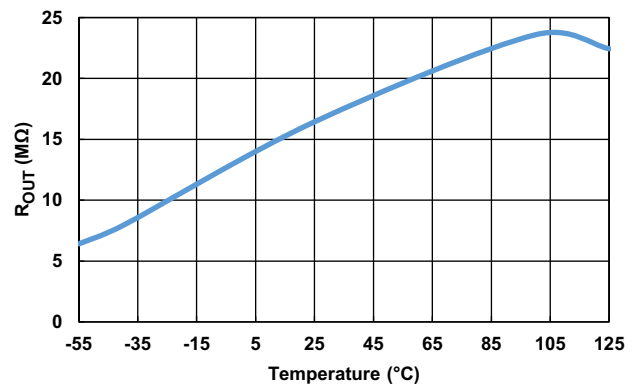

Figure 25. Output Impedance (R_{OUT}) vs Temperature

ISL7x592SEH 1mA: Unless otherwise noted, +V = 20V; -V = 0V; T_A = +25°C (Continued)

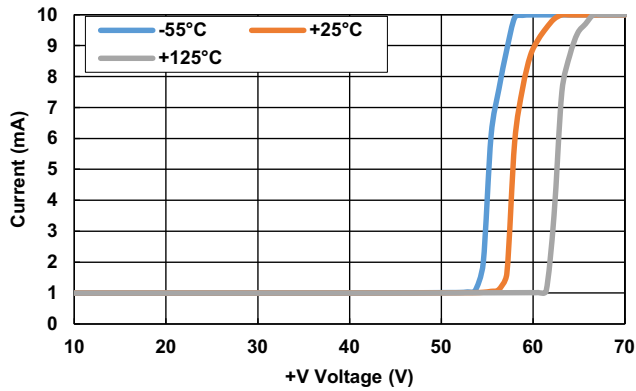

Figure 26. +V Breakdown Voltage

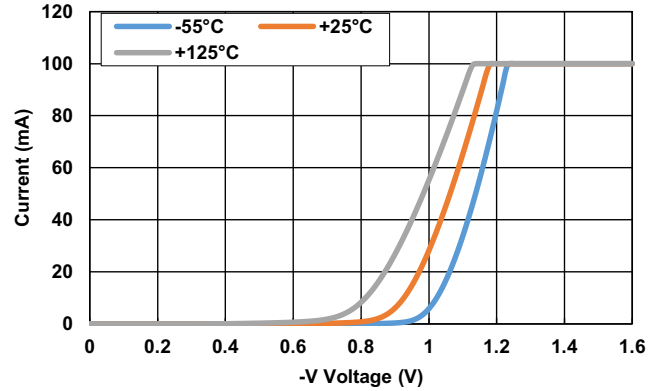

Figure 27. Reverse (-V) Breakdown Voltage

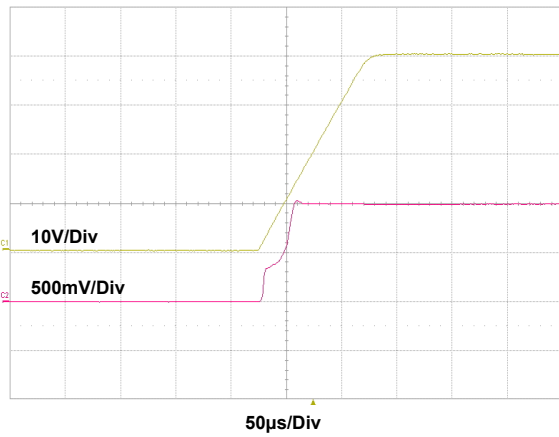

Figure 28. Turn on Time Plot (40V/100µs Ramp)

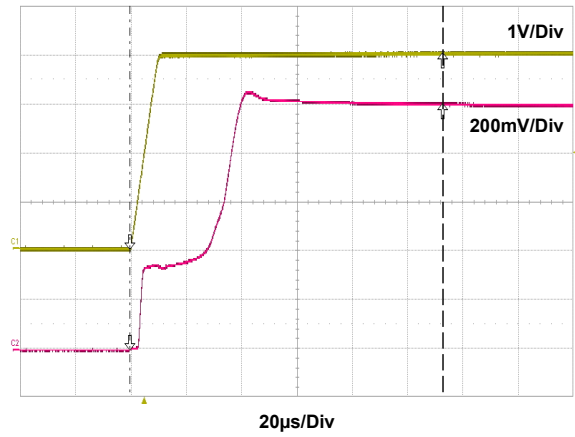

Figure 29. Turn on Time Plot (4V/10µs Ramp)

ISL7x592SEH 1mA: Unless otherwise noted, +V = 20V; -V = 0V; T_A = +25°C (Continued)

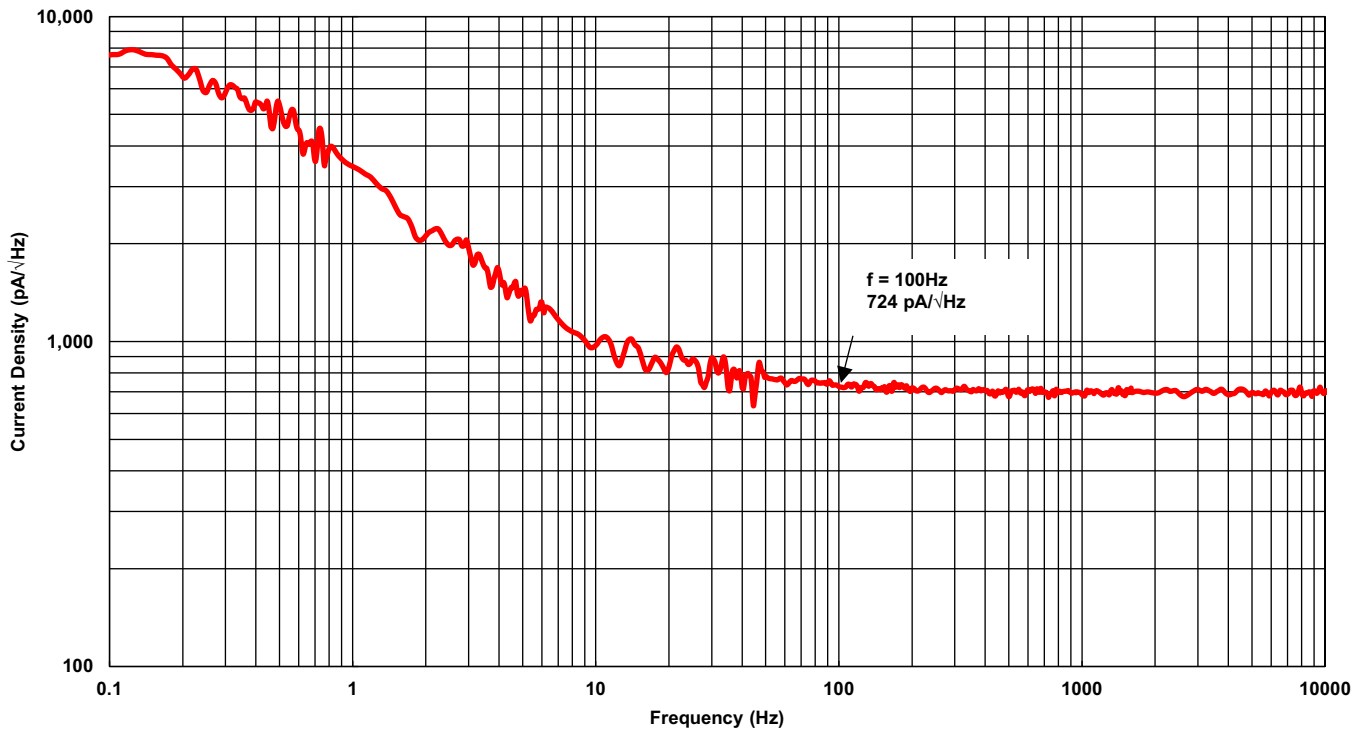

Figure 30. Noise Current Density

4. Applications Information

4.1 Functional Description

The ISL7x591SEH and ISL7x592SEH are radiation hardened, precision constant current source ICs. The ISL70591SEH and ISL73591SEH are 100 μ A current sources and the ISL70592SEH and ISL73592SEH are 1mA current sources. The devices use a bandgap, servo amplifier, and special resistance trimming circuitry architecture to produce with $\pm 1\%$ accuracy a current source across both a wide compliance voltage range of 3V to 40V and a temperature range of -55°C to $+125^{\circ}\text{C}$.

The two terminal floating type current sources can be used for high side load, low side load, or dual side load applications such as sensor excitation, biasing networks, low voltage references, floating voltage references, and ramp generators. The radiation hardened ICs are primarily designed for thermistor and other sensor excitation applications widely used in spacecrafts.

4.2 Temperature Coefficient

The typical value given for temperature coefficient (Tempco) is governed by the method of measurement. The overwhelming standard for specifying the temperature drift of a current source is to measure the current at two temperatures. Measuring the current at two temperatures provides for the maximum current deviation and takes the total variation, $(I_{\text{HIGH}} - I_{\text{LOW}})$. The total variation is divided by the temperature extremes of measurement $(T_{\text{HIGH}} - T_{\text{LOW}})$ to yield $\text{nA}/^{\circ}\text{C}$. The result is divided by the nominal reference current (at $T = +25^{\circ}\text{C}$) and multiplied by 10^6 to yield $\text{ppm}/^{\circ}\text{C}$, which is the “Box” method for specifying temperature coefficient. For the temperature coefficient of the ISL7x0591SEH see [Figures 12](#) and [13](#), and for the ISL7x0592SEH, see [Figures 23](#) and [24](#).

4.3 Floating Current Source Topology

The ISL7059xSEH and ISL73059xSEH devices are two terminal completely floating current sources. All the current entering the +V pin exits the -V pin. This allows for the circuit loading to be applied at the positive side (+V), or the negative side (-V), or at both the +V and -V sides of the current source.

The floating topology allows the current source to be used in a variety of applications that require loads to be connected as a “High Side Load”, “Low Side Load”, and “Dual Side Load.”

4.3.1 High Side Load

Connect the current source to a negative power supply or ground on the negative voltage lead (-V). Connect the load between the positive voltage lead (+V) of the current source and to a positive power supply.

4.3.2 Low Side Load

Connect the current source directly to a positive power supply on the positive voltage lead (+V). Connect the load to the negative voltage lead (-V) and to either a negative power supply or to ground.

4.3.3 Dual Load Side

Connect the current source’s first load to the positive voltage lead (+V) and a positive power supply. Connect the second load to the negative voltage lead (-V) and to either a negative power supply or to ground.

4.4 Power Supply Recommendations

The ISL7059xSEH and ISL73059xSEH devices have a wide compliance voltage range from 3V to 40V in terrestrial applications and 3V to 35V in space applications.

A minimum of at least 3V must be maintained across the current source for proper functionality. As the voltage across the current source drops below 3V, the current drops significantly and the part no longer operates as a current source.

4.5 Connecting Multiple Current Sources in Parallel for Higher Drive Current

The user can parallel multiple current sources together to build a current source with higher current capability. The current into the circuit load from paralleled current sources is equal to the summation of the current from each current source. For example, two ISL70592SEH current sources in parallel supplies 2mA of current to the circuit while three in parallel provides 3mA of current. A ISL70591SEH and ISL70592SEH in parallel provides 1.1mA to the load circuitry. The number of current sources you can connect in parallel is theoretically unlimited as long as the circuit loading maintains at least 3V across the +V and -V terminals of the ISL7059xSEH and ISL73059xSEH devices.

4.6 Circuit Considerations

- DNC Pins (Pin 2 and Pin 3): The pins are for trimming purpose and for factory use only. Do not connect these pins to the circuit in any way. It adversely effects the performance of the current source.
- A minimum of at least 3V must be maintained across the current source from +V to -V for proper functionality. As the voltage across the current source drops below 3V, the current out of the part drops off significantly and no longer functions as a current source.
- The maximum +V voltage compliance in a radiation environment should not exceed +35V. This family of current sources were tested under an ion beam at an LET of 86MeV•cm²/mg and did not latch-up or burn out to +V of 35V and +125°C. The maximum +V voltage in terrestrial environment should not exceed +40V.
- The current source has a reverse current ABS maximum rating of -0.5V. Use a protection circuitry such as a parallel Schottky diode across the current source to prevent the reverse voltage from exceeding -0.5V.

5. Die Characteristics

Table 2. Die and Assembly Related Information

Die Information	
Dimensions	2413 μ m x 1397 μ m (95 mils x 55 mils) Thickness: 483 μ m \pm 25.4 μ m (19 mils \pm 1 mil)
Interface Materials	
Glassivation	Type: 15kA Nitrox
Top Metallization	Type: AlCu (99.5%/0.5%) Thickness: 30kA
Backside Finish	Silicon
Process	Dielectrically Isolated Advanced Bipolar Technology - PR40
Assembly Information	
Substrate Potential	Float
Additional Information	
Transistor Count	155
Weight of Packaged Device	0.24 Grams (typical) - K4.A Package
Lid Characteristics	Finish: Gold Potential: Tied to -V pin (Pin 4)

6. Metallization Mask Layout

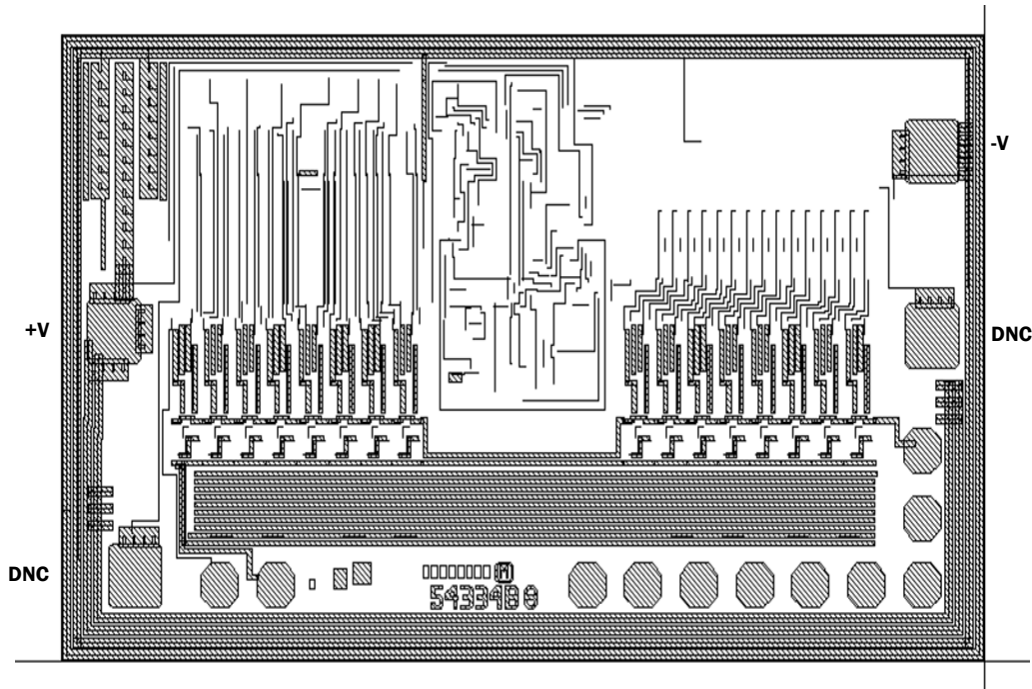

Table 3. Layout X-Y Coordinates

Pad Name	Pad Number	X (μm)	Y (μm)	dX (μm)	dY (μm)
+V	1	-1025.5	34.5	110.0	110.0
DNC	2	-	-	-	-
DNC	3	-	-	-	-
-V	4	1025.5	408.0	110.0	110.0

Note: Origin of the coordinates is the center of the die. Pads sorted in counter clock wise direction.

7. Revision History

Rev.	Date	Change
0.00	Aug 30, 2018	Initial Release

8. Package Outline Drawing

For the most recent package outline drawing, see [K4.A](#).

K4.A

4 Lead Ceramic Metal Seal Flatpack Package (100 mil Lead Pitch)

Rev 0, 3/17

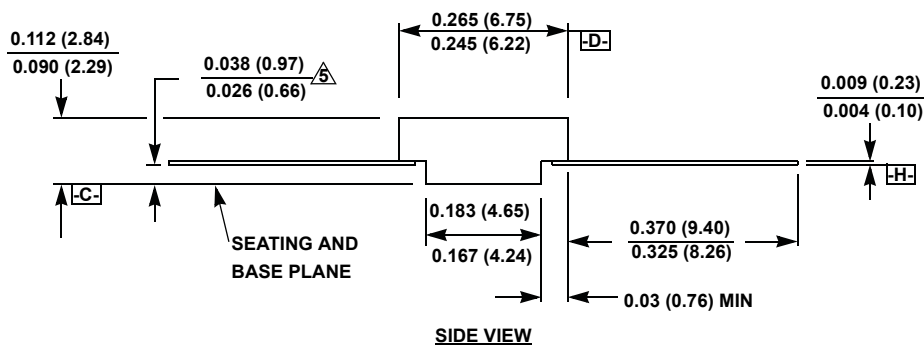
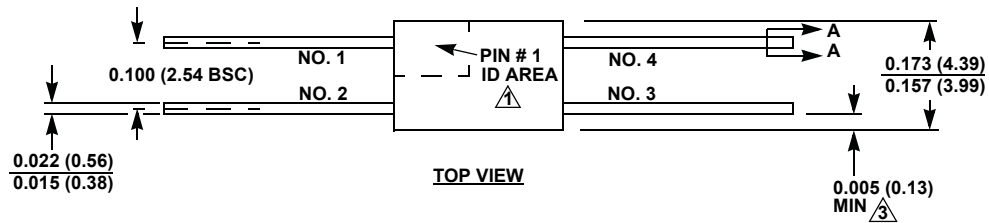

BOTTOM VIEW

NOTES:

1. Index area: A notch or a pin 1 identification mark shall be located adjacent to pin 1 and shall be located within the shaded area shown. The manufacturer's identification shall not be used as a pin 1 identification mark.
2. The maximum limits of lead dimensions (Section A-A) shall be measured at the centroid of the finished lead surfaces, when solder dip or tin plate lead finish is applied.
3. Measure dimension at all four corners.
4. For bottom-brazed lead packages, no organic or polymeric materials shall be molded to the bottom of the package to cover the leads.
5. Dimension shall be measured at the point of exit (beyond the meniscus) of the lead from the body. Dimension minimum shall be reduced by 0.0015 inch (0.038mm) maximum when solder dip lead finish is applied.
6. The bottom of the package is a ceramic surface.
7. Dimensioning and tolerancing per ASME Y14.5M-1994.
8. Dimensions: INCH (mm), Controlling dimension: INCH.

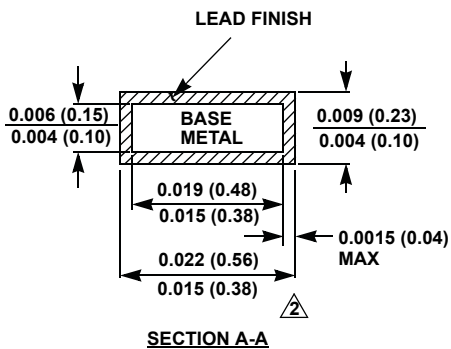

Notice

1. Descriptions of circuits, software and other related information in this document are provided only to illustrate the operation of semiconductor products and application examples. You are fully responsible for the incorporation or any other use of the circuits, software, and information in the design of your product or system. Renesas Electronics disclaims any and all liability for any losses and damages incurred by you or third parties arising from the use of these circuits, software, or information.
2. Renesas Electronics hereby expressly disclaims any warranties against and liability for infringement or any other claims involving patents, copyrights, or other intellectual property rights of third parties, by or arising from the use of Renesas Electronics products or technical information described in this document, including but not limited to, the product data, drawings, charts, programs, algorithms, and application examples.
3. No license, express, implied or otherwise, is granted hereby under any patents, copyrights or other intellectual property rights of Renesas Electronics or others.
4. You shall not alter, modify, copy, or reverse engineer any Renesas Electronics product, whether in whole or in part. Renesas Electronics disclaims any and all liability for any losses or damages incurred by you or third parties arising from such alteration, modification, copying or reverse engineering.
5. Renesas Electronics products are classified according to the following two quality grades: "Standard" and "High Quality". The intended applications for each Renesas Electronics product depends on the product's quality grade, as indicated below.
"Standard": Computers; office equipment; communications equipment; test and measurement equipment; audio and visual equipment; home electronic appliances; machine tools; personal electronic equipment; industrial robots; etc.
"High Quality": Transportation equipment (automobiles, trains, ships, etc.); traffic control (traffic lights); large-scale communication equipment; key financial terminal systems; safety control equipment; etc.
Unless expressly designated as a high reliability product or a product for harsh environments in a Renesas Electronics data sheet or other Renesas Electronics document, Renesas Electronics products are not intended or authorized for use in products or systems that may pose a direct threat to human life or bodily injury (artificial life support devices or systems; surgical implantations; etc.), or may cause serious property damage (space system; undersea repeaters; nuclear power control systems; aircraft control systems; key plant systems; military equipment; etc.). Renesas Electronics disclaims any and all liability for any damages or losses incurred by you or any third parties arising from the use of any Renesas Electronics product that is inconsistent with any Renesas Electronics data sheet, user's manual or other Renesas Electronics document.
6. When using Renesas Electronics products, refer to the latest product information (data sheets, user's manuals, application notes, "General Notes for Handling and Using Semiconductor Devices" in the reliability handbook, etc.), and ensure that usage conditions are within the ranges specified by Renesas Electronics with respect to maximum ratings, operating power supply voltage range, heat dissipation characteristics, installation, etc. Renesas Electronics disclaims any and all liability for any malfunctions, failure or accident arising out of the use of Renesas Electronics products outside of such specified ranges.
7. Although Renesas Electronics endeavors to improve the quality and reliability of Renesas Electronics products, semiconductor products have specific characteristics, such as the occurrence of failure at a certain rate and malfunctions under certain use conditions. Unless designated as a high reliability product or a product for harsh environments in a Renesas Electronics data sheet or other Renesas Electronics document, Renesas Electronics products are not subject to radiation resistance design. You are responsible for implementing safety measures to guard against the possibility of bodily injury, injury or damage caused by fire, and/or danger to the public in the event of a failure or malfunction of Renesas Electronics products, such as safety design for hardware and software, including but not limited to redundancy, fire control and malfunction prevention, appropriate treatment for aging degradation or any other appropriate measures. Because the evaluation of microcomputer software alone is very difficult and impractical, you are responsible for evaluating the safety of the final products or systems manufactured by you.
8. Please contact a Renesas Electronics sales office for details as to environmental matters such as the environmental compatibility of each Renesas Electronics product. You are responsible for carefully and sufficiently investigating applicable laws and regulations that regulate the inclusion or use of controlled substances, including without limitation, the EU RoHS Directive, and using Renesas Electronics products in compliance with all these applicable laws and regulations. Renesas Electronics disclaims any and all liability for damages or losses occurring as a result of your noncompliance with applicable laws and regulations.
9. Renesas Electronics products and technologies shall not be used for or incorporated into any products or systems whose manufacture, use, or sale is prohibited under any applicable domestic or foreign laws or regulations. You shall comply with any applicable export control laws and regulations promulgated and administered by the governments of any countries asserting jurisdiction over the parties or transactions.
10. It is the responsibility of the buyer or distributor of Renesas Electronics products, or any other party who distributes, disposes of, or otherwise sells or transfers the product to a third party, to notify such third party in advance of the contents and conditions set forth in this document.
11. This document shall not be reprinted, reproduced or duplicated in any form, in whole or in part, without prior written consent of Renesas Electronics.
12. Please contact a Renesas Electronics sales office if you have any questions regarding the information contained in this document or Renesas Electronics products.
(Note 1) "Renesas Electronics" as used in this document means Renesas Electronics Corporation and also includes its directly or indirectly controlled subsidiaries.
(Note 2) "Renesas Electronics product(s)" means any product developed or manufactured by or for Renesas Electronics.

(Rev.4.0-1 November 2017)



SALES OFFICES

Renesas Electronics Corporation

<http://www.renesas.com>

Refer to "<http://www.renesas.com>" for the latest and detailed information.

California Eastern Laboratories, Inc.

4590 Patrick Henry Drive, Santa Clara, California 95054-1817, U.S.A.
Tel: +1-408-919-2500, Fax: +1-408-988-0279

Renesas Electronics Canada Limited

9251 Yonge Street, Suite 8309 Richmond Hill, Ontario Canada L4C 9T3
Tel: +1-905-237-2004

Renesas Electronics Europe Limited

Dukes Meadow, Millboard Road, Bourne End, Buckinghamshire, SL8 5FH, U.K
Tel: +44-1628-651-700

Renesas Electronics Europe GmbH

Arcadiastrasse 10, 40472 Düsseldorf, Germany
Tel: +49-211-6503-0, Fax: +49-211-6503-1327

Renesas Electronics (China) Co., Ltd.

Room 1709 Quantum Plaza, No.27 ZhichunLu, Haidian District, Beijing, 100191 P. R. China
Tel: +86-10-8235-1155, Fax: +86-10-8235-7679

Renesas Electronics (Shanghai) Co., Ltd.

Unit 301, Tower A, Central Towers, 555 Langao Road, Putuo District, Shanghai, 200333 P. R. China
Tel: +86-21-2226-0888, Fax: +86-21-2226-0999

Renesas Electronics Hong Kong Limited

Unit 1601-1611, 16/F., Tower 2, Grand Century Place, 193 Prince Edward Road West, Mongkok, Kowloon, Hong Kong
Tel: +852-2265-6688, Fax: +852 2886-9022

Renesas Electronics Taiwan Co., Ltd.

13F, No. 363, Fu Shing North Road, Taipei 10543, Taiwan
Tel: +886-2-8175-9600, Fax: +886 2-8175-9670

Renesas Electronics Singapore Pte. Ltd.

80 Bendemeer Road, Unit #06-02 Hyflux Innovation Centre, Singapore 339949
Tel: +65-6213-0200, Fax: +65-6213-0300

Renesas Electronics Malaysia Sdn.Bhd.

Unit 1207, Block B, Menara Amcorp, Amcorp Trade Centre, No. 18, Jln Persiaran Barat, 46050 Petaling Jaya, Selangor Darul Ehsan, Malaysia
Tel: +60-3-7955-9390, Fax: +60-3-7955-9510

Renesas Electronics India Pvt. Ltd.

No.777C, 100 Feet Road, HAL 2nd Stage, Indiranagar, Bangalore 560 038, India
Tel: +91-80-67208700, Fax: +91-80-67208777

Renesas Electronics Korea Co., Ltd.

17F, KAMCO Yangjae Tower, 262, Gangnam-daero, Gangnam-gu, Seoul, 06265 Korea
Tel: +82-2-558-3737, Fax: +82-2-558-5338