

ISL15102A

Single Port, PLC Differential Line Driver

FN8950
Rev.0.00
Dec 8, 2017

The ISL15102A is a single port differential line driver developed for Power Line Communication (PLC) applications. The device is designed to drive heavy line loads while maintaining a high level of linearity required in Orthogonal Frequency Division Multiplexing (OFDM) PLC modem links.

The ISL15102A has a disable control pin (DIS). In Disable mode, the line driver goes into Low Power mode and the outputs maintain a high impedance in the presence of high receive signal amplitude, improving TDM receive signal integrity.

The ISL15102A has built-in thermal protection. When the internal temperature reaches +150°C (typical) the driver shuts down to prevent damage to the device.

An internal input CM buffer maximizes the dynamic range and reduces the number of external components in the application circuit.

The ISL15102A is supplied in a thermally-enhanced small footprint (4mmx5mm) 24 Ld QFN package. The ISL15102A is specified for operation across the -40°C to +85°C ambient temperature range.

Features

- Single differential driver
- Internal V_{CM} without external filter capacitor
- 90MHz signal bandwidth
- 900V/ μ s slew rate
- Single +8V to +28V supply, absolute maximum 30V
- Supports narrowband and broadband DMT PLC
- -86dB THD at 200kHz into 50 Ω line load
- -70dB THD at 3MHz into 50 Ω line load
- Control pin for enable/disable for TDM operation
- Thermal shutdown

Table 1. Alternate Solutions

Part #	Nominal $\pm V_S$ (V)	Bandwidth (MHz)	Applications
ISL15100	$\pm 6, +12$	180	Broadband PLC
ISL1571	$\pm 6, +12$	250	Broadband PLC
ISL15110	$\pm 6, +12$	120	MIMO PLC

Applications

- Power line communication differential driver

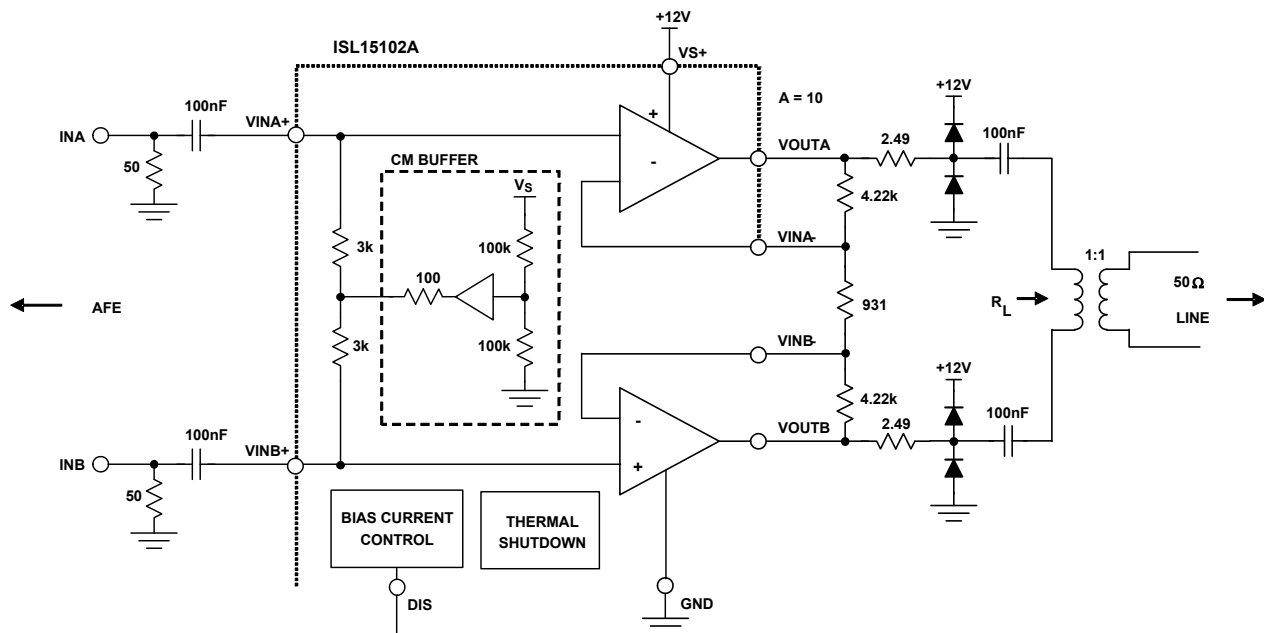

Figure 1. Typical Application Circuit

1. Overview

1.1 Ordering Information

Part Number (Notes 2, 3)	Part Marking	Operating Ambient Temp Range (°C)	Tape and Reel (Units)	Package (RoHS Compliant)	Pkg. Dwg. #
ISL15102AIRZ	15102AIRZ	-40 to +85	-	24 Ld QFN	L24.4x5F
ISL15102AIRZ-T13 (Note 1)	15102AIRZ	-40 to +85	2.5k	24 Ld QFN	L24.4x5F

Notes:

1. Refer to [TB347](#) for details on reel specifications.
2. These Pb-free plastic packaged products employ special Pb-free material sets, molding compounds/die attach materials, and 100% matte tin plate plus anneal (e3 termination finish, which is RoHS compliant and compatible with both SnPb and Pb-free soldering operations). Intersil Pb-free products are MSL classified at Pb-free peak reflow temperatures that meet or exceed the Pb-free requirements of IPC/JEDEC J STD-020.
3. For more information on MSL, see [TB363](#).

1.2 Pin Configurations

ISL15102A
(24 Ld QFN)

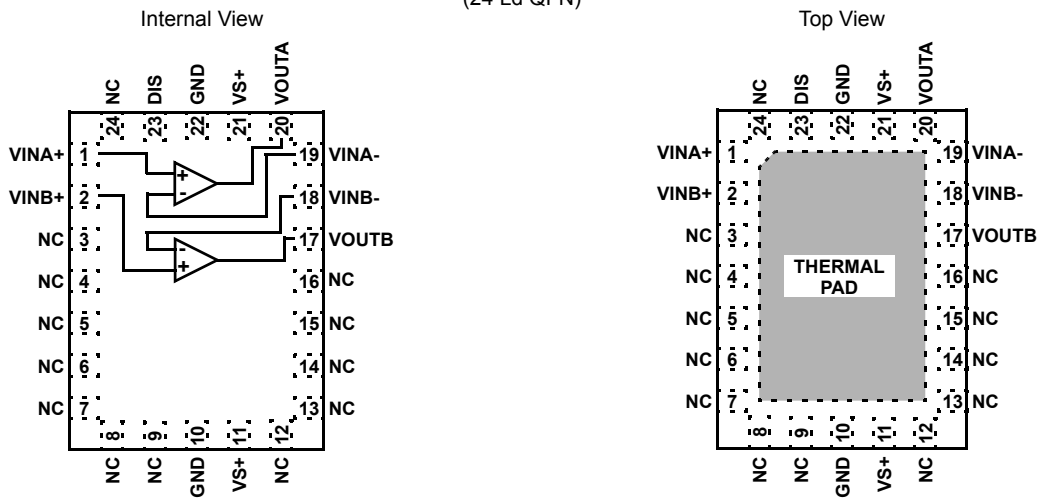

1.3 Pin Descriptions

Pin Number	Pin Name	Function	Circuit
1	VINA+	Amplifier A noninverting input	Refer to Circuit 1
2	VINB+	Amplifier B noninverting input	Refer to Circuit 1
10, 22	GND	Ground connection	
3, 4, 5, 6, 7, 8, 9, 12, 13, 14, 15, 16, 24	NC	No internal connection	
11, 21	VS+	Positive supply voltage	
17	VOUSB	Amplifier B output	Refer to Circuit 2
18	VINB-	Amplifier B inverting input	Refer to Circuit 3
19	VINA-	Amplifier A inverting input	Refer to Circuit 3
20	VOUSA	Amplifier A output	Refer to Circuit 2
23	DIS	Disable control pin	
-	Thermal Pad	Connects to GND	

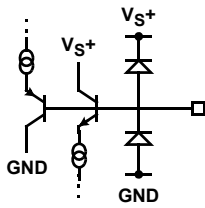

Circuit 1

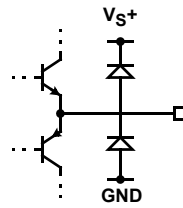

Circuit 2

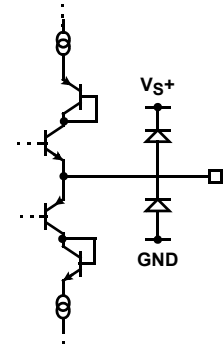

Circuit 3

2. Specifications

2.1 Absolute Maximum Ratings

$T_A = +25^\circ\text{C}$

Parameter	Minimum	Maximum	Unit
V_{S+} Voltage to GND	-0.3	30	V
Driver V_{IN+} Voltage	GND	V_{S+}	V
DIS Voltage to GND	-0.3	6	V
V_{CM} Voltage to GND	GND	V_{S+}	
ESD Rating	Value		Unit
Human Body Model (Tested per JS-001-2014)	2		kV
Charged Device Model (Tested per JS-002-2014)	750		kV

CAUTION: Do not operate at or near the maximum ratings listed for extended periods of time. Exposure to such conditions may adversely impact product reliability and result in failures not covered by warranty.

2.2 Thermal Information

Thermal Resistance (Typical)	θ_{JA} ($^\circ\text{C}/\text{W}$)	θ_{JC} ($^\circ\text{C}/\text{W}$)
24 Ld QFN Package (Notes 4, 5)	38	4

Notes:

- θ_{JA} is measured in free air with the component mounted on a high-effective thermal conductivity test board with "direct attach" features. See [TB379](#).
- For θ_{JC} , the "case temp" location is the center of the exposed metal pad on the package underside.

Parameter	Minimum	Maximum	Unit
Power Dissipation	see Figure 14 on page 9		
Storage Temperature Range	-65	+150	$^\circ\text{C}$
Pb-Free Reflow Profile	Refer to TB493		

2.3 Recommended Operation Conditions

Parameter	Minimum	Maximum	Unit
Temperature Range	-40	+85	$^\circ\text{C}$
Junction Temperature	-40	+150	$^\circ\text{C}$

2.4 Electrical Specifications

Unless otherwise noted, all tests are at the specified temperature $T_A = +25^\circ\text{C}$, $V_{S+} = +12\text{V}$, $A_V = 10\text{V/V}$, $R_F = 4.22\text{k}\Omega$, $R_L = 50\Omega$ differential, $\text{DIS} = 0\text{V}$.

Parameter	Symbol	Test Conditions	Min (Note 6)	Typ (Note 7)	Max (Note 6)	Unit
AC Performance						
-3dB Small Signal Bandwidth	BW	$V_O < 2V_{P-P-DIFF}$		90		MHz
-3dB Large Signal Bandwidth		$V_O = 10V_{P-P-DIFF}$		60		MHz
20% to 80%	SR	$V_O = 10V_{P-P-DIFF}$		900		V/ μs
200kHz Harmonic Distortion	2nd Harmonic	$V_{OUT} = 2V_{P-P-DIFF}$		-88		dBc
	3rd Harmonic	$V_{OUT} = 2V_{P-P-DIFF}$		-92		dBc
	THD	$V_{OUT} = 2V_{P-P-DIFF}$		-86		dBc
3MHz Harmonic Distortion	2nd Harmonic	$V_{OUT} = 2V_{P-P-DIFF}$		-83		dBc
	3rd Harmonic	$V_{OUT} = 2V_{P-P-DIFF}$		-70		dBc
	THD	$V_{OUT} = 2V_{P-P-DIFF}$		-70		dBc
6MHz Harmonic Distortion	2nd Harmonic	$V_{OUT} = 2V_{P-P-DIFF}$		-76		dBc
	3rd Harmonic	$V_{OUT} = 2V_{P-P-DIFF}$		-66		dBc
	THD	$V_{OUT} = 2V_{P-P-DIFF}$		-65		dBc
Non-Inverting Input Voltage Noise at each of the Two Inputs	e_N	$f = 1\text{MHz}$		8.5		nV/ $\sqrt{\text{Hz}}$
Non-Inverting Input Current Noise at each of the Two Inputs	$+i_N$	$f = 1\text{MHz}$		1.5		pA/ $\sqrt{\text{Hz}}$
Inverting Input Current Noise at each of the Two Inputs	$-i_N$	$f = 1\text{MHz}$		38		pA/ $\sqrt{\text{Hz}}$
Common-Mode Output Noise	e_{N-CM}	$f = 1\text{MHz}$		128		nV/ $\sqrt{\text{Hz}}$
Power Control Features						
Logic High Voltage	V_{IH}	DIS input	2.0			V
Logic Low Voltage	V_{IL}	DIS input			0.8	V
Logic High Current for DIS	I_{IH}	DIS = 3.3V		0.3		μA
Logic Low Current for DIS	I_{IL}	DIS = 0V		-0.4		μA
Supply Characteristics						
Maximum Operating Supply Voltage				28		V
Minimum Operating Supply Voltage				8		V
GND Pin Current	I_{GND}	All outputs at 0V, DIS = 3.3V		0.4		mA
Positive Supply Current	I_{S+} (full power)	All outputs at $V_{S+}/2$, DIS = 0V, $V_{O-DIFF} = 0\text{V}$		21		mA
Positive Supply Current	I_{S+} (power-down)	All outputs at $V_{S+}/2$, DIS = 3.3V, $V_{O-DIFF} = 0\text{V}$		0.4		mA
Output Characteristics						
Unloaded Output Differential Swing	V_{OUT}	$R_{L-DIFF} = \text{no load}$		20		V_{P-P}
Input Characteristics						
Input Offset Voltage - Differential Mode	V_{IOS-DM}	($V_{INA+} - V_{INB+}$)	-17	-0.3	17	mV
Input Offset Voltage - Common-Mode	V_{IOS-CM}	Delta to $V_{S+}/2$	-17	4	17	mV
Input V_{OS} Drift	$V_{OS, DRIFT}$	-25°C to $+125^\circ\text{C}$ T_J		± 2		$\mu\text{V}/^\circ\text{C}$

Unless otherwise noted, all tests are at the specified temperature $T_A = +25^\circ\text{C}$, $V_{S+} = +12\text{V}$, $A_V = 10\text{V/V}$, $R_F = 4.22\text{k}\Omega$, $R_L = 50\Omega$ differential, $\text{DIS} = 0\text{V}$. **(Continued)**

Parameter	Symbol	Test Conditions	Min (Note 6)	Typ (Note 7)	Max (Note 6)	Unit
Non-Inverting Input Bias Current - Differential Mode	$+I_{\text{BDM}}$	$(+I_{\text{BA}} - +I_{\text{BB}})$	-3	0.2	3	μA
Inverting Input Bias Current - Differential Mode	$-I_{\text{BDM}}$	$(-I_{\text{BA}} - -I_{\text{BB}})$	-20	-0.6	20	μA
Non-Inverting $I_{\text{B+}}$ Drift	$I_{\text{B+}, \text{DRIFT}}$	-25°C to $+85^\circ\text{C}$ T_J		± 6		$\text{nA}/^\circ\text{C}$
Inverting $I_{\text{B-}}$ Drift	$I_{\text{B-}, \text{DRIFT}}$	-25°C to $+85^\circ\text{C}$ T_J		± 6		$\text{nA}/^\circ\text{C}$
Power Supply Rejections to Differential Output (Input Referred)	PSRR	$V_{\text{S+}} = +8\text{V}$ to $+28\text{V}$		68		dB
Power Supply Rejections to Common-Mode Output (Output Referred)		$V_{\text{S+}} = +8\text{V}$ to $+28\text{V}$		22		dB
Differential Input Resistance	Z_{IN}			6		$\text{k}\Omega$
Thermal Protection						
Thermal Shutdown			125	160		$^\circ\text{C}$

Notes:

6. Compliance to datasheet limits is assured by one or more methods: production test, characterization, and/or design.
7. Typical values are for information purposes only.

3. Typical Performance Curves

$V_{S+} = +12V$, $R_F = 4.22k\Omega$, $A_V = 10V/V$ differential, $R_L = 50\Omega$ differential, $T_A = +25^\circ C$, $DIS = 0V$, unless otherwise noted.

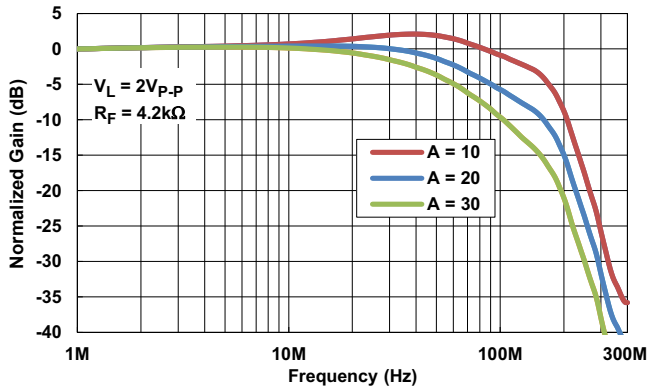

Figure 2. Small Signal Frequency Response vs Gain

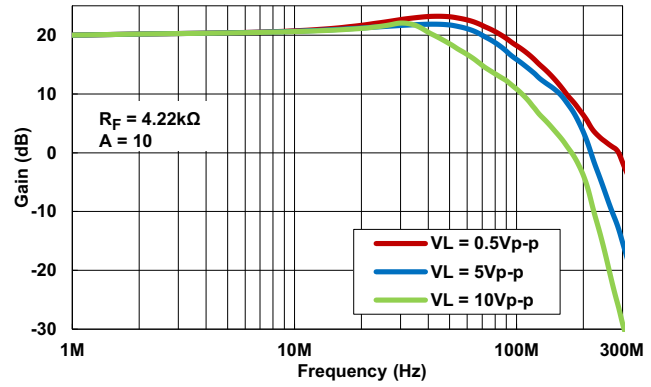

Figure 3. Large Signal Frequency Response

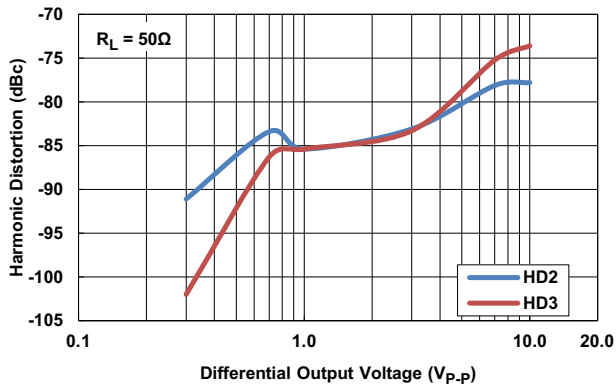

Figure 4. 1MHz Harmonic Distortion vs Output Swing

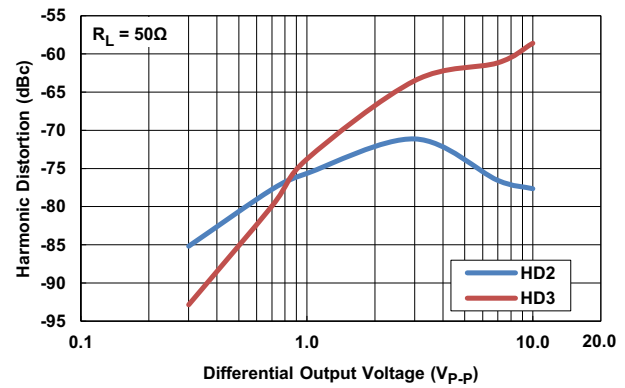

Figure 5. 4MHz Harmonic Distortion vs Output Swing

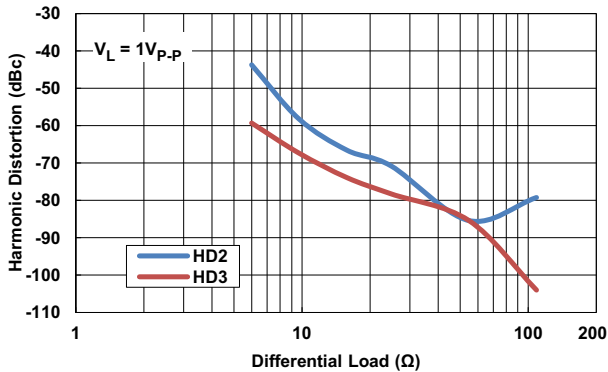

Figure 6. 1MHz Harmonic Distortion vs Load

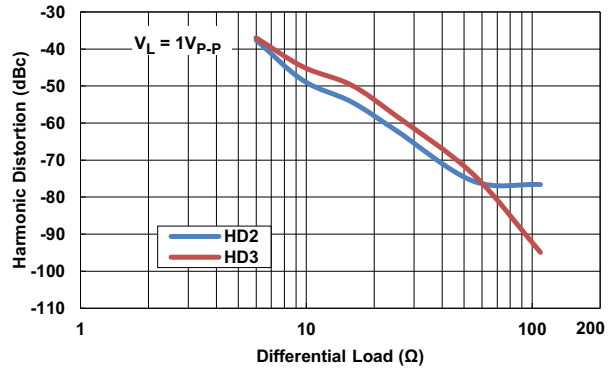

Figure 7. 4MHz Harmonic Distortion vs Load

$V_{S+} = +12V$, $R_F = 4.22k\Omega$, $A_V = 10V/V$ differential, $R_L = 50\Omega$ differential, $T_A = +25^\circ C$, $DIS = 0V$, unless otherwise noted. (Continued)

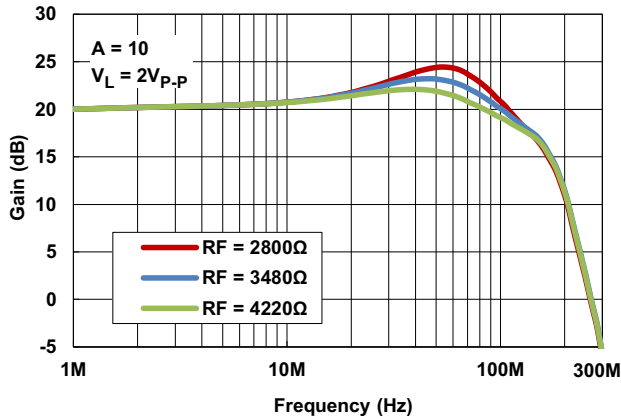

Figure 8. Small Signal Frequency Response vs R_F

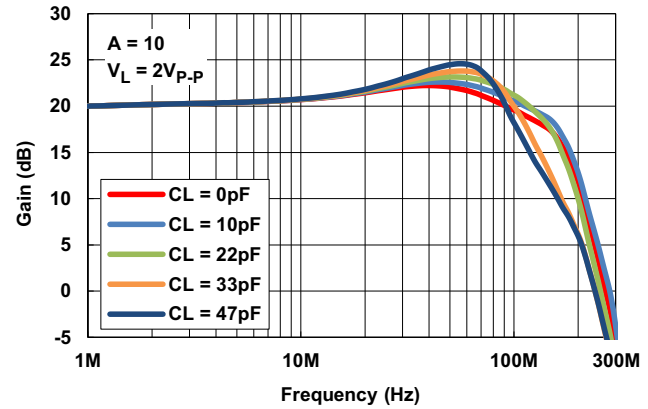

Figure 9. Small Signal Frequency Response vs C_{LOAD}

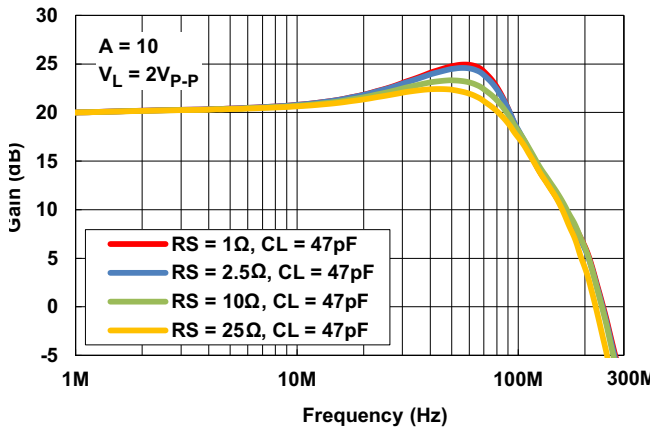

Figure 10. Small Signal Frequency Response vs R_S and C_{LOAD}

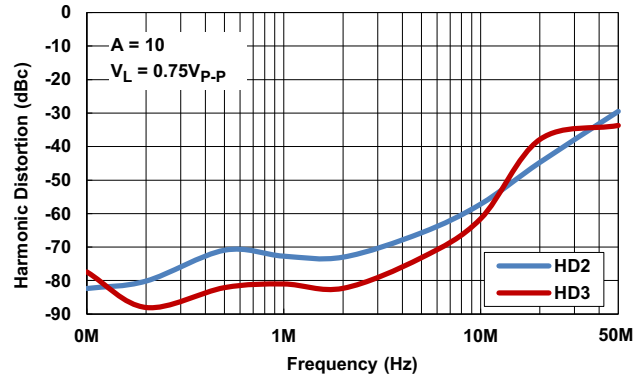

Figure 11. Harmonic Distortion vs Frequency

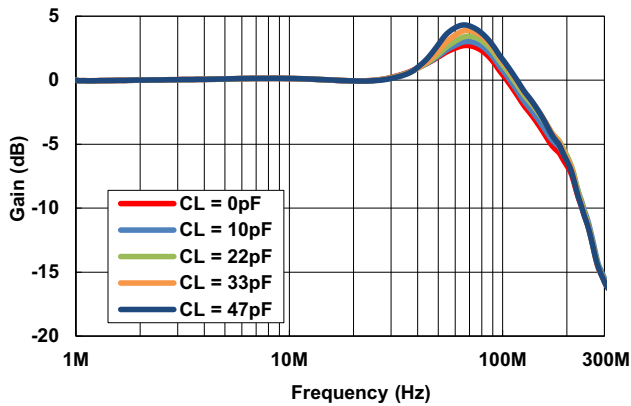

Figure 12. Common-Mode Small Signal Frequency Response vs C_{LOAD}

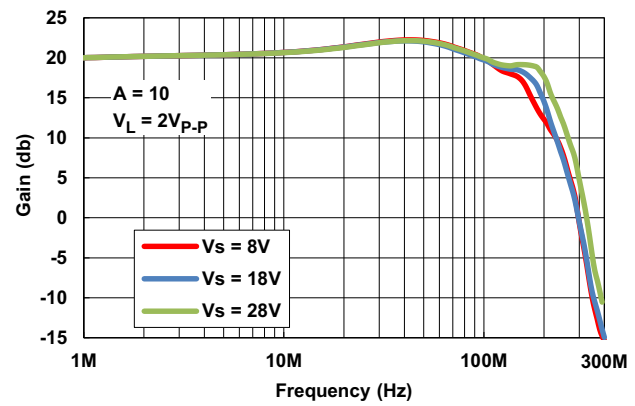

Figure 13. Small Signal Frequency Response vs Supply Voltage

$V_{S+} = +12V$, $R_F = 4.22k\Omega$, $A_V = 10V/V$ differential, $R_L = 50\Omega$ differential, $T_A = +25^\circ C$, $DIS = 0V$, unless otherwise noted. (Continued)

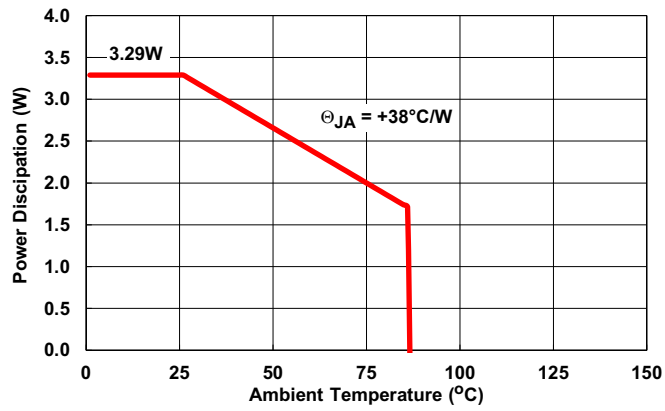

Figure 14. Package Power Dissipation vs Ambient Temperature

4. Test Circuit

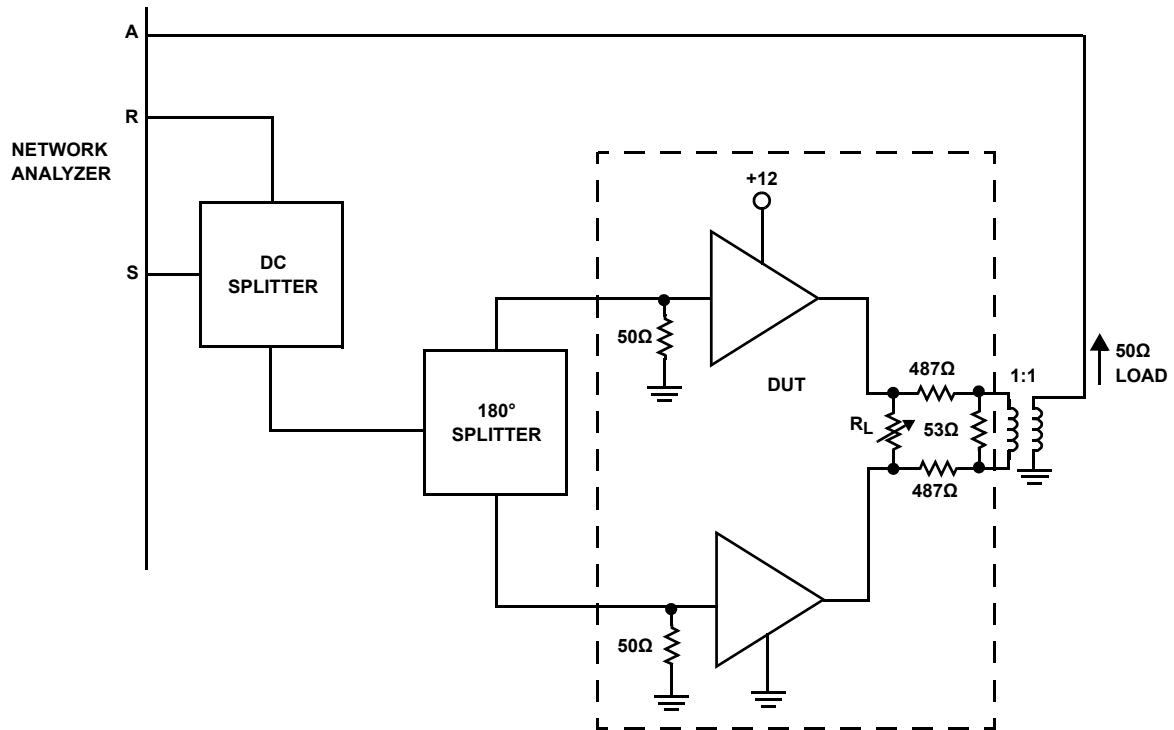

Figure 15. Frequency Response Characterization Circuit

5. Applications Information

5.1 Applying Wideband Current Feedback Op Amps as Differential Drivers

A Current Feedback Amplifier (CFA) such as the ISL15102A, is particularly suited to the requirements of high output power, high bandwidth, and differential drivers. This topology offers a high slew rate on low quiescent power and the ability to hold AC characteristics relatively constant over a wide range of gains. The AC characteristics are principally set by the feedback resistor (R_F) value in simple differential gain circuits as shown in [Figure 16](#).

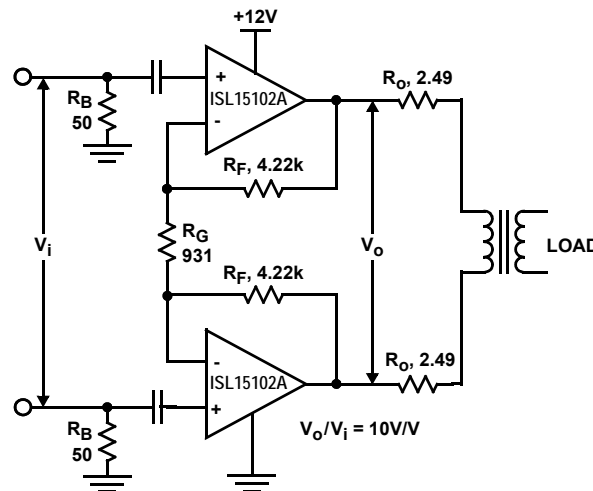

Figure 16. Passive Termination Circuit

In this differential gain of 10V/V circuit, the 4.22k feedback resistors (R_F) set the bandwidth, while the 931 gain resistor (R_G) controls the gain. The V_o/V_i gain for this circuit is set by [\(EQ. 1\)](#):

$$(EQ. 1) \quad \frac{V_o}{V_i} = 1 + \left(2 \cdot \frac{R_F}{R_G} \right) = 1 + \left(2 \cdot \frac{4.22k\Omega}{931\Omega} \right) = 10.06$$

The effect of increasing or decreasing the feedback resistor value is shown in [Figure 8](#). Increasing R_F will tend to roll off the response, while decreasing it will peak the frequency response up, extending the bandwidth. R_G was adjusted in each of these plots to hold a constant gain of 10 (or 20dB). This shows the flexibility offered by the CFA topology - the frequency response can be controlled with the value of the feedback resistor, R_F , with resistor R_G setting the desired gain.

The ISL15102A provides two very power efficient, high output current CFAs. These are intended to be connected as one differential driver. The [“Pin Configurations” on page 2](#) show that Channels A and B are intended to operate as a pair. Power-down control is provided through control pin DIS, which sets the power for Channels A and B together.

Very low output distortion at low power can be provided by the differential configuration. The high slew rate intrinsic to the CFA topology also contributes to the exceptional performance shown in [Figure 11 on page 8](#). This swept frequency distortion plot shows low distortion at 200kHz holding to very low levels up through 10MHz.

5.2 Input Biasing and Input Impedance

The ISL15102A has internal resistors at the noninverting inputs for mid-rail biasing, so only external AC coupling capacitors are required for input biasing, shown in [Figure 1 on page 1](#). With two 100nF coupling capacitors and an input differential impedance of 6kΩ typical, the first order high-pass cut-off frequency is 530Hz.

5.3 Power Control Function

DIS controls the quiescent current for the port constructed from Amplifiers A and B. Taking DIS high ($>2V$), will put the device in Power-Down mode, reducing the supply current to typical 0.4mA. Taking DIS low ($<0.8V$), will place the drive in Full Power mode, consuming typically 22mA supply current. [Table 2](#) summarizes the operation modes for ISL15102A.

Table 2. Power Modes of the ISL15102A

DIS	Operation
0	I_S Full Power
1	Power-Down

6. Performance Considerations

6.1 Driving Capacitive Loads

All closed-loop op amps are susceptible to reduced phase margin when driving capacitive loads. This shows up as peaking in the frequency response that can, in extreme situations, lead to oscillations. The ISL15102A is designed to operate successfully with small capacitive loads such as layout parasitics. As the parasitic capacitance increases, it is best to consider a small resistor in series with each output to isolate the phase margin effects of the capacitor. [Figure 9 on page 8](#) shows the effect of capacitive load on the differential gain-of-10 circuit. With 22pF on each output, we see about 3dB peaking. This will increase quickly at higher C_{LOADS} . If this degree of peaking is unacceptable, a small series resistor can be used to improve the flatness as shown in [Figure 10 on page 8](#).

6.2 Board Design Recommendations

The feedback resistors need to be placed as close as possible to the output and inverting input pins to minimize parasitic capacitance in the feedback loop. Keep the gain resistor also very close to the inverting inputs for its port and minimize parasitic capacitances to ground or power planes as well.

Close placement of the supply decoupling capacitors will minimize parasitic inductance in the supply path. High frequency load currents are typically pulled through these capacitors, so close placement of 0.01 μ F capacitors on each of the supply pins will improve dynamic performance. Higher valued capacitors, 6.8 μ F typically, can be placed further from the package as they are providing more of the low frequency decoupling.

The thermal pad for the ISL15102A should be connected to ground. It is recommended to fill the PCB metal beneath the thermal pad with a 3x3 array of vias to spread heat away from the package. The larger the PCB metal area, the lower the junction temperature will be.

While the ISL15102A is relatively robust in driving parasitic capacitive loads, it is always preferred to place any series output resistors as close as possible to the output pins. The trace capacitance on the other side of that resistor will have a much smaller effect on loop phase margin.

Protection devices that are intended to steer large load transients away from the ISL15102A output stage and into the power supplies or ground, should have a short trace from their supply connections into the nearest supply capacitor; or they should include their own supply capacitors to provide a low impedance path under fast transient conditions.

7. Revision History

Rev.	Date	Description
0.00	Dec 8, 2017	Initial release

8. Package Outline Drawing

For the most recent package outline drawing, see [L24.4x5F](#).

L24.4x5F
 24 LEAD QUAD FLAT NO-LEAD PLASTIC PACKAGE
 Rev 0, 5/14

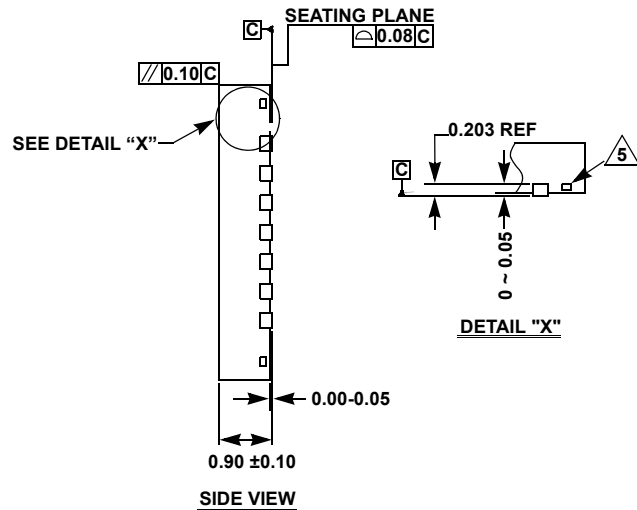
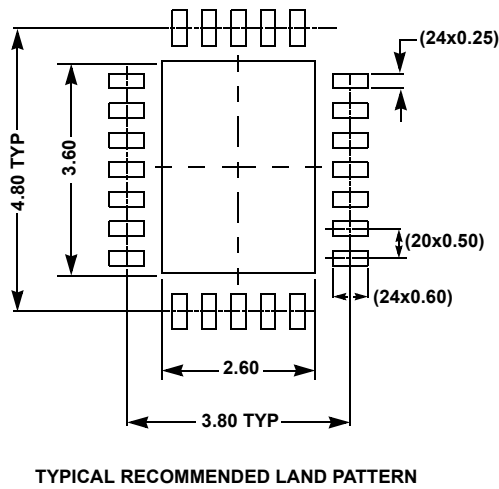
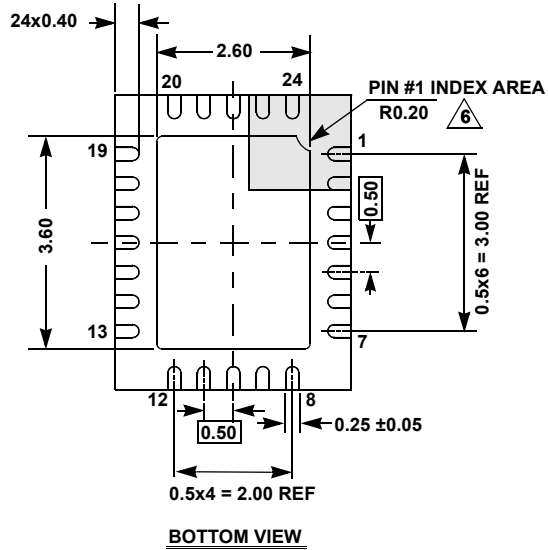
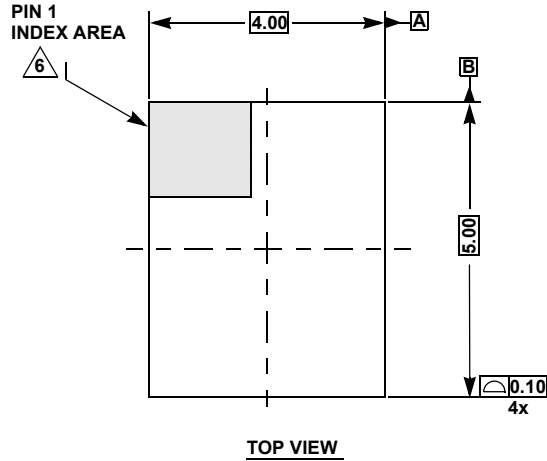

NOTES:

1. Dimensions are in millimeters.
 Dimensions in () are for Reference Only.
2. Dimensioning and tolerancing conform to ASMEY14.5m-1994.
3. Unless otherwise specified, tolerance: Decimal ± 0.05
4. Dimension applies to the metallized terminal and is measured between 0.20mm and 0.30mm from the terminal tip.
5. Tiebar shown (if present) is a non-functional feature.
6. The configuration of the pin #1 identifier is optional, but must be located within the zone indicated. The pin #1 identifier may be either a mold or mark feature.

9. About Intersil

Intersil Corporation is a leading provider of innovative power management and precision analog solutions. The company's products address some of the largest markets within the industrial and infrastructure, mobile computing and high-end consumer markets.

For the most updated datasheet, application notes, related documentation, and related parts, see the respective product information page found at www.intersil.com.

For a listing of definitions and abbreviations of common terms used in our documents, visit: www.intersil.com/glossary.

You can report errors or suggestions for improving this datasheet by visiting www.intersil.com/ask.

Reliability reports are also available from our website at www.intersil.com/support.

© Copyright Intersil Americas LLC 2017. All Rights Reserved.

All trademarks and registered trademarks are the property of their respective owners.

For additional products, see www.intersil.com/en/products.html

Intersil products are manufactured, assembled and tested utilizing ISO9001 quality systems as noted in the quality certifications found at www.intersil.com/en/support/qualandreliability.html

Intersil products are sold by description only. Intersil may modify the circuit design and/or specifications of products at any time without notice, provided that such modification does not, in Intersil's sole judgment, affect the form, fit or function of the product. Accordingly, the reader is cautioned to verify that datasheets are current before placing orders. Information furnished by Intersil is believed to be accurate and reliable. However, no responsibility is assumed by Intersil or its subsidiaries for its use; nor for any infringements of patents or other rights of third parties which may result from its use. No license is granted by implication or otherwise under any patent or patent rights of Intersil or its subsidiaries.

For information regarding Intersil Corporation and its products, see www.intersil.com