

## HS-1145RH

Radiation Hardened, High Speed, Low Power, Current Feedback Video Operational Amplifier with Output Disable

FN4227  
Rev 2.00  
February 14, 2005

The HS-1145RH is a high speed, low power current feedback amplifier built with Intersil's proprietary complementary bipolar UHF-1 (DI bonded wafer) process. These devices are QML approved and are processed and screened in full compliance with MIL-PRF-38535.

This amplifier features a TTL/CMOS compatible disable control, pin 8, which when pulled low, reduces the supply current and forces the output into a high impedance state. This allows easy implementation of simple, low power video switching and routing systems. Component and composite video systems also benefit from this op amp's excellent gain flatness, and good differential gain and phase specifications. Multiplexed A/D applications will also find the HS-1145RH useful as the A/D driver/multiplexer.

**Specifications for Rad Hard QML devices are controlled by the Defense Supply Center in Columbus (DSCC). The SMD numbers listed here must be used when ordering.**

Detailed Electrical Specifications for these devices are contained in SMD 5962-96830.

### Ordering Information

ORDERING NUMBER	INTERNAL MKT. NUMBER	TEMP. RANGE (°C)
5962F9683001VPC	HS7B-1145RH-Q	-55 to 125

### Features

- Electrically Screened to SMD # 5962-96830
- QML Qualified per MIL-PRF-38535 Requirements
- Low Supply Current . . . . . 5.9mA (Typ)
- Wide -3dB Bandwidth. . . . . 360MHz (Typ)
- High Slew Rate . . . . . 1000V/μs (Typ)
- Excellent Gain Flatness (to 50MHz). . . . . ±0.07dB (Typ)
- Excellent Differential Gain . . . . . 0.02% (Typ)
- Excellent Differential Phase . . . . . 0.03 Degrees (Typ)
- High Output Current . . . . . 60mA (Typ)
- Output Enable/Disable Time . . . . . 180ns/35ns (Typ)
- Total Gamma Dose . . . . . 300kRAD(Si)
- Latch Up. . . . . None (DI Technology)

### Applications

- Multiplexed Flash A/D Driver
- RGB Multiplexers/Preamps
- Video Switching and Routing
- Pulse and Video Amplifiers
- Wideband Amplifiers
- RF/IF Signal Processing
- Imaging Systems

### Pinout

HS-1145RH  
GDIP1-T8 (CERDIP)  
OR CDIP2-T8 (SBDIP)  
TOP VIEW

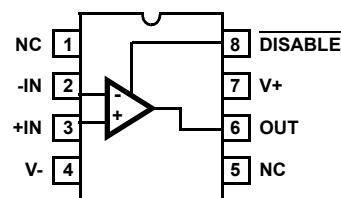

## Application Information

### Optimum Feedback Resistor

Although a current feedback amplifier's bandwidth dependency on closed loop gain isn't as severe as that of a voltage feedback amplifier, there can be an appreciable decrease in bandwidth at higher gains. This decrease may be minimized by taking advantage of the current feedback amplifier's unique relationship between bandwidth and  $R_F$ . All current feedback amplifiers require a feedback resistor, even for unity gain applications, and  $R_F$ , in conjunction with the internal compensation capacitor, sets the dominant pole of the frequency response. Thus, the amplifier's bandwidth is inversely proportional to  $R_F$ . The HS-1145RH design is optimized for  $R_F = 510\Omega$  at a gain of +2. Decreasing  $R_F$  decreases stability, resulting in excessive peaking and overshoot (Note: Capacitive feedback will cause the same problems due to the feedback impedance decrease at higher frequencies). At higher gains, however, the amplifier is more stable so  $R_F$  can be decreased in a trade-off of stability for bandwidth.

The table below lists recommended  $R_F$  values for various gains, and the expected bandwidth. For a gain of +1, a resistor (+ $R_S$ ) in series with +IN is required to reduce gain peaking and increase stability.

GAIN ( $A_{CL}$ )	$R_F$ ( $\Omega$ )	BANDWIDTH (MHz)
-1	425	300
+1	510 (+ $R_S = 510\Omega$ )	270
+2	510	330
+5	200	300
+10	180	130

### Non-Inverting Input Source Impedance

For best operation, the DC source impedance seen by the non-inverting input should be  $\geq 50\Omega$ . This is especially important in inverting gain configurations where the non-inverting input would normally be connected directly to GND.

### DISABLE Input TTL Compatibility

The HS-1145RH derives an internal GND reference for the digital circuitry as long as the power supplies are symmetrical about GND. With symmetrical supplies the digital switching threshold ( $V_{TH} = (V_{IH} + V_{IL})/2 = (2.0 + 0.8)/2$ ) is 1.4V, which ensures the TTL compatibility of the **DISABLE** input. If asymmetrical supplies (e.g., +10V, 0V) are utilized, the switching threshold becomes:

$$V_{TH} = \frac{V_+ + V_-}{2} + 1.4V$$

and the  $V_{IH}$  and  $V_{IL}$  levels will be  $V_{TH} \pm 0.6V$ , respectively.

### Optional GND Pad (Die Use Only) for TTL Compatibility

The die version of the HS-1145RH provides the user with a GND pad for setting the disable circuitry GND reference. With symmetrical supplies the GND pad may be left unconnected, or tied directly to GND. If asymmetrical supplies (e.g., +10V, 0V) are utilized, and TTL compatibility is desired, die users must connect the GND pad to GND. With an external GND, the **DISABLE** input is TTL compatible regardless of supply voltage utilized.

### Pulse Undershoot and Asymmetrical Slew Rates

The HS-1145RH utilizes a quasi-complementary output stage to achieve high output current while minimizing quiescent supply current. In this approach, a composite device replaces the traditional PNP pulldown transistor. The composite device switches modes after crossing 0V, resulting in added distortion for signals swinging below ground, and an increased undershoot on the negative portion of the output waveform (See Figures 5, 8, and 11). This undershoot isn't present for small bipolar signals, or large positive signals. Another artifact of the composite device is asymmetrical slew rates for output signals with a negative voltage component. The slew rate degrades as the output signal crosses through 0V (See Figures 5, 8, and 11), resulting in a slower overall negative slew rate. Positive only signals have symmetrical slew rates as illustrated in the large signal positive pulse response graphs (See Figures 4, 7, and 10).

### PC Board Layout

This amplifier's frequency response depends greatly on the care taken in designing the PC board. **The use of low inductance components such as chip resistors and chip capacitors is strongly recommended, while a solid ground plane is a must!**

Attention should be given to decoupling the power supplies. A large value (10 $\mu$ F) tantalum in parallel with a small value (0.1 $\mu$ F) chip capacitor works well in most cases.

Terminated microstrip signal lines are recommended at the device's input and output connections. Capacitance, parasitic or planned, connected to the output must be minimized, or isolated as discussed in the next section.

Care must also be taken to minimize the capacitance to ground at the amplifier's inverting input (-IN), as this capacitance causes gain peaking, pulse overshoot, and if large enough, instability. To reduce this capacitance, the designer should remove the ground plane under traces connected to -IN, and keep connections to -IN as short as possible.

An example of a good high frequency layout is the Evaluation Board shown in Figure 2.

### Driving Capacitive Loads

Capacitive loads, such as an A/D input, or an improperly terminated transmission line will degrade the amplifier's phase margin resulting in frequency response peaking and possible oscillations. In most cases, the oscillation can be avoided by placing a resistor ( $R_S$ ) in series with the output prior to the capacitance.

Figure 1 details starting points for the selection of this resistor. The points on the curve indicate the  $R_S$  and  $C_L$  combinations for the optimum bandwidth, stability, and settling time, but experimental fine tuning is recommended. Picking a point above or to the right of the curve yields an overdamped response, while points below or left of the curve indicate areas of underdamped performance.

$R_S$  and  $C_L$  form a low pass network at the output, thus limiting system bandwidth well below the amplifier bandwidth of 270MHz (for  $A_V = +1$ ). By decreasing  $R_S$  as  $C_L$  increases (as illustrated in the curves), the maximum bandwidth is obtained without sacrificing stability. In spite of this, the bandwidth decreases as the load capacitance increases. For example, at  $A_V = +1$ ,  $R_S = 62\Omega$ ,  $C_L = 40\text{pF}$ , the overall bandwidth is limited to 180MHz, and bandwidth drops to 75MHz at  $A_V = +1$ ,  $R_S = 8\Omega$ ,  $C_L = 400\text{pF}$ .

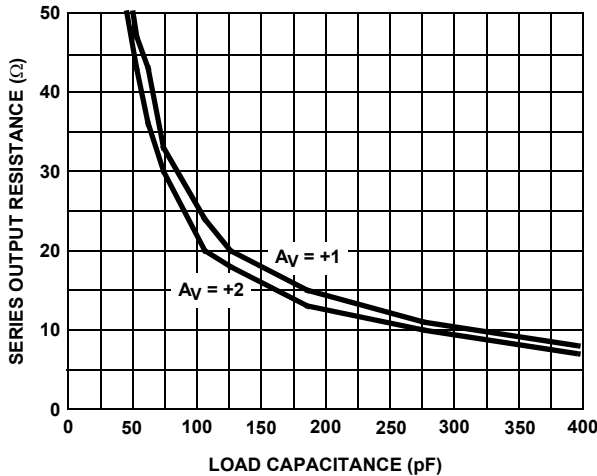

FIGURE 1. RECOMMENDED SERIES OUTPUT RESISTOR vs LOAD CAPACITANCE

### Evaluation Board

The performance of the HS-1145RH may be evaluated using the HFA11XX Evaluation Board.

The layout and schematic of the board are shown in Figure 2. The  $V_H$  connection may be used to exercise the  $\overline{\text{DISABLE}}$  pin, but note that this connection has no 50Ω termination. To order evaluation boards (part number HFA11XXEVAL), please contact your local sales office.

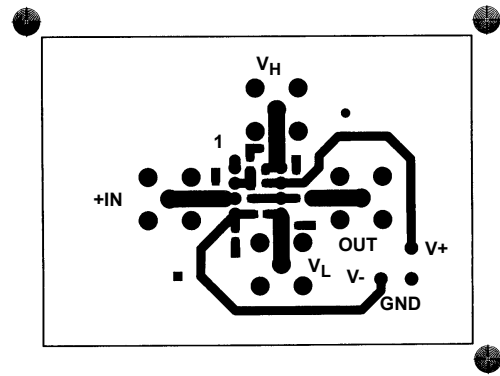

FIGURE 2A. TOP LAYOUT

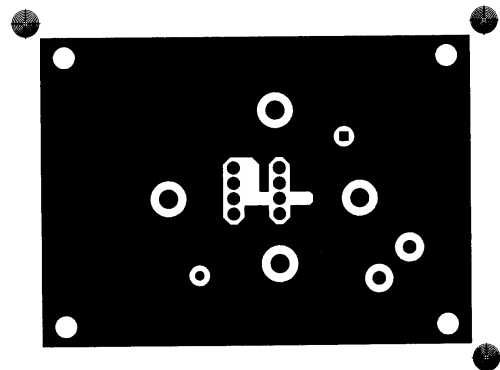

FIGURE 2B. BOTTOM LAYOUT

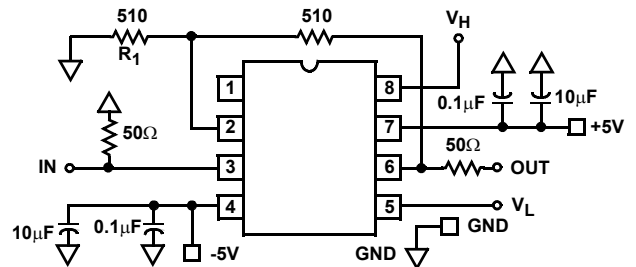

FIGURE 2C. SCHEMATIC

FIGURE 2. EVALUATION BOARD SCHEMATIC AND LAYOUT

**Typical Performance Curves**  $V_{SUPPLY} = \pm 5V$ ,  $R_F = 510\Omega$ ,  $T_A = 25^\circ C$ ,  $R_L = 100\Omega$ , Unless Otherwise Specified

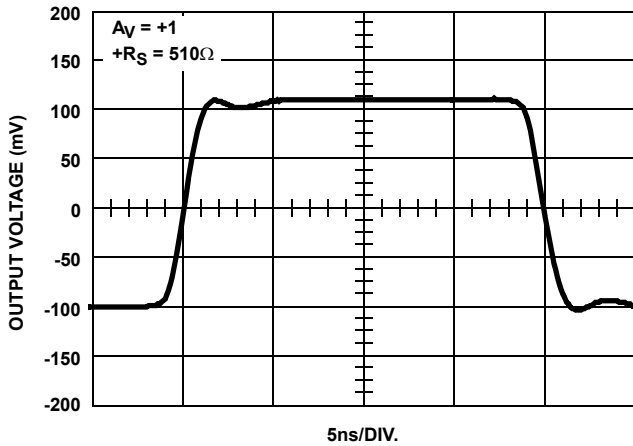

FIGURE 3. SMALL SIGNAL PULSE RESPONSE

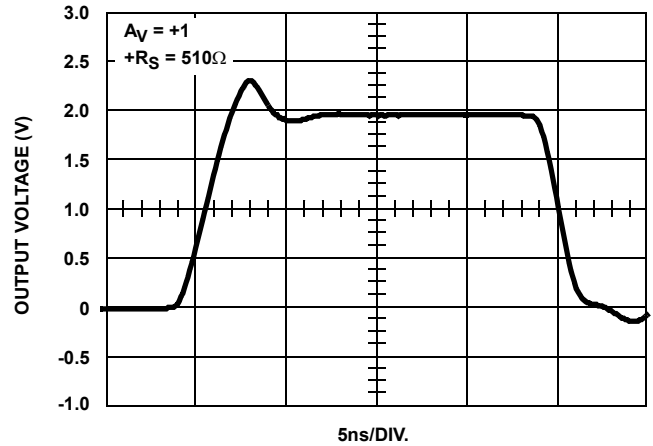

FIGURE 4. LARGE SIGNAL POSITIVE PULSE RESPONSE

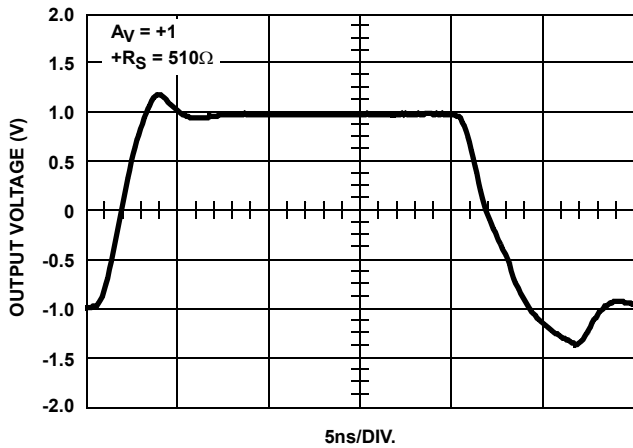

FIGURE 5. LARGE SIGNAL BIPOLAR PULSE RESPONSE

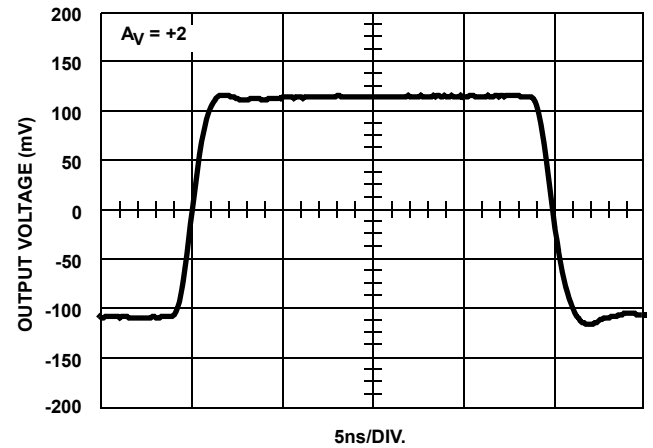

FIGURE 6. SMALL SIGNAL PULSE RESPONSE

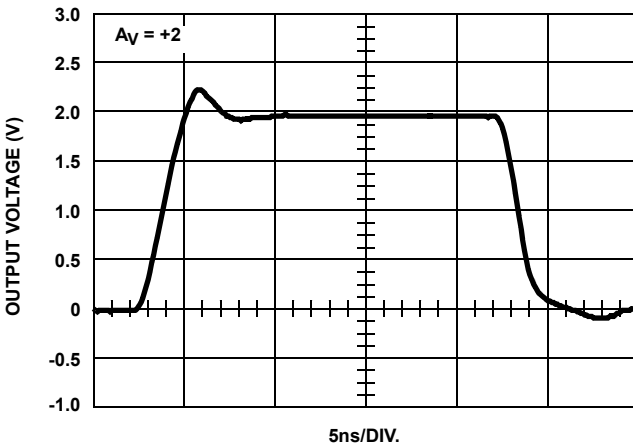

FIGURE 7. LARGE SIGNAL POSITIVE PULSE RESPONSE

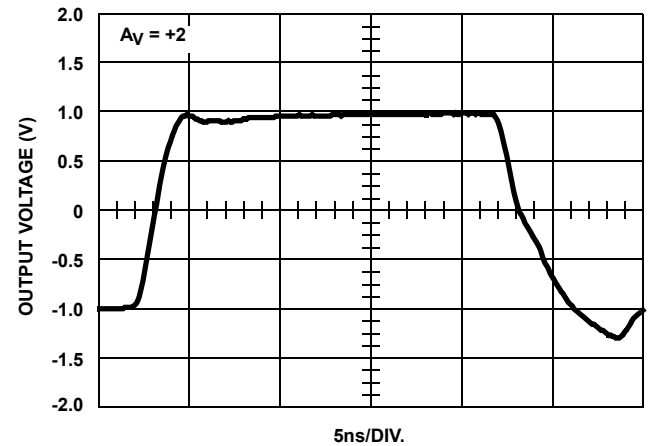

FIGURE 8. LARGE SIGNAL BIPOLAR PULSE RESPONSE

**Typical Performance Curves**  $V_{SUPPLY} = \pm 5V$ ,  $R_F = 510\Omega$ ,  $T_A = 25^\circ C$ ,  $R_L = 100\Omega$ , Unless Otherwise Specified (Continued)

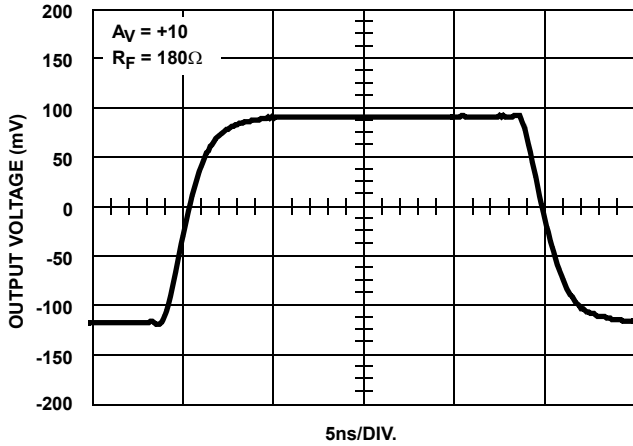

FIGURE 9. SMALL SIGNAL PULSE RESPONSE

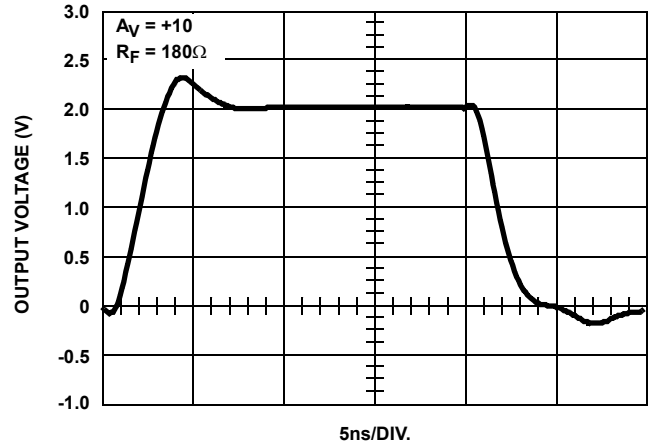

FIGURE 10. LARGE SIGNAL POSITIVE PULSE RESPONSE

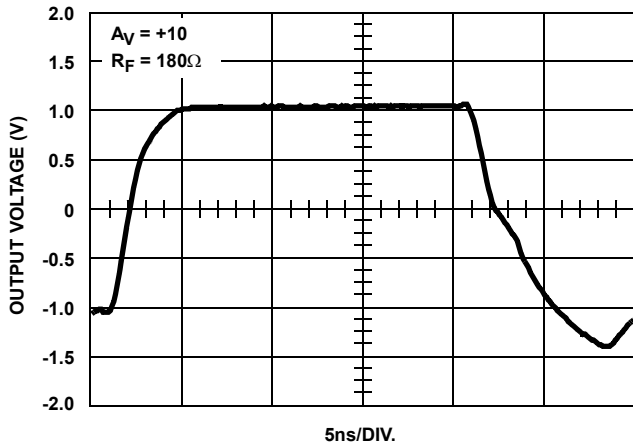

FIGURE 11. LARGE SIGNAL BIPOLAR PULSE RESPONSE

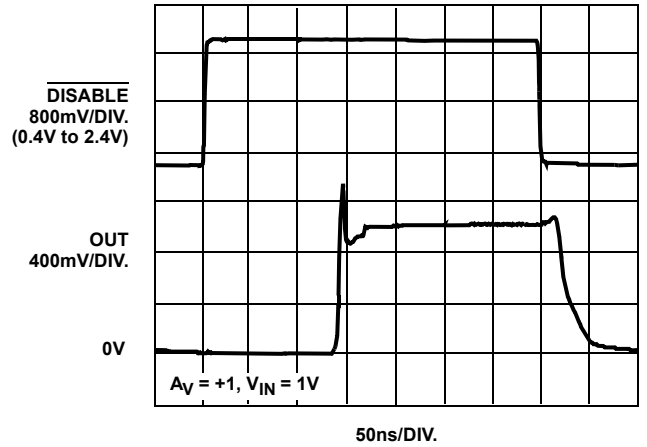

FIGURE 12. OUTPUT ENABLE AND DISABLE RESPONSE

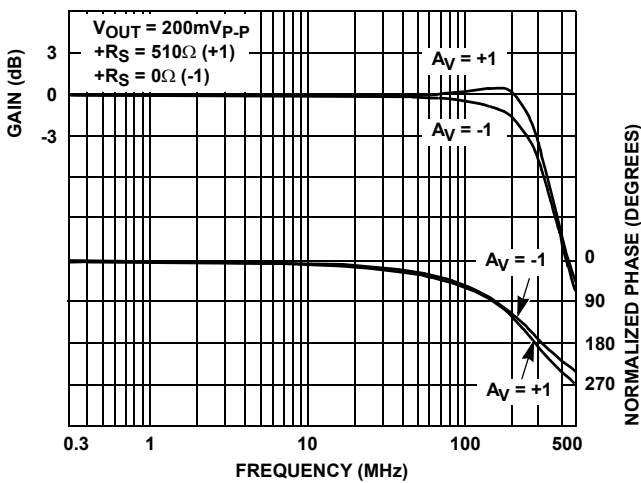

FIGURE 13. FREQUENCY RESPONSE

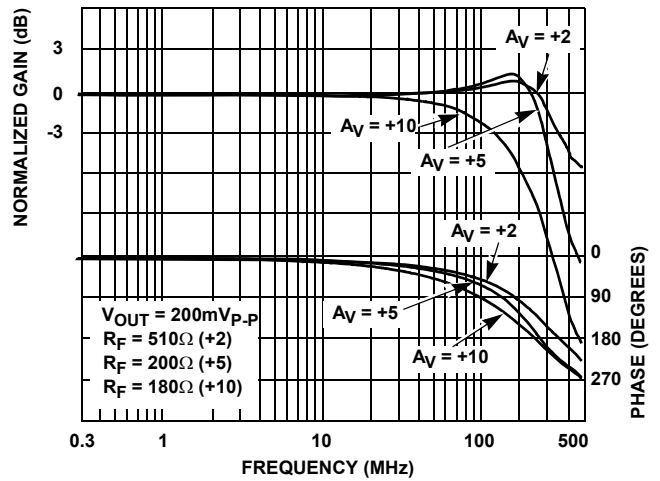

FIGURE 14. FREQUENCY RESPONSE

**Typical Performance Curves**  $V_{SUPPLY} = \pm 5V$ ,  $R_F = 510\Omega$ ,  $T_A = 25^\circ C$ ,  $R_L = 100\Omega$ , Unless Otherwise Specified (Continued)

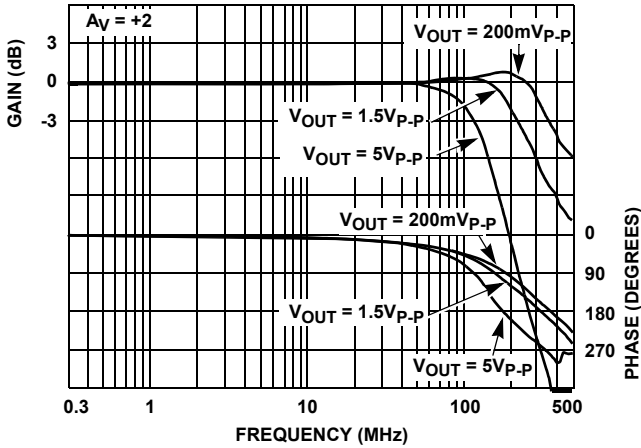

FIGURE 15. FREQUENCY RESPONSE FOR VARIOUS OUTPUT VOLTAGES

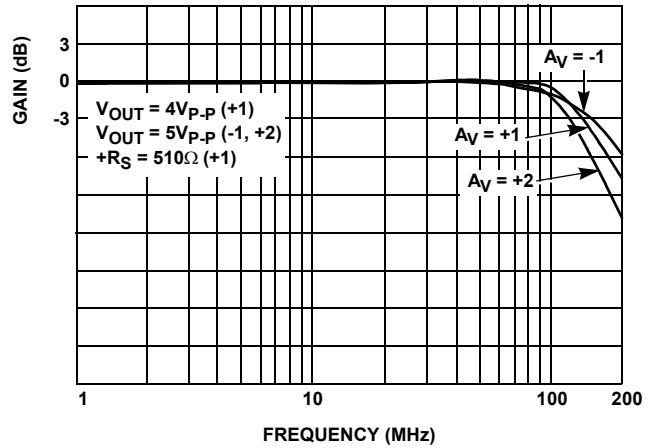

FIGURE 16. FULL POWER BANDWIDTH

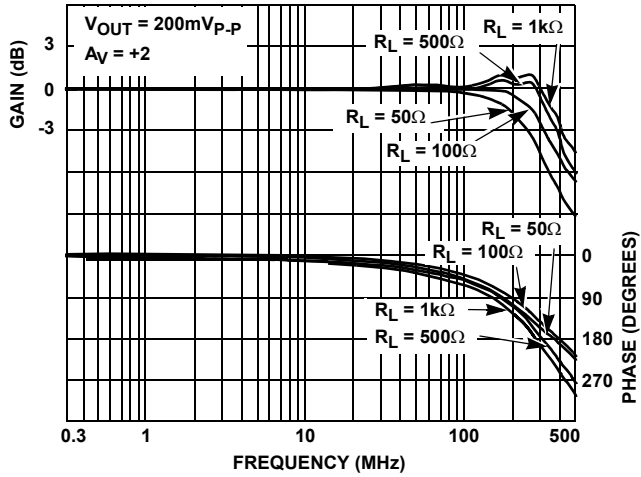

FIGURE 17. FREQUENCY RESPONSE FOR VARIOUS LOAD RESISTORS

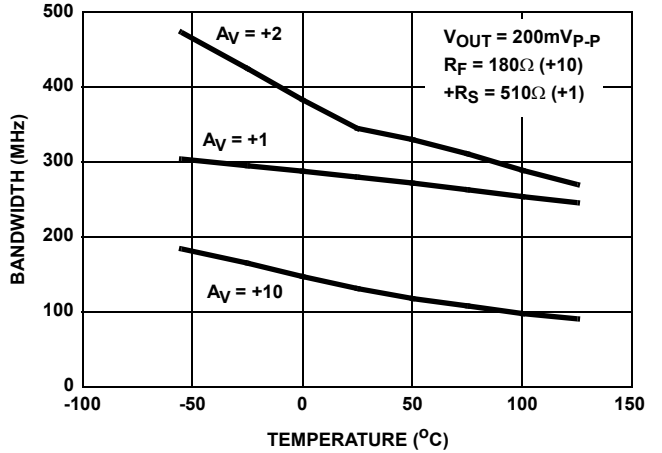

FIGURE 18. -3dB BANDWIDTH vs TEMPERATURE

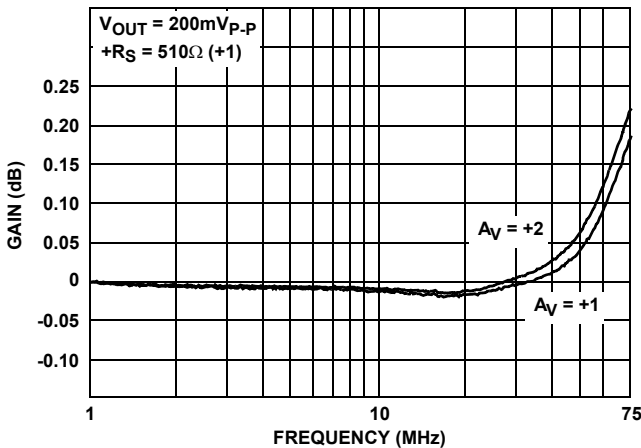

FIGURE 19. GAIN FLATNESS

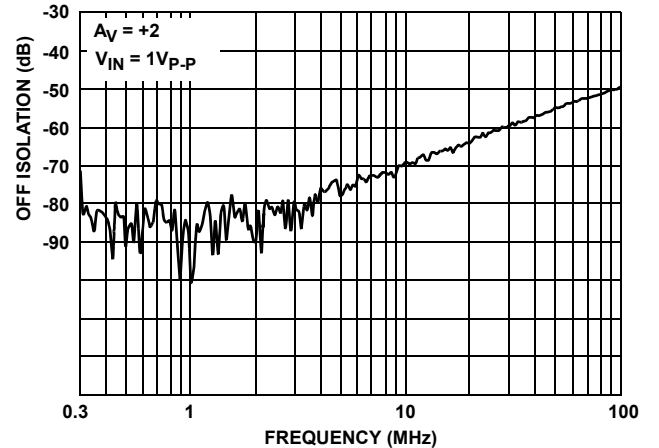

FIGURE 20. OFF ISOLATION

**Typical Performance Curves**  $V_{SUPPLY} = \pm 5V$ ,  $R_F = 510\Omega$ ,  $T_A = 25^\circ C$ ,  $R_L = 100\Omega$ , Unless Otherwise Specified (Continued)

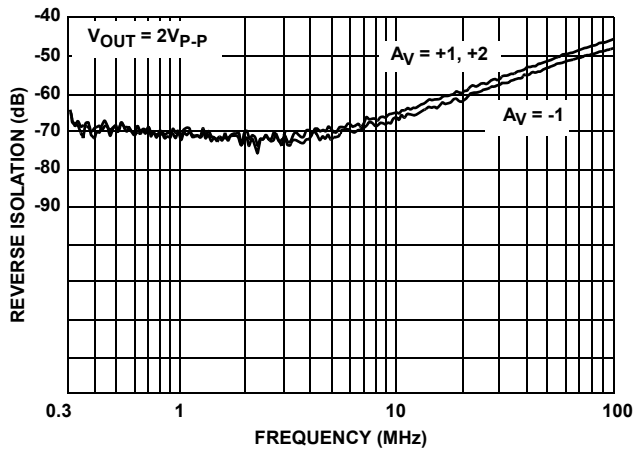

FIGURE 21. REVERSE ISOLATION

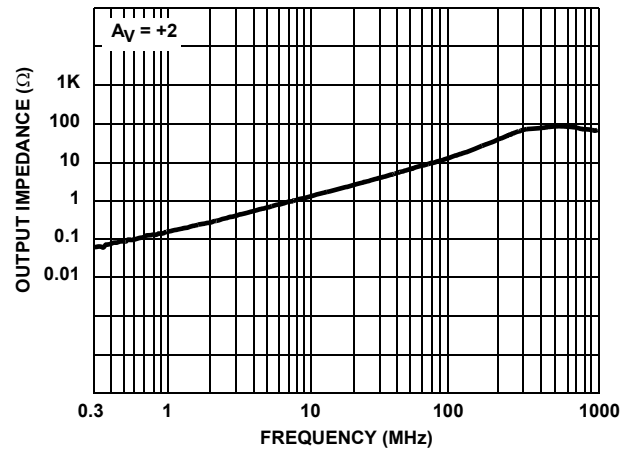

FIGURE 22. ENABLED OUTPUT IMPEDANCE

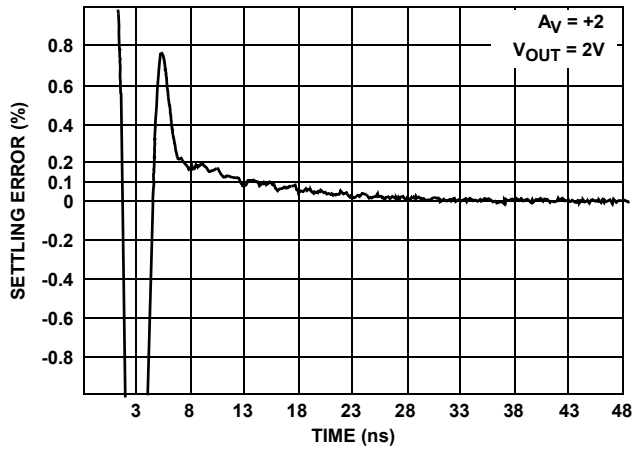

FIGURE 23. SETTLING RESPONSE

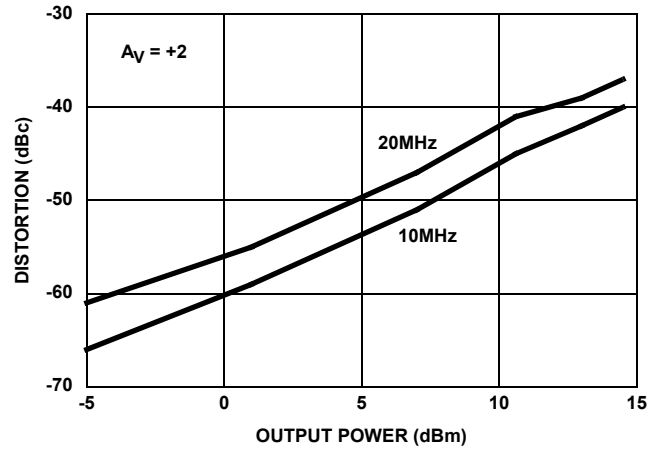

FIGURE 24. SECOND HARMONIC DISTORTION vs  $P_{OUT}$

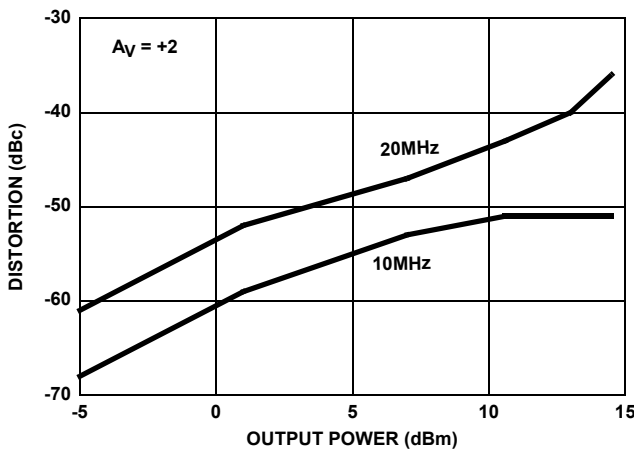

FIGURE 25. THIRD HARMONIC DISTORTION vs  $P_{OUT}$

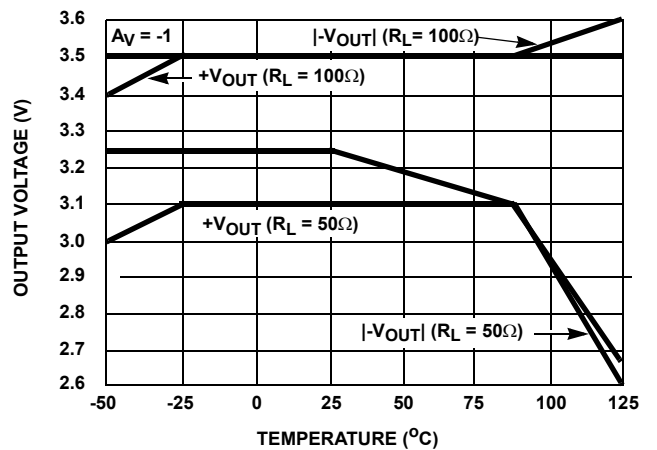

FIGURE 26. OUTPUT VOLTAGE vs TEMPERATURE

**Typical Performance Curves**  $V_{SUPPLY} = \pm 5V$ ,  $R_F = 510\Omega$ ,  $T_A = 25^\circ C$ ,  $R_L = 100\Omega$ , Unless Otherwise Specified (Continued)

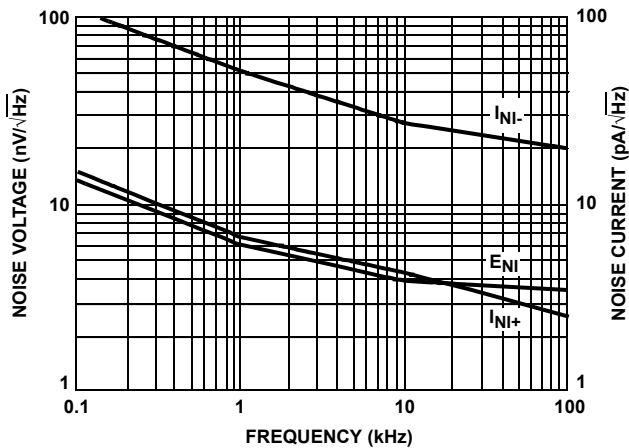

FIGURE 27. INPUT NOISE CHARACTERISTICS

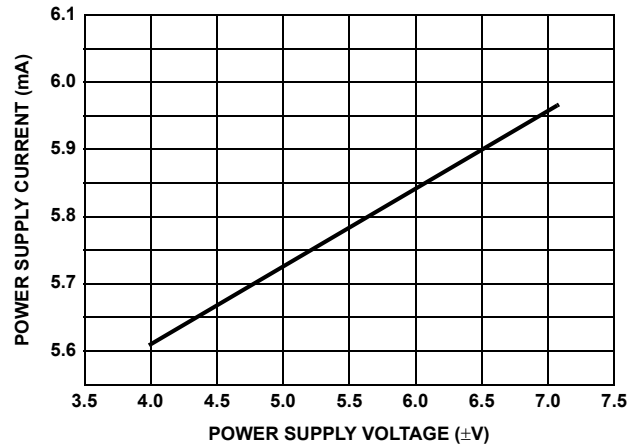
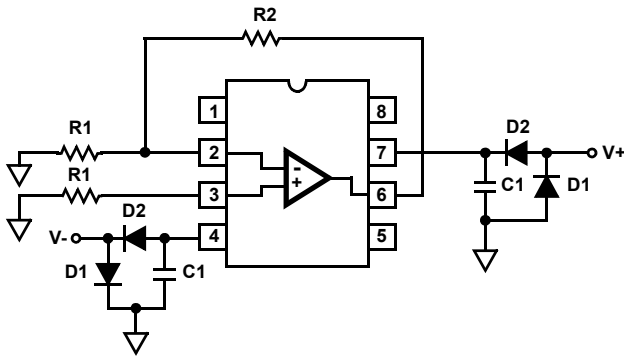

FIGURE 28. SUPPLY CURRENT vs SUPPLY VOLTAGE

**Burn-In Circuit**

HS-1145RH CERDIP



NOTES:

1. R1 = 1kΩ, ±5% (Per Socket)
2. R2 = 10kΩ, ±5% (Per Socket)
3. C1 = 0.01μF (Per Socket) or 0.1μF (Per Row) Minimum
4. D1 = 1N4002 or Equivalent (Per Board)
5. D2 = 1N4002 or Equivalent (Per Socket)
6. V+ = +5.5V ± 0.5V
7. V- = -5.5V ± 0.5V

**Irradiation Circuit**

HS-1145RH CERDIP

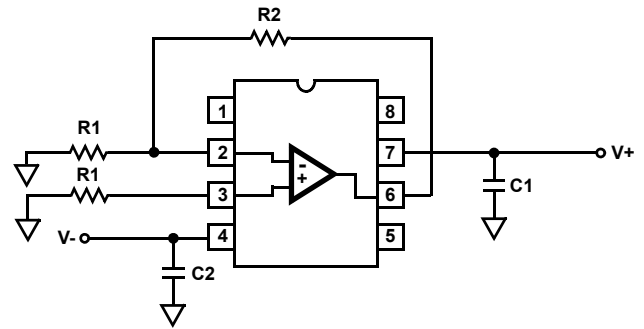

NOTES:

8. R1 = 1kΩ, ±5%
9. R2 = 10kΩ, ±5%
10. C1 = C2 = 0.01μF
11. V+ = +5.0V ± 0.5V
12. V- = -5.0V ± 0.5V

© Copyright Intersil Americas LLC 1999-2005. All Rights Reserved.

All trademarks and registered trademarks are the property of their respective owners.

For additional products, see [www.intersil.com/en/products.html](http://www.intersil.com/en/products.html)

Intersil products are manufactured, assembled and tested utilizing ISO9001 quality systems as noted in the quality certifications found at [www.intersil.com/en/support/qualandreliability.html](http://www.intersil.com/en/support/qualandreliability.html)

Intersil products are sold by description only. Intersil may modify the circuit design and/or specifications of products at any time without notice, provided that such modification does not, in Intersil's sole judgment, affect the form, fit or function of the product. Accordingly, the reader is cautioned to verify that datasheets are current before placing orders. Information furnished by Intersil is believed to be accurate and reliable. However, no responsibility is assumed by Intersil or its subsidiaries for its use; nor for any infringements of patents or other rights of third parties which may result from its use. No license is granted by implication or otherwise under any patent or patent rights of Intersil or its subsidiaries.

For information regarding Intersil Corporation and its products, see [www.intersil.com](http://www.intersil.com)



### Die Characteristics

**DIE DIMENSIONS:**

59 mils x 59 mils x 14 mils ±1 mil  
(1500µm x 1500µm x 483µm ± 25.4µm)

**INTERFACE MATERIALS:**

**Glassivation:**

Type: Nitride  
Thickness: 4kÅ ±0.5kÅ

**Top Metallization:**

Type: Metal 1: AlCu(2%)/TiW  
Thickness: Metal 1: 8kÅ ±0.4kÅ  
Type: Metal 2: AlCu(2%)  
Thickness: Metal 2: 16kÅ ±0.8kÅ

**Substrate:**

UHF-1, Bonded Wafer, DI

**ASSEMBLY RELATED INFORMATION:**

**Substrate Potential:**

Floating (Recommend Connection to V-)

**ADDITIONAL INFORMATION:**

**Transistor Count:**

75

### Metallization Mask Layout

HS-1145RH

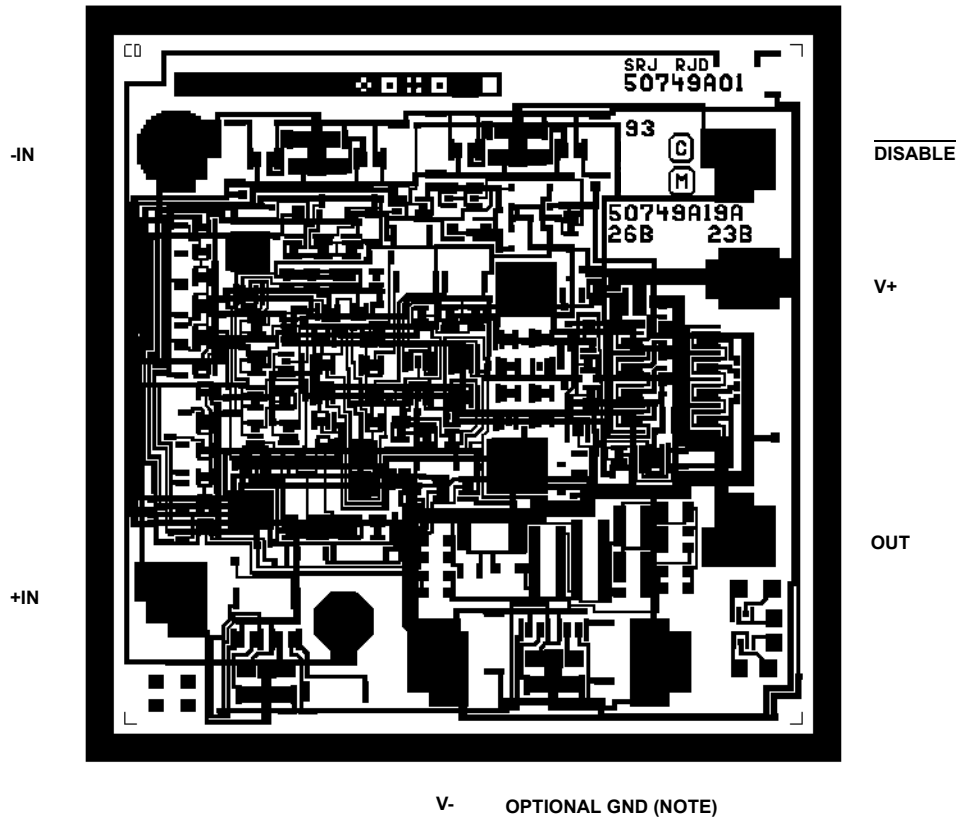

NOTE: This pad is not bonded out on packaged units. Die users may set a GND reference, via this pad, to ensure the TTL compatibility of the  $\overline{DIS}$  input when using asymmetrical supplies (e.g. V+ = 10V, V- = 0V). See the "Application Information" section for details.