

FEATURES:

- 2.3V to 2.7V Operation
- SSTL\_2 Class I style data inputs/outputs
- Differential CLK input
- $\overline{\text{RESET}}$  control compatible with LVC MOS levels
- Flow-through architecture for optimum PCB design
- Drive up to equivalent of 14 SDRAM loads
- Latch-up performance exceeds 100mA
- ESD >2000V per MIL-STD-883, Method 3015; >200V using machine model (C = 200pF, R = 0)
- Available in TSSOP package

APPLICATIONS:

- Along with CSPT857C, Zero Delay PLL Clock buffer, provides complete solution for DDR1 DIMMs

DESCRIPTION:

The SSTVF16857 is a 14-bit registered buffer designed for 2.3V-2.7V  $V_{DD}$  and supports low standby operation. All data inputs and outputs are SSTL\_2 level compatible with JEDEC standard for SSTL\_2.

$\overline{\text{RESET}}$  is an LVC MOS input since it must operate predictably during the power-up phase.  $\overline{\text{RESET}}$ , which can be operated independent of CLK and  $\overline{\text{CLK}}$ , must be held in the low state during power-up in order to ensure predictable outputs (low state) before a stable clock has been applied.

$\overline{\text{RESET}}$ , when in the low state, will disable all input receivers, reset all registers, and force all outputs to a low state, before a stable clock has been applied. With inputs held low and a stable clock applied, outputs will remain low during the Low-to-High transition of  $\overline{\text{RESET}}$ .

FUNCTIONAL BLOCK DIAGRAM

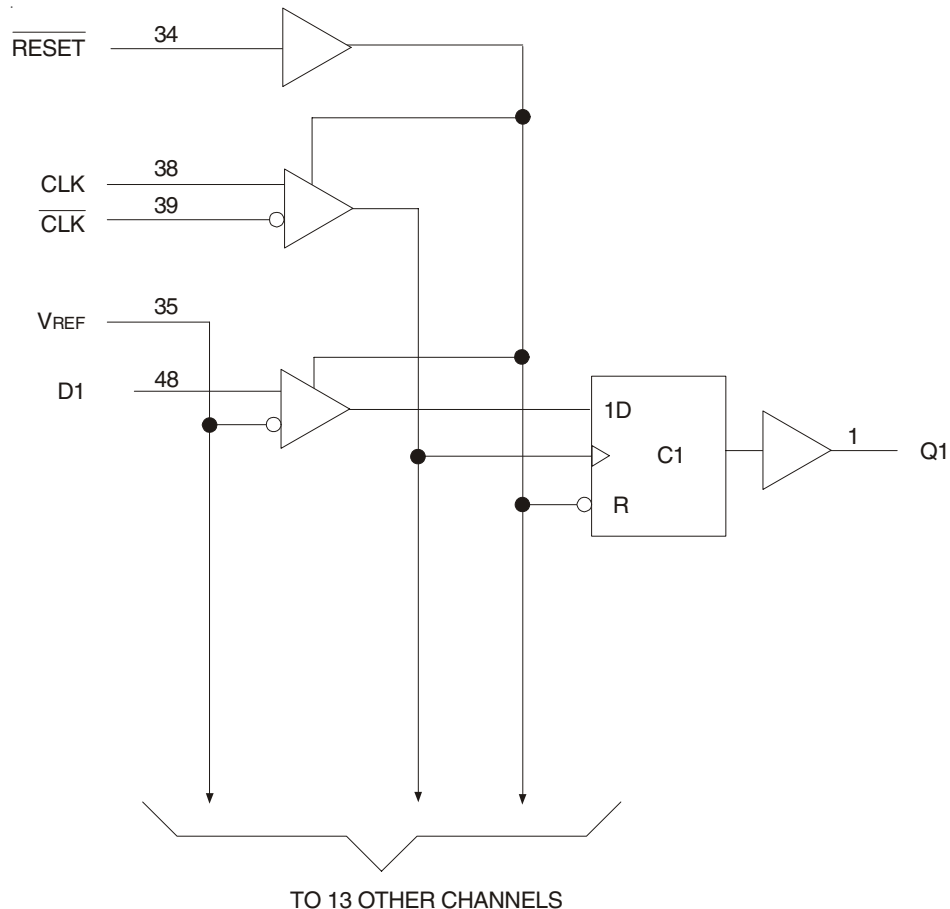

PIN CONFIGURATION

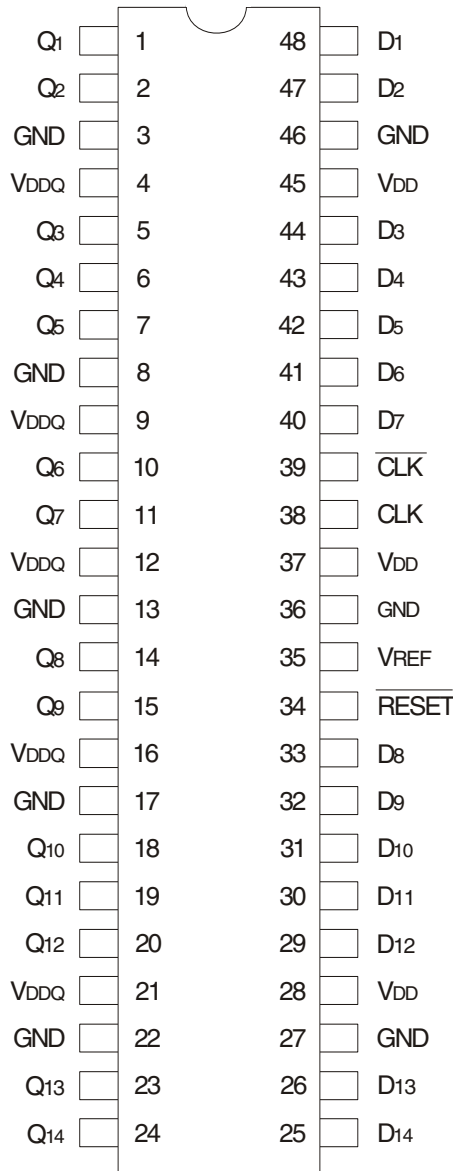

TSSOP  
TOP VIEW

ABSOLUTE MAXIMUM RATINGS (1)

| Symbol                        | Description   | Max.               | Unit |
|-------------------------------|---|--------------------|------|
| VDD or VDDQ                   | Supply Voltage Range  | -0.5 to 3.6        | V    |
| V <sub>I</sub> <sup>(2)</sup> | Input Voltage Range   | -0.5 to VDD + 0.5  | V    |
| V <sub>O</sub> <sup>(3)</sup> | Output Voltage Range  | -0.5 to VDDQ + 0.5 | V    |
| I <sub>IK</sub>               | Input Clamp Current, V <sub>I</sub> < 0                           | -50                | mA   |
| I <sub>OK</sub>               | Output Clamp Current, V <sub>O</sub> < 0 or V <sub>O</sub> > VDDQ | ±50                | mA   |
| I <sub>O</sub>                | Continuous Output Current, V <sub>O</sub> = 0 to VDDQ             | ±50                | mA   |
| VDD                           | Continuous Current through each VDD, VDDQ or GND                  | ±100               | mA   |
| T <sub>STG</sub>              | Storage Temperature Range   | -65 to +150        | °C   |

NOTES:

- Stresses greater than those listed under ABSOLUTE MAXIMUM RATINGS may cause permanent damage to the device. This is a stress rating only and functional operation of the device at these or any other conditions above those indicated in the operational sections of this specification is not implied. Exposure to absolute maximum rating conditions for extended periods may affect reliability.
- The input and output negative voltage ratings may be exceeded if the ratings of the I/P and O/P clamp current are observed.
- The output current will flow if the following conditions are observed:
  - Output in HIGH state
  - V<sub>O</sub> = VDDQ

FUNCTION TABLE (1)

| Input |        |        |   | Q Outputs                     |
|-------|--------|--------|---|-------------------------------|
| RESET | CLK    | CLK    | D |                               |
| H     | ↑      | ↓      | L | L                             |
| H     | ↑      | ↓      | H | H                             |
| H     | L or H | L or H | X | Q <sub>0</sub> <sup>(2)</sup> |
| L     | X      | X      | X | L                             |

NOTES:

- H = HIGH Voltage Level  
L = LOW Voltage Level  
X = Don't Care  
↑ = LOW to HIGH  
↓ = HIGH to LOW
- Q<sub>0</sub> = Output level before the indicated steady-state conditions were established.

## DC ELECTRICAL CHARACTERISTICS OVER OPERATING RANGE

Following Conditions Apply Unless Otherwise Specified:

Operating Condition:  $T_A = 0^\circ\text{C}$  to  $+70^\circ\text{C}$ ,  $V_{DD} = 2.5\text{V} \pm 0.2\text{V}$ ,  $V_{DDQ} = 2.5\text{V} \pm 0.2\text{V}$

| Symbol   | Parameter                               | Test Conditions   | Min.           | Typ. | Max.    | Unit                              |
|----------|---|---|----------------|------|---------|-----------------------------------|
| $V_{IK}$ | Control Inputs                          | $V_{DD} = 2.3\text{V}$ , $I_I = -18\text{mA}$   | —              | —    | -1.2    | V                                 |
| $V_{OH}$ |   | $V_{DD} = 2.3\text{V}$ to $2.7\text{V}$ , $I_{OH} = -100\mu\text{A}$  | $V_{DD} - 0.2$ | —    | —       | V                                 |
|          |   | $V_{DD} = 2.3\text{V}$ , $I_{OH} = -8\text{mA}$   | 1.95           | —    | —       |                                   |
| $V_{OL}$ |   | $V_{DD} = 2.3\text{V}$ to $2.7\text{V}$ , $I_{OL} = 100\mu\text{A}$   | —              | —    | 0.2     | V                                 |
|          |   | $V_{DD} = 2.3\text{V}$ , $I_{OL} = 8\text{mA}$  | —              | —    | 0.35    |                                   |
| $I_I$    | All Inputs                              | $V_{DD} = 2.7\text{V}$ , $V_I = V_{DD}$ or GND  | —              | —    | $\pm 5$ | $\mu\text{A}$                     |
| $I_{DD}$ | Static Standby                          | $I_O = 0$ , $V_{DD} = 2.7\text{V}$ , $\overline{\text{RESET}} = \text{GND}$   | —              | —    | 0.01    | mA                                |
|          | Static Operating                        | $I_O = 0$ , $V_{DD} = 2.7\text{V}$ , $\overline{\text{RESET}} = V_{DD}$ , $V_I = V_{IH}$ (AC) or $V_{IL}$ (AC)  | —              | 6    | —       |                                   |
| $I_{DD}$ | Dynamic Operating (Clock Only)          | $I_O = 0$ , $V_{DD} = 2.7\text{V}$ , $\overline{\text{RESET}} = V_{DD}$ , $V_I = V_{IH}$ (AC) or $V_{IL}$ (AC), CLK and $\overline{\text{CLK}}$ Switching 50% Duty Cycle.   | —              | —    | —       | $\mu\text{A}/\text{Clock}$<br>MHz |
|          | Dynamic Operating (Per Each Data Input) | $I_O = 0$ , $V_{DD} = 2.7\text{V}$ , $\overline{\text{RESET}} = V_{DD}$ , $V_I = V_{IH}$ (AC) or $V_{IL}$ (AC), CLK and $\overline{\text{CLK}}$ Switching 50% Duty Cycle. One Data Input Switching at Half Clock Frequency, 50% Duty Cycle. | —              | —    | —       |                                   |
| $C_I$    | Data Inputs                             | $V_{DD} = 2.5\text{V}$ , $V_I = V_{REF} \pm 310\text{mV}$   | 2.5            | —    | 3.5     | pF                                |
|          | CLK and $\overline{\text{CLK}}$         | $V_{ICR} = 1.25\text{V}$ , $V_I(\text{PP}) = 360\text{mV}$  | 2.5            | —    | 3.5     |                                   |
|          | $\overline{\text{RESET}}$               | $V_I = V_{DD}$ or GND   | —              | —    | —       |                                   |

## OPERATING CHARACTERISTICS, $T_A = 25^\circ\text{C}$ (1)

| Symbol           | Parameter                                   | Min.                         | Typ. <sup>(1)</sup>      | Max.                     | Unit             |    |
|------------------|---|------------------------------|--------------------------|--------------------------|------------------|----|
| $V_{DD}$         | Supply Voltage                              | $V_{DDQ}$                    | —                        | 2.7                      | V                |    |
| $V_{DDQ}$        | Output Supply Voltage                       | 2.3                          | 2.5                      | 2.7                      | V                |    |
| $V_{REF}$        | Reference Voltage ( $V_{REF} = V_{DDQ}/2$ ) | 1.15                         | 1.25                     | 1.35                     | V                |    |
| $V_{TT}$         | Termination Voltage                         | $V_{REF} - 40\text{mV}$      | $V_{REF}$                | $V_{REF} + 40\text{mV}$  | V                |    |
| $V_I$            | Input Voltage                               | 0                            | —                        | $V_{DD}$                 | V                |    |
| $V_{IH}$         | AC High-Level Input Voltage                 | Data Inputs                  | $V_{REF} + 310\text{mV}$ | —                        | V                |    |
| $V_{IL}$         | AC Low-Level Input Voltage                  | Data Inputs                  | —                        | $V_{REF} - 310\text{mV}$ | V                |    |
| $V_{IH}$         | DC High-Level Input Voltage                 | Data Inputs                  | $V_{REF} + 150\text{mV}$ | —                        | V                |    |
| $V_{IL}$         | DC Low-Level Input Voltage                  | Data Inputs                  | —                        | $V_{REF} - 150\text{mV}$ | V                |    |
| $V_{IH}$         | High-Level Input Voltage                    | $\overline{\text{RESET}}$    | 1.7                      | —                        | V                |    |
| $V_{IL}$         | Low-Level Input Voltage                     | $\overline{\text{RESET}}$    | —                        | 0.7                      | V                |    |
| $V_{ICR}$        | Common-Mode Input Range                     | CLK, $\overline{\text{CLK}}$ | 0.97                     | —                        | 1.53             | V  |
| $V_I(\text{PP})$ | Peak-to-Peak Input Voltage                  | CLK, $\overline{\text{CLK}}$ | 360                      | —                        | —                | mV |
| $I_{OH}$         | High-Level Output Current                   |                              | —                        | —                        | -20              | mA |
| $I_{OL}$         | Low-Level Output Current                    |                              | —                        | —                        | 20               |    |
| $T_A$            | Operating Free-Air Temperature              | 0                            | —                        | +70                      | $^\circ\text{C}$ |    |

NOTE:

- The  $\overline{\text{RESET}}$  input of the device must be held at  $V_{DD}$  or GND to ensure proper device operation.

## TIMING REQUIREMENTS OVER RECOMMENDED OPERATING FREE-AIR TEMPERATURE RANGE

| Symbol             | Parameter  | V <sub>DD</sub> = 2.5V ± 0.2V |      | Unit |    |
|--------------------|--|-------------------------------|------|------|----|
|                    |  | Min.                          | Max. |      |    |
| CLOCK              | Clock Frequency  | —                             | 200  | MHz  |    |
| t <sub>w</sub>     | Pulse Duration, CLK, $\overline{\text{CLK}}$ HIGH or LOW | 2.5                           | —    | ns   |    |
| t <sub>ACT</sub>   | Differential Inputs Active Time <sup>(1)</sup>           | —                             | 22   | ns   |    |
| t <sub>INACT</sub> | Differential Inputs Inactive Time <sup>(2)</sup>         | —                             | 22   | ns   |    |
| t <sub>SU</sub>    | Setup Time, Fast Slew Rate <sup>(3,5)</sup>              | Data Before CLK↑, CLK↓        | 0.75 | —    | ns |
|                    | Setup Time, Slow Slew Rate <sup>(4,5)</sup>              |                               | 0.9  | —    | ns |
| t <sub>H</sub>     | Hold Time, Fast Slew Rate <sup>(3,5)</sup>               | Data Before CLK↑, CLK↓        | 0.75 | —    | ns |
|                    | Hold Time, Slow Slew Rate <sup>(2,5)</sup>               |                               | 0.9  | —    | ns |

NOTES:

1. Data inputs must be low a minimum time of t<sub>ACT</sub> max., after  $\overline{\text{RESET}}$  is taken HIGH.
2. Data and clock inputs must be held at valid levels (not floating) a minimum time of t<sub>INACT</sub> max., after  $\overline{\text{RESET}}$  is taken LOW.
3. For data signal input slew rate is ≥1V/ns.
4. For data signal input slew rate is ≥0.5V/ns and <1V/ns.
5. CLK,  $\overline{\text{CLK}}$  signal input slew rates are ≥1V/ns.

## SWITCHING CHARACTERISTICS OVER RECOMMENDED FREE-AIR OPERATING RANGE (UNLESS OTHERWISE NOTED)

| Symbol           | Parameter                            | V <sub>DD</sub> = 2.5V ± 0.2V |      | Unit |
|------------------|--------------------------------------|-------------------------------|------|------|
|                  |                                      | Min                           | Max. |      |
| f <sub>MAX</sub> |                                      | 200                           | —    | MHz  |
| t <sub>PD</sub>  | CLK and $\overline{\text{CLK}}$ to Q | 1.1                           | 2.8  | ns   |
| t <sub>PHL</sub> | $\overline{\text{RESET}}$ to Q       | —                             | 5    | ns   |

TEST CIRCUITS AND WAVEFORMS ( $V_{DD} = 2.5V \pm 0.2V$ )

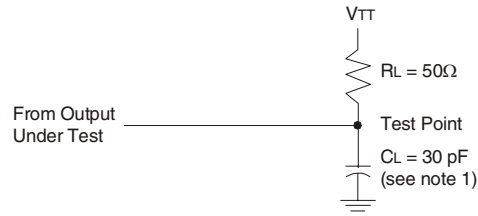

Load Circuit

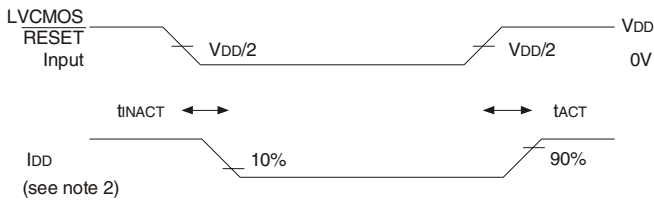

Voltage and Current Waveforms  
Inputs Active and Inactive Times

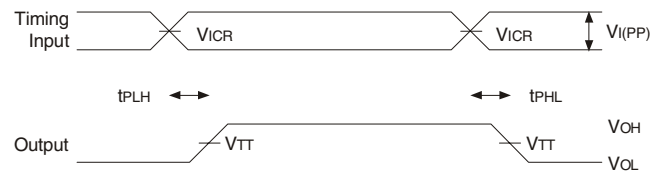

Voltage Waveforms - Propagation Delay Times

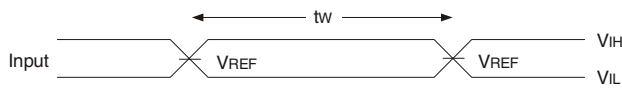

Voltage Waveforms - Pulse Duration

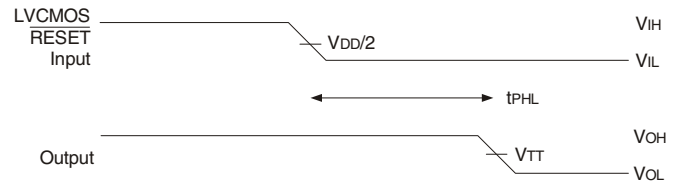

Voltage Waveforms - Propagation Delay Times

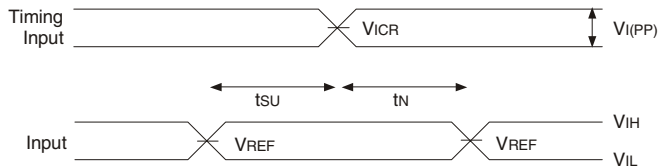

Voltage Waveforms - Setup and Hold Times

NOTES:

1.  $C_L$  includes probe and jig capacitance.
2.  $I_{DD}$  tested with clock and data inputs held at  $V_{DD}$  or GND, and  $I_o = 0\text{ mA}$ .
3. All input pulses are supplied by generators having the following characteristics:  $PRR \leq 10\text{ MHz}$ ,  $Z_o = 50\Omega$ , input slew rate =  $1\text{ V/ns} \pm 20\%$  (unless otherwise specified).
4. The outputs are measured one at a time with one transition per measurement.
5.  $V_{TT} = V_{REF} = V_{DD}/2$
6.  $V_{IH} = V_{REF} + 310\text{ mV}$  (AC voltage levels) for differential inputs.  $V_{IH} = V_{DD}$  for LVC MOS input.
7.  $V_{IL} = V_{REF} - 310\text{ mV}$  (AC voltage levels) for differential inputs.  $V_{IL} = \text{GND}$  for LVC MOS input.
8.  $t_{PLH}$  and  $t_{PHL}$  are the same as  $t_{PD}$ .

## ORDERING INFORMATION

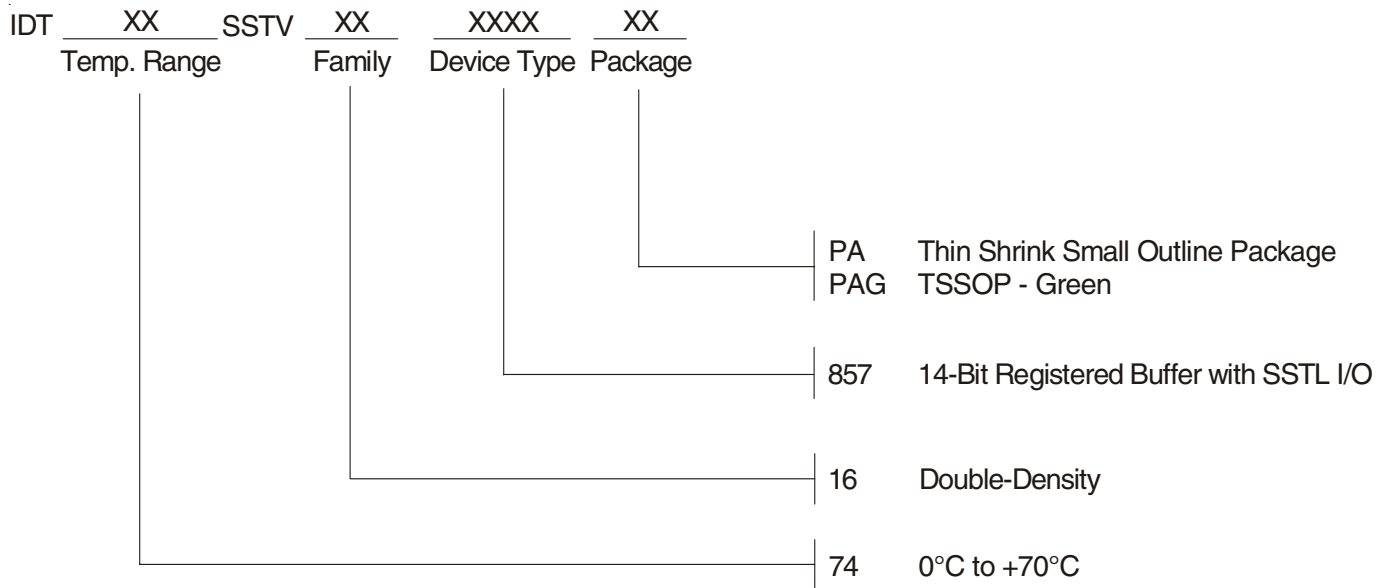

## IMPORTANT NOTICE AND DISCLAIMER

RENESAS ELECTRONICS CORPORATION AND ITS SUBSIDIARIES (“RENESAS”) PROVIDES TECHNICAL SPECIFICATIONS AND RELIABILITY DATA (INCLUDING DATASHEETS), DESIGN RESOURCES (INCLUDING REFERENCE DESIGNS), APPLICATION OR OTHER DESIGN ADVICE, WEB TOOLS, SAFETY INFORMATION, AND OTHER RESOURCES “AS IS” AND WITH ALL FAULTS, AND DISCLAIMS ALL WARRANTIES, EXPRESS OR IMPLIED, INCLUDING, WITHOUT LIMITATION, ANY IMPLIED WARRANTIES OF MERCHANTABILITY, FITNESS FOR A PARTICULAR PURPOSE, OR NON-INFRINGEMENT OF THIRD-PARTY INTELLECTUAL PROPERTY RIGHTS.

These resources are intended for developers who are designing with Renesas products. You are solely responsible for (1) selecting the appropriate products for your application, (2) designing, validating, and testing your application, and (3) ensuring your application meets applicable standards, and any other safety, security, or other requirements. These resources are subject to change without notice. Renesas grants you permission to use these resources only to develop an application that uses Renesas products. Other reproduction or use of these resources is strictly prohibited. No license is granted to any other Renesas intellectual property or to any third-party intellectual property. Renesas disclaims responsibility for, and you will fully indemnify Renesas and its representatives against, any claims, damages, costs, losses, or liabilities arising from your use of these resources. Renesas' products are provided only subject to Renesas' Terms and Conditions of Sale or other applicable terms agreed to in writing. No use of any Renesas resources expands or otherwise alters any applicable warranties or warranty disclaimers for these products.

(Disclaimer Rev.1.01 Jan 2024)

### Corporate Headquarters

TOYOSU FORESIA, 3-2-24 Toyosu,  
Koto-ku, Tokyo 135-0061, Japan  
[www.renesas.com](http://www.renesas.com)

### Trademarks

Renesas and the Renesas logo are trademarks of Renesas Electronics Corporation. All trademarks and registered trademarks are the property of their respective owners.

### Contact Information

For further information on a product, technology, the most up-to-date version of a document, or your nearest sales office, please visit [www.renesas.com/contact-us/](http://www.renesas.com/contact-us/).