

SECTION "X-X"
TRAY STACKING DETAIL
SCALE : 3/1

SECTION "Y-Y"
TRAY STACKING DETAIL
SCALE : 3/1

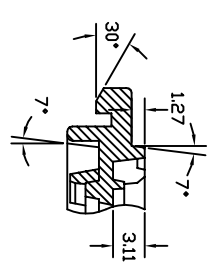

DETAIL "H"
SCALE : 4/1

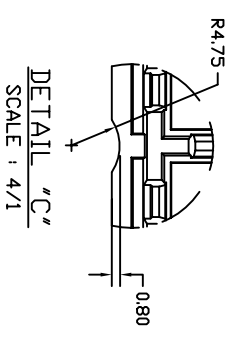

DETAIL "C"
SCALE : 4/1

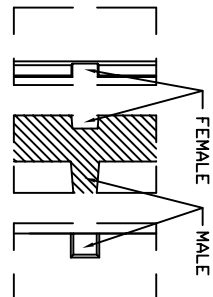

SLIP-LOCK DETAILS
DETAIL "D"
SCALE : 4/1

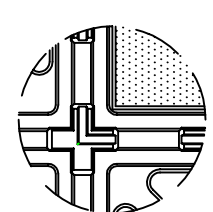

BOTTOM VIEW
DETAIL "G"
SCALE : 4/1

NOTES : (UNLESS OTHERWISE SPECIFIED)
1. NUMBER OF POCKET : 5 X 12 = 60 POCKETS

TOLERANCES UNLESS OTHERWISE SPECIFIED		ANGLE	
X ± .10		XX ± .10	
APPROVALS	DATE	WWW.IDT.COM	
DRAWN		6024 Silver Creek Valley Road, San Jose, CA 95138 PHONE: (408) 284-8200 FAX: (408) 284-3572	
TITLE:		BC/BCG/BL/BLG/BR 484, BX/BXG 288 & HL/HLG 484 SHIPPING TRAY	
STOCK NO.	N/A	DRAWING NO.	MSC-5719-A
DO NOT SCALE DRAWING		REV	00
		SCALE	N/A
		SIZE	00
		SHEET	1 OF 2

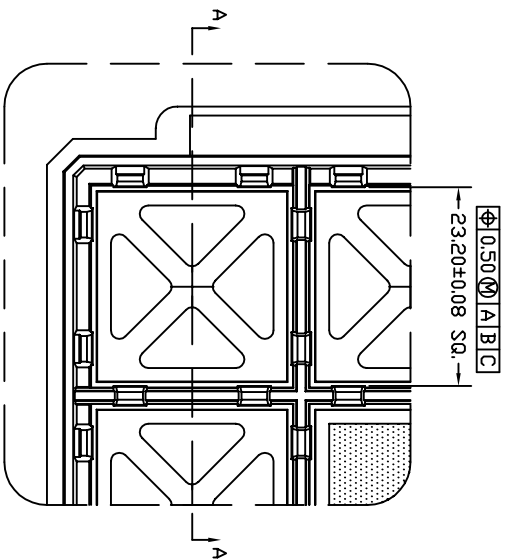

TOP VIEW
DETAIL "B"
SCALE : 3/1
(FROM SHT.#1)

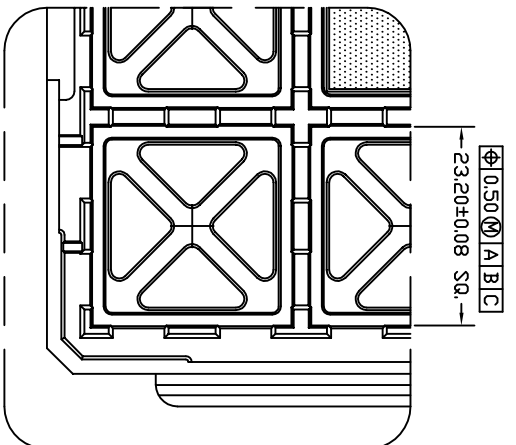

BOTTOM VIEW
DETAIL "B"
SCALE : 3/1
(FROM SHT.#1)

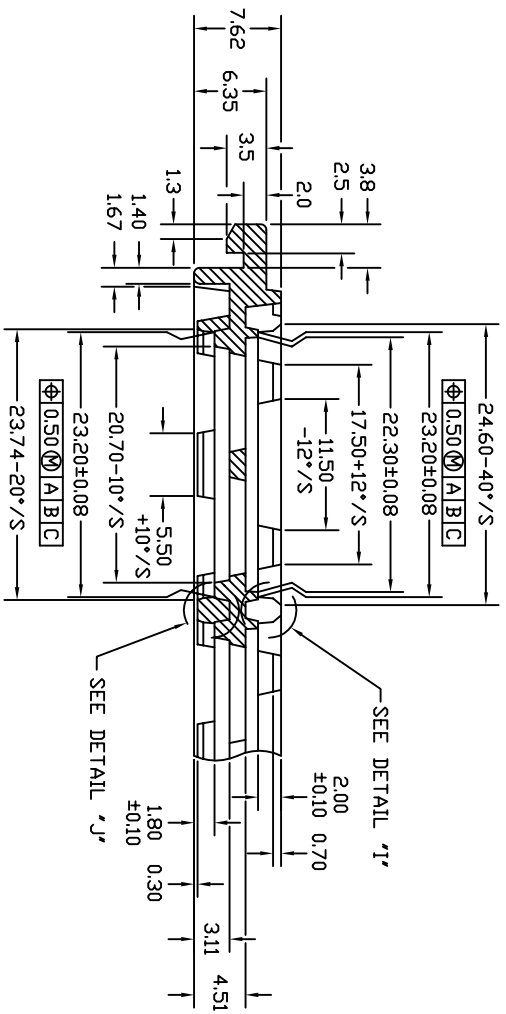

SECTION "A-A"
SCALE : 4/1

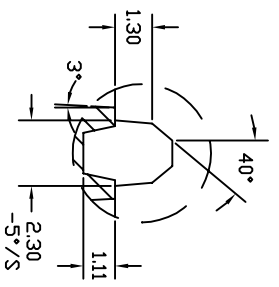

DETAIL "I"
SCALE : 10/1

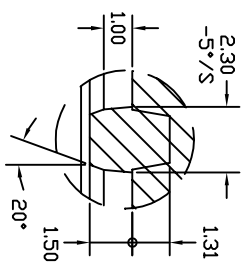

DETAIL "J"
SCALE : 10/1

TOLERANCES UNLESS OTHERWISE SPECIFIED
DECIMAL
X ± .10
XX ± .10

APPROVALS DATE

DRAWN

IDT
6024 Silver Creek Valley Road,
San Jose, CA 95138
PHONE: (408) 284-8200
FAX: (408) 284-3572
www.IDT.com

TITLE: BC/BCG/BL/BLG/BR 484, BX/BXG
288 & HL/HLG 484 SHIPPING TRAY

STOCK NO. N/A
DRAWING NO. MSC-5719-A
REV 00

DO NOT SCALE DRAWING SHEET 2 OF 2