

To our customers,

Old Company Name in Catalogs and Other Documents

On April 1st, 2010, NEC Electronics Corporation merged with Renesas Technology Corporation, and Renesas Electronics Corporation took over all the business of both companies. Therefore, although the old company name remains in this document, it is a valid Renesas Electronics document. We appreciate your understanding.

Renesas Electronics website: <http://www.renesas.com>

April 1st, 2010
Renesas Electronics Corporation

Issued by: Renesas Electronics Corporation (<http://www.renesas.com>)

Send any inquiries to <http://www.renesas.com/inquiry>.

Notice

1. All information included in this document is current as of the date this document is issued. Such information, however, is subject to change without any prior notice. Before purchasing or using any Renesas Electronics products listed herein, please confirm the latest product information with a Renesas Electronics sales office. Also, please pay regular and careful attention to additional and different information to be disclosed by Renesas Electronics such as that disclosed through our website.
2. Renesas Electronics does not assume any liability for infringement of patents, copyrights, or other intellectual property rights of third parties by or arising from the use of Renesas Electronics products or technical information described in this document. No license, express, implied or otherwise, is granted hereby under any patents, copyrights or other intellectual property rights of Renesas Electronics or others.
3. You should not alter, modify, copy, or otherwise misappropriate any Renesas Electronics product, whether in whole or in part.
4. Descriptions of circuits, software and other related information in this document are provided only to illustrate the operation of semiconductor products and application examples. You are fully responsible for the incorporation of these circuits, software, and information in the design of your equipment. Renesas Electronics assumes no responsibility for any losses incurred by you or third parties arising from the use of these circuits, software, or information.
5. When exporting the products or technology described in this document, you should comply with the applicable export control laws and regulations and follow the procedures required by such laws and regulations. You should not use Renesas Electronics products or the technology described in this document for any purpose relating to military applications or use by the military, including but not limited to the development of weapons of mass destruction. Renesas Electronics products and technology may not be used for or incorporated into any products or systems whose manufacture, use, or sale is prohibited under any applicable domestic or foreign laws or regulations.
6. Renesas Electronics has used reasonable care in preparing the information included in this document, but Renesas Electronics does not warrant that such information is error free. Renesas Electronics assumes no liability whatsoever for any damages incurred by you resulting from errors in or omissions from the information included herein.
7. Renesas Electronics products are classified according to the following three quality grades: “Standard”, “High Quality”, and “Specific”. The recommended applications for each Renesas Electronics product depends on the product’s quality grade, as indicated below. You must check the quality grade of each Renesas Electronics product before using it in a particular application. You may not use any Renesas Electronics product for any application categorized as “Specific” without the prior written consent of Renesas Electronics. Further, you may not use any Renesas Electronics product for any application for which it is not intended without the prior written consent of Renesas Electronics. Renesas Electronics shall not be in any way liable for any damages or losses incurred by you or third parties arising from the use of any Renesas Electronics product for an application categorized as “Specific” or for which the product is not intended where you have failed to obtain the prior written consent of Renesas Electronics. The quality grade of each Renesas Electronics product is “Standard” unless otherwise expressly specified in a Renesas Electronics data sheets or data books, etc.
 - “Standard”: Computers; office equipment; communications equipment; test and measurement equipment; audio and visual equipment; home electronic appliances; machine tools; personal electronic equipment; and industrial robots.
 - “High Quality”: Transportation equipment (automobiles, trains, ships, etc.); traffic control systems; anti-disaster systems; anti-crime systems; safety equipment; and medical equipment not specifically designed for life support.
 - “Specific”: Aircraft; aerospace equipment; submersible repeaters; nuclear reactor control systems; medical equipment or systems for life support (e.g. artificial life support devices or systems), surgical implantations, or healthcare intervention (e.g. excision, etc.), and any other applications or purposes that pose a direct threat to human life.
8. You should use the Renesas Electronics products described in this document within the range specified by Renesas Electronics, especially with respect to the maximum rating, operating supply voltage range, movement power voltage range, heat radiation characteristics, installation and other product characteristics. Renesas Electronics shall have no liability for malfunctions or damages arising out of the use of Renesas Electronics products beyond such specified ranges.
9. Although Renesas Electronics endeavors to improve the quality and reliability of its products, semiconductor products have specific characteristics such as the occurrence of failure at a certain rate and malfunctions under certain use conditions. Further, Renesas Electronics products are not subject to radiation resistance design. Please be sure to implement safety measures to guard them against the possibility of physical injury, and injury or damage caused by fire in the event of the failure of a Renesas Electronics product, such as safety design for hardware and software including but not limited to redundancy, fire control and malfunction prevention, appropriate treatment for aging degradation or any other appropriate measures. Because the evaluation of microcomputer software alone is very difficult, please evaluate the safety of the final products or system manufactured by you.
10. Please contact a Renesas Electronics sales office for details as to environmental matters such as the environmental compatibility of each Renesas Electronics product. Please use Renesas Electronics products in compliance with all applicable laws and regulations that regulate the inclusion or use of controlled substances, including without limitation, the EU RoHS Directive. Renesas Electronics assumes no liability for damages or losses occurring as a result of your noncompliance with applicable laws and regulations.
11. This document may not be reproduced or duplicated, in any form, in whole or in part, without prior written consent of Renesas Electronics.
12. Please contact a Renesas Electronics sales office if you have any questions regarding the information contained in this document or Renesas Electronics products, or if you have any other inquiries.

(Note 1) “Renesas Electronics” as used in this document means Renesas Electronics Corporation and also includes its majority-owned subsidiaries.

(Note 2) “Renesas Electronics product(s)” means any product developed or manufactured by or for Renesas Electronics.

R8C/25 Group

Timer RB in Programmable Wait One-shot Generation Mode

1. Abstract

This document describes how to set up and use the timer RB in programmable wait one-shot generation mode on the R8C/25 Group device.

2. Introduction

The application example described in this document is applied to the following:

- MCU: R8C/25 Group
- XIN clock: 20 MHz

This program can be used with other R8C/Tiny Series which have the same SFR (special function register) as the R8C/25 Group. Check the manual for any additions and modifications to functions. Careful evaluation is recommended before using this application note.

3. Applications

3.1 Timer RB

Timer RB is an 8-bit timer with an 8-bit prescaler.

The prescaler and timer each consist of a reload register and counter. The reload register and counter are allocated at the same address (refer to Table 3.1 Programmable Wait One-shot Generation Mode Specifications for access to the reload register and counter).

Timer RB has timer RB primary and timer RB secondary as reload registers.

The count source for timer RB is the operating clock that regulates the timing of timer operations such as counting and reloading.

Figure 3.1 shows a Block Diagram of Timer RB.

Timer RB has four operation modes listed as follows:

- Timer mode: The timer counts an internal count source (peripheral function clock or timer RA underflows).
- Programmable waveform generation mode: The timer outputs pulses of a given width successively.
- Programmable one-shot generation mode: The timer outputs a one-shot pulse.
- Programmable wait one-shot generation mode: The timer outputs a delayed one-shot pulse.

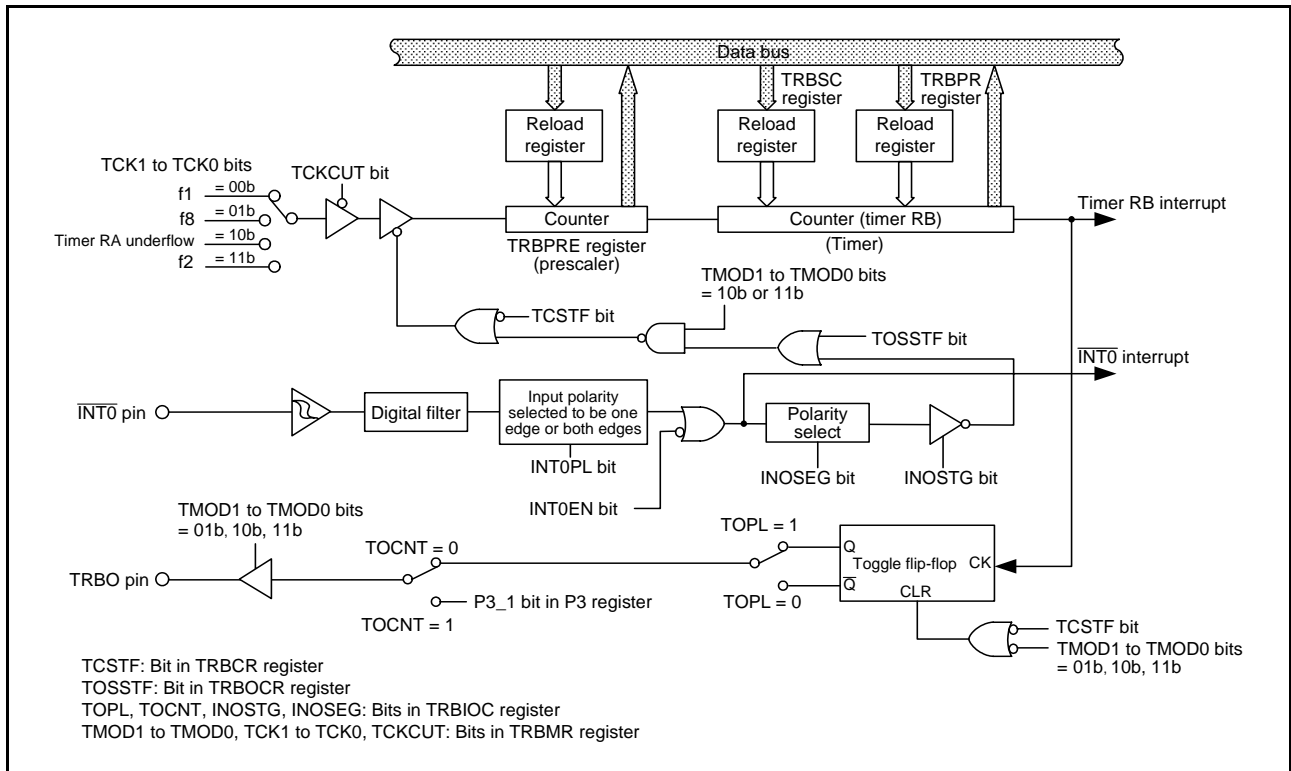

Figure 3.1 Block Diagram of Timer RB

3.2 Programmable Wait One-shot Generation Mode

In programmable wait one-shot mode, a one-shot pulse is output from the TRBO pin by a program or an external trigger input (input to the $\overline{\text{INT0}}$ pin) (refer to Table 3.1). When a trigger is generated from that point, the timer outputs a pulse only once for a given length of time equal to the setting value in the TRBSC register after waiting for a given length of time equal to the setting value in the TRBPR register.

Figure 3.2 shows Registers TRBCR and TRBOCR in Programmable Wait One-shot Generation Mode, and Figure 3.3 shows Registers TRBIOC and TRBMR in Programmable Wait One-shot Generation Mode, Figure 3.4 shows Registers TRBPRES, TRBCSC, and TRBPR in Programmable Wait One-shot Generation Mode. Figure 3.5 shows an Operating Example of Timer RB in Programmable Wait One-shot Generation Mode.

Table 3.1 Programmable Wait One-shot Generation Mode Specifications

Item	Specification
Count sources	f1, f2, f8, timer RA underflow
Count operations	<ul style="list-style-type: none"> • Decrement the timer RB primary setting value. • When a count of the timer RB primary underflows, the timer reloads the contents of timer RB secondary before the count continues. • When a count of the timer RB secondary underflows, the timer reloads the contents of timer RB primary before the count completes and the TOSSTF bit is set to 0 (one-shot stops). • When the count stops, the timer reloads the contents of the reload register before it stops.
Wait time	$(n+1)(m+1)/f_i$ <i>f_i</i> : Count source frequency <i>n</i> : Value set in the TRBPRES register, <i>m</i> : Value set in the TRBPR register
One-shot pulse output time	$(n+1)(p+1)/f_i$ <i>f_i</i> : Count source frequency <i>n</i> : Value set in the TRBPRES register, <i>p</i> : Value set in the TRBSC register
Count start conditions	<ul style="list-style-type: none"> • The TSTART bit in the TRBCR register is set to 1 (count starts) and the next trigger is generated. • Set the TOSST bit in the TRBOCR register to 1 (one-shot starts). • Input trigger to the INT0 pin
Count stop conditions	<ul style="list-style-type: none"> • When reloading completes after timer RB underflows during primary period. • When the TOSSP bit in the TRBOCR register is set to 0 (one-shot stops). • When the TSTART bit in the TRBCR register is set to 0 (count starts). • When the TSTOP bit in the TRBCR register is set to 1 (count forcibly stops).
Interrupt request generation timing	In half a cycle of the count source after timer RB underflows during secondary period (complete at the same time as waveform output from the TRBO pin) [timer RB interrupt].
TRBO pin function	Pulse output
INT0 pin function	<ul style="list-style-type: none"> • When the INOSTG bit in the TRBIOC register is set to 0 ($\overline{\text{INT0}}$ one-shot trigger disabled): programmable I/O port or INT0 interrupt input • When the INOSTG bit in the TRBIOC register is set to 1 ($\overline{\text{INT0}}$ one-shot trigger enabled): external trigger ($\overline{\text{INT0}}$ interrupt input)
Read from timer	The count value can be read out by reading registers TRBPR and TRBPRES.
Write to timer	<ul style="list-style-type: none"> • When registers TRBPRES, TRBSC, and TRBPR are written while the count stops, values are written to both the reload register and counter. • When registers TRBPRES, TRBSC, and TRBPR are written to during count operation, values are written to the reload registers only.⁽¹⁾
Select functions	<ul style="list-style-type: none"> • Output level select function The TOPL bit in the TRBIOC register selects the output level of the one-shot pulse waveform. • One-shot trigger select function Refer to 3.3 One-Shot Trigger Selection.

NOTES:

1. The set value is reflected at the following one-shot pulse after writing to registers TRBSC and TRBPR.

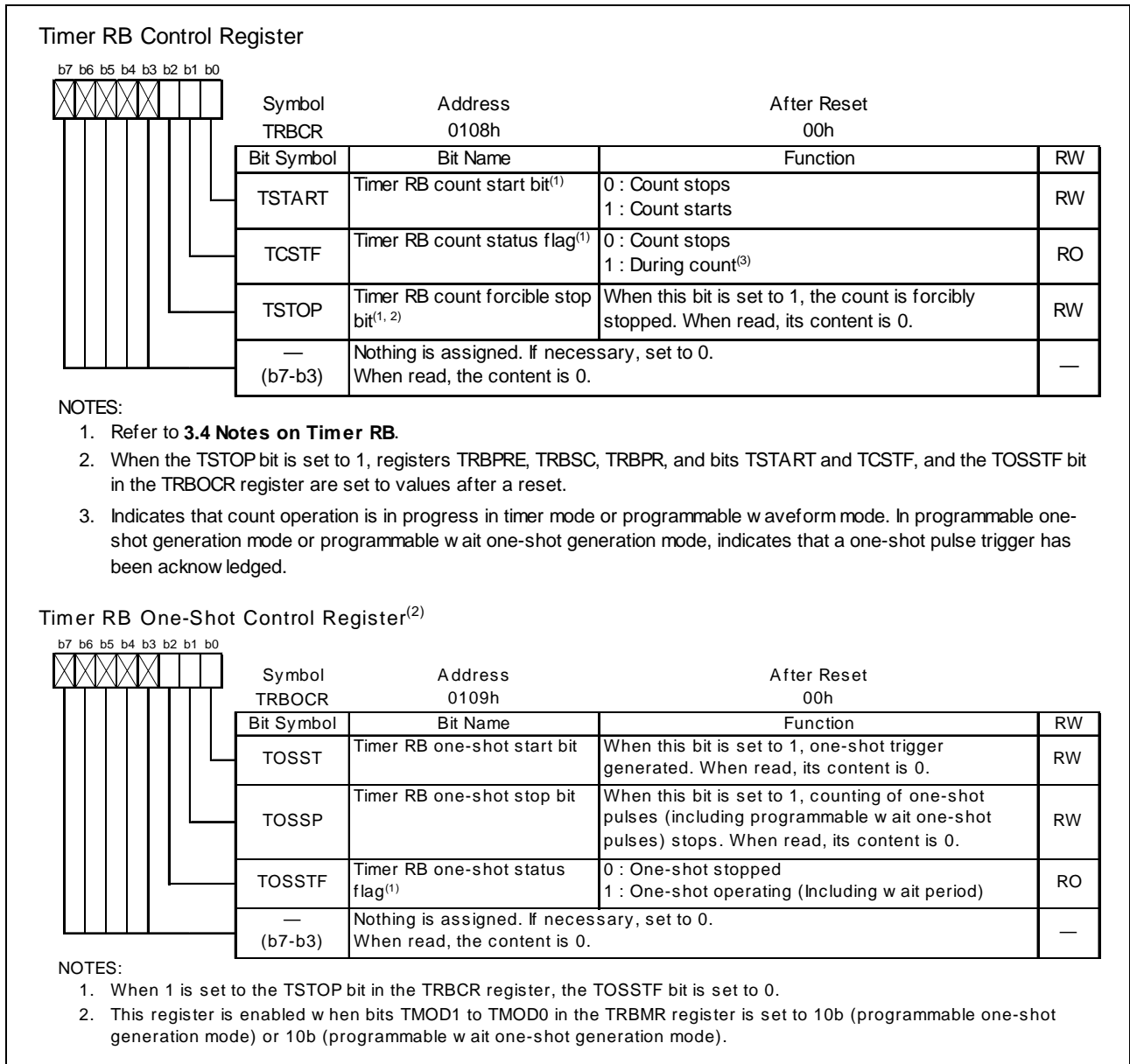

Figure 3.2 Registers TRBCR and TRBOCR in Programmable Wait One-shot Generation Mode

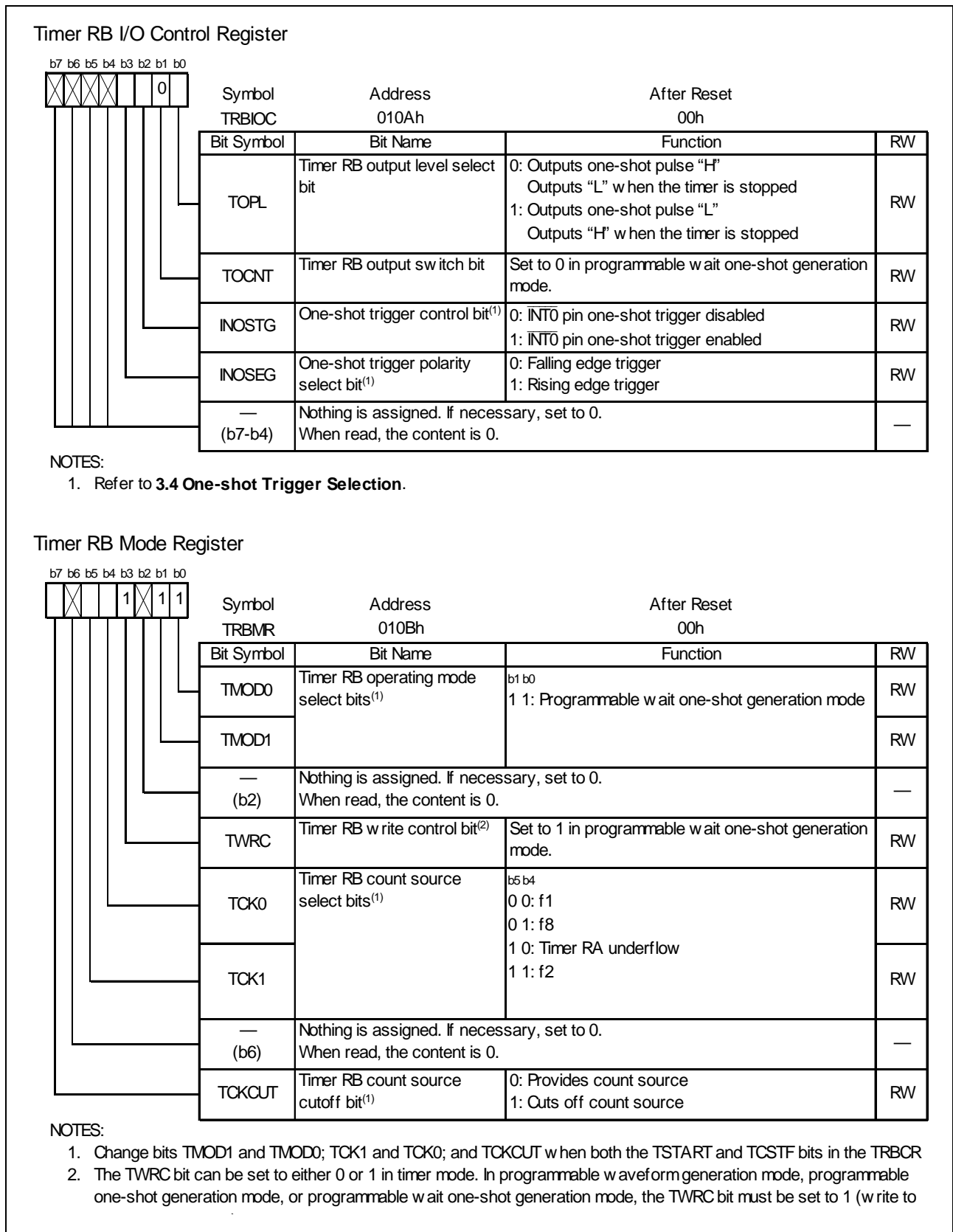

Figure 3.3 Registers TRBIOC and TRBMR in Programmable Wait One-shot Generation Mode

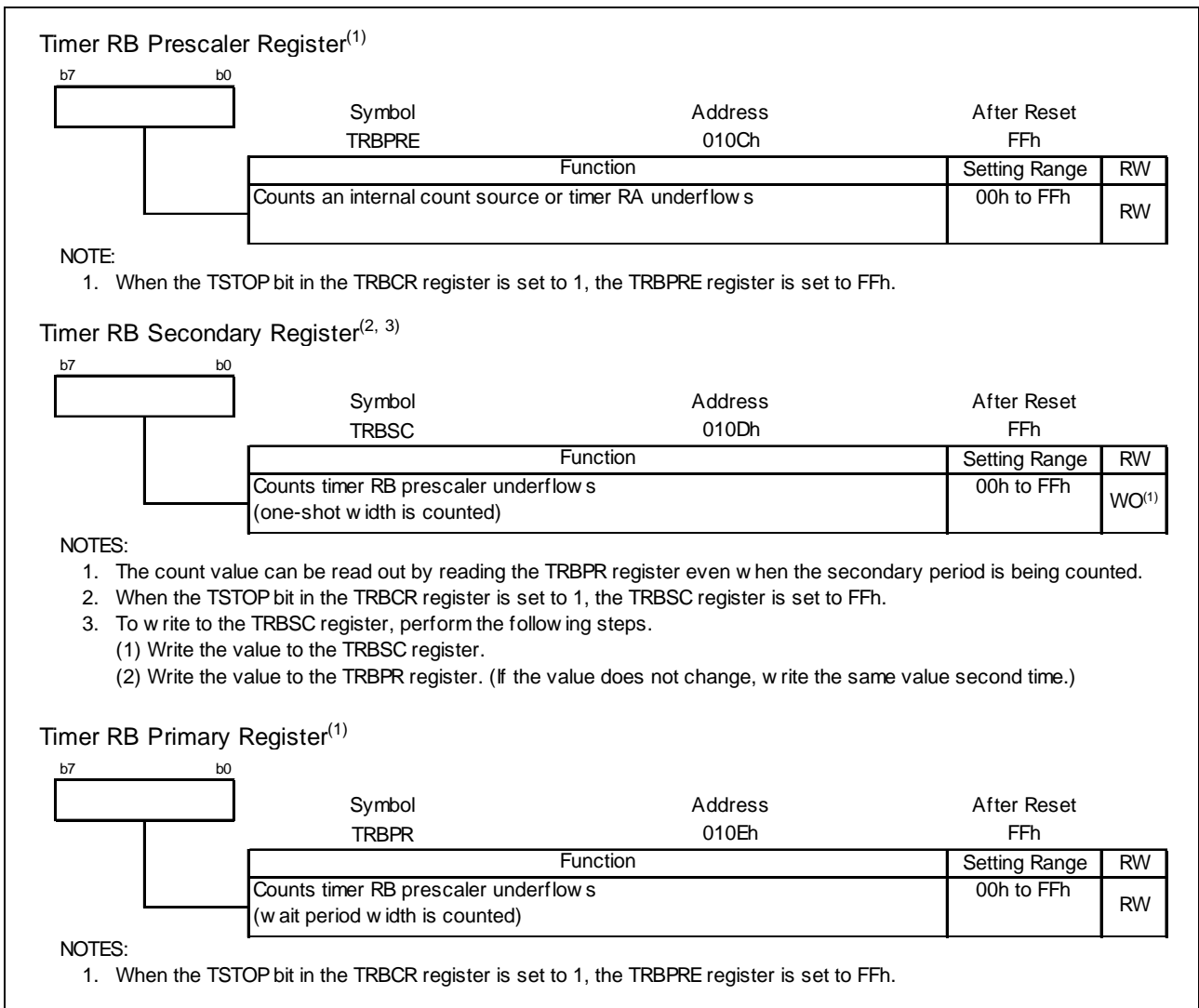

Figure 3.4 Registers TRBPRES, TRBSC, and TRBPR in Programmable Wait One-shot Generation Mode

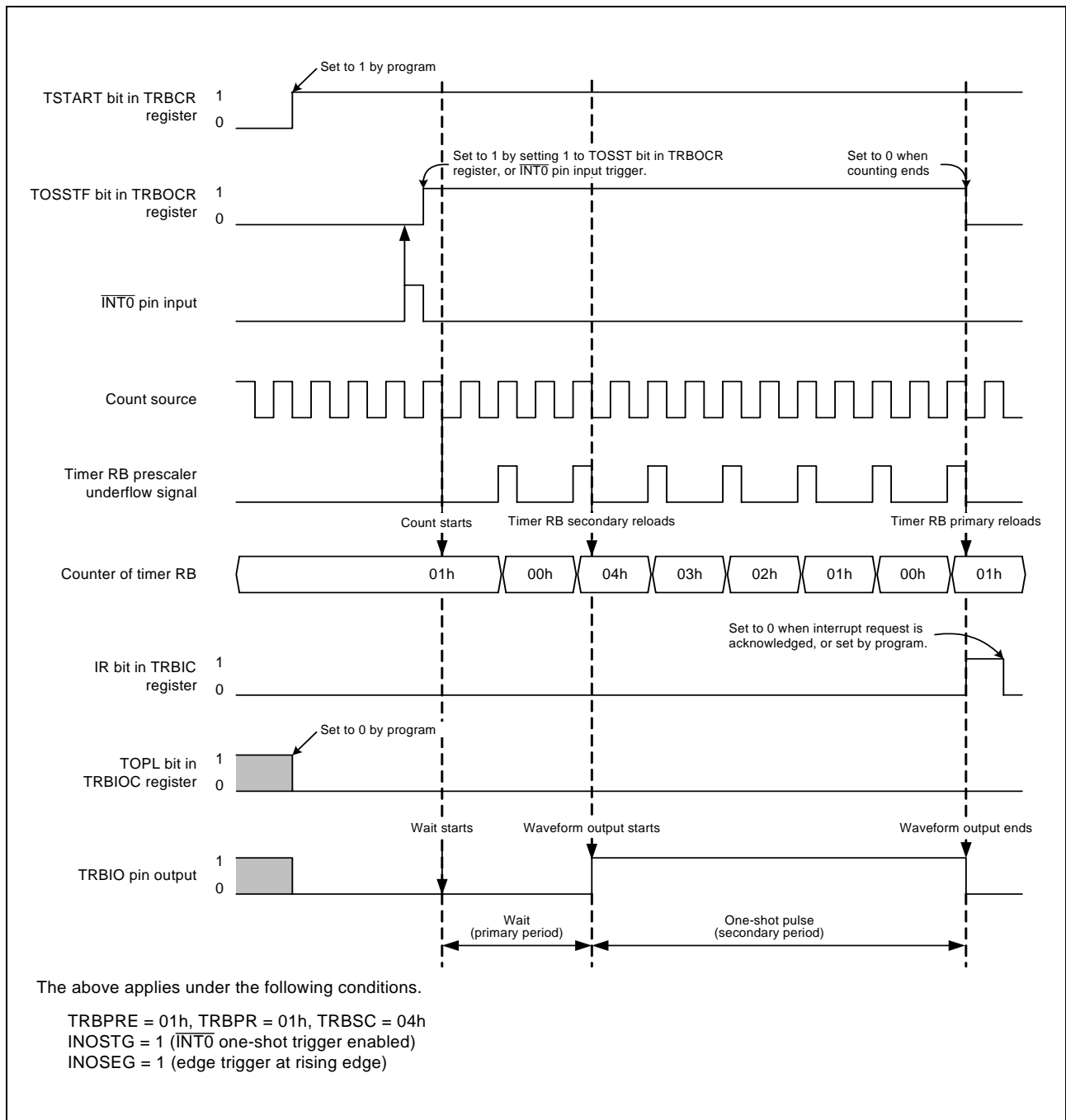

Figure 3.5 Operating Example of Timer RB in Programmable Wait One-shot Generation Mode

3.3 One-Shot Trigger Selection

In programmable one-shot generation mode and programmable wait one-shot generation mode, operation starts when a one-shot trigger is generated while the TCSTF bit in the TRBCR register is set to 1 (count starts).

A one-shot trigger can be generated by either of the following causes:

- 1 is written to the TOSSTF bit in the TRBOCR register by a program.
- Trigger input from the $\overline{\text{INT0}}$ pin.

When a one-shot trigger occurs, the TOSSTF bit in the TRBOCR register is set to 1 (one-shot operation in progress) after one or two cycles of the count source have elapsed. Then, in programmable one-shot generation mode, count operation begins and one-shot waveform output starts. (In programmable wait one-shot generation mode, count operation starts for the wait period.) If a one-shot trigger occurs while the TOSSTF bit is set to 1, no retriggering occurs.

To use trigger input from the $\overline{\text{INT0}}$ pin, input the trigger after making the following settings:

- Set the PD4_5 bit in the PD4 register to 0 (input port).
- Select the $\overline{\text{INT0}}$ digital filter with bits INT0F1 and INT0F0 in the INTF register.
- Select both edges or one edge with the INT0PL bit in INTEN register. If one edge is selected, further select falling or rising edge with the INOSEG bit in TRBIOC register.
- Set the INTOEN bit in the INTEN register to 0 (enabled).
- After completing the above, set the INOSTG bit in the TRBIOC register to 1 ($\overline{\text{INT}}$ pin one-shot trigger enabled).

Note the following points with regard to generating interrupt requests by trigger input from the $\overline{\text{INT0}}$ pin.

- Processing to handle the interrupts is required. Refer to **12. Interrupts in “R8C/24, R8C/25 Group Hardware Manual” (Document No. REJ09B0244)**, for details.
- If one edge is selected, use the POL bit in the INTOIC register to select falling or rising edge. (The INOSEG bit in the TRBIOC register does not affect $\overline{\text{INT0}}$ interrupts).
- If a one-shot trigger occurs while the TOSSTF bit is set to 1, timer RB operation is not affected, but the value of the IR bit in the INTOIC register changes.

3.4 Notes on Timer RB

- Timer RB stops counting after a reset. Set the values in the timer RB and timer RB prescalers before the count starts.
- Even if the prescaler and timer RB is read out in 16-bit units, these registers are read 1 byte at a time by the MCU. Consequently, the timer value may be updated during the period when these two registers are being read.
- In programmable one-shot generation mode and programmable wait one-shot generation mode, when setting the TSTART bit in the TRBCR register to 0 (count stops) or setting the TOSSP bit in the TRBOCR register to 1 (one-shot stops), the timer reloads the value of reload register and stops. Therefore, in programmable one-shot generation mode and programmable wait one-shot generation mode, read the timer count value before the timer stops.
- The TCSTF bit remains 0 (count stops) for 1 to 2 cycles of the count source after setting the TSTART bit to 1 (count starts) while the count is stopped.

During this time, do not access registers associated with timer RB⁽¹⁾ other than the TCSTF bit.

The TCSTF bit remains 1 for 1 to 2 cycles of the count source after setting the TSTART bit to 0 (count stops) while the count is in progress.

During this time, do not access registers associated with timer RB⁽¹⁾ other than the TCSTF bit.

Timer RB counting is stopped when the TCSTF bit is set to 0.

NOTE:

1. Registers associated with timer RB: TRBCR, TRBOCR, TRBMR, TRBPRES, TRBSC, and TRRBPR.
- If the TSTOP bit in the TRBCR register is set to 1 during timer operation, timer RB stops immediately.
 - If 1 is written to the TOSST or TOSSP bit in the TRBOCR register, the value of the TOSSTF bit changes after one or two cycles of the count source have elapsed. If the TOSSP bit is written to 1 during the period between when the TOSST bit is written to 1 and when the TOSSTF bit is set to 1, the TOSSTF bit may be set to either 0 or 1 depending on the content state. Likewise, if the TOSST bit is written to 1 during the period between when the TOSSP bit is written to 1 and when the TOSSTF bit is set to 0, the TOSSTF bit may be set to either 0 or 1.

4. Program Overview

By starting one-shot operation, a signal will be output from the TRBO pin as follows.

- Wait time: 1 ms
 $1\text{ ms} = 20\text{ MHz} \times f2 \times (\text{TRBPRE} + 1) \times (\text{TRBPR} + 1)$
 $= 50\text{ ns} \times 2 \times (199 + 1) \times (49 + 1)$
- One-shot pulse output time: 2 ms
 $2\text{ ms} = 20\text{ MHz} \times f2 (\text{TRBPRE} + 1) \times (\text{TRBSC} + 1)$
 $= 50\text{ ns} \times 2 \times (199 + 1) \times (99 + 1)$
- “H” output during one-shot pulse and “L” output when timer stops
- $\overline{\text{INTO}}$ pin one-shot trigger disabled

Figure 4.1 shows the Pin Used.

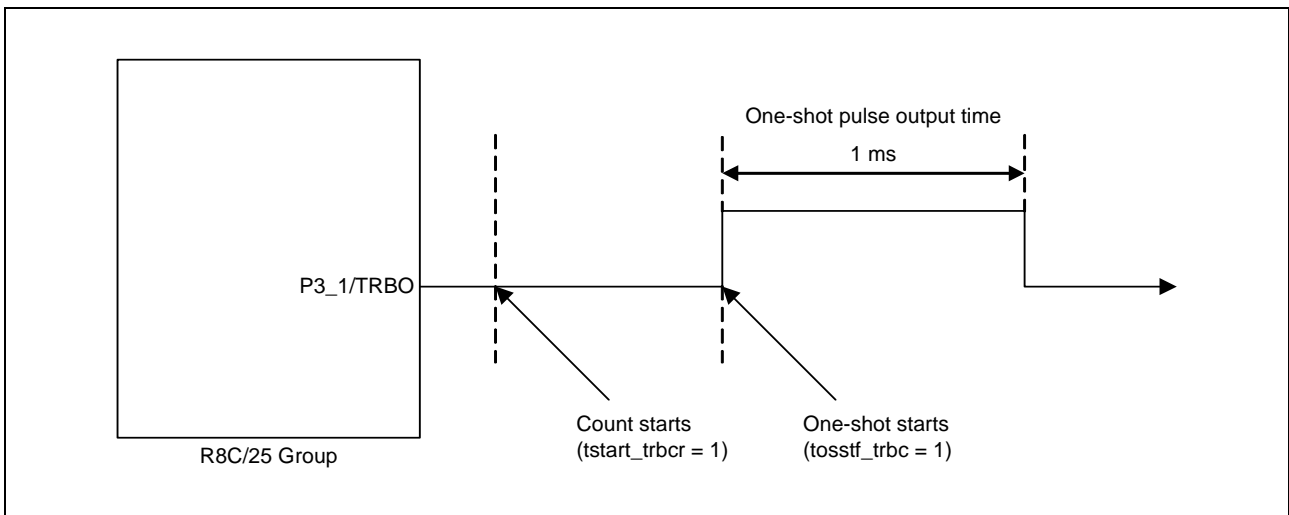

Figure 4.1 Pin Used

4.1 Faction Table

Table 4.1

Declaration	void timer_rb_init(void)		
Overview	SFR initial setting associated with timer RB		
Argument	Argument name	Meaning	
	None		
Variable used (global)	Variable name	Usage	
	None		
Return value	Type	Value	Meaning
	None		
Function	Initialize the SFR registers associated with time RB		

4.2 Flow Chart

4.2.1 Main functions

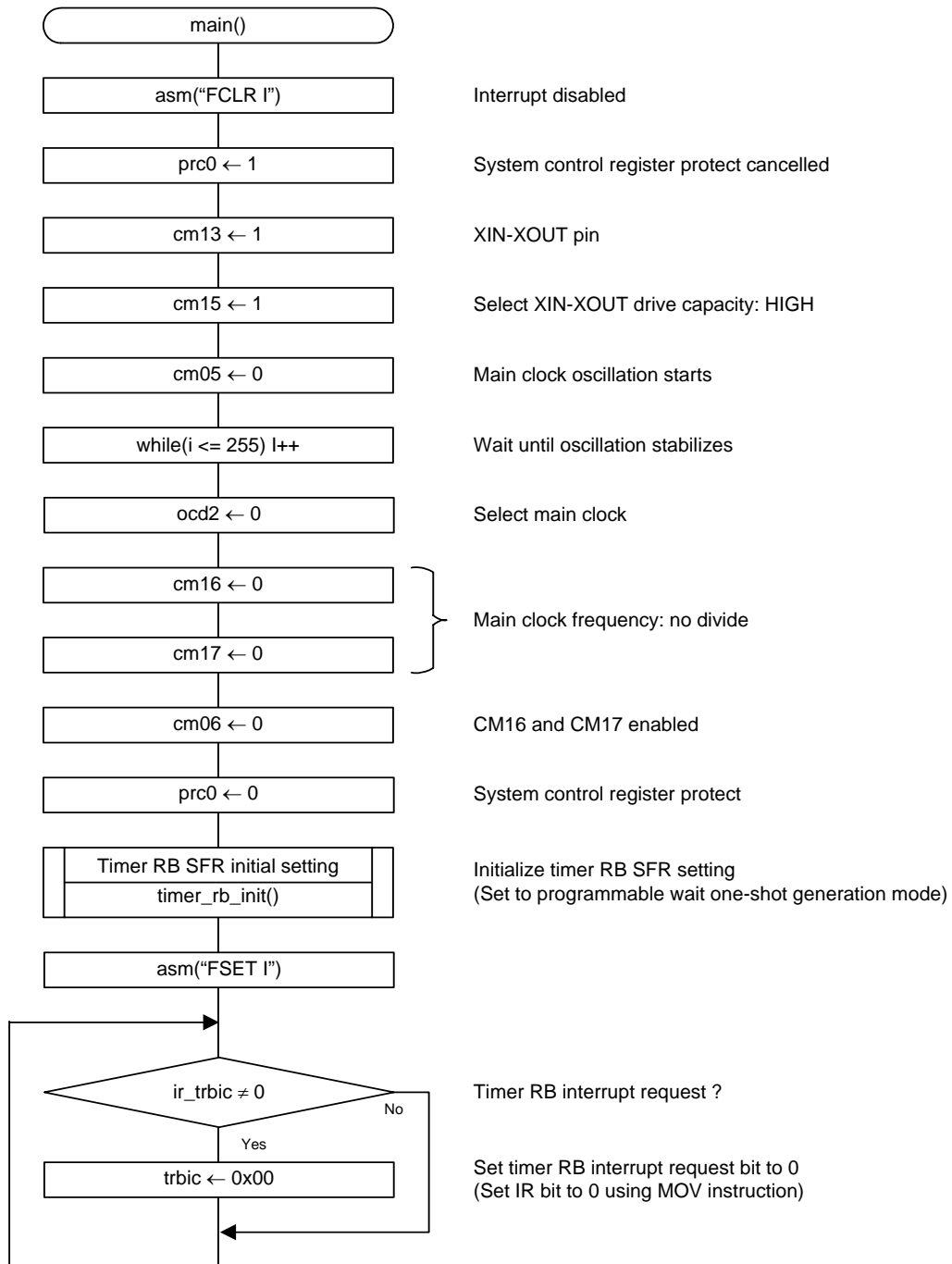

4.2.2 Timer RB SFR Initial Setting

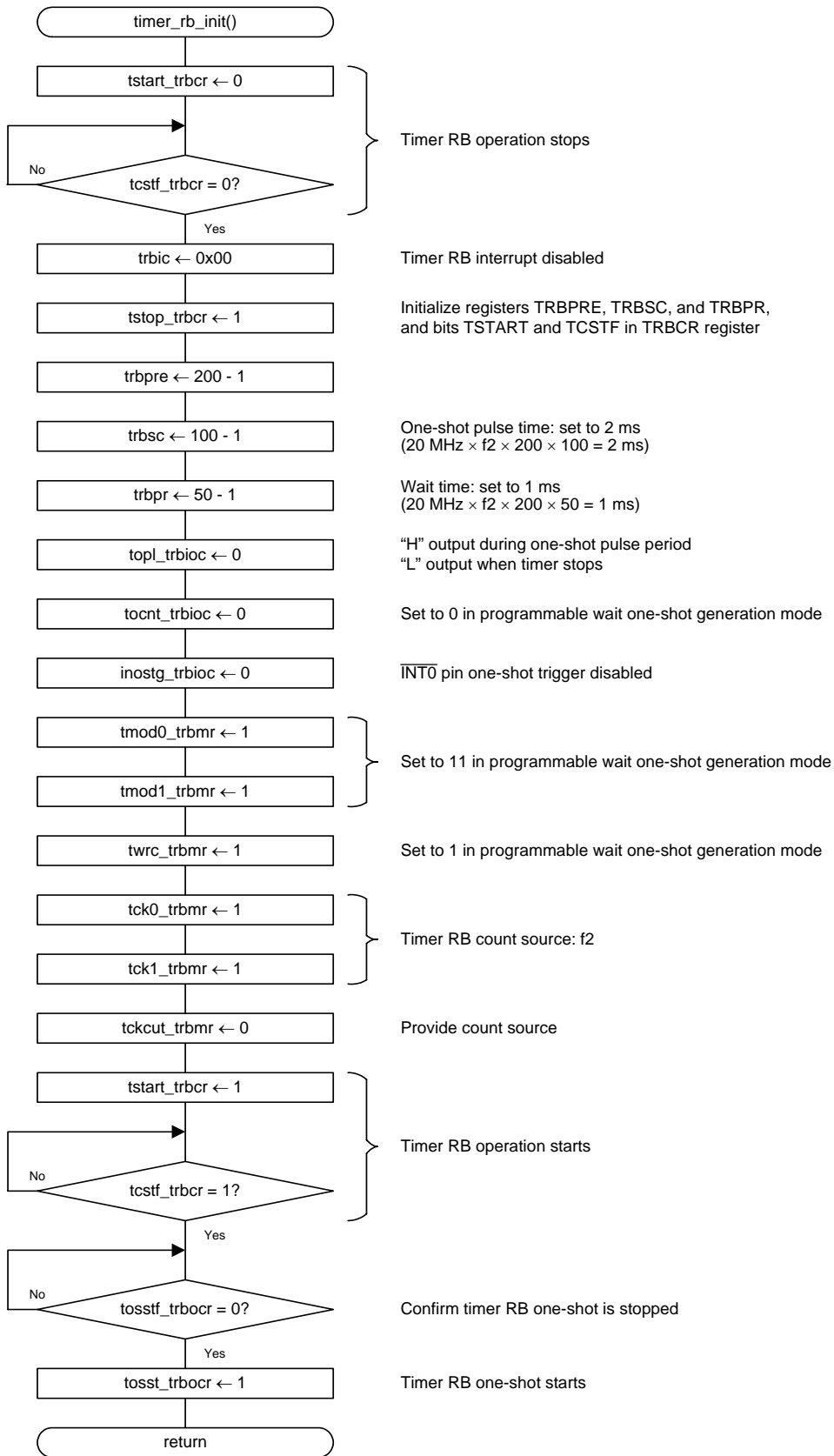

5. Sample Programming Code

Download a sample program on the Renesas Technology website.

To download, click Application Notes in the left-hand side menu on the top page of the R8C/Tiny Series.

6. Reference Document

Hardware Manual

R8C/25 Group Hardware Manual

(Download the latest version from the Renesas Technology website.)

Technical News/Technical Update

(Download the latest information from the Renesas Technology website.)

Website and Support

Renesas Technology website
<http://www.renesas.com/>

Inquiries
<http://www.renesas.com/inquiry>
csc@renesas.com

REVISION HISTORY	R8C/25 Group Timer RB in Programmable Wait One-shot Generation Mode
------------------	---

Rev.	Date	Description	
		Page	Summary
1.00	Sep 15, 2006	–	First Edition issued

Keep safety first in your circuit designs!

1. Renesas Technology Corp. puts the maximum effort into making semiconductor products better and more reliable, but there is always the possibility that trouble may occur with them. Trouble with semiconductors may lead to personal injury, fire or property damage. Remember to give due consideration to safety when making your circuit designs, with appropriate measures such as (i) placement of substitutive, auxiliary circuits, (ii) use of non-flammable material or (iii) prevention against any malfunction or mishap.

Notes regarding these materials

1. These materials are intended as a reference to assist our customers in the selection of the Renesas Technology Corp. product best suited to the customer's application; they do not convey any license under any intellectual property rights, or any other rights, belonging to Renesas Technology Corp. or a third party.
2. Renesas Technology Corp. assumes no responsibility for any damage, or infringement of any third-party's rights, originating in the use of any product data, diagrams, charts, programs, algorithms, or circuit application examples contained in these materials.
3. All information contained in these materials, including product data, diagrams, charts, programs and algorithms represents information on products at the time of publication of these materials, and are subject to change by Renesas Technology Corp. without notice due to product improvements or other reasons. It is therefore recommended that customers contact Renesas Technology Corp. or an authorized Renesas Technology Corp. product distributor for the latest product information before purchasing a product listed herein. The information described here may contain technical inaccuracies or typographical errors. Renesas Technology Corp. assumes no responsibility for any damage, liability, or other loss rising from these inaccuracies or errors. Please also pay attention to information published by Renesas Technology Corp. by various means, including the Renesas Technology Corp. Semiconductor home page (<http://www.renesas.com>).
4. When using any or all of the information contained in these materials, including product data, diagrams, charts, programs, and algorithms, please be sure to evaluate all information as a total system before making a final decision on the applicability of the information and products. Renesas Technology Corp. assumes no responsibility for any damage, liability or other loss resulting from the information contained herein.
5. Renesas Technology Corp. semiconductors are not designed or manufactured for use in a device or system that is used under circumstances in which human life is potentially at stake. Please contact Renesas Technology Corp. or an authorized Renesas Technology Corp. product distributor when considering the use of a product contained herein for any specific purposes, such as apparatus or systems for transportation, vehicular, medical, aerospace, nuclear, or undersea repeater use.
6. The prior written approval of Renesas Technology Corp. is necessary to reprint or reproduce in whole or in part these materials.
7. If these products or technologies are subject to the Japanese export control restrictions, they must be exported under a license from the Japanese government and cannot be imported into a country other than the approved destination. Any diversion or reexport contrary to the export control laws and regulations of Japan and/or the country of destination is prohibited.
8. Please contact Renesas Technology Corp. for further details on these materials or the products contained therein.