

## SH7216/SH7239/SH7231 Groups

### Data Transfer Within On-Chip RAM (Cycle Stealing Mode) Using the DMAC

---

R01AN1262EJ0100

Rev.1.00

Dec. 07, 2012

#### Abstract

This application note describes a sample program for the SH7216, SH7239, and SH7231 Group MCUs that transfers data using the direct memory access controller (DMAC).

The operation of this program has the following features.

- Use of DMAC channel 0
- Use of auto-request mode for DMA transfers
- Use of cycle stealing mode as the bus mode
- The transfer source and destination are both in RAM.

#### Products

SH7216, SH7239, and SH7231 Groups

When using this application note with other Renesas MCUs, careful evaluation is recommended after making modifications to comply with the alternate MCU.

## Contents

1. Specifications .....	3
2. Operation Confirmation Conditions .....	4
3. Reference Application Notes .....	5
4. Peripheral Functions.....	6
5. Software .....	8
5.1 Operation Overview .....	8
5.2 File Composition .....	9
5.3 Constants .....	9
5.4 Functions.....	9
5.5 Function Specifications .....	10
5.6 Flowcharts.....	12
5.6.1 Main Processing .....	12
5.6.2 Transfer Source/Transfer Destination Memory Area Initialization.....	13
5.6.3 DMAC Initialization .....	14
5.6.4 DMA Transfer Start Processing.....	15
5.6.5 DMA Transfer End Processing .....	15
6. Reference Documents.....	16

## 1. Specifications

This application note uses the direct memory access controller (DMAC) to transfer data within internal RAM.

The sample program sets the DMAC to cycle stealing mode and uses auto-request as the DMA transfer start factor. The sample program performs 128 transfers of 32 bits of data (for a total of 512 bytes).

Table 1.1 lists the peripheral functions used and their uses and figure 1.1 shows the block diagram of the peripheral functions used.

**Table 1.1 Peripheral Functions and Their Applications**

Peripheral Function	Application
Direct memory access controller (DMAC)	DMA data transfers
Internal RAM	Transfer source and destination

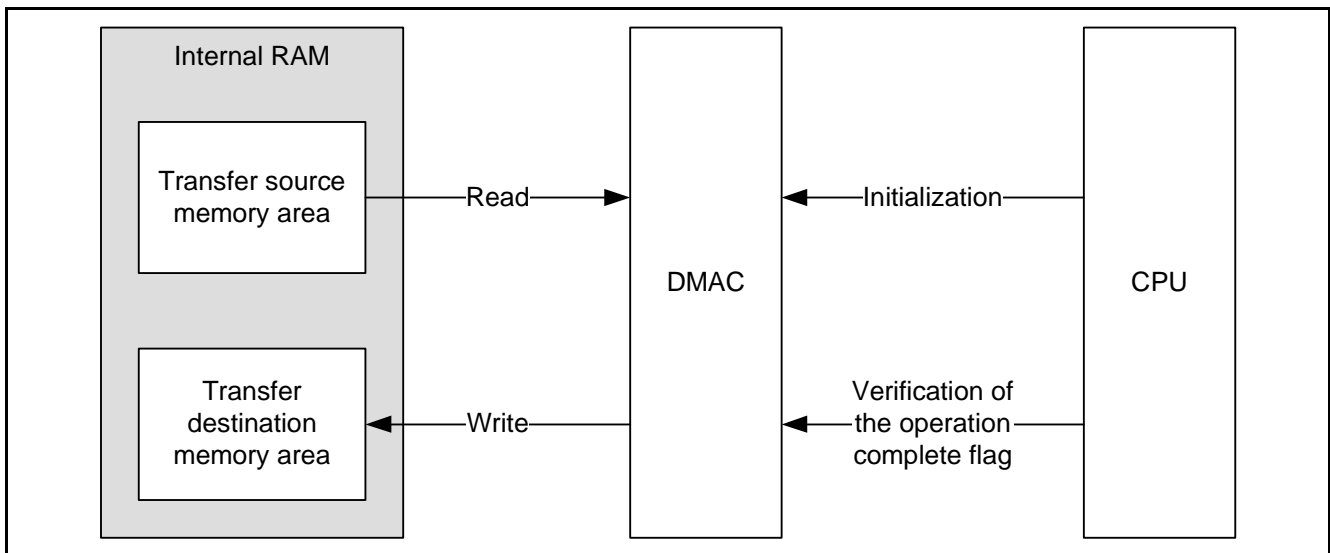

**Figure 1.1 Used Peripheral Function Block Diagram**

## 2. Operation Confirmation Conditions

The sample code described in this application note has been confirmed to run normally following conditions.

**Table 2.1 Operating Conditions (SH7216)**

Item	Contents
MCU used	SH7216
Operating frequency	Main clock: 200 MHz Bus clock: 50 MHz Peripheral clock: 50 MHz
Operating voltage	Vcc: 3.3 V
Integrated development environment	Renesas Electronics High-performance Embedded Workshop Ver.4.07.00
C compiler	Renesas Electronics Renesas SuperH RISC engine Family C/C++ Compiler Package Ver.9.03 Release 00 Compiler options: -cpu=sh2afpu -fpu=single -include="\$(WORKSPDIR)\inc" -object="\$(CONFIGDIR)\\$(FILELEAF).obj" -debug -gbr=auto -chgincpath -errorpath -global_volatile=0 -opt_range=all -infinite_loop=0 -del_vacant_loop=0 -struct_alloc=1 -nologo
Operating mode	User program mode
Version of the sample code	1.00
Board used	R0K572167C001BR

**Table 2.2 Operating Conditions (SH7239)**

Item	Contents
MCU used	SH7239A
Operating frequency	Main clock: 160 MHz Bus clock: 40 MHz Peripheral clock: 40 MHz
Operating voltage	Vcc: 3.3 V
Integrated development environment	Renesas Electronics High-performance Embedded Workshop Ver.4.07.00
C compiler	Renesas Electronics Renesas SuperH RISC engine Family C/C++ Compiler Package Ver.9.03 Release 02 Compiler options: -cpu=sh2afpu -fpu=single -include="\$(WORKSPDIR)\inc" -object="\$(CONFIGDIR)\\$(FILELEAF).obj" -debug -gbr=auto -chgincpath -errorpath -global_volatile=0 -opt_range=all -infinite_loop=0 -del_vacant_loop=0 -struct_alloc=1 -nologo
Operating mode	Single-chip mode
Version of the sample code	1.00
Board used	R0K572390C000BR

Table 2.3 Operating Conditions (SH7231)

Item	Contents
MCU used	SH7231
Operating frequency	Main clock: 100 MHz Bus clock: 50 MHz Peripheral clock: 50 MHz
Operating voltage	Vcc: 3.3 V
Integrated development environment	Renesas Electronics High-performance Embedded Workshop Ver.4.08.00
C compiler	Renesas Electronics Renesas SuperH RISC engine Family C/C++ Compiler Package Ver.9.04 Release 00 Compiler options: -cpu=sh2afpu -fpu=single -include="\$ (WORKSPDIR)\inc" -object="\$ (CONFIGDIR)\\$(FILELEAF).obj" -debug -gbr=auto -chgincpath -errorpath -global_volatile=0 -opt_range=all -infinite_loop=0 -del_vacant_loop=0 -struct_alloc=1 -nologo
Operating mode	Single-chip mode
Version of the sample code	1.00
Board used	R0K572310C000BR

### 3. Reference Application Notes

The following application notes are related to this document and should be referred to when using this application note.

- SH7216 Group Example of Initialization (RJJ06B1073)
- SH7239 Group Example of Initialization (R01AN0297EJ)
- SH7231 Group Example of Initialization (R01AN0322EJ)

## 4. Peripheral Functions

This section describes the direct memory access controller (DMAC). The basic description of this peripheral module is included in the SH7216 Group User's Manual: Hardware, SH7239 Group User's Manual: Hardware, and SH7231 Group User's Manual: Hardware documents.

When there are DMA transfer requests, the DMAC starts the transfer according to a predetermined channel priority and when the transfer complete conditions are met, it terminates the transfer. There are three transfer request modes: auto-request, external request, and internal peripheral module request. The bus mode can be selected to be either burst mode or cycle stealing mode.

Table 4.1 provides an overview of the DMAC. Figure 4.1 shows an example of a cycle stealing normal mode DMA transfer, and figure 4.2 shows an example of a burst mode DMA transfer.

**Table 4.1 DMAC Overview**

Item	Description
Number of channels	<ul style="list-style-type: none"> <li>SH7216 and SH7239: 8 channels, CH0 to CH7 (Only the four channels CH0 to CH3 can accept external requests.)</li> <li>SH7231: 4 channels, CH0 to CH3 (Only the two channels CH0 and CH1 can accept external requests.)</li> </ul>
Address space	4 GB (Logical address space)
Transfer data lengths	Byte, word (2 bytes), long word (4 bytes), and 16 bytes (long word × 4)
Maximum transfer count	16,777,216 (24 bits) transfers
Address modes	Single address mode and dual address mode
Transfer requests	External requests, internal peripheral module requests*, auto-requests
Bus modes	Cycle stealing mode (normal mode and intermittent mode), burst mode
Priority	Channel priority fixed mode, round robin mode
Interrupt requests	CPU interrupt requests can be generated at data transfer 1/2 complete and at data transfer complete.
External request detection	Low or high level detection and rising or falling edge detection for the DREQ input
Transfer request accept signal and transfer complete signal	The active levels for the DACK and TEND signals can be set.

Note: \* The factors supported depend on the MCU.

In cycle stealing normal mode, the DMAC releases bus rights to another bus master each time the transfer of a single transfer unit (byte, word, longword, or 16-byte unit) completes. If there is a transfer request after that, the DMAC reacquires bus rights from the other master, once again performs a single transfer unit transfer, and when that transfer completes releases bus rights to another bus master. This operation is repeated until the transfer complete conditions are met. Cycle stealing normal mode can be used in all transfer periods, regardless of the transfer request source, transfer source, or transfer destination.

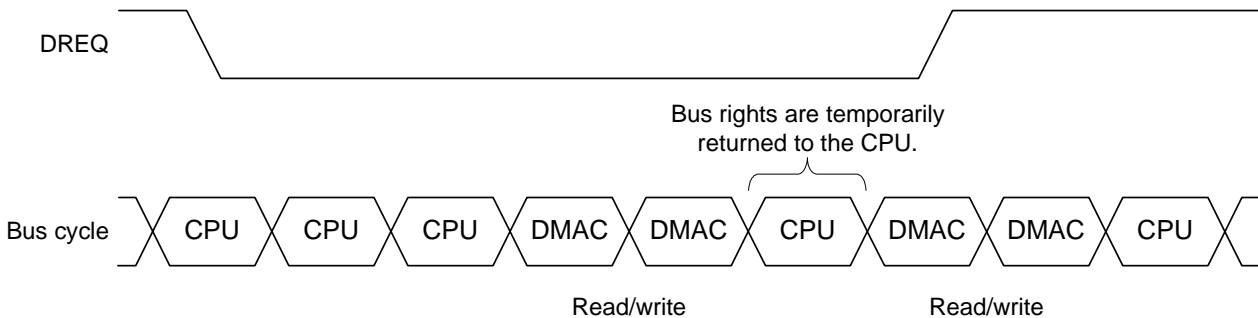

**Figure 4.1 Cycle Stealing Normal Mode DMA Transfer Example (dual address, DREQ low-level detection)**

In burst mode, once the DMAC has acquired bus rights, it continues the transfer operations without releasing those rights until the transfer complete conditions are met. However, in external request mode when level detection is used for DREQ, if the DREQ signal transitions away from the active level, after the DMAC transfer request that was already accepted completes, bus rights will be passed to another bus master, even if the transfer complete conditions are not met.

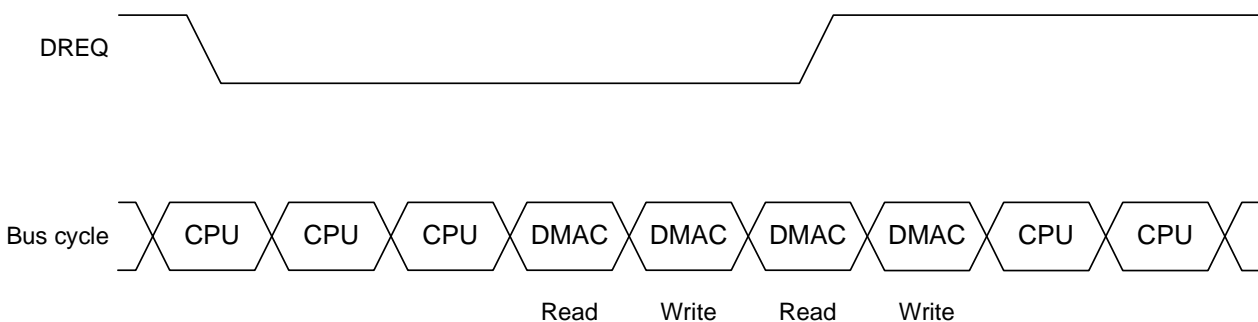

**Figure 4.2 Bus Mode DMA Transfer Example (dual address, DREQ low-level detection)**

## 5. Software

### 5.1 Operation Overview

The sample program writes a pattern to the transfer source memory area in advance and after setting up the DMAC, it starts an auto-request transfer to the transfer destination memory area by enabling DMAC operation in software.

Table 5.1 lists the DMAC settings. Figure 5.1 presents an overview of this operation.

**Table 5.1 DMAC Settings**

Item	Description
Channel used	CH0
Transfer data length	Long word (4 bytes)
Transfer count	128 transfers (128 transfers × 4 byte data length = 512 bytes of data)
Address mode	Dual address mode
Transfer request	Auto-request
Bus mode	Cycle stealing mode (normal mode)
Priority	Channel priority fixed mode
Interrupt	Interrupts disabled.

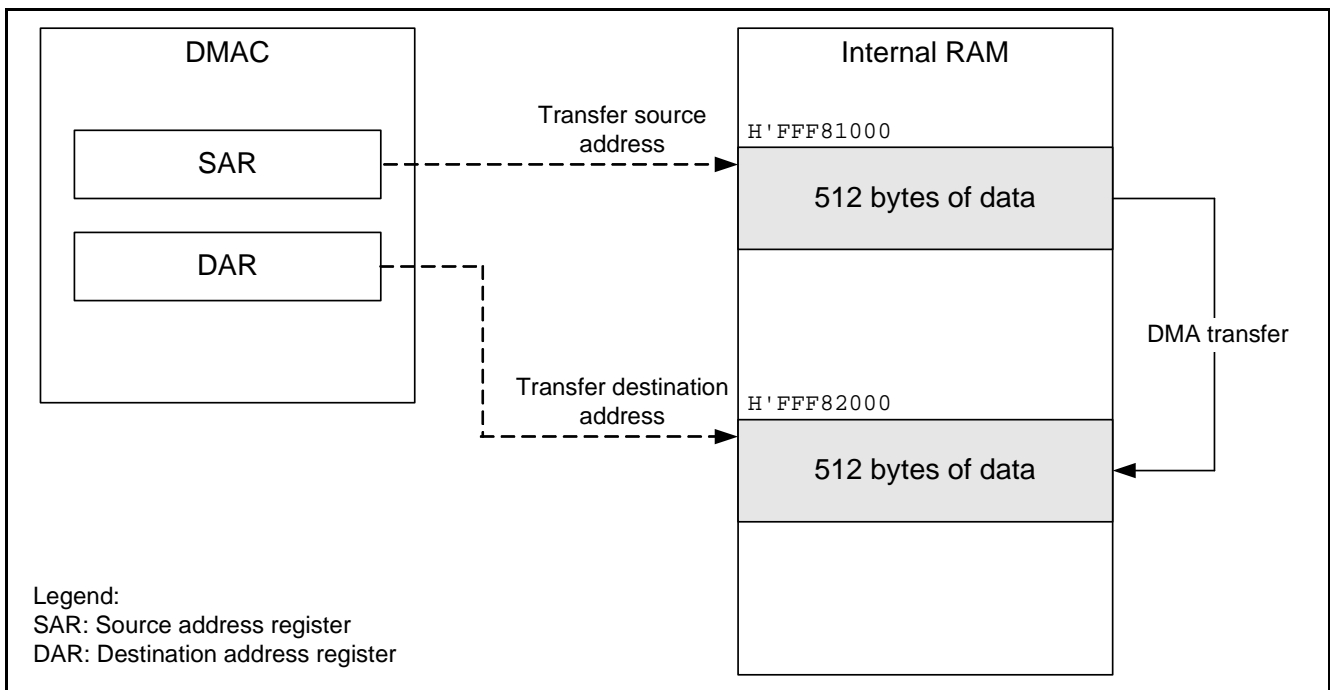

**Figure 5.1 Operation Overview**



## 5.2 File Composition

Table 5.2 lists the file used in the sample code. Files not generated by the integrated development environment should not be listed in this table.

**Table 5.2 File Used in the Sample Code**

File Name	Outline	Remarks
main.c	Main module	Initialization and DMA transfer processing

## 5.3 Constants

Table 5.3 lists the constants used in the sample code.

**Table 5.3 Constants Used in the Sample Code**

Constant Name	Setting Value	Contents
IRAM_SRC_ADDR	H'FFF8 1000	Transfer source start address (internal RAM)
IRAM_DST_ADDR	H'FFF8 2000	Transfer destination start address (internal RAM)
DMA_COUNT	128	DMA transfer count
DMA_SIZE	4	DMA transfer size

## 5.4 Functions

Table 5.4 lists the functions.

**Table 5.4 Functions**

Function Name	Outline
main	Main processing
memory_init	Transfer source/transfer destination memory area initialization
io_dma_init	DMAC initialization
io_dma_start	DMA transfer start processing
io_dma_poll_end	DMA transfer end processing

## 5.5 Function Specifications

The following tables list the sample code function specifications.

main	
<b>Outline Header</b>	Main processing
<b>Declaration</b>	void main(void)
<b>Description</b>	This function first initializes the transfer source and transfer destination memory areas. Then it initializes the DMAC, starts a DMA transfer, and waits for that transfer to complete. Finally, it enters an infinite loop.
<b>Arguments</b>	None
<b>Return Value</b>	None
memory_init	
<b>Outline Header</b>	Transfer source/transfer destination memory area initialization
<b>Declaration</b>	void memory_init(uint32_t src_addr, uint32_t dst_addr, uint32_t size)
<b>Description</b>	This function writes pattern data to the transfer source memory area. It clears the transfer destination memory area to all zeros.
<b>Arguments</b>	uint32_t src_addr: Transfer source memory area size uint32_t dst_addr: Transfer destination memory area address uint32_t size: Transfer source/transfer destination memory area sizes in bytes
<b>Return Value</b>	None
io_dma_init	
<b>Outline Header</b>	DMAC initialization
<b>Declaration</b>	void io_dma_init(uint32_t src_addr, uint32_t dst_addr, uint32_t dma_count)
<b>Description</b>	After clearing the DMAC module standby state, this function sets the DMAC registers.
<b>Arguments</b>	uint32_t src_addr: Transfer source memory area size uint32_t dst_addr: Transfer destination memory area address uint32_t dma_count: DMA transfer count (number of longwords to transfer)
<b>Return Value</b>	None
io_dma_start	
<b>Outline Header</b>	DMA transfer start processing
<b>Declaration</b>	void io_dma_start(void)
<b>Description</b>	Starts a DMA transfer.
<b>Arguments</b>	None
<b>Return Value</b>	None

---

**io\_dma\_poll\_end**

---

<b>Outline</b>	DMA transfer end processing
<b>Header</b>	
<b>Declaration</b>	void io_dma_poll_end(void)
<b>Description</b>	After waiting for the completion of the DMA transfer, terminates DMA transfer operation.
<b>Arguments</b>	None
<b>Return Value</b>	None

## 5.6 Flowcharts

### 5.6.1 Main Processing

Figure 5.2 shows the main processing.

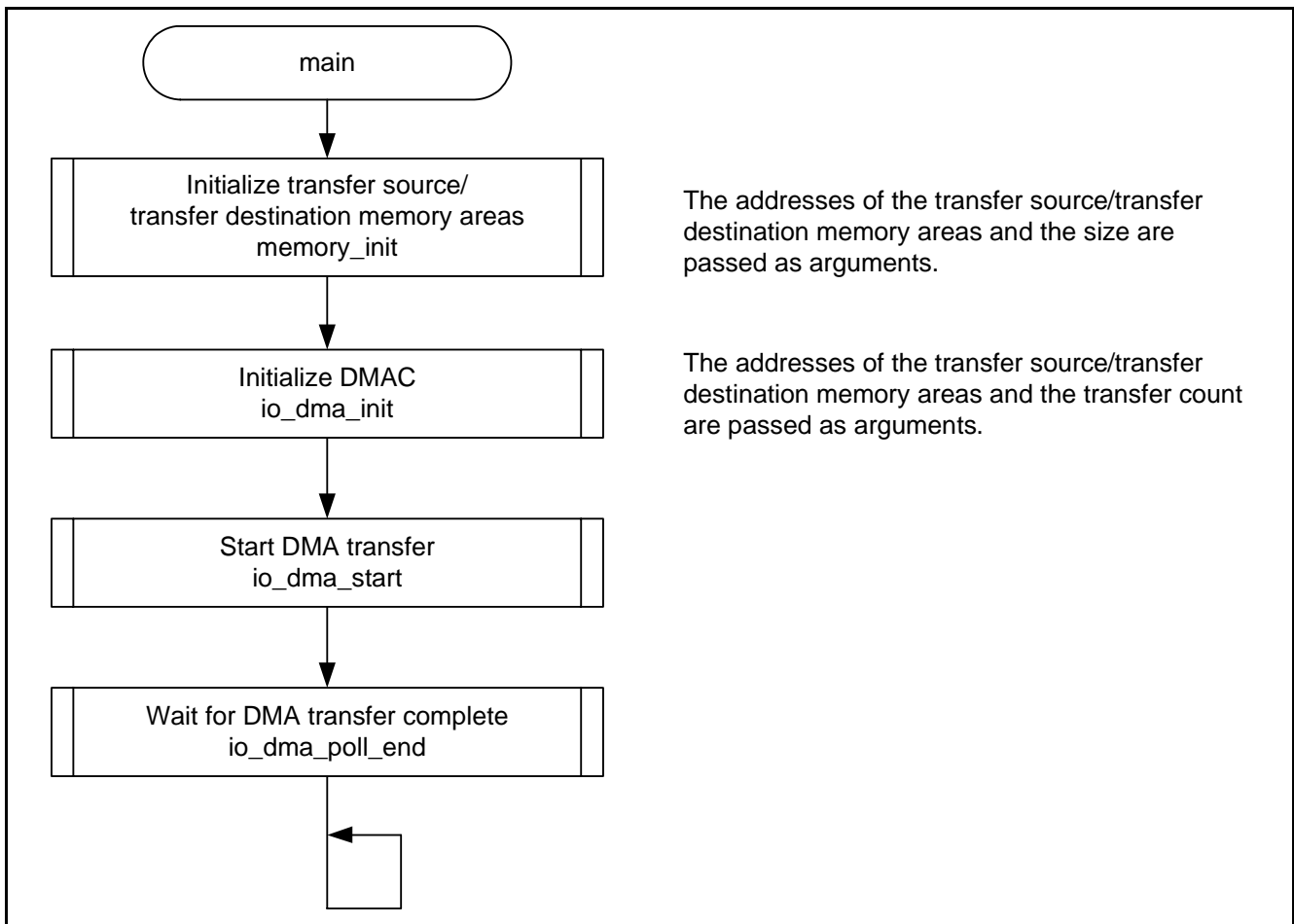
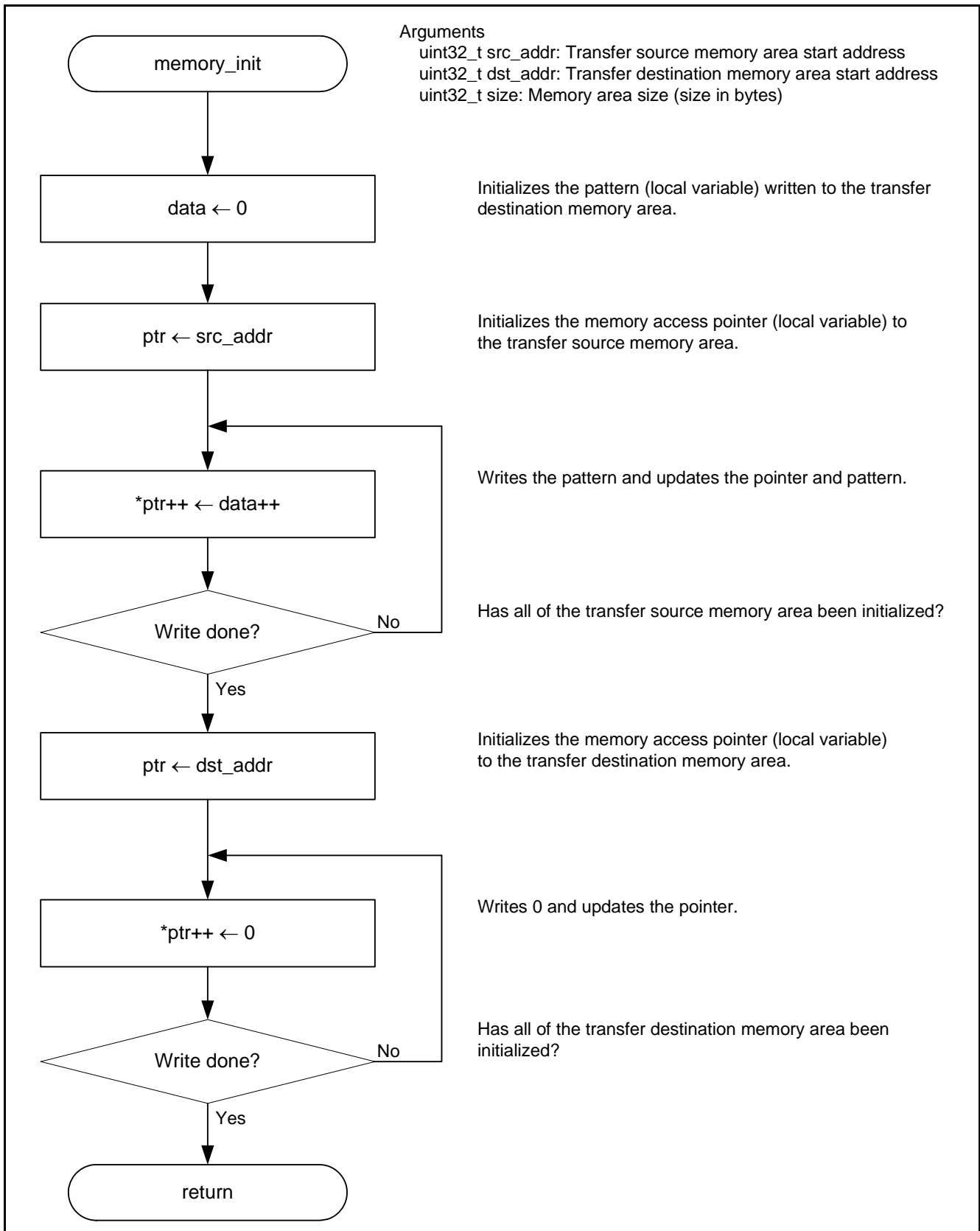

Figure 5.2 Main Processing

### 5.6.2 Transfer Source/Transfer Destination Memory Area Initialization

Figure 5.3 shows the flowchart for transfer source/transfer destination memory area initialization.



**Figure 5.3 Transfer Source/Transfer Destination Memory Area Initialization**

### 5.6.3 DMAC Initialization

Figure 5.4 shows the flowchart for DMAC initialization.

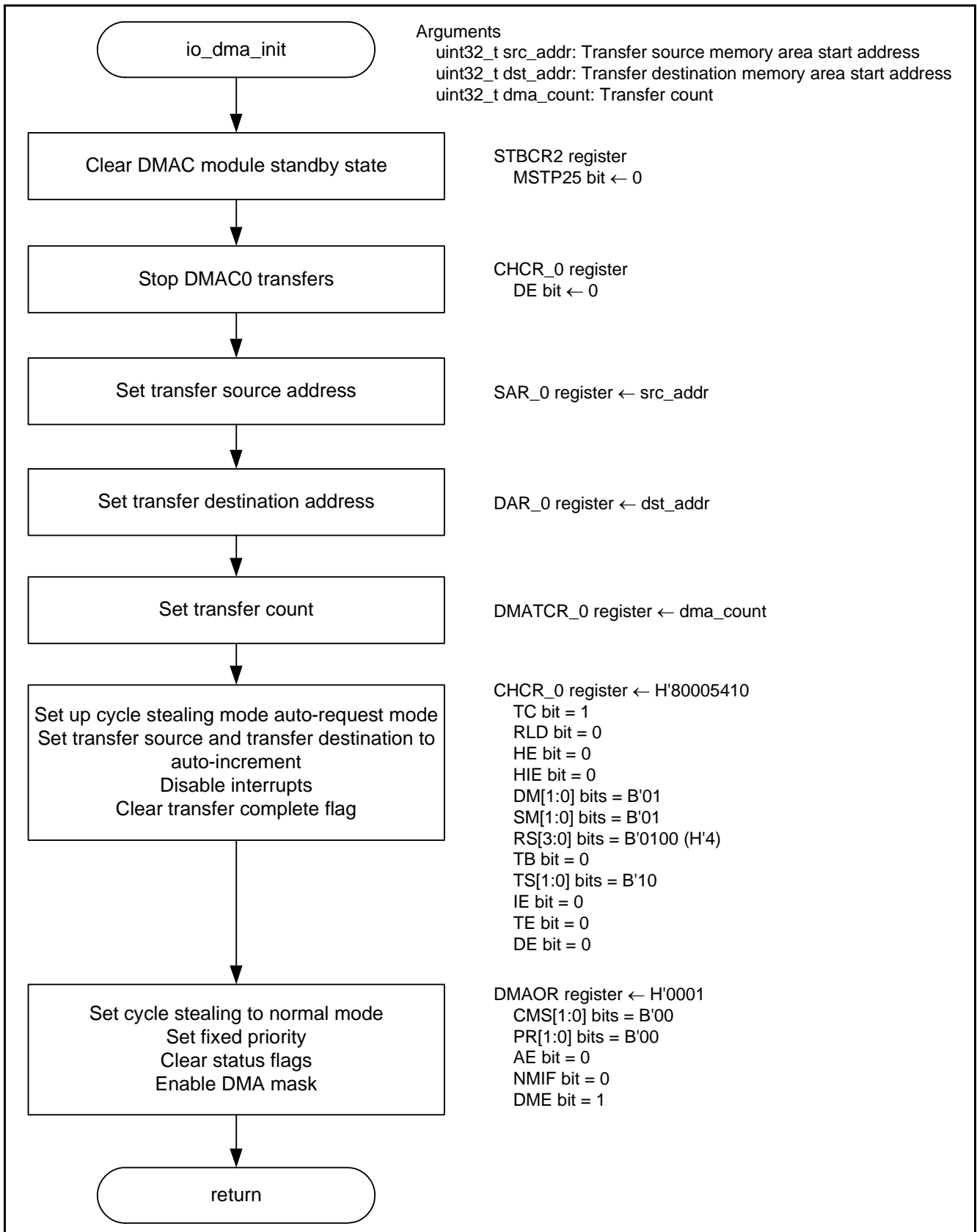

Figure 5.4 DMAC Initialization

#### 5.6.4 DMA Transfer Start Processing

Figure 5.5 shows the flowchart for DMA transfer start processing.

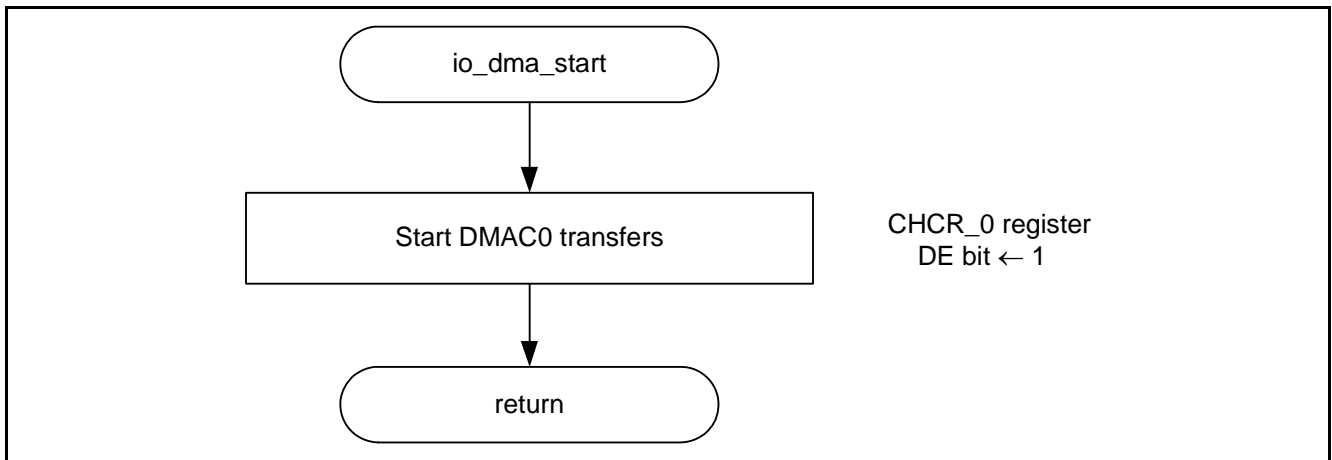

Figure 5.5 DMA Transfer Start Processing

#### 5.6.5 DMA Transfer End Processing

Figure 5.6 shows the flowchart for DMA transfer end processing.

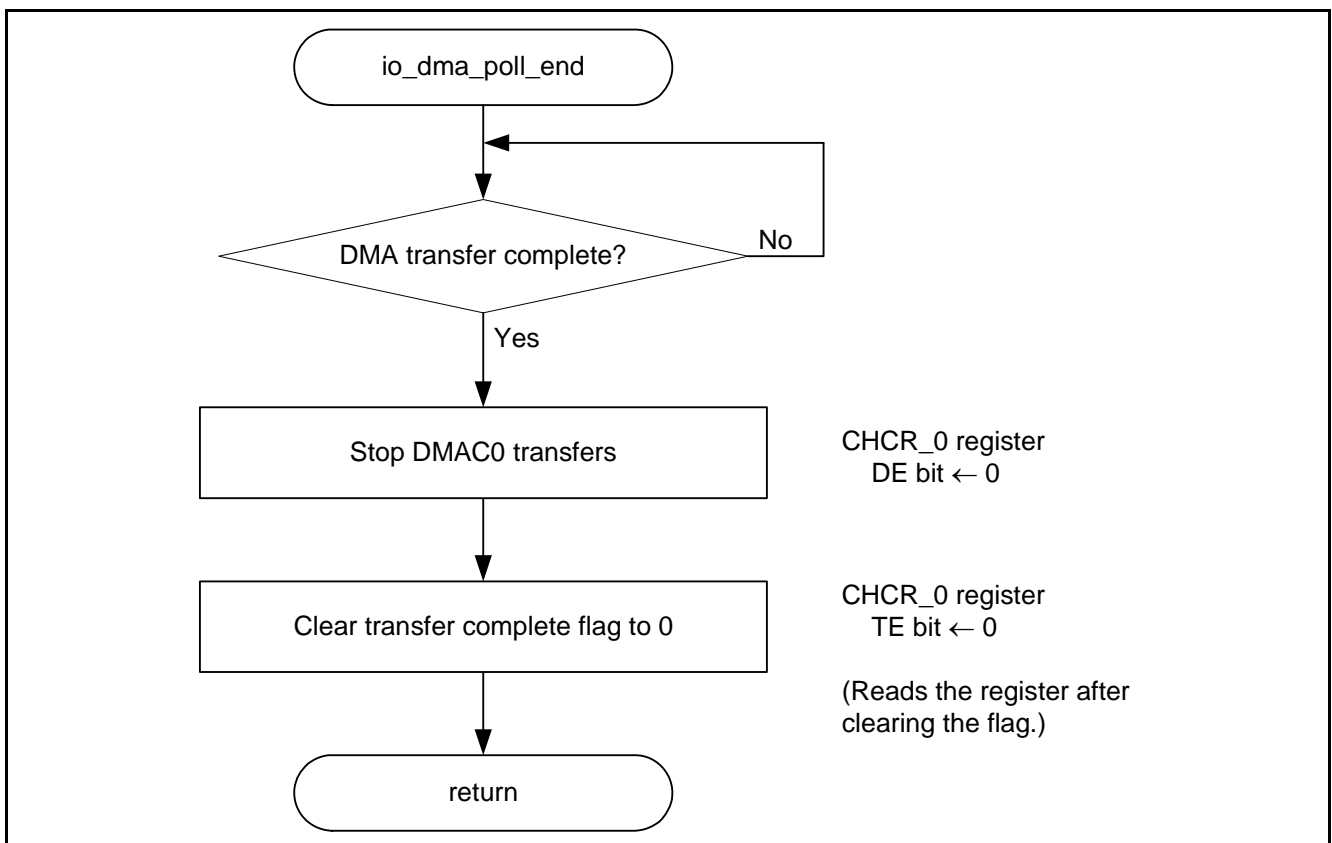

Figure 5.6 DMA Transfer End Processing

## 6. Reference Documents

- Hardware Manual:  
SH7216 Group Users Manual: Hardware Rev.3.00 (R01UH0230EJ)  
SH7239 Group Users Manual: Hardware Rev.1.00 (R01UH0086EJ)  
SH7231 Group Users Manual: Hardware Rev.2.00 (R01UH0073EJ)  
(The latest version can be downloaded from the Renesas Electronics website.)
- Software Manual  
SH-2A, SH2A-FPU User's Manual: Software Rev.4.00 (R01US0031EJ)  
(The latest version can be downloaded from the Renesas Electronics website.)

## Website and Support

Renesas Electronics website

<http://www.renesas.com>

Inquiries

<http://www.renesas.com/contact/>



<b>REVISION HISTORY</b>	SH7216/SH7239/SH7231 Groups Application Note Data Transfer Within On-Chip RAM (Cycle Stealing Mode) Using the DMAC
-------------------------	--

Rev.	Date	Description	
		Page	Summary
1.00	Dec. 07, 2012	—	First edition issued

All trademarks and registered trademarks are the property of their respective owners.

## General Precautions in the Handling of MPU/MCU Products

The following usage notes are applicable to all MPU/MCU products from Renesas. For detailed usage notes on the products covered by this manual, refer to the relevant sections of the manual. If the descriptions under General Precautions in the Handling of MPU/MCU Products and in the body of the manual differ from each other, the description in the body of the manual takes precedence.

### 1. Handling of Unused Pins

Handle unused pins in accord with the directions given under Handling of Unused Pins in the manual.

- The input pins of CMOS products are generally in the high-impedance state. In operation with an unused pin in the open-circuit state, extra electromagnetic noise is induced in the vicinity of LSI, an associated shoot-through current flows internally, and malfunctions occur due to the false recognition of the pin state as an input signal become possible. Unused pins should be handled as described under Handling of Unused Pins in the manual.

### 2. Processing at Power-on

The state of the product is undefined at the moment when power is supplied.

- The states of internal circuits in the LSI are indeterminate and the states of register settings and pins are undefined at the moment when power is supplied.

In a finished product where the reset signal is applied to the external reset pin, the states of pins are not guaranteed from the moment when power is supplied until the reset process is completed.

In a similar way, the states of pins in a product that is reset by an on-chip power-on reset function are not guaranteed from the moment when power is supplied until the power reaches the level at which resetting has been specified.

### 3. Prohibition of Access to Reserved Addresses

Access to reserved addresses is prohibited.

- The reserved addresses are provided for the possible future expansion of functions. Do not access these addresses; the correct operation of LSI is not guaranteed if they are accessed.

### 4. Clock Signals

After applying a reset, only release the reset line after the operating clock signal has become stable.

When switching the clock signal during program execution, wait until the target clock signal has stabilized.

- When the clock signal is generated with an external resonator (or from an external oscillator) during a reset, ensure that the reset line is only released after full stabilization of the clock signal. Moreover, when switching to a clock signal produced with an external resonator (or by an external oscillator) while program execution is in progress, wait until the target clock signal is stable.

### 5. Differences between Products

Before changing from one product to another, i.e. to one with a different type number, confirm that the change will not lead to problems.

- The characteristics of MPU/MCU in the same group but having different type numbers may differ because of the differences in internal memory capacity and layout pattern. When changing to products of different type numbers, implement a system-evaluation test for each of the products.

## Notice

1. Descriptions of circuits, software and other related information in this document are provided only to illustrate the operation of semiconductor products and application examples. You are fully responsible for the incorporation of these circuits, software, and information in the design of your equipment. Renesas Electronics assumes no responsibility for any losses incurred by you or third parties arising from the use of these circuits, software, or information.
2. Renesas Electronics has used reasonable care in preparing the information included in this document, but Renesas Electronics does not warrant that such information is error free. Renesas Electronics assumes no liability whatsoever for any damages incurred by you resulting from errors in or omissions from the information included herein.
3. Renesas Electronics does not assume any liability for infringement of patents, copyrights, or other intellectual property rights of third parties by or arising from the use of Renesas Electronics products or technical information described in this document. No license, express, implied or otherwise, is granted hereby under any patents, copyrights or other intellectual property rights of Renesas Electronics or others.
4. You should not alter, modify, copy, or otherwise misappropriate any Renesas Electronics product, whether in whole or in part. Renesas Electronics assumes no responsibility for any losses incurred by you or third parties arising from such alteration, modification, copy or otherwise misappropriation of Renesas Electronics product.
5. Renesas Electronics products are classified according to the following two quality grades: "Standard" and "High Quality". The recommended applications for each Renesas Electronics product depends on the product's quality grade, as indicated below.  
"Standard": Computers; office equipment; communications equipment; test and measurement equipment; audio and visual equipment; home electronic appliances; machine tools; personal electronic equipment; and industrial robots etc.  
"High Quality": Transportation equipment (automobiles, trains, ships, etc.); traffic control systems; anti-disaster systems; anti-crime systems; and safety equipment etc.  
Renesas Electronics products are neither intended nor authorized for use in products or systems that may pose a direct threat to human life or bodily injury (artificial life support devices or systems, surgical implantations etc.), or may cause serious property damages (nuclear reactor control systems, military equipment etc.). You must check the quality grade of each Renesas Electronics product before using it in a particular application. You may not use any Renesas Electronics product for any application for which it is not intended. Renesas Electronics shall not be in any way liable for any damages or losses incurred by you or third parties arising from the use of any Renesas Electronics product for which the product is not intended by Renesas Electronics.
6. You should use the Renesas Electronics products described in this document within the range specified by Renesas Electronics, especially with respect to the maximum rating, operating supply voltage range, movement power voltage range, heat radiation characteristics, installation and other product characteristics. Renesas Electronics shall have no liability for malfunctions or damages arising out of the use of Renesas Electronics products beyond such specified ranges.
7. Although Renesas Electronics endeavors to improve the quality and reliability of its products, semiconductor products have specific characteristics such as the occurrence of failure at a certain rate and malfunctions under certain use conditions. Further, Renesas Electronics products are not subject to radiation resistance design. Please be sure to implement safety measures to guard them against the possibility of physical injury, and injury or damage caused by fire in the event of the failure of a Renesas Electronics product, such as safety design for hardware and software including but not limited to redundancy, fire control and malfunction prevention, appropriate treatment for aging degradation or any other appropriate measures. Because the evaluation of microcomputer software alone is very difficult, please evaluate the safety of the final products or systems manufactured by you.
8. Please contact a Renesas Electronics sales office for details as to environmental matters such as the environmental compatibility of each Renesas Electronics product. Please use Renesas Electronics products in compliance with all applicable laws and regulations that regulate the inclusion or use of controlled substances, including without limitation, the EU RoHS Directive. Renesas Electronics assumes no liability for damages or losses occurring as a result of your noncompliance with applicable laws and regulations.
9. Renesas Electronics products and technology may not be used for or incorporated into any products or systems whose manufacture, use, or sale is prohibited under any applicable domestic or foreign laws or regulations. You should not use Renesas Electronics products or technology described in this document for any purpose relating to military applications or use by the military, including but not limited to the development of weapons of mass destruction. When exporting the Renesas Electronics products or technology described in this document, you should comply with the applicable export control laws and regulations and follow the procedures required by such laws and regulations.
10. It is the responsibility of the buyer or distributor of Renesas Electronics products, who distributes, disposes of, or otherwise places the product with a third party, to notify such third party in advance of the contents and conditions set forth in this document, Renesas Electronics assumes no responsibility for any losses incurred by you or third parties as a result of unauthorized use of Renesas Electronics products.
11. This document may not be reproduced or duplicated in any form, in whole or in part, without prior written consent of Renesas Electronics.
12. Please contact a Renesas Electronics sales office if you have any questions regarding the information contained in this document or Renesas Electronics products, or if you have any other inquiries.

(Note 1) "Renesas Electronics" as used in this document means Renesas Electronics Corporation and also includes its majority-owned subsidiaries.

(Note 2) "Renesas Electronics product(s)" means any product developed or manufactured by or for Renesas Electronics.



### SALES OFFICES

Renesas Electronics Corporation

<http://www.renesas.com>

Refer to "<http://www.renesas.com/>" for the latest and detailed information.

#### Renesas Electronics America Inc.

2880 Scott Boulevard Santa Clara, CA 95050-2554, U.S.A.  
Tel: +1-408-588-6000, Fax: +1-408-588-6130

#### Renesas Electronics Canada Limited

1101 Nicholson Road, Newmarket, Ontario L3Y 9C3, Canada  
Tel: +1-905-898-5441, Fax: +1-905-898-3220

#### Renesas Electronics Europe Limited

Dukes Meadow, Millboard Road, Bourne End, Buckinghamshire, SL8 5FH, U.K  
Tel: +44-1628-651-700, Fax: +44-1628-651-804

#### Renesas Electronics Europe GmbH

Arcadiastrasse 10, 40472 Düsseldorf, Germany  
Tel: +49-211-65030, Fax: +49-211-6503-1327

#### Renesas Electronics (China) Co., Ltd.

7th Floor, Quantum Plaza, No.27 ZhiChunLu Haidian District, Beijing 100083, P.R.China  
Tel: +86-10-8235-1155, Fax: +86-10-8235-7679

#### Renesas Electronics (Shanghai) Co., Ltd.

Unit 204, 205, AZIA Center, No.1233 Lujiazui Ring Rd., Pudong District, Shanghai 200120, China  
Tel: +86-21-5877-1818, Fax: +86-21-6887-7858 / -7898

#### Renesas Electronics Hong Kong Limited

Unit 1601-1613, 16/F., Tower 2, Grand Century Place, 193 Prince Edward Road West, Mongkok, Kowloon, Hong Kong  
Tel: +852-2886-9318, Fax: +852-2886-9022/9044

#### Renesas Electronics Taiwan Co., Ltd.

13F, No. 363, Fu Shing North Road, Taipei, Taiwan  
Tel: +886-2-8175-9600, Fax: +886-2-8175-9670

#### Renesas Electronics Singapore Pte. Ltd.

80 Bendemeer Road, Unit #06-02 Hyflux Innovation Centre Singapore 339949  
Tel: +65-6213-0200, Fax: +65-6213-0300

#### Renesas Electronics Malaysia Sdn.Bhd.

Unit 906, Block B, Menara Amcorp, Amcorp Trade Centre, No. 18, Jln Persiaran Barat, 46050 Petaling Jaya, Selangor Darul Ehsan, Malaysia  
Tel: +60-3-7955-9390, Fax: +60-3-7955-9510

#### Renesas Electronics Korea Co., Ltd.

11F., Samik Laviel' or Bldg., 720-2 Yeoksam-Dong, Kangnam-Ku, Seoul 135-080, Korea  
Tel: +82-2-558-3737, Fax: +82-2-558-5141