

---

## SH7216 Group

### MTU2 Asymmetric Complementary PWM Output (Complementary PWM Mode)

---

R01AN0672EJ0100  
Rev.1.00  
Jun 03, 2011

#### Introduction

This application note describes a sample program for outputting an asymmetric complementary pulse width modulation (PWM) waveform by using complementary PWM mode 3 (transfer at peak/trough) of the SH7216's multi-function timer pulse unit 2 (MTU2).

#### Target Device

SH7216

#### Contents

1. Preface .....	2
2. Description of the Sample Application .....	4
3. Documents for Reference .....	30

**1. Preface**

**1.1 Specifications**

The sample program described in this application note uses a complementary PWM mode function (complementary PWM mode 3, in which the duty is updated at waveform peak/trough) of multi-function timer pulse unit 2 (MTU2) to output an asymmetric complementary PWM waveform. Figure 1 shows the configuration.

The sample code includes two versions of the trigonometric function needed to calculate the PWM duty setting values.

1. Version that uses the FPU (workspace name: sh7216\_mtu2\_fpu\_unsymmetric\_3phase\_sine\_pwm)
  2. Version that does not use the FPU (workspace name: sh7216\_mtu2\_fix\_unsymmetric\_3phase\_sine\_pwm)
- Channels 3 and 4 of MTU2 are set to complementary PWM mode (complementary PWM mode 3).
  - The PWM positive phase output pins are TIOC3B, TIOC4A, and TIOC4B. The antiphase output pins corresponding to these phase output pins are TIOC3D, TIOC4C, and TIOC4D.
  - The PWM output signal is low-active.
  - In complementary PWM mode, PWM waveform output incorporates dead time (anti-short periods) to prevent overlap between the positive and antiphases. The dead time is set to 4 μsec.
  - The PWM carrier cycle is set to 400 μsec.
  - The PWM duty setting values are updated at an interrupt generated every half-cycle of the PWM carrier (peak and trough).
  - A toggle waveform synchronized with the PWM carrier cycle is output by pin TIOC3A.

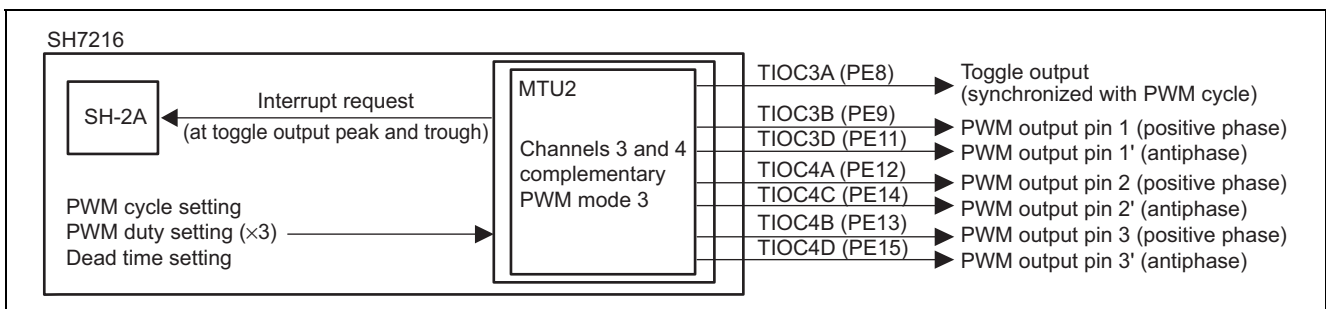

**Figure 1 Three-Phase Complementary PWM Output (Complementary PWM Mode 3)**

### 1.2 Module Used

Channels 3 and 4 of multi-function timer pulse unit 2 (MTU2)

### 1.3 Applicable Conditions

MCU:	SH7216 [R5F72167]
Operating frequencies:	Internal clock: $I\phi = 200$ MHz
	Bus clock: $B\phi = 50$ MHz
	Peripheral clock: $P\phi = 50$ MHz
	MTU2S clock: $M\phi = 100$ MHz
	AD clock: $A\phi = 50$ MHz
MCU operating mode:	Single-chip mode
Integrated development environment:	Renesas Electronics High-performance Embedded Workshop, Ver.4.08.00.011
C compiler:	Renesas Electronics SuperH RISC engine Family C/C++ Compiler Package, Ver.9.04, Release00
Compile options:	High-performance Embedded Workshop default settings
	<code>(-cpu=sh2a -include="\$(WORKSPDIR)\inc"</code>
	<code>-object="\$(CONFIGDIR)\\$(FILELEAF).obj" -debug -gbr=auto -chgincpath</code>
	<code>-errorpath -global_volatile=0 -opt_range=all -infinite_loop=0</code> <code>-del_vacant_loop=0 -struct_alloc=1 -nologo)</code>

### 1.4 Related Application Notes

Application notes related to this application note are listed below. Refer to them in conjunction with this application note.

- SH7216 Group MTU2 Three-Phase Complementary PWM Output Function (Complementary PWM Mode) (REJ06B1017)
- SH7216 Group MTU2 Three-Phase Sine Wave PWM Output (Complementary PWM Mode) (R01AN0157EJ)
- SH-2, SH-2A Fixed-Point Library (Ver. 1.01): Compiler Use Guide (REJ05J0001)

**2. Description of the Sample Application**

In this sample application, the complementary PWM mode function of multi-function timer pulse unit 2 (MTU2) is used.

**2.1 Operational Overview of Module Used**

**2.1.1 Multi-Function Timer Pulse Unit 2 (MTU2)**

Multi-function timer pulse unit 2 (MTU2) is a multi-function timer unit comprising a 6-channel 16-bit timer. Settings such as compare match or input capture can be made individually for each channel. Channels 3 and 4 can be used for 6-line PWM output control by specifying complementary PWM mode or reset synchronous mode.

For details of MTU2, see the Multi-Function Timer Pulse Unit 2 (MTU2) section in the *SH7216 Group Hardware Manual* (R01UH0230EJ0300).

Table 1 is an overview of multi-function timer pulse unit 2 (MTU2). Figure 2 is a block diagram of MTU2.

**Table 1 Overview of Multi-Function Timer Pulse Unit 2 (MTU2)**

<b>Item</b>	<b>Description</b>
Number of channels	16-bit timer × 6 channels (channels 0 to 5)
Counter clock	Each channel selectable among eight counter input clocks (four counter input clocks for channel 5)
Operation of channels 0 to 4	<ul style="list-style-type: none"> <li>• Waveform output at compare match, input capture function, counter clear operation, simultaneous write to multiple timer counters (TCNT), simultaneous clear at compare match or input capture</li> <li>• Synchronous register I/O using counter-synchronous operation, max. 12-phase PWM output through combination with synchronous operation</li> </ul>
Triggers for A/D converter	<ul style="list-style-type: none"> <li>• Ability to generate conversion start trigger for A/D converter</li> <li>• Ability to generate interrupt at counter peak/trough and to skip conversion start triggers for A/D converter in complementary PWM mode</li> </ul>
Buffered operation	<ul style="list-style-type: none"> <li>• Ability to specify register buffer operation for channels 0, 3, and 4</li> </ul>
Operating modes	<ul style="list-style-type: none"> <li>• Ability to specify PWM mode for channels 0 to 4</li> <li>• Ability to specify phase counting mode independently for channels 1 and 2</li> <li>• Ability to specify 3-phase positive and negative PWM waveform output (total 6 lines) in complementary PWM mode or reset synchronous PWM mode, using linked operation of channels 3 and 4</li> </ul>
Interrupt requests	<ul style="list-style-type: none"> <li>• 28 interrupt sources (compare match, input capture, etc.)</li> </ul>
Others	<ul style="list-style-type: none"> <li>• Cascade connection operation</li> <li>• High-speed access via internal 16-bit bus</li> <li>• Support for automatic transfer of register data</li> <li>• Ability to specify module standby mode</li> <li>• Support for dead time compensation counter function using channel 5</li> </ul>

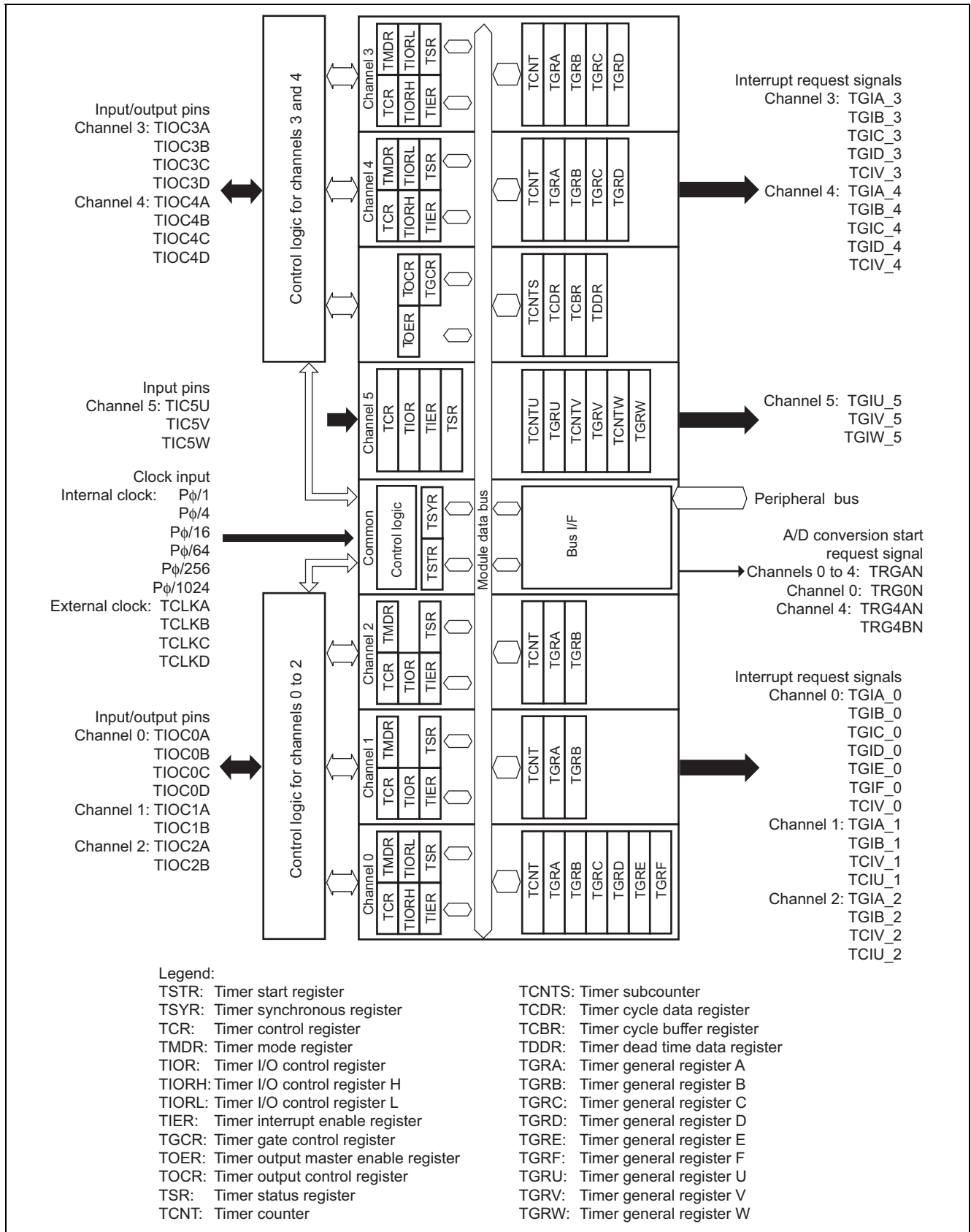

Figure 2 Block Diagram of MTU2

### 2.1.2 Complementary PWM mode

Multi-function timer pulse unit 2 (MTU2) can be set to complementary PWM mode, in which channels 3 and 4 are used in combination. In complementary PWM mode, three-phase non-overlapping positive and negative PWM waveforms are output. It is also possible to specify PWM waveform output with no dead time to prevent overlapping. Pins TIOC3B, TIOC3D, TIOC4A, TIOC4B, TIOC4C, and TIOC4D function as PWM output pins in complementary PWM mode. The TIOC3A pin can be set for toggle output synchronized with the PWM cycle.

Figure 3 shows the configuration of channels 3 and 4 of multi-function timer pulse unit 2 (MTU2) in complementary PWM mode.

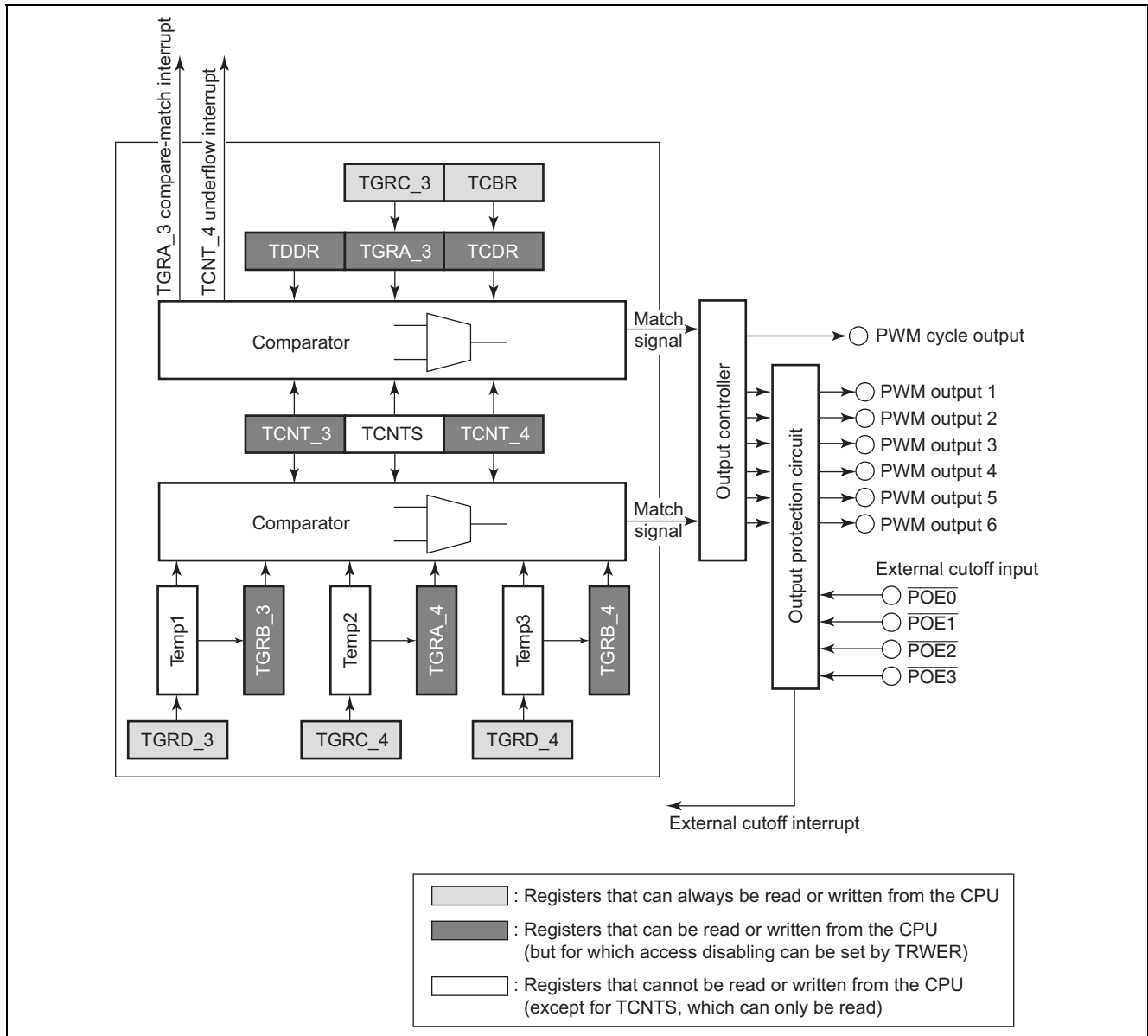

Figure 3 Block Diagram of Channels 3 and 4 in Complementary PWM Mode

The channel 3 and channel 4 register functions in complementary PWM mode are described below.

- Timer general register A\_3 (TGRA\_3) operates as a compare register. The upper limit value for TCNT\_3 (1/2 carrier cycle + dead time) is set in TGRA\_3. To change the value of this register while the timer is operating, set the new value in timer general register C\_3 (TGRC\_3).
- Timer general register B\_3 (TGRB\_3) operates as a compare register. The duty of the PWM waveforms output by pins TIOC3B and TIOC3D is set in TGRB\_3. To change the value of this register while the timer is operating, set the new value in timer general register D\_3 (TGRD\_3).
- Timer general register C\_3 (TGRC\_3) operates as the buffer register for TGRA\_3. While the timer is operating, TGRA\_3 is updated to reflect values set in TGRC\_3.
- Timer general register D\_3 (TGRD\_3) operates as the buffer register for TGRB\_3. While the timer is operating, TGRB\_3 is updated to reflect values set in TGRD\_3.
- Timer general register A\_4 (TGRA\_4) operates as a compare register. The duty of the PWM waveforms output by pins TIOC4A and TIOC4C is set in TGRA\_4. To change the value of this register while the timer is operating, set the new value in timer general register C\_4 (TGRC\_4).
- Timer general register B\_4 (TGRB\_4) operates as a compare register. The duty of the PWM waveforms output by pins TIOC4B and TIOC4D is set in TGRB\_4. To change the value of this register while the timer is operating, set the new value in timer general register D\_4 (TGRD\_4).
- Timer general register C\_4 (TGRC\_4) operates as the buffer register for TGRA\_4. While the timer is operating, TGRA\_4 is updated to reflect values set in TGRC\_4.
- Timer general register D\_4 (TGRD\_4) operates as the buffer register for TGRB\_4. While the timer is operating, TGRB\_4 is updated to reflect values set in TGRD\_4.
- Temporary registers 1, 2, and 3 (Temp1, 2, and 3) occupy a position between the buffer registers and compare registers. Data written to the buffer register is transferred to the temporary register and then to the compare register. The temporary registers cannot be accessed by the CPU.
- Timer counter\_3 (TCNT\_3) is a 16-bit counter. TCNT\_3 starts counting down when a compare match with TGRA\_3 occurs, and it starts counting up when a compare match with the timer dead time data register (TDDR) occurs.
- Timer counter\_4 (TCNT\_4) is a 16-bit counter. TCNT\_4 starts counting down when a compare match with the timer cycle data register (TCDR) occurs, and it starts counting up when the value of TCNT\_4 reaches H'0000.
- The timer dead time data register (TDDR) is a 16-bit readable/writable register. TDDR specifies the dead time for the PWM waveforms.
- The timer cycle data register (TCDR) is a 16-bit register. TCDR specifies a value equal to one-half the PWM carrier cycle.
- The timer cycle buffer register (TCBR) operates as the buffer register for TCDR. While the timer is operating, TCDR is updated to reflect values set in TCBR.

## 2.2 Operation of the Sample Program

### 2.2.1 Settings for Operation of the Sample Program

In this application note, channels 3 and 4 of multi-function timer pulse unit 2 (MTU2) are set to complementary PWM mode 3 and output a three-phase asymmetric waveform in the first and second halves of the carrier cycle. A sine wave is output for all three phases in the first carrier half-cycle. In the second carrier half-cycle, PWM output 1 stays high, PWM output 2 stays low, and PWM output 3 is a sine wave. In addition, toggle output synchronized with the PWM carrier cycle is generated.

Table 2 lists the setting conditions for complementary PWM mode operation. Figure 4 shows a sample of output waveforms in complementary PWM mode.

**Table 2 Setting for Operation in Complementary PWM Mode**

Item	Description
Channels in use	Channels 3 and 4
Operating mode	Complementary PWM mode 4 (data transfer at counter peaks and troughs)
Functions of pins	<ul style="list-style-type: none"> <li>• TIOC3A pin: Toggle output synchronized to PWM cycle</li> <li>• TIOC3B pin: PWM output 1 (positive phase waveform)</li> <li>• TIOC3D pin: PWM output 1' (PWM output 1 antiphase waveform)</li> <li>• TIOC4A pin: PWM output 2 (positive phase waveform)</li> <li>• TIOC4C pin: PWM output 2' (PWM output 2 antiphase waveform)</li> <li>• TIOC4B pin: PWM output 3 (positive phase waveform)</li> <li>• TIOC4D pin: PWM output 3' (PWM output 3 antiphase waveform)</li> </ul>
Active level	<ul style="list-style-type: none"> <li>• Positive phase output: Low-active output</li> <li>• Antiphase output: Low-active output</li> </ul>
Counter clock	12.5 MHz (4 cycles of P $\phi$ clock)
PWM carrier cycle	400 $\mu$ s (carrier frequency: 2.5 kHz)
Dead time	4 $\mu$ s
PWM duty	<ul style="list-style-type: none"> <li>• The phases of the PWM output 1, 2, and 3 waveforms are each shifted <math>2\pi/3</math>, relative to the adjacent waveforms, and their initial phases are 0, <math>2\pi/3</math>, and <math>4\pi/3</math>.</li> <li>• The PWM duty setting is updated in the buffer register each time TGRA_3 compare-match interrupt handling and TCNT_4 overflow interrupt handling occur.</li> </ul>
Interrupts	<ul style="list-style-type: none"> <li>• TGRA_3 compare match interrupt A compare match with TGRA_3 occurs every PWM carrier cycle.</li> <li>• TCNT_4 overflow interrupt A TCNT_4 overflow (H'0001 <math>\rightarrow</math> H'0000)*<sup>1</sup> occurs every PWM carrier cycle.</li> </ul>

Note: 1. In complementary PWM mode, a TCNT\_4 overflow interrupt is also generated when the TCNT\_4 value underflows (H'0001  $\rightarrow$  H'0000).



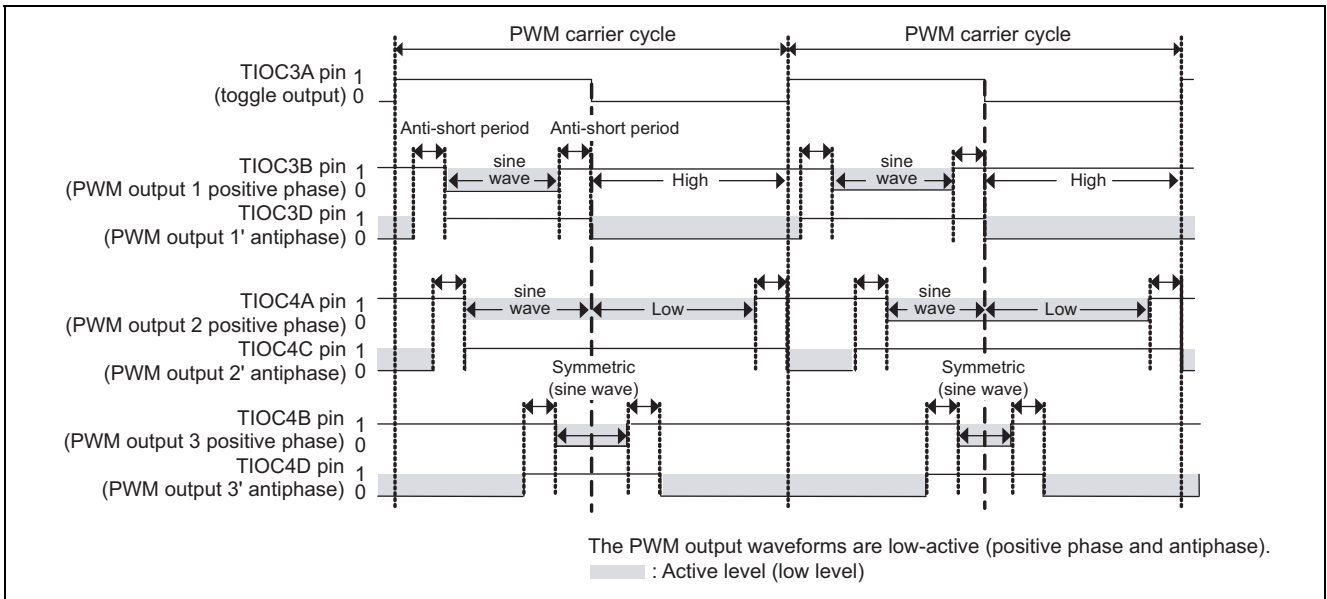

Figure 4 Output Waveforms in Complementary PWM Mode Operation

### 2.2.2 Description of Operation by the Sample Program

#### (1) Operation of Timer Counters

Figure 5 shows the operation timer counter in complementary PWM mode. Counters TCNT\_3 and TCNT\_4, which correspond to channel 3 and channel 4, each count up or down. The initial value of counter TCNT\_3 is set to the same value as the TDDR register, and the initial value of counter TCNT\_4 is set to H'0000. Channels 3 and 4 start timer count operation simultaneously.

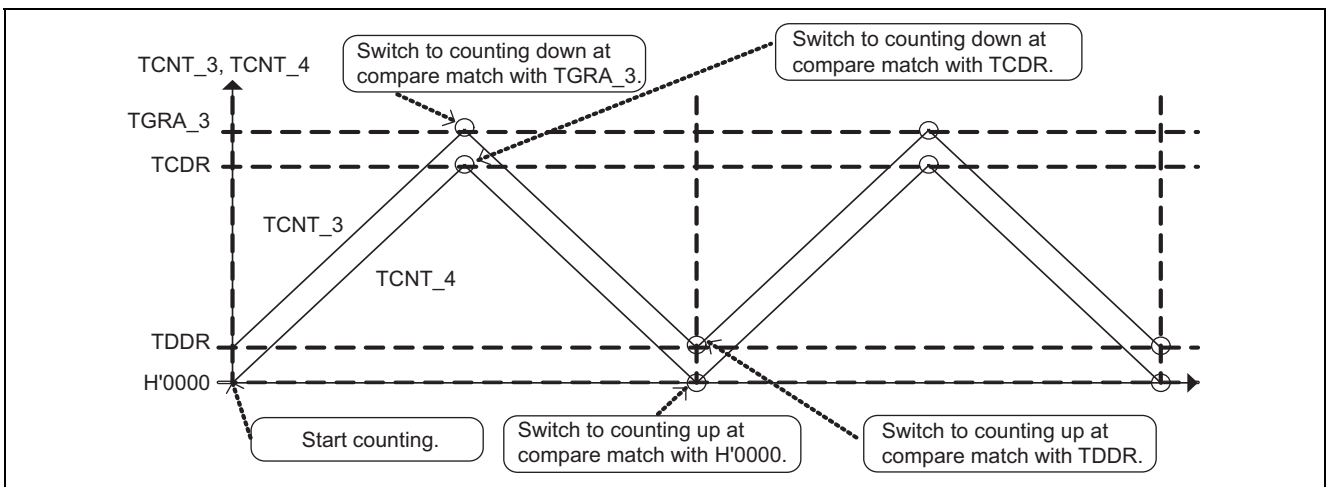
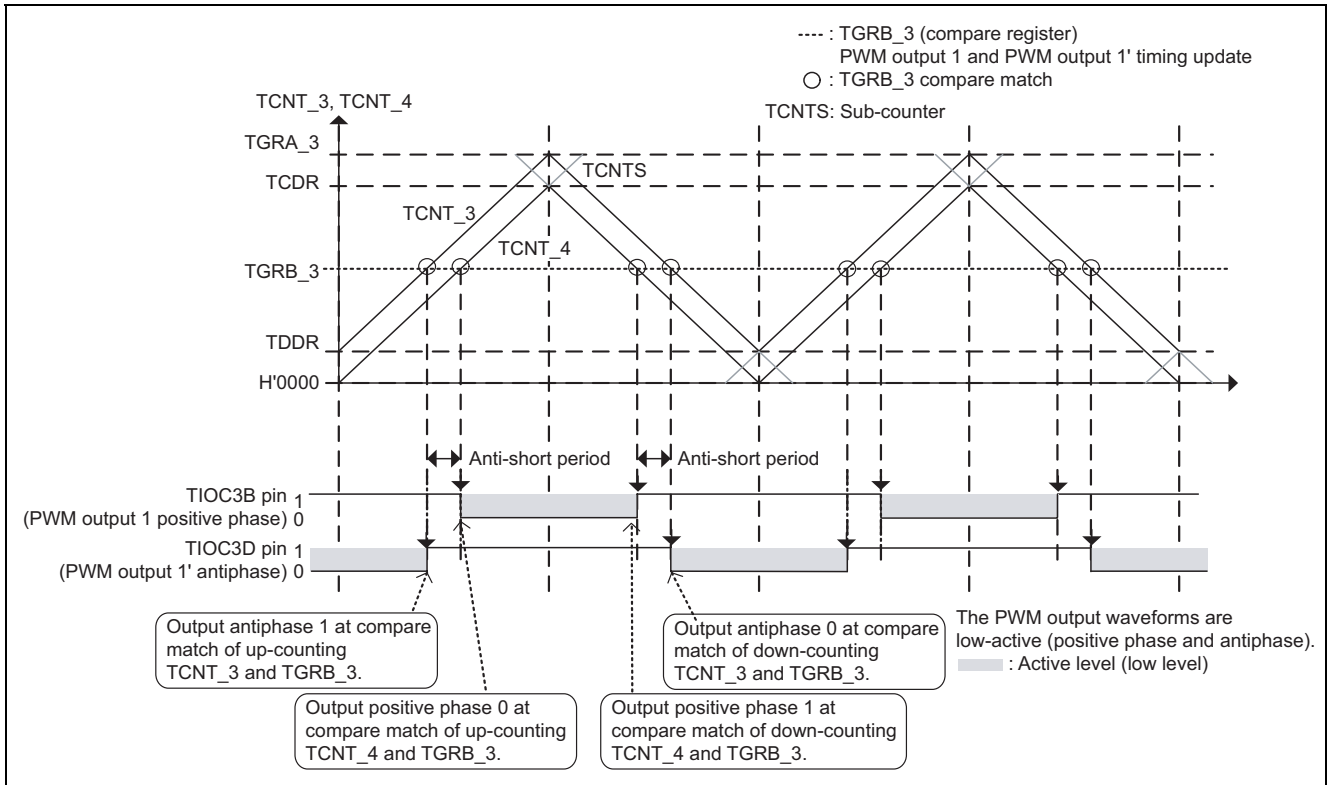

Figure 5 Operation of Timer Counters

**(2) PWM Output Waveforms**

The three-phase complementary PWM output waveforms are controlled by using the compare match function with timer counters (TCNT\_3 and TCNT\_4) and compare registers (TGRB\_3, TGRA\_4, and TGRB\_4). When the value of a register matches the value of a counter, positive phase output and antiphase output are generated according to the values set in bits OLSN and OLSP in the timer output control register (TOCR).

Figure 6 shows the output waveforms for single-phase (positive phase, antiphase) complementary PWM output. The positive phase and antiphase output signals are controlled by using the compare match function with timer counters (TCNT\_3 and TCNT\_4) and a compare register (TGRB\_3).



**Figure 6 Complementary PWM Output Waveforms**

(3) Changing the PWM Duty

Three buffer registers, TGRD\_3, TGRC\_4, and TGRD\_4, are used to update PWM duty values.

Figure 7 shows the PWM duty update timing for PWM output 1. In the reference program, the TGRA\_3 compare match interrupt (counter peak interrupt) handler and TCNT\_4 overflow interrupt (counter peak interrupt) handler make register settings after calculating the PWM duty setting update values. The CPU sets TGRD\_3 to the value of TGRA\_3 at TCNT\_4 overflow interrupt handling and PWM output 1 stays high.

When changing the duty, always set TGRD\_4 last. Always execute a write to TGRD\_4 after writing updated register data, even if the TGRD\_4 data value does not change.

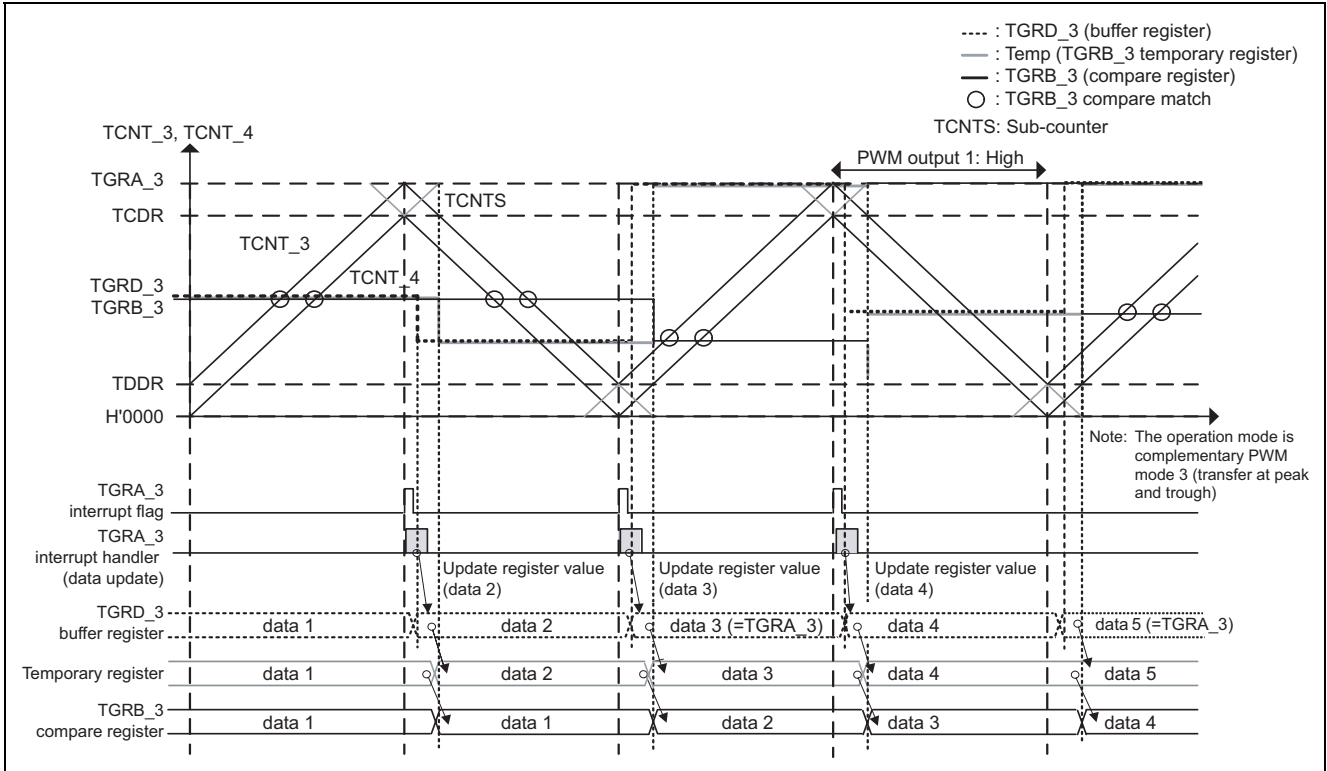

Figure 7 PWM Duty Update Timing (PWM Output 1)

**(4) PWM Duty Update Value Calculation**

Figure 8 shows the setting values of compare registers TGRB\_3, TGRA\_4, and TGRB\_4, which are updated at the counter peak each carrier cycle.

At each compare-match interrupt, which occurs at the counter peak each carrier cycle, the *angl\_cnt* variable is incremented by 1, and the *angl\_cnt* value is used to calculate the setting values for the compare registers according to the equations below. Note that settings are made to the compare registers via buffer registers. *ROT\_CYCLE* is the sine wave period and is set to 50 in the sample program. The value of *TGRA\_3* is 2550.

$$\begin{aligned}
 (TGRB\_3) &= \frac{(TGRA\_3)}{2} \left\{ \sin\left(2\pi \frac{angl\_cnt}{ROT\_CYCLE}\right) + 1 \right\} \\
 (TGRA\_4) &= \frac{(TGRA\_3)}{2} \left\{ \sin\left(2\pi \frac{angl\_cnt}{ROT\_CYCLE} - \frac{2}{3}\pi\right) + 1 \right\} \\
 (TGRB\_4) &= \frac{(TGRA\_3)}{2} \left\{ \sin\left(2\pi \frac{angl\_cnt}{ROT\_CYCLE} - \frac{4}{3}\pi\right) + 1 \right\}
 \end{aligned}$$

The sample code includes two versions of the trigonometric function needed to perform the calculations.

1. Version that uses the FPU (workspace name: *sh7216\_mtu2\_fpu\_unsymmetric\_3phase\_sine\_pwm*)
2. Version that does not use the FPU (workspace name: *sh7216\_mtu2\_fix\_unsymmetric\_3phase\_sine\_pwm*)

Function 1. includes the numeric calculation libraries (standard include files) *math.h* and *mathf.h*, and it uses double and float type variables to perform the calculations. Function 2. includes the fixed-point library *fixmath.h*, and it uses *FIX16* type variables to perform the calculations. For details of *FIX16* type variables and the fixed-point library, see *SH-2, SH-2A Fixed-Point Library (Ver. 1.01): Compiler Use Guide* (REJ05J0001).

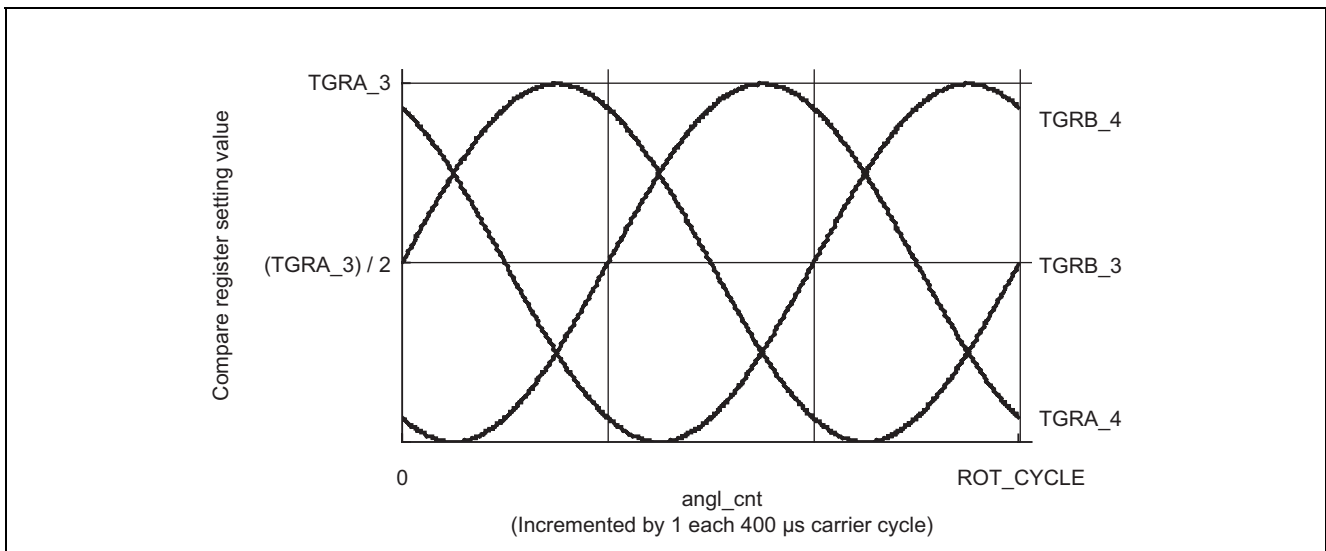

**Figure 8 Setting Values of Compare Registers TGRB\_3, TGRA\_4, and TGRB\_4**

**(5) Output Toggling in Synchronization with PWM Cycle**

Figure 9 shows the operations for toggling of an output level in synchronization with the PWM cycle. The PSYE bit in the timer output control register (TOCR) is set to 1 to select toggling of an output in synchronization with the PWM carrier cycle. Toggling is of the signal on the TIOC3A pin. The initial output is low-level.

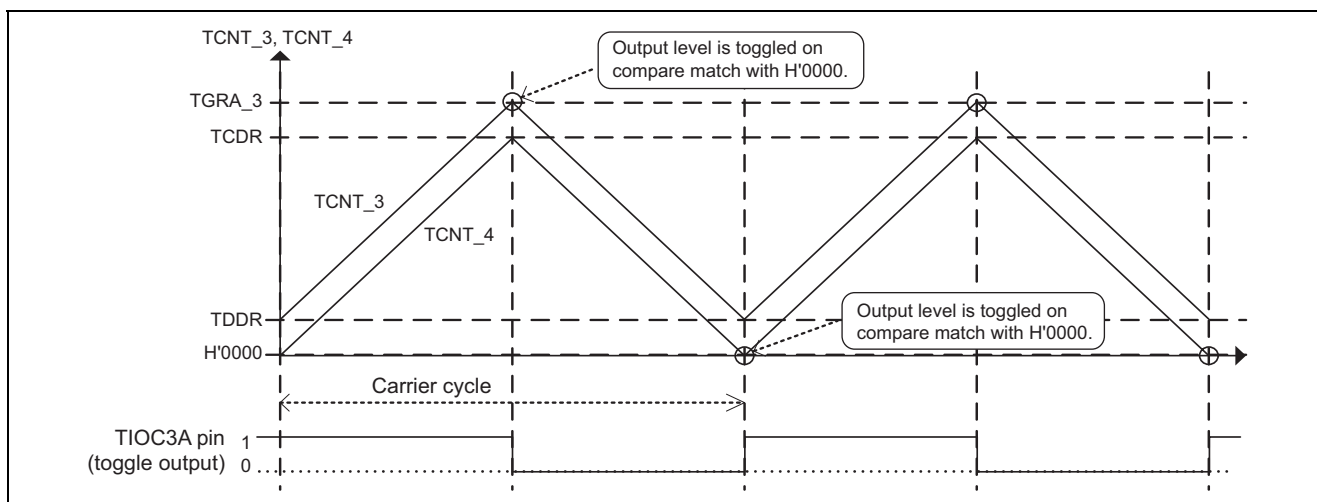

**Figure 9 Operation for Toggling an Output in Synchronization with the PWM Cycle**

**2.2.3 Example of Output with User-Defined PWM Duty**

Table 3 summarizes single-phase positive phase and antiphase output operation, showing the relationship between different PWM duty setting values and the resulting positive phase and antiphase output waveforms.

In complementary PWM mode, the output levels are fixed when the value of the compare register (TGRB\_3) is H'0000, with positive phase output duty 0% and antiphase output duty 100%. The output levels are also fixed when the value of the compare register (TGRB\_3) is equal to or greater than the setting value of the TGRA\_3 register, with positive phase output duty 100% and antiphase output duty 0%. Figure 10 shows examples of positive phase and antiphase output waveforms.

Note that when the PWM duty is changed, the new setting value is not written directly to the compare register. Instead, it must be written to the buffer register, after which the compare register is updated via the buffer register.

**Table 3 Example of PWM Duty Settings and Output Waveforms**

TGRB_3 Register Value	Output Waveform* <sup>1</sup>		Waveform Figure
	Positive Phase Output (TIOC3B Pin)	Antiphase Output (TIOC3D Pin)	
$TGRB_3 \geq TGRA_3$	Output duty 100%	Duty 0%	Figure 10 (a)
$TGRA_3 > TGRB_3 > TCDR$	Output duty 100%	$0 < \text{High width} < \text{Double the anti-short period}$	Figure 10 (b)
$TGRB_3 = TCDR$	Output duty 100%	High width = Double the anti-short period	Figure 10 (c)
$TCDR > TGRB_3 > TDDR$	Duty 100% > High width > Double the anti-short period	High width = Positive phase low width + double the anti-short period	Figure 10 (d)
$TGRB_3 = TDDR$	Pulse width = Double the anti-short period	Output duty 100%	Figure 10 (e)
$TDDR > TGRB_3 > H'0000$	Double the anti-short period > High width > 0	Output duty 100%	Figure 10 (f)
$TGRB_3 = H'0000$	Duty 0%	Output duty 100%	Figure 10 (g)

Note: 1. The PWM output active level is set to low. The example is for single-phase (positive phase, antiphase) complementary PWM output.

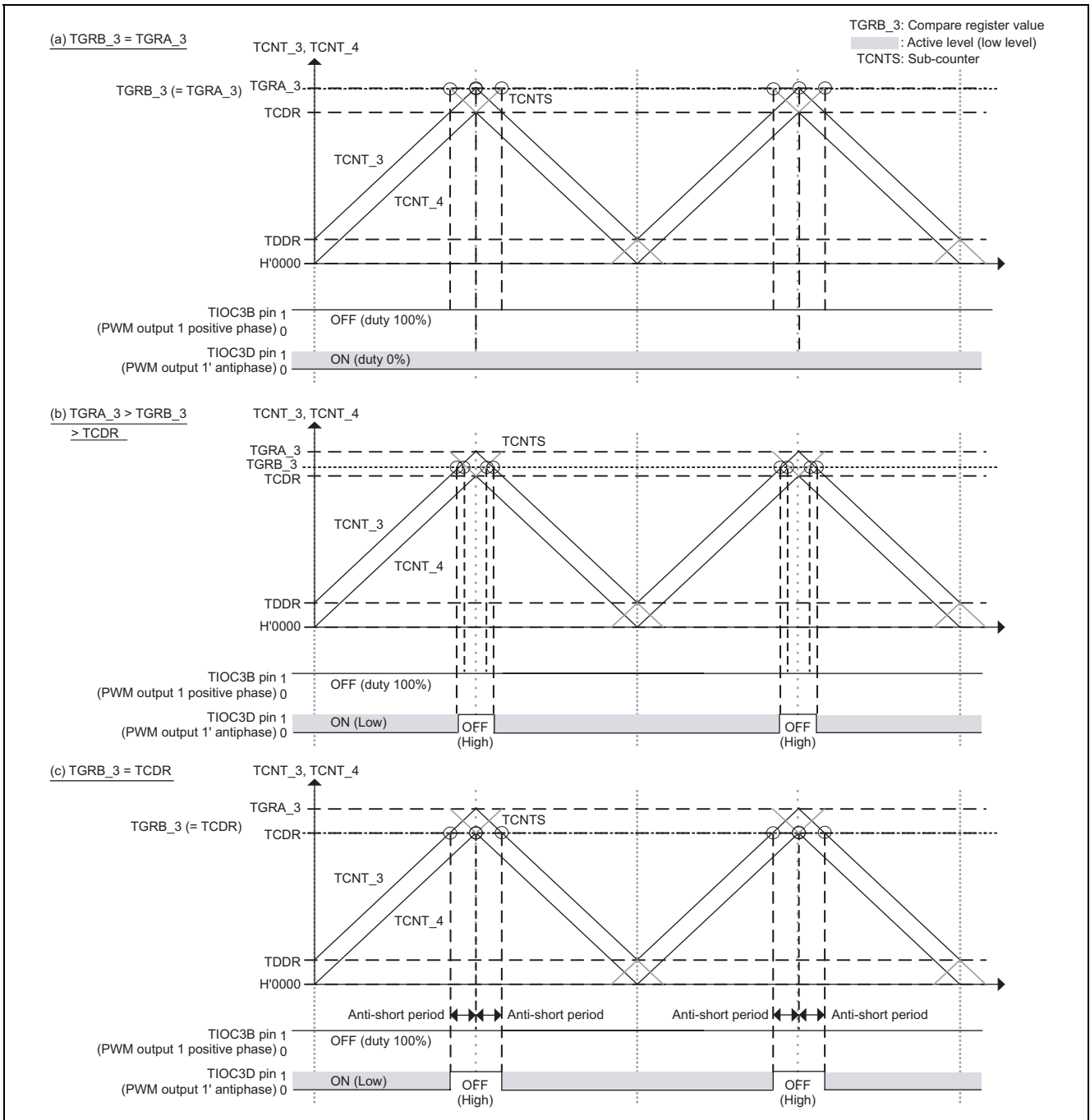

Figure 10 (a), (b), (c) Examples of PWM Waveform Output

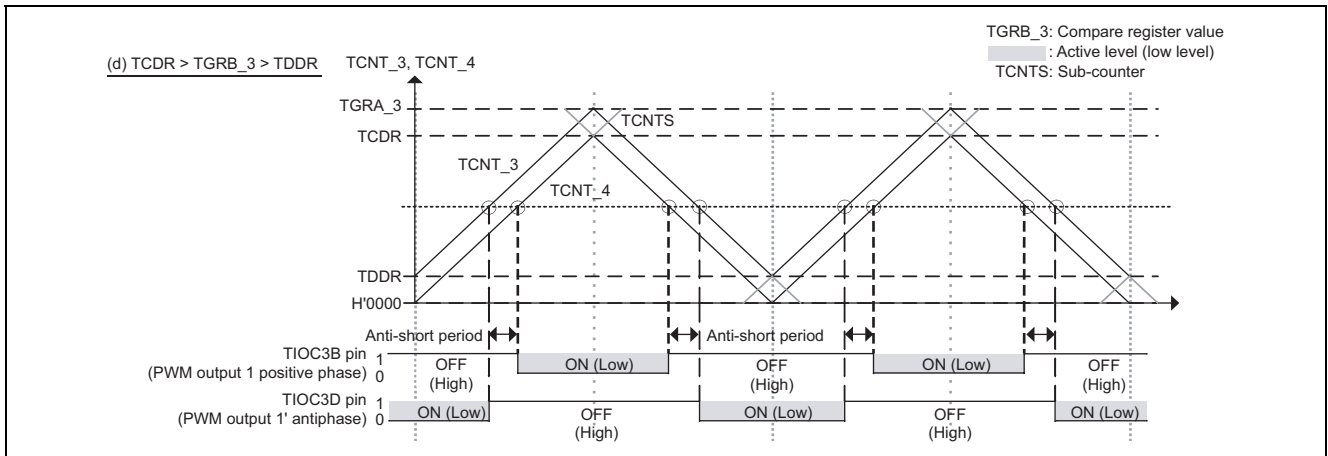
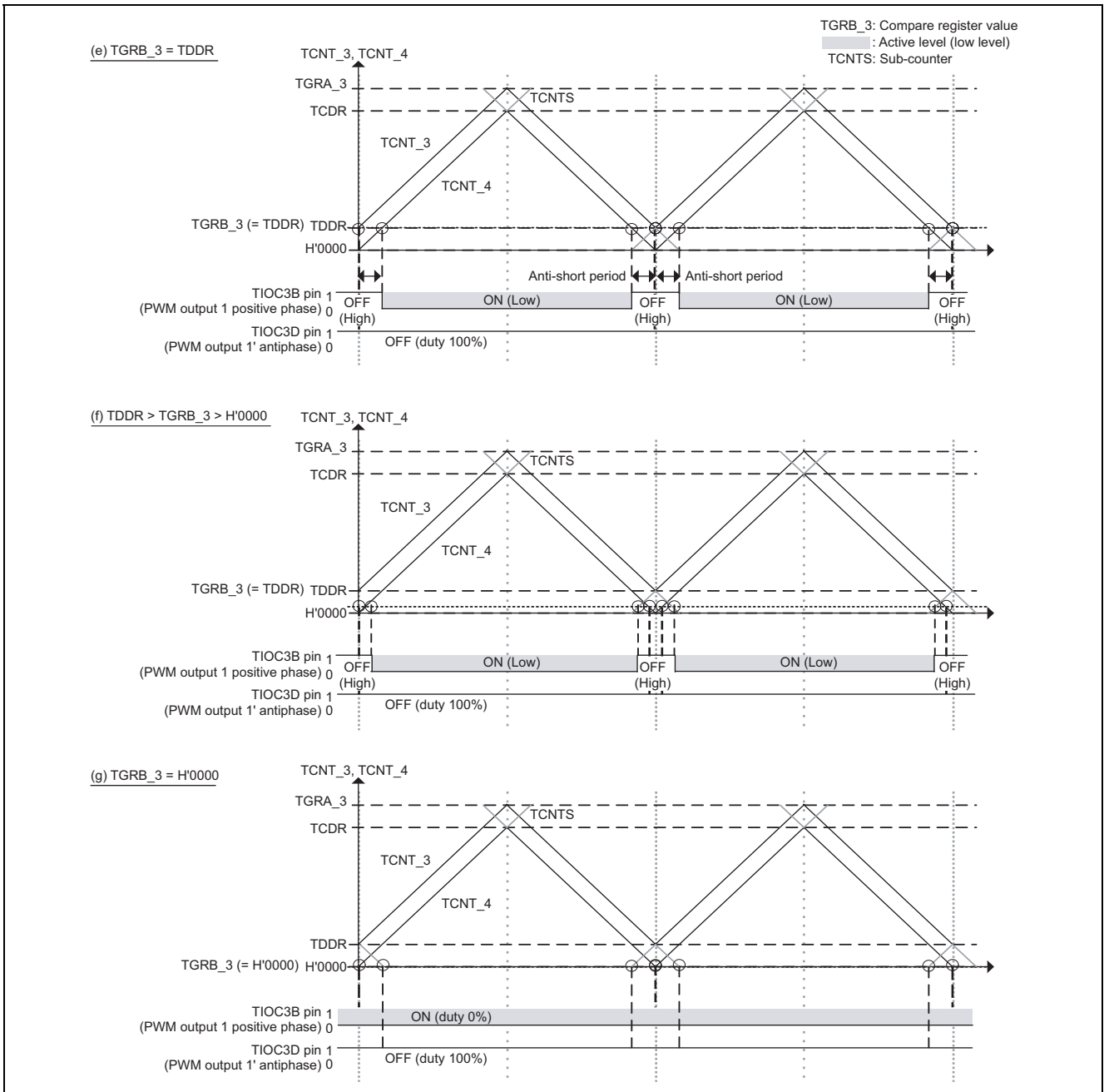

Figure 10 (d) Example of PWM Waveform Output





## 2.3 Configuration of the Sample Program

### 2.3.1 Description of Functions

Table 4 lists functions used in this sample program.

**Table 4 Functions Used**

Function Name	Description
main()	Main function Makes initial settings for each module and makes timer start settings for multi-function timer pulse unit 2 (MTU2).
stbcr_init()	Standby setting Cancels MTU2 module standby.
mtu2_init()	Makes MTU2 (channels 3 and 4) initial settings. Specifies reset-synchronized PWM mode.
pfm_init()	Makes initial settings for the pin function controller (PFC). Sets MTU2-related pins to timer pin function.
int_mtu2_tgi3a()	Handler for the MTU2 (channel 3) TGRA_3 compare match interrupt. Increments the angl_cnt variable. Stores the values calculated from the angl_cnt value in the buffer registers. The interrupt is generated once every PWM carrier cycle (400 μsec).
int_mtu2_tgi4v()	Handler for the MTU2 (channel 4) TCNT_4 overflow interrupt. Sets the buffer register to a value equal to half a carrier cycle plus dead time so that a high-level signal is output from PWM output 1. Sets the buffer register to H'0000 so that a low-level signal is output from PWM output 2. Sets the buffer register to the value calculated by the MTU2 (channel 3) TGRA_3 compare match handler so that a sine wave is output from PWM output 3. The interrupt is generated once every PWM carrier cycle (400 μsec).
calc_tgr_value_by_double()* <sup>1</sup>	Uses the math.h calculation library and double type variables to calculate the setting values for the compare registers, and stores the values in the array pul_pwm_duty[].
calc_tgr_value_by_float()* <sup>1</sup>	Uses the mathf.h calculation library and float type variables to calculate the setting values for the compare registers, and stores the values in the array pul_pwm_duty[].
calc_tgr_value_by_fix16()* <sup>2</sup>	Uses the fixmath.h calculation library and FIX16 type variables to calculate the setting values for the compare registers, and stores the values in the array pul_pwm_duty[].

Notes: 1. Only used by the version that uses the FPU  
(workspace name: sh7216\_mtu2\_fpu\_undefined\_3phase\_sine\_pwm).  
2. Only used by the version that does not use the FPU  
(workspace name: sh7216\_mtu2\_fix\_undefined\_3phase\_sine\_pwm).

**2.3.2 Variable and Constants Used**

Table 5 lists the variables and constants used in the sample program.

**Table 5 Variable and Constants Used**

Variable Name	Description	Used by Function
rot_dir	This variable determines whether the variable angl_cnt is incremented or decremented. The initial value is 0. A value of 0 indicates increment and 1 indicates decrement. Note that only the increment setting is used by the sample program.	<ul style="list-style-type: none"> <li>int_mtu2_tgi3a()</li> </ul>
angl_cnt	This variable is incremented by 1 in the int_mtu2_tgi3a() function. The initial value is 0 and the period is 5000.	<ul style="list-style-type: none"> <li>int_mtu2_tgi3a()</li> </ul>
type_select* <sup>1</sup>	This variable determines whether double or float type variables are used for calculations by the trigonometric function. The initial value is 0. A value of 0 indicates double type and 1 indicates float type variables are used in calculations.	<ul style="list-style-type: none"> <li>int_mtu2_tgi3a()</li> </ul>
angl_d* <sup>1</sup>	The sine wave PWM angle expressed in circular measure (double type).	<ul style="list-style-type: none"> <li>calc_tgr_value_by_double()</li> </ul>
angl_f* <sup>1</sup>	The sine wave PWM angle expressed in circular measure (float type).	<ul style="list-style-type: none"> <li>calc_tgr_value_by_float()</li> </ul>
angl_fix16* <sup>2</sup>	The sine wave PWM angle expressed in circular measure (FIX16 type).	<ul style="list-style-type: none"> <li>calc_tgr_value_by_fix16()</li> </ul>
pul_pwm_duty[]	PWM duty setting value. Each element corresponds to specific pins, as follows. [0] PWM1 output (pins TIOC3B and TIOC3D) (Stored in TGRD_3 register.) [1] PWM2 output (pins TIOC4A and TIOC4C) (Stored in TGRC_4 register.) [2] PWM3 output (pins TIOC4B and TIOC4D) (Stored in TGRD_4 register.)	<ul style="list-style-type: none"> <li>mtu2_init()</li> <li>int_mtu2_tgi3a()</li> <li>int_mtu2_tgi4v()</li> <li>calc_tgr_value_by_double()</li> <li>calc_tgr_value_by_float()</li> <li>calc_tgr_value_by_fix16()</li> </ul>
Pi2_fix16* <sup>2</sup>	A FIX16 type constant with a value of $2\pi$ .	<ul style="list-style-type: none"> <li>calc_tgr_value_by_fix16()</li> </ul>
One_3rd_period_fix16* <sup>2</sup>	A FIX16 type constant with a value of $2\pi/3$ .	<ul style="list-style-type: none"> <li>calc_tgr_value_by_fix16()</li> </ul>
Rot_cycle_fix16* <sup>2</sup>	A FIX16 type constant with a value of 5000.	<ul style="list-style-type: none"> <li>calc_tgr_value_by_fix16()</li> </ul>
Half_pul_cycle_fix16* <sup>2</sup>	A FIX16 type constant with a value of $(TGRA_3)/2 = 2550$ .	<ul style="list-style-type: none"> <li>calc_tgr_value_by_fix16()</li> </ul>

- Notes: 1. Only used by the version that uses the FPU (workspace name: sh7216\_mtu2\_fpu\_unsymmetric\_3phase\_sine\_pwm).  
2. Only used by the version that does not use the FPU (workspace name: sh7216\_mtu2\_fix\_unsymmetric\_3phase\_sine\_pwm).

## 2.4 Procedure for Setting the Module Used

The processing sequences of the sample program are shown below.

### 2.4.1 Main Function

Figure 11 shows the processing sequence of the main function.

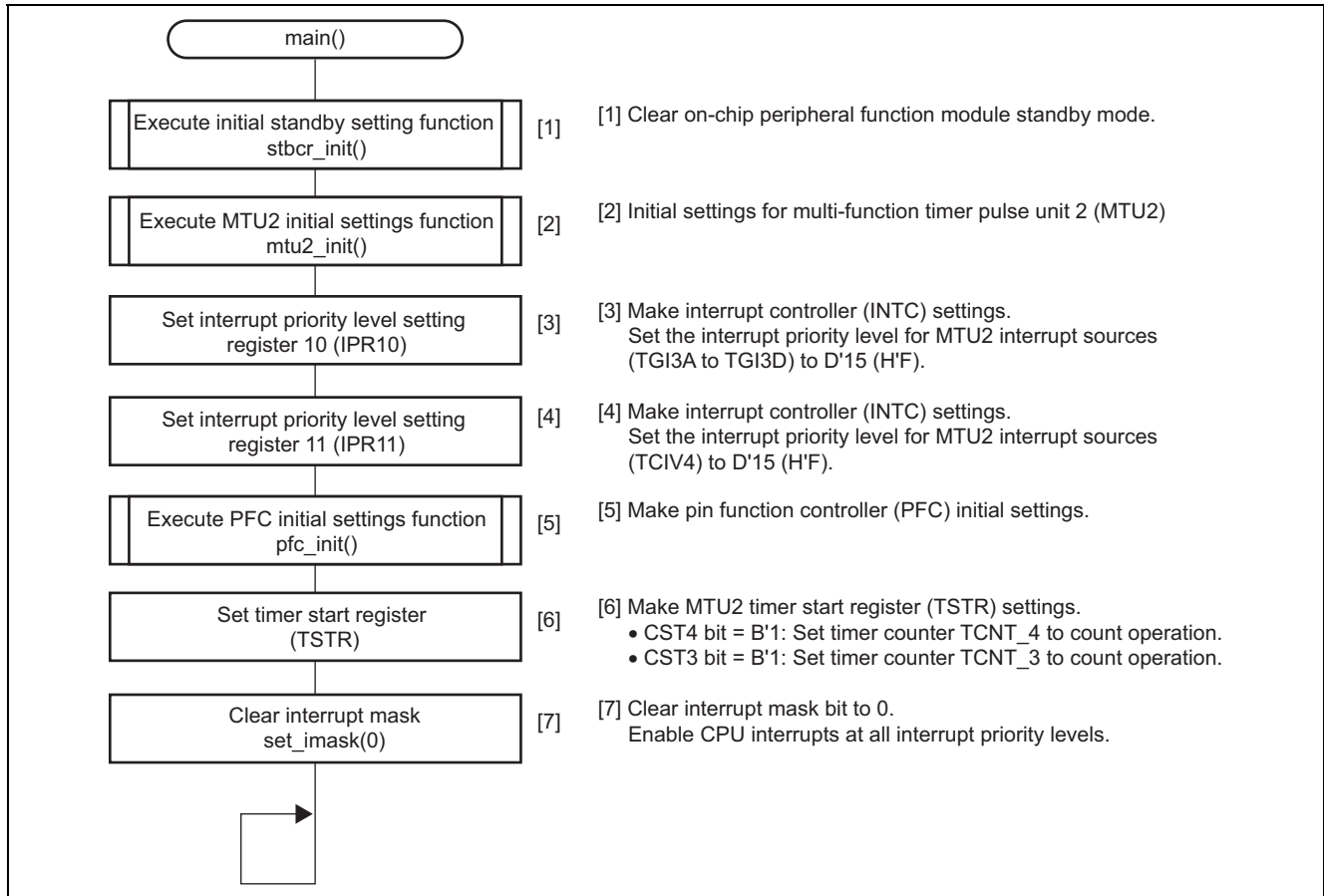

**Figure 11 Processing by Function main**

### 2.4.2 Initialization for Standby

Figure 12 shows the flow of processing for standby processing.

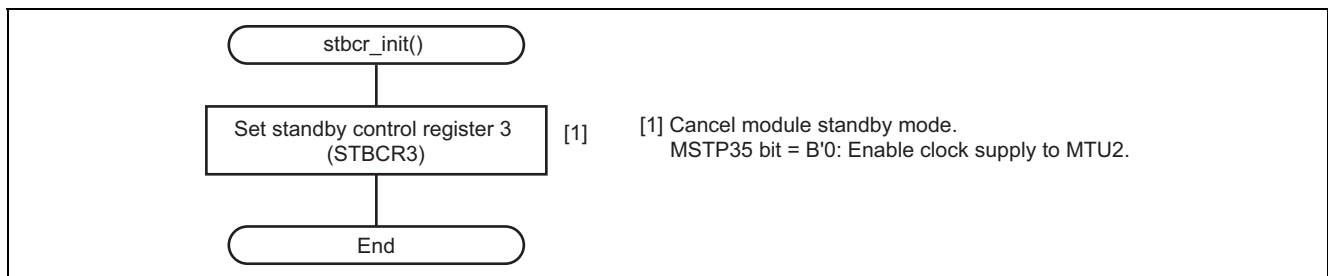

**Figure 12 Initialization for Standby**

### 2.4.3 Initialization of Multi-Function Timer Pulse Unit 2 (MTU2)

Figure 12 shows the processing sequence of the function that makes initial settings for multi-function timer pulse unit 2 (MTU2). Channels 3 and 4 of are set to complementary PWM mode 3.

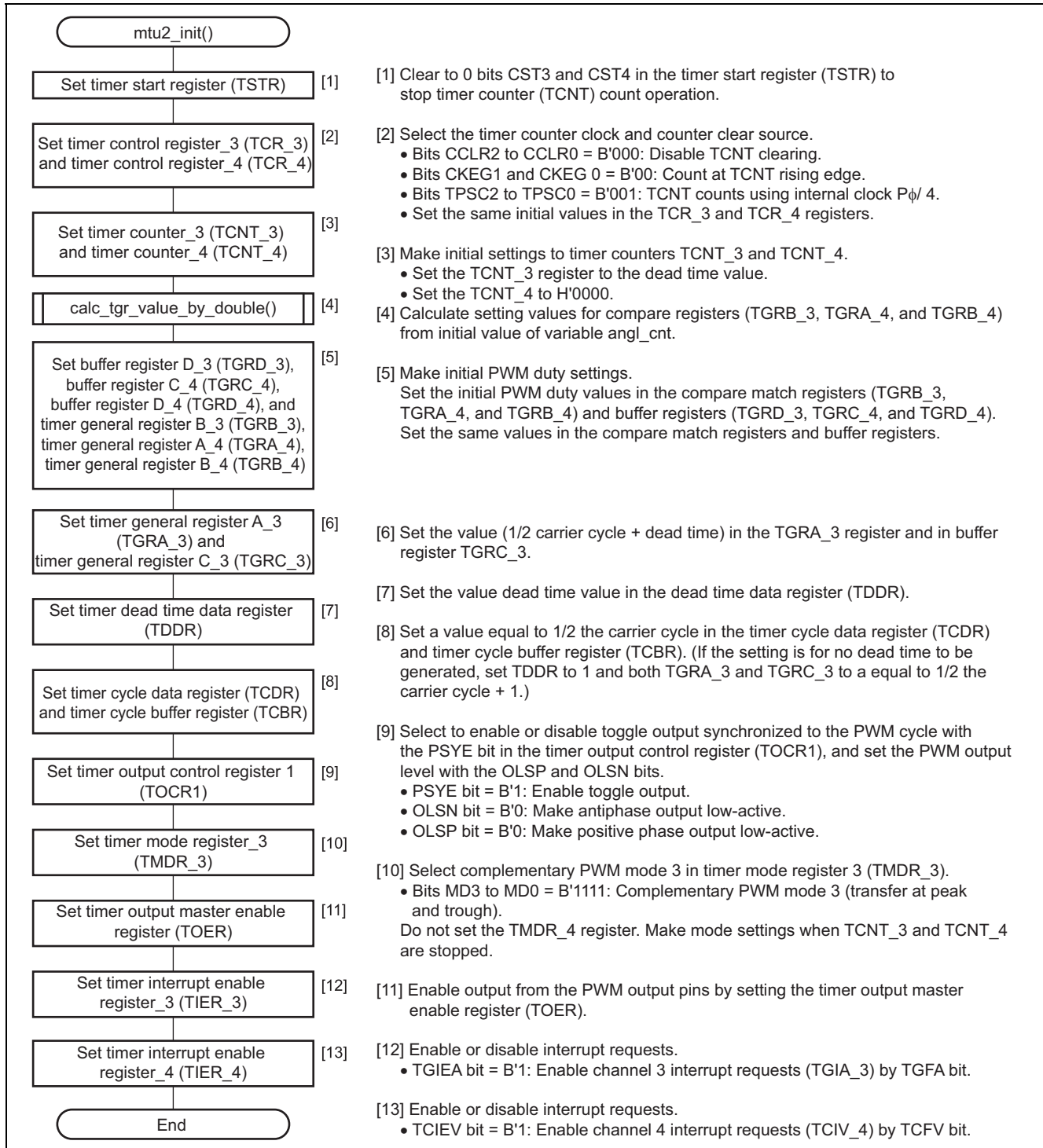
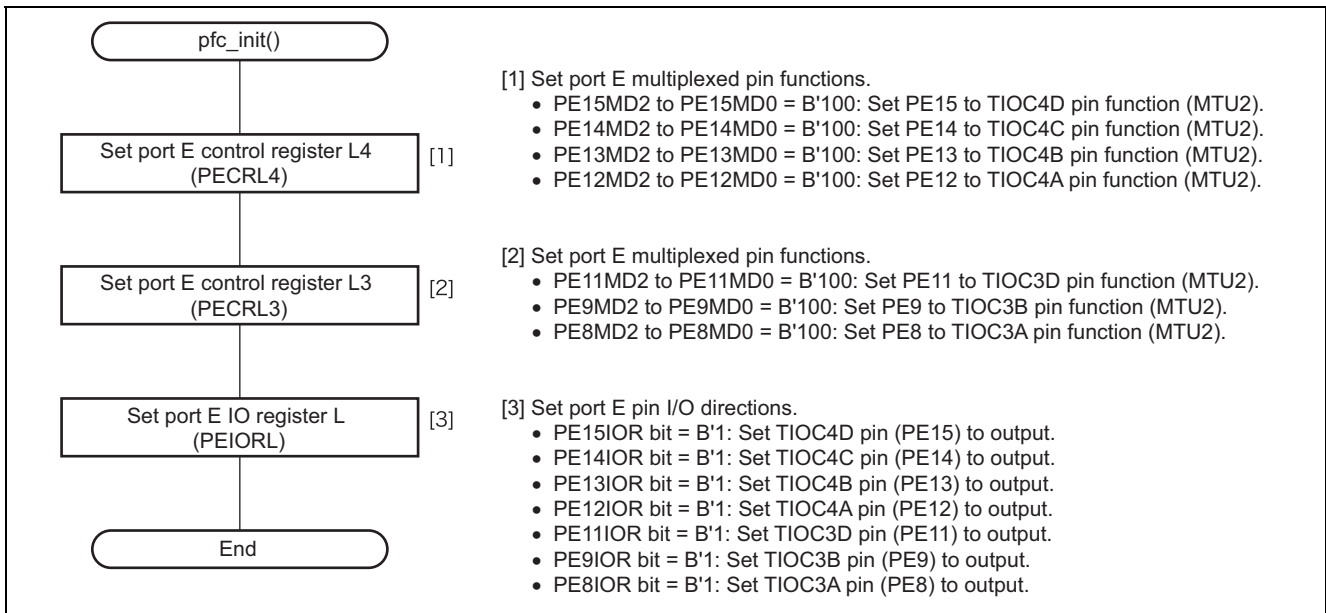

Figure 13 Initialization of MTU2

**2.4.4 Initialization of Pin Function Controller (PFC)**

Figure 14 shows the flow for initialization of the PFC.



**Figure 14 Initialization of Pin Function Controller (PFC)**

2.4.5 Handling of the Compare Match Interrupt

Figures 15 (a) and (b) show the flow for handling the compare match interrupt (TGRA\_3) from MTU2. Figure 15 (a) is a flowchart of the program code that uses the FPU, and figure 15 (b) is a flowchart of the program code that does not use the FPU.

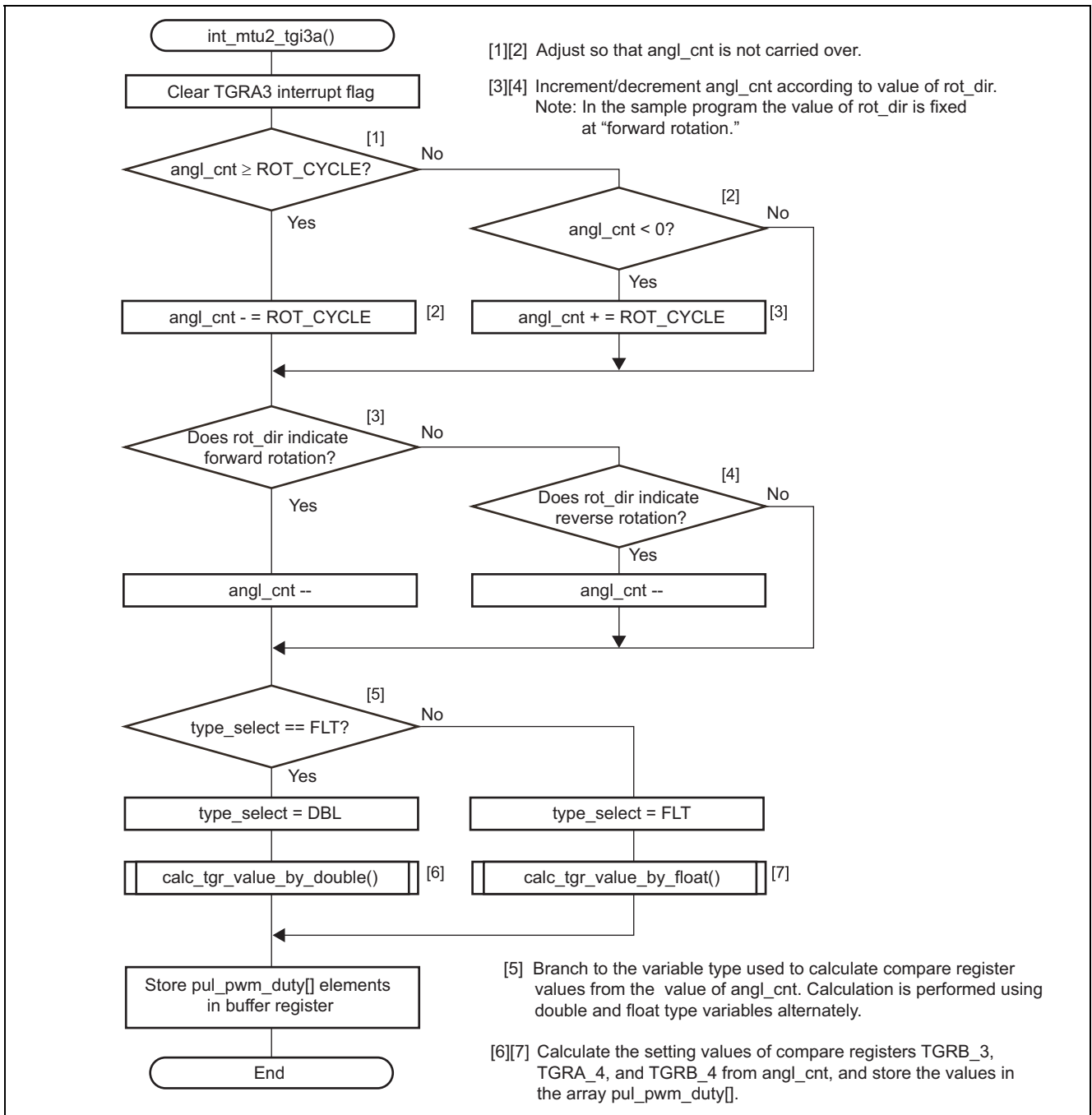

Figure 15 (a) MTU2 Compare-Match Interrupt (TGRA\_3) Handler (Using FPU)

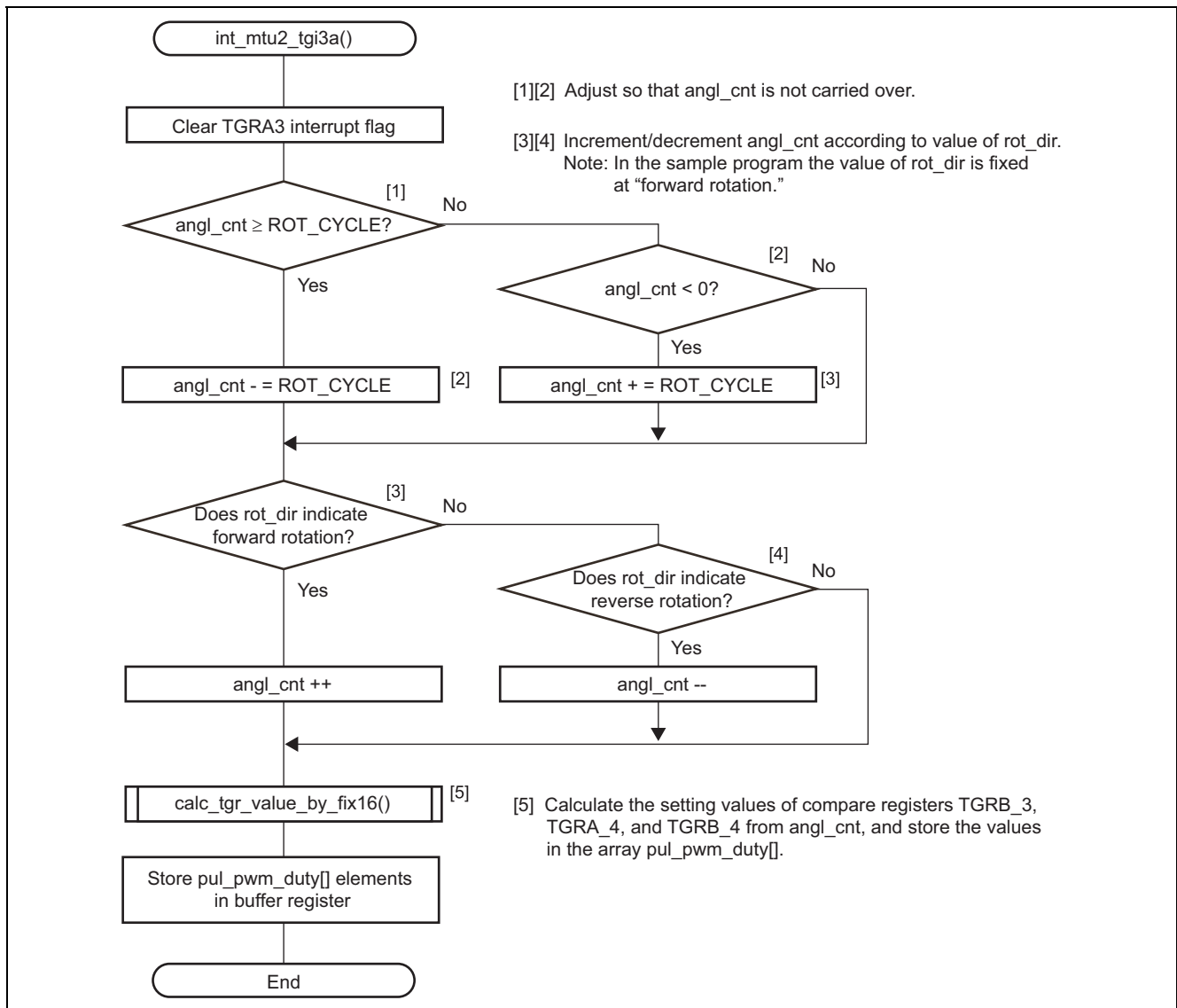

Figure 15 (b) MTU2 Compare-Match Interrupt (TGRA\_3) Handler (Not Using FPU)

### 2.4.6 Overflow Interrupt Handler

Figure 16 shows the processing sequence of the MTU2 overflow interrupt (TCNT\_4) handler.

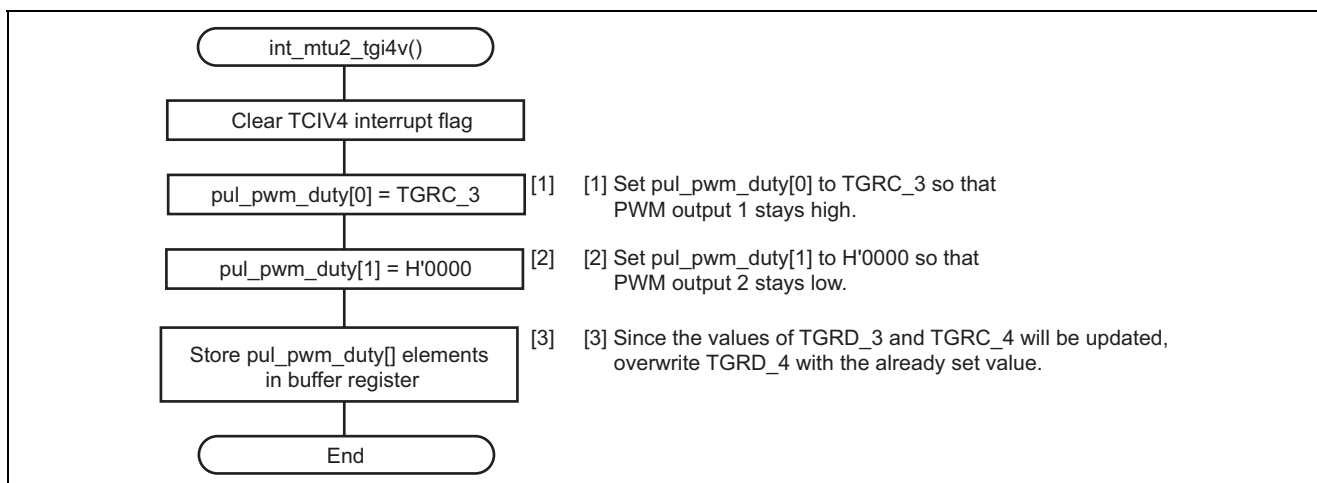

Figure 16 MTU2 Overflow Interrupt (TCNT\_4) Handler

### 2.4.7 Calculation of Compare Register Values

Figure 17 shows the processing sequence for calculating compare register values using double type variables and the math.h calculation library. The processing sequences using float type variables and the mathf.h calculation library and using FIX16 and the fixmath.h fixed-point library are analogous.

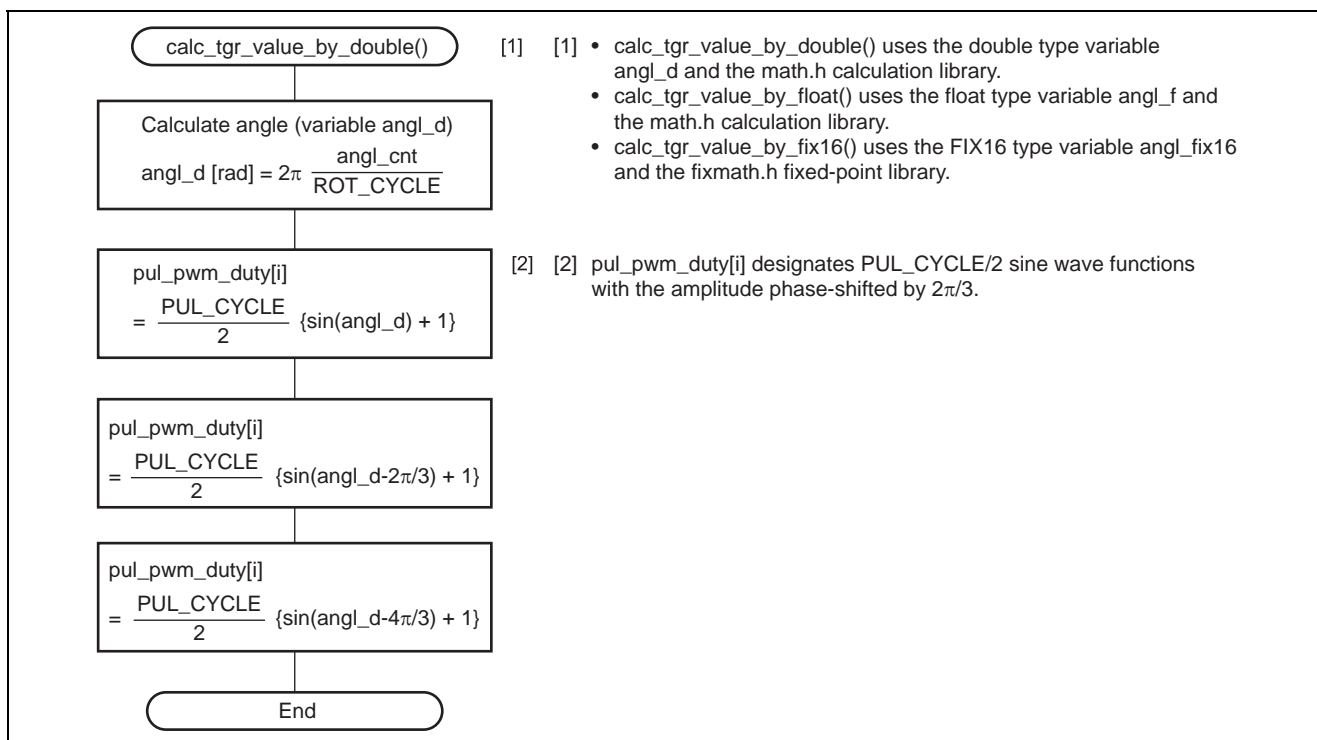

Figure 17 Calculation of Compare Register Values



## 2.5 Settings of Registers in the Sample Program

The following describes the settings of registers used in the sample program.

### 2.5.1 Clock Pulse Generator (CPG)

Table 6 gives a list of settings for registers of the clock pulse generator (CPG).

**Table 6 Clock Pulse Generator (CPG)**

Register Name	Address	Setting	Description
Frequency control register (FRQCR)	H'FFFE0010	H'0303	Specifies the clock output settings and operating frequency multiplication ratios. <ul style="list-style-type: none"> <li>• STC2 to STC0 = B'011: Bus clock (<math>B\phi</math>) <math>\times</math> 1/4</li> <li>• IFC2 to IFC0 = B'000: Internal clock (<math>I\phi</math>) <math>\times</math> 1</li> <li>• PFC2 to PFC0 = B'011: Peripheral clock (<math>P\phi</math>) <math>\times</math> 1/4</li> </ul>

### 2.5.2 Power-Down Mode

Table 7 shows the register settings for power down mode.

**Table 7 Power-Down Mode**

Register Name	Address	Setting	Description
Standby control register 3 (STBCR3)	H'FFFE0408	H'5E	Specifies the operation settings for individual modules. <ul style="list-style-type: none"> <li>• HIZ= B'0: Maintain pin state in software standby mode.</li> <li>• MSTP36 = B'1: Stop clock supply to MTU2S.</li> <li>• MSTP35 = B'0: Operate MTU2.</li> <li>• MSTP34 = B'1: Reserved bit</li> <li>• MSTP33 = B'1: Stop clock supply to IIC3.</li> <li>• MSTP32 = B'1: Stop clock supply to ADC.</li> <li>• MSTP31 = B'1: Reserved bit</li> <li>• MSTP30 = B'0: Operate flash memory.</li> </ul>

**2.5.3 Multi-Function Timer Pulse Unit 2 (MTU2)**

Table 8 gives a list of settings for registers of multi-function timer pulse unit 2 (MTU2).

**Table 8 Multi-Function Timer Pulse Unit 2 (MTU2)**

Register Name	Address	Value	Description
Timer control register 3 (TCR_3)	H'FFFE4200	H'01	TCNT control settings CCLR2 to CCLR0 = B'000: Disable clearing of TCNT. CKEG1 and CKEG0 = B'00: Count at rising edge. TPSC2 to TPSC0 = B'001: TCNT counts using internal clock $P\phi / 4$ .
Timer control register 4 (TCR_4)	H'FFFE4201	H'01	TCNT control settings CCLR2 to CCLR0 = B'000: Disable clearing of TCNT. CKEG1 and CKEG0 = B'00: Count at rising edge. TPSC2 to TPSC0 = B'001: TCNT counts using internal clock $P\phi / 4$ .
Timer counter 3 (TCNT_3)	H'FFFE4210	D'40	16 bit counter In complementary PWM mode, set the initial value to match the setting value of the timer dead time data register (TDDR).
Timer counter 4 (TCNT_4)	H'FFFE4212	H'0000	16 bit counter Set the initial value to H'0000.
Timer general register A_3 (TGRA_3)	H'FFFE4218	D'2040	In complementary PWM mode, set the TCNT_3 upper limit to a value of (1/2 carrier cycle + dead time).
Timer general register C_3 (TGRC_3)	H'FFFE4224		In complementary PWM mode, set the initial value of the TGRA_3 buffer register to match the setting value of the TGRA_3 register.
Timer general register B_3 (TGRB_3)	H'FFFE421A	D'0 to D'2550	In complementary PWM mode, set the PWM output 1 compare register PWM duty.
Timer general register D_3 (TGRD_3)	H'FFFE4226		In complementary PWM mode, set the initial value of the TGRB_3 buffer register to match the setting value of the TGRB_3 register. New PWM duty values are set in this register.
Timer general register A_4 (TGRA_4)	H'FFFE421C	D'0 to D'2550	In complementary PWM mode, set the PWM output 2 compare register PWM duty.
Timer general register C_4 (TGRC_4)	H'FFFE4228		In complementary PWM mode, set the initial value of the TGRA_4 buffer register to match the setting value of the TGRA_4 register. New PWM duty values are set in this register.
Timer general register B_4 (TGRB_4)	H'FFFE421E	D'0 to D'2550	In complementary PWM mode, set the PWM output 3 compare register PWM duty.
Timer general register D_4 (TGRD_4)	H'FFFE422A		In complementary PWM mode, set the initial value of the TGRB_4 buffer register to match the setting value of the TGRB_4 register. New PWM duty values are set in this register.
Timer dead time data register (TDDR)	H'FFFE4216	D'40	This 16-bit register is only used in complementary PWM mode. Set the offset value (dead time value) for TCNT_4 and TCNT_3.

## SH7216 Group MTU2 Asymmetric Complementary PWM Output (Complementary PWM Mode)

Register Name	Address	Value	Description
Timer cycle data register (TCDR)	H'FFFE4214	D'2000	This register is only used in complementary PWM mode. Set the TCNT_4 upper limit value (1/2 the carrier cycle).
Timer cycle buffer register (TCBR)	H'FFFE4222		This register is only used in complementary PWM mode. It functions as the buffer register for the TCDR register. Set the same value as that for the TCDR register.
Timer output control register 1 (TOCR1)	H'FFFE420E	H'40	Complementary PWM mode output operation settings <ul style="list-style-type: none"><li>• PSYE = B'1: Enable toggle output synchronized with the PWM cycle.</li><li>• TOCL = B'0: Enable writing to the TOCS, OLSN, and OLSP bits.</li><li>• TOCS = B'0: Enable TOCR1 setting.</li><li>• OLSN = B'0: In complementary PWM mode, select the antiphase output level: Initial output = high, active level = low.</li><li>• OLSP = B'0: In complementary PWM mode, select the positive phase output level: Initial output = high, active level = low.</li></ul>
Timer mode register 3 (TMDR_3)	H'FFFE4202	H'3F	Sets the operation mode (channel 3). <ul style="list-style-type: none"><li>• BFB = B'1: Set TGRB and TGRD to buffer operation.</li><li>• BFA = B'1: Set TGRA and TGRC to buffer operation.</li><li>• MD3 to MD0 = B'1111: Complementary PWM mode 3 (transfer at peak and trough)</li></ul>
Timer mode register 4 (TMDR_4)	H'FFFE4203	—	Sets the operation mode (channel 4). When channel 3 is set to complementary PWM mode, the settings for channel 4 are ignored and the settings for channel 3 are followed automatically. There is no need to make setting to this register. Leave the initial values unchanged.
Timer output master enable register (TOER)	H'FFFE420A	H'FF	Specifies the output settings for the MTU2 output pins. <ul style="list-style-type: none"><li>• OE4D = B'1: Enable MTU2 output on TIOC4D pin.</li><li>• OE4C = B'1: Enable MTU2 output on TIOC4C pin.</li><li>• OE3D = B'1: Enable MTU2 output on TIOC3D pin.</li><li>• OE4B = B'1: Enable MTU2 output on TIOC4B pin.</li><li>• OE4A = B'1: Enable MTU2 output on TIOC4A pin.</li><li>• OE3B = B'1: Enable MTU2 output on TIOC3B pin.</li></ul>
Timer interrupt enable register 3 (TIER_3)	H'FFFE4208	H'01	Enables or disables interrupt requests. <ul style="list-style-type: none"><li>• TGIEA= B'1: Enable interrupt requests (TGIA) by TGFA bit.</li></ul>
Timer interrupt enable register 4 (TIER_4)	H'FFFE4209	H'10	Enables or disables interrupt requests. <ul style="list-style-type: none"><li>• TGIEA= B'1: Enable interrupt requests (TCIV) by TCFV bit.</li></ul>
Timer start register (TSTR)	H'FFFE4280	H'C0	Starts or stops TCNT operation for channels 0 to 4. <ul style="list-style-type: none"><li>• CST4 = B'1: Start TCNT_4 count operation.</li><li>• CST3 = B'1: Start TCNT_3 count operation.</li></ul> Stop count operation by TCNT_2, TCNT_1, and TCNT_0. Make counter operation bit settings for TCNT_4 and TCNT_3 at the same time.

**2.5.4      Interrupt Controller (INTC)**

Table 9 gives a list of settings for registers of the interrupt controller (INTC).

**Table 9    Interrupt Controller (INTC)**

<b>Register Name</b>	<b>Address</b>	<b>Setting</b>	<b>Description</b>
Interrupt priority level setting register 10 (IPR10)	H'FFFE0C08	H'00F0	<p>Sets interrupt priority levels (level 0 to 15).</p> <ul style="list-style-type: none"> <li>• Bits 15 to 12 = B'0000: MTU2 (TGIA_2 and TGIB_2) interrupt level = 0</li> <li>• Bits 11 to 8 = B'0000: MTU2 (TCIV_2 and TCIU_2) interrupt level = 0</li> <li>• Bits 7 to 4 = B'1111: MTU2 (TGIA_3 to TGID_3) interrupt level = 15</li> <li>• Bits 3 to 0 = B'0000: MTU2 (TCIV_3) interrupt level = 0</li> </ul> <p>The TGIA_3 interrupt is used by the reference program.</p>
Interrupt priority level setting register 11 (IPR11)	H'FFFE0C0A	H'0F00	<p>Sets interrupt priority levels (level 0 to 15).</p> <ul style="list-style-type: none"> <li>• Bits 15 to 12 = B'0000: MTU2 (TGIA_4 to TGID_4) interrupt level = 0</li> <li>• Bits 11 to 8 = B'1111: MTU2 (TCIV_4) interrupt level = 15</li> <li>• Bits 7 to 4 = B'0000: MTU2 (TGIU_5, TGIV_5, TGIW_5) interrupt level = 0</li> <li>• Bits 3 to 0 = B'0000: POE2 (OEI1, OEI2) interrupt level = 0</li> </ul> <p>The TCIV_4 interrupt is used by the reference program.</p>

**2.5.5 Pin Function Controller (PFC)**

Table 10 gives a list of settings for registers of the pin function controller (PFC).

**Table 10 Pin Function Controller (PFC)**

Register Name	Address	Setting	Description
Port E control register L4 (PECRL4)	H'FFFE3A10	H'4444	Sets port E multiplexed pin functions. <ul style="list-style-type: none"> <li>• PE15MD2 to PE15MD0 = E'100: Set PE15 to TIOC4D I/O (MTU2).</li> <li>• PE14MD2 to PE14MD0 = E'100: Set PE14 to TIOC4C I/O (MTU2).</li> <li>• PE13MD2 to PE13MD0 = E'100: Set PE13 to TIOC4B I/O (MTU2).</li> <li>• PE12MD2 to PE12MD0 = E'100: Set PE12 to TIOC4A I/O (MTU2).</li> </ul>
Port E control register L3 (PECRL3)	H'FFFE3A12	H'4044	Sets port E multiplexed pin functions. <ul style="list-style-type: none"> <li>• PE11MD2 to PE11MD0 = E'100: Set PE11 to TIOC3D I/O (MTU2).</li> <li>• PE10MD2 to PE10MD0 = E'100: Set PE10 to TIOC3B I/O (MTU2).</li> <li>• PE9MD2 to PE9MD0 = E'100: Set PE9 to TIOC3B I/O (MTU2).</li> <li>• PE8MD2 to PE8MD0 = E'000: Set PE8 to PE8 I/O (port).</li> </ul>
Port B I/O register H (PBIORH)	H'FFFE3884	H'000E	Sets port B pin I/O directions. <ul style="list-style-type: none"> <li>• PB19IOR = B'1: Set PB19 (TIOC3D) as an output pin.</li> <li>• PB18IOR = B'1: Set PB18 (TIOC3B) as an output pin.</li> <li>• PB17IOR = B'1: Set PB17 (TIOC3A) as an output pin.</li> <li>• PB16IOR = B'0: Set PB16 (port) as an input pin.</li> </ul> Set all the others to B'0: All input pins.
Port B I/O register L (PBIORL)	H'FFFE3886	H'00F0	Sets port B pin I/O directions. <ul style="list-style-type: none"> <li>• PB7IOR = B'1: Set PB7 (TIOC4D) as an output pin.</li> <li>• PB6IOR = B'1: Set PB6 (TIOC4C) as an output pin.</li> <li>• PB5IOR = B'1: Set PB5 (TIOC4B) as an output pin.</li> <li>• PB4IOR = B'1: Set PB4 (TIOC4A) as an output pin.</li> </ul> Set all the others to B'0: All input pins.

### **3. Documents for Reference**

- Hardware Manual  
SH7216 Group Hardware Manual [R01UH0230EJ0300]  
(The latest version can be downloaded from the Renesas Electronics Web site.)
- Software Manual  
SH-2A/SH2A-FPU Software Manual [REJ09B0051]  
(The latest version can be downloaded from the Renesas Electronics Web site.)

## **Website and Support**

Renesas Electronics Website

<http://www.renesas.com/>

Inquiries

<http://www.renesas.com/inquiry>

All trademarks and registered trademarks are the property of their respective owners.

## Revision Record

Rev.	Date	Description	
		Page	Summary
1.00	Jun.03.11	—	First edition issued



## General Precautions in the Handling of MPU/MCU Products

The following usage notes are applicable to all MPU/MCU products from Renesas. For detailed usage notes on the products covered by this manual, refer to the relevant sections of the manual. If the descriptions under General Precautions in the Handling of MPU/MCU Products and in the body of the manual differ from each other, the description in the body of the manual takes precedence.

### 1. Handling of Unused Pins

Handle unused pins in accord with the directions given under Handling of Unused Pins in the manual.

- The input pins of CMOS products are generally in the high-impedance state. In operation with an unused pin in the open-circuit state, extra electromagnetic noise is induced in the vicinity of LSI, an associated shoot-through current flows internally, and malfunctions occur due to the false recognition of the pin state as an input signal become possible. Unused pins should be handled as described under Handling of Unused Pins in the manual.

### 2. Processing at Power-on

The state of the product is undefined at the moment when power is supplied.

- The states of internal circuits in the LSI are indeterminate and the states of register settings and pins are undefined at the moment when power is supplied.

In a finished product where the reset signal is applied to the external reset pin, the states of pins are not guaranteed from the moment when power is supplied until the reset process is completed.

In a similar way, the states of pins in a product that is reset by an on-chip power-on reset function are not guaranteed from the moment when power is supplied until the power reaches the level at which resetting has been specified.

### 3. Prohibition of Access to Reserved Addresses

Access to reserved addresses is prohibited.

- The reserved addresses are provided for the possible future expansion of functions. Do not access these addresses; the correct operation of LSI is not guaranteed if they are accessed.

### 4. Clock Signals

After applying a reset, only release the reset line after the operating clock signal has become stable.

When switching the clock signal during program execution, wait until the target clock signal has stabilized.

- When the clock signal is generated with an external resonator (or from an external oscillator) during a reset, ensure that the reset line is only released after full stabilization of the clock signal. Moreover, when switching to a clock signal produced with an external resonator (or by an external oscillator) while program execution is in progress, wait until the target clock signal is stable.

### 5. Differences between Products

Before changing from one product to another, i.e. to one with a different type number, confirm that the change will not lead to problems.

- The characteristics of MPU/MCU in the same group but having different type numbers may differ because of the differences in internal memory capacity and layout pattern. When changing to products of different type numbers, implement a system-evaluation test for each of the products.

## Notice

1. All information included in this document is current as of the date this document is issued. Such information, however, is subject to change without any prior notice. Before purchasing or using any Renesas Electronics products listed herein, please confirm the latest product information with a Renesas Electronics sales office. Also, please pay regular and careful attention to additional and different information to be disclosed by Renesas Electronics such as that disclosed through our website.
  2. Renesas Electronics does not assume any liability for infringement of patents, copyrights, or other intellectual property rights of third parties by or arising from the use of Renesas Electronics products or technical information described in this document. No license, express, implied or otherwise, is granted hereby under any patents, copyrights or other intellectual property rights of Renesas Electronics or others.
  3. You should not alter, modify, copy, or otherwise misappropriate any Renesas Electronics product, whether in whole or in part.
  4. Descriptions of circuits, software and other related information in this document are provided only to illustrate the operation of semiconductor products and application examples. You are fully responsible for the incorporation of these circuits, software, and information in the design of your equipment. Renesas Electronics assumes no responsibility for any losses incurred by you or third parties arising from the use of these circuits, software, or information.
  5. When exporting the products or technology described in this document, you should comply with the applicable export control laws and regulations and follow the procedures required by such laws and regulations. You should not use Renesas Electronics products or the technology described in this document for any purpose relating to military applications or use by the military, including but not limited to the development of weapons of mass destruction. Renesas Electronics products and technology may not be used for or incorporated into any products or systems whose manufacture, use, or sale is prohibited under any applicable domestic or foreign laws or regulations.
  6. Renesas Electronics has used reasonable care in preparing the information included in this document, but Renesas Electronics does not warrant that such information is error free. Renesas Electronics assumes no liability whatsoever for any damages incurred by you resulting from errors in or omissions from the information included herein.
  7. Renesas Electronics products are classified according to the following three quality grades: "Standard", "High Quality", and "Specific". The recommended applications for each Renesas Electronics product depends on the product's quality grade, as indicated below. You must check the quality grade of each Renesas Electronics product before using it in a particular application. You may not use any Renesas Electronics product for any application categorized as "Specific" without the prior written consent of Renesas Electronics. Further, you may not use any Renesas Electronics product for any application for which it is not intended without the prior written consent of Renesas Electronics. Renesas Electronics shall not be in any way liable for any damages or losses incurred by you or third parties arising from the use of any Renesas Electronics product for an application categorized as "Specific" or for which the product is not intended where you have failed to obtain the prior written consent of Renesas Electronics. The quality grade of each Renesas Electronics product is "Standard" unless otherwise expressly specified in a Renesas Electronics data sheets or data books, etc.  
"Standard": Computers; office equipment; communications equipment; test and measurement equipment; audio and visual equipment; home electronic appliances; machine tools; personal electronic equipment; and industrial robots.  
"High Quality": Transportation equipment (automobiles, trains, ships, etc.); traffic control systems; anti-disaster systems; anti-crime systems; safety equipment; and medical equipment not specifically designed for life support.  
"Specific": Aircraft; aerospace equipment; submersible repeaters; nuclear reactor control systems; medical equipment or systems for life support (e.g. artificial life support devices or systems), surgical implantations, or healthcare intervention (e.g. excision, etc.), and any other applications or purposes that pose a direct threat to human life.
  8. You should use the Renesas Electronics products described in this document within the range specified by Renesas Electronics, especially with respect to the maximum rating, operating supply voltage range, movement power voltage range, heat radiation characteristics, installation and other product characteristics. Renesas Electronics shall have no liability for malfunctions or damages arising out of the use of Renesas Electronics products beyond such specified ranges.
  9. Although Renesas Electronics endeavors to improve the quality and reliability of its products, semiconductor products have specific characteristics such as the occurrence of failure at a certain rate and malfunctions under certain use conditions. Further, Renesas Electronics products are not subject to radiation resistance design. Please be sure to implement safety measures to guard them against the possibility of physical injury, and injury or damage caused by fire in the event of the failure of a Renesas Electronics product, such as safety design for hardware and software including but not limited to redundancy, fire control and malfunction prevention, appropriate treatment for aging degradation or any other appropriate measures. Because the evaluation of microcomputer software alone is very difficult, please evaluate the safety of the final products or system manufactured by you.
  10. Please contact a Renesas Electronics sales office for details as to environmental matters such as the environmental compatibility of each Renesas Electronics product. Please use Renesas Electronics products in compliance with all applicable laws and regulations that regulate the inclusion or use of controlled substances, including without limitation, the EU RoHS Directive. Renesas Electronics assumes no liability for damages or losses occurring as a result of your noncompliance with applicable laws and regulations.
  11. This document may not be reproduced or duplicated, in any form, in whole or in part, without prior written consent of Renesas Electronics.
  12. Please contact a Renesas Electronics sales office if you have any questions regarding the information contained in this document or Renesas Electronics products, or if you have any other inquiries.
- (Note 1) "Renesas Electronics" as used in this document means Renesas Electronics Corporation and also includes its majority-owned subsidiaries.  
(Note 2) "Renesas Electronics product(s)" means any product developed or manufactured by or for Renesas Electronics.



### SALES OFFICES

Renesas Electronics Corporation

<http://www.renesas.com>

Refer to "<http://www.renesas.com/>" for the latest and detailed information.

#### Renesas Electronics America Inc.

2880 Scott Boulevard Santa Clara, CA 95050-2554, U.S.A.  
Tel: +1-408-588-6000, Fax: +1-408-588-6130

#### Renesas Electronics Canada Limited

1101 Nicholson Road, Newmarket, Ontario L3Y 9C3, Canada  
Tel: +1-905-898-5441, Fax: +1-905-898-3220

#### Renesas Electronics Europe Limited

Dukes Meadow, Millboard Road, Bourne End, Buckinghamshire, SL8 5FH, U.K  
Tel: +44-1628-585-100, Fax: +44-1628-585-900

#### Renesas Electronics Europe GmbH

Arcadiastrasse 10, 40472 Düsseldorf, Germany  
Tel: +49-211-65030, Fax: +49-211-6503-1327

#### Renesas Electronics (China) Co., Ltd.

7th Floor, Quantum Plaza, No.27 ZhichunLu Haidian District, Beijing 100083, P.R.China  
Tel: +86-10-8235-1155, Fax: +86-10-8235-7679

#### Renesas Electronics (Shanghai) Co., Ltd.

Unit 204, 205, AZIA Center, No.1233 Lujiazui Ring Rd., Pudong District, Shanghai 200120, China  
Tel: +86-21-5877-1818, Fax: +86-21-6887-7858 / -7898

#### Renesas Electronics Hong Kong Limited

Unit 1601-1613, 16/F., Tower 2, Grand Century Place, 193 Prince Edward Road West, Mongkok, Kowloon, Hong Kong  
Tel: +852-2886-9318, Fax: +852 2886-9022/9044

#### Renesas Electronics Taiwan Co., Ltd.

13F, No. 363, Fu Shing North Road, Taipei, Taiwan  
Tel: +886-2-8175-9600, Fax: +886 2-8175-9670

#### Renesas Electronics Singapore Pte. Ltd.

1 HarbourFront Avenue, #06-10, Keppel Bay Tower, Singapore 098632  
Tel: +65-6213-0200, Fax: +65-6278-8001

#### Renesas Electronics Malaysia Sdn.Bhd.

Unit 906, Block B, Menara Amcorp, Amcorp Trade Centre, No. 18, Jln Persiaran Barat, 46050 Petaling Jaya, Selangor Darul Ehsan, Malaysia  
Tel: +60-3-7955-9390, Fax: +60-3-7955-9510

#### Renesas Electronics Korea Co., Ltd.

11F., Samik Lavied' or Bldg., 720-2 Yeoksam-Dong, Kangnam-Ku, Seoul 135-080, Korea  
Tel: +82-2-558-3737, Fax: +82-2-558-5141