

## RZ/A2M Group

### Color and Image Quality Correction Sample Program

---

#### Introduction

This document describes a sample program for color and image quality correction using the RZ/A2M.

#### Target Device

RZ/A2M

#### Contents

1. Overview .....	2
1.1 Processing Overview.....	3
1.2 DRP Library .....	4
1.3 Operation Confirmation Environment.....	4
2. Operation Confirmation Conditions .....	5
3. Related Application Notes.....	6
4. File Structure .....	7
5. Sample Program.....	9
5.1 Automatic Exposure Correction (AE) .....	9
5.2 Demosaicing.....	11
5.3 Color Correction .....	11
5.4 Noise Reduction .....	12
5.5 Sharpening .....	12
5.6 3D Noise Reduction.....	12
5.7 Memory footprint.....	13
5.7.1 On-chip RAM usage .....	13
5.7.2 ROM usage .....	13
6. Reference Documents .....	14
Revision History .....	15

## 1. Overview

This application note explains a sample program which converting images in Bayer format to YCbCr422 format using the DRP (Dynamic Reconfigurable Processor). By using the Simple ISP library of DRP, it is possible to perform color correction, noise reduction, and obtain images with high color reproducibility.

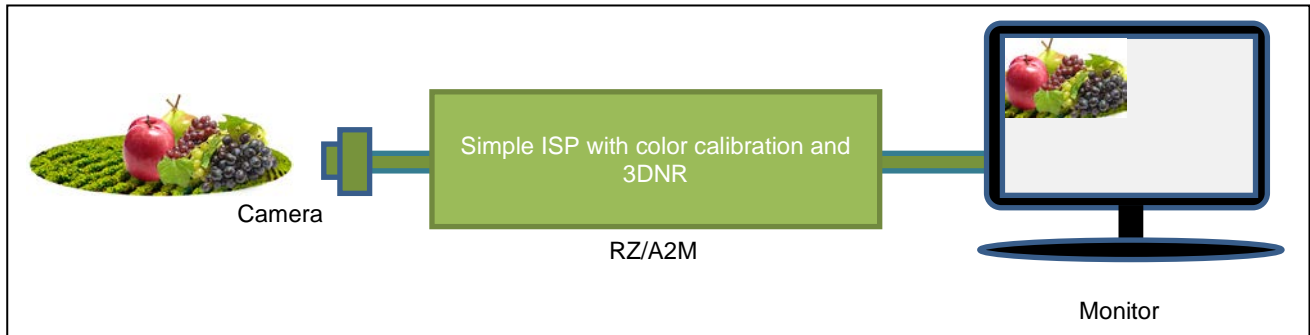

**Figure 1.1 System Overview of Sample Program**

**Table 1.1 Camera Input Specifications**

Input image format	Bayer format (8 bpp)
Image capture size	640 × 480
Capture frame rate	60 fps

**Table 1.2 Display Output Specifications**

Output image format	YCbCr422 format (16 bpp)
Output image display size	640 × 480
Image display frame rate	30 fps

### 1.1 Processing Overview

This sample program converts the image captured in Bayer format to a color image using Simple ISP, then performs color correction and noise reduction. For details of Simple ISP processing, refer to 5, Sample Program.

Figure 1.2 shows a system block diagram of this sample program.

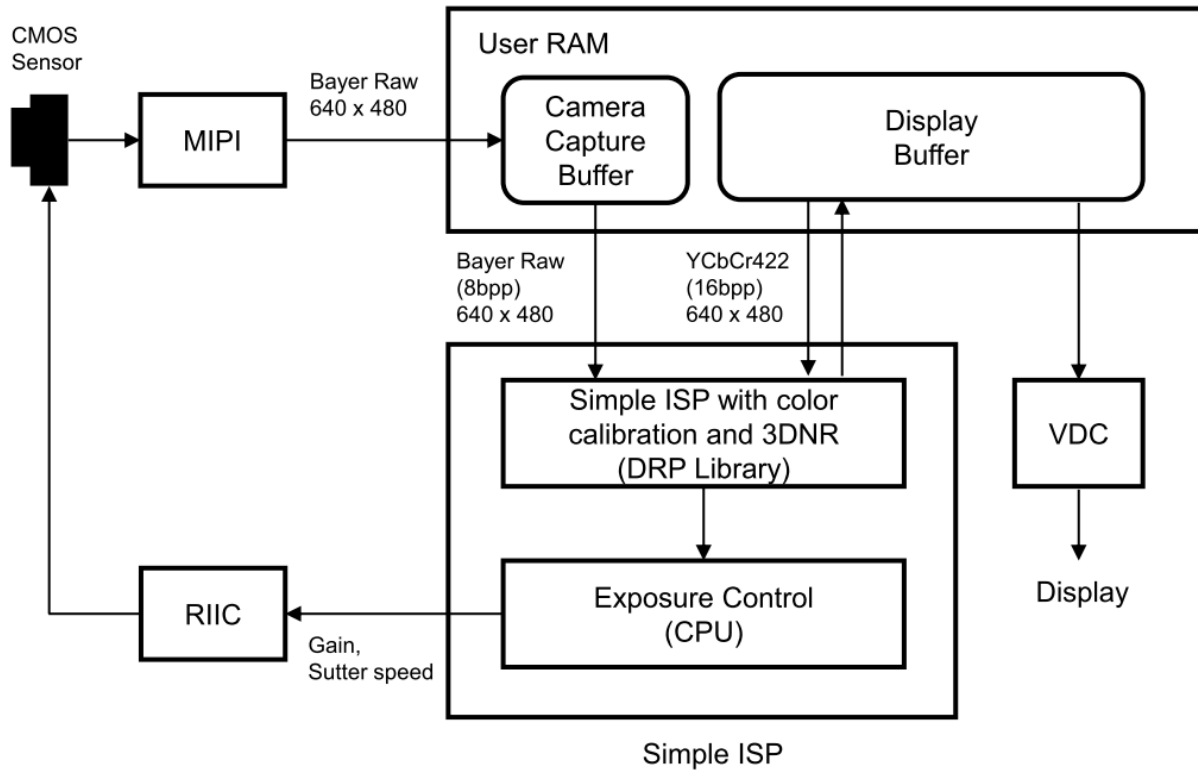

Figure 1.2 System Block Diagram of Color and Image Quality Correction Sample Program

## 1.2 DRP Library

The DRP library enables a variety of functions to be implemented on the DRP incorporated into the RZ/A2M. For details, refer to RZ/A2M Group DRP Library User's Manual (R01US0367).

The sample program uses the library functions listed below.

**Table 1.3 Library Functions Used**

Library Name	Tile Number	Description
Simple ISP with color calibration and 3DNR	6	Bias correction, color component accumulation, demosaicing, gain correction, color matrix correction, YCbCr format convert, noise reduction, sharpening, gamma correction, and 3D noise reduction

## 1.3 Operation Confirmation Environment

Figure 1.3 shows the environment used to confirm operation of the sample program. Refer to the readme.txt for DIP switch and jumper settings.

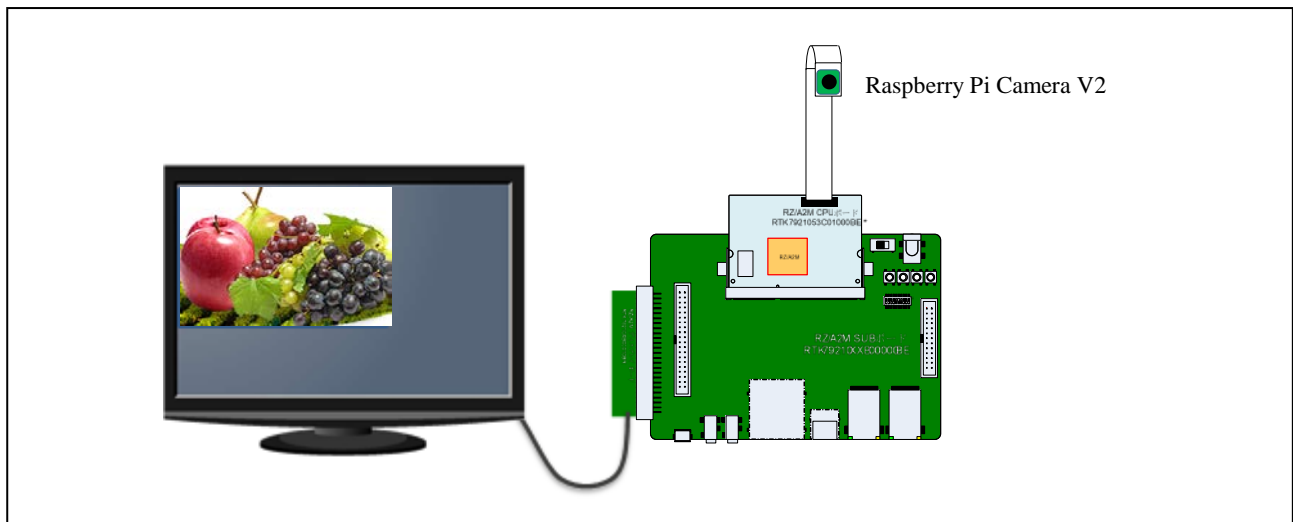

**Figure 1.3 Operation Confirmation Environment**

## 2. Operation Confirmation Conditions

The operation of the sample code has been confirmed under the conditions listed below.

**Table 2.1 Operation Confirmation Conditions**

Item	Description
MCU used	RZ/A2M
Operating frequency*1	CPU clock (I $\phi$ ): 528 MHz Image processing clock (G $\phi$ ): 264 MHz Internal bus clock (B $\phi$ ): 132 MHz Peripheral clock 1 (P1 $\phi$ ): 66 MHz Peripheral clock 0 (P0 $\phi$ ): 33 MHz QSPI0_SPCLK: 66 MHz CKIO: 132 MHz
Operating voltage	Power supply voltage (I/O): 3.3 V Power supply voltage (1.8/3.3 V switchable I/O (PVcc_SPI)): 3.3 V Power supply voltage (Internal): 1.2 V
Integrated development environment	e2 studio (Refer to the release notes for e2 studio version.)
C compiler	GNU Arm Embedded Toolchain 6-2017-q2-update Compiler options (excluding directory path)  Release: -mcpu=cortex-a9 -march=armv7-a -marm -mlittle-endian -mfloat-abi=hard -mfpu=neon -mno-unaligned-access -Os -ffunction-sections -fdata-sections -Wunused -Wuninitialized -Wall -Wextra -Wmissing-declarations -Wconversion -Wpointer-arith -Wpadded -Wshadow -Wlogical-op -Waggregate-return -Wfloat-equal -Wnull-dereference -Wmaybe-uninitialized -Wstack-usage=100 -fabi-version=0  Hardware Debug: -mcpu=cortex-a9 -march=armv7-a -marm -mlittle-endian -mfloat-abi=hard -mfpu=neon -mno-unaligned-access -Og -ffunction-sections -fdata-sections -Wunused -Wuninitialized -Wall -Wextra -Wmissing-declarations -Wconversion -Wpointer-arith -Wpadded -Wshadow -Wlogical-op -Waggregate-return -Wfloat-equal -Wnull-dereference -Wmaybe-uninitialized -g3 -Wstack-usage=100 -fabi-version=0
Operating mode	Boot mode 3 (serial flash boot 3.3 V products)
Board used	RZ/A2M CPU board: RTK7921053C00000BE RZ/A2M SUB board: RTK79210XXB00000BE Display output board for RZ/A2M evaluation board: RTK79210XXB00010BE
Camera used	Raspberry Pi Camera V2
Monitor used	Monitor with Full-WXGA (1,366 × 768) resolution
Device used (functionality used on the board)	Serial flash memory (connected to SPI multi-I/O bus space) Manufacturer: Macronix, model name: MX25L51245GXD

Note: 1. This is the operating frequency used in clock mode 1 (24 MHz clock input on EXTAL pin).

### 3. Related Application Notes

Documents related to this application note are listed below. Refer to them in conjunction with this document.

RZ/A2M Group RZ/A2M Software Core Package (R01AN4775)

(The latest version can be downloaded from the Renesas Electronics website.)

RZ/A2M Group DRP Driver User's Manual (R01US0355)

(The latest version can be downloaded from the Renesas Electronics website.)

RZ/A2M Group DRP Library User's Manual (R01US0367)

(The latest version can be downloaded from the Renesas Electronics website.)

## 4. File Structure

The file structure for this sample program is shown as follow.

rza2m_drp_simpleisp_sample1_freertos_gcc.zip	: Project Top Folder
├─.settings	: Project Setting Files
├─bootloader	: QSPI boot loader
├─doc	: Document of this sample application
│ └─r01an5440ej0101-rza2m-freertos-simpleisp1-gcc.pdf	: RZ/A2M Group Color and Image quality correction Application Note (English)
│ └─r01an5440jj0101-rza2m-freertos-simpleisp1-gcc.pdf	: RZ/A2M Group Color and Image quality correction Application Note (Japanese)
├─generate	: Source files generated / configured by Smart Configurator
│ └─compiler	: Source files depended on the compiler
│ └─configuration	: Header files for project configuration
│ └─drivers	: Basic drivers
│ │ └─r_cache	: Cache driver
│ │ │ └─doc	: Document of Cache driver
│ │ │ └─inc	: Header files for Cache driver
│ │ │ └─src	: Source files for Cache driver
│ │ └─r_cpg	: Clock pulse generator driver (same folder structure as Cache driver)
│ │ └─r_gpio	: GPIO driver (same folder structure as Cache driver)
│ │ └─r_intc	: INTC driver (same folder structure as Cache driver)
│ │ └─r_mmu	: MMU driver (same folder structure as Cache driver)
│ │ └─r_stb	: STB driver (same folder structure as Cache driver)
│ └─os_abstraction	: OS abstraction layer (same folder structure as Cache driver)
│ │ └─doc	: Document of OS abstraction layer
│ │ └─inc	: Header files for OS abstraction layer
│ │ └─src	: Source files for OS abstraction layer
│ └─sc_drivers	: General drivers
│ │ └─r_cbuffer	: Ring buffer (same folder structure as DRP driver)
│ │ └─r_ceu	: CEU driver (same folder structure as DRP driver)
│ │ └─r_drp	: DRP driver (same folder structure as DRP driver)
│ │ │ └─doc	: Documents of DRP driver
│ │ │ │ └─r01us0355ej0102-rza2m-drp-driver-gcc.pdf	: RZ/A2M Group DRP Driver User's Manual (R01US0355) (English)
│ │ │ │ └─r01us0355jj0102-rza2m-drp-driver-gcc.pdf	: RZ/A2M Group DRP Driver User's Manual (R01US0355) (Japanese)
│ │ │ │ └─r01us0367ej0108-rza2m-drp-library.pdf	: RZ/A2M Group DRP Library User's Manual (R01US0367) (English)
│ │ │ │ └─r01us0367jj0108-rza2m-drp-library.pdf	: RZ/A2M Group DRP Library User's Manual (R01US0367) (Japanese)
│ │ │ └─drp_lib	: Source files for DRP library
│ │ │ └─inc	: Header files for DRP driver
│ │ │ └─src	: Source files for DRP driver
│ │ └─r_mipi	: MIPI driver (same folder structure as DRP driver)
│ │ └─r_ostm	: OS timer driver (same folder structure as DRP driver)
│ │ └─r_riic	: I2C driver (same folder structure as DRP driver)
│ │ └─r_mvapi	: Video utility (same folder structure as DRP driver)
│ │ └─r_scifa	: SCIFA driver (same folder structure as DRP driver)
│ │ └─r_vdc	: VDC driver (same folder structure as DRP driver)
└─system	: System files for example, IO registers
└─src	: Source files for application
│ └─application_code	: main.c
│ └─config_files	: Configurations
│ └─FreeRTOS	: FreeRTOSM
│ │ └─include	: FreeRTOSM header files
│ └─renesas	: Software developed by Renesas
│ │ └─application	: application source files developed by Renesas
│ │ │ └─common	: Common processing
│ │ │ │ └─camera	: Storage folder for Raspberry Pi Camera V2 control processing
│ │ │ │ └─perform	: Storage folder for elapsed time measurement processing
│ │ │ │ └─port_setting	: Storage folder for port setting processing
│ │ │ │ └─render	: Storage folder for character and dot rendering processing
│ │ │ └─inc	: Storage folder for header files

The following open-source software is bundled with the sample program.

**Table 4.1 Bundled Open-Source Software**

<b>Name</b>	<b>Description</b>
FreeRTOS	This open-source software is distributed under the MIT License. The MIT License can be viewed here: <a href="https://opensource.org/licenses/mit-license.php">https://opensource.org/licenses/mit-license.php</a> . FreeRTOS is a real-time operating system kernel for embedded devices. The sample program uses Kernel V10.0.0. Refer to the file structure for the location of the FreeRTOS source code.



### 5. Sample Program

This sample program converts a Bayer format image to a YCbCr422 format image by using the Simple ISP function in the DRP library and performs color correction and noise reduction. This chapter describes the Simple ISP processing.

#### 5.1 Automatic Exposure Correction (AE)

This processing corrects the camera's exposure (shutter speed and camera gain) based on the color component accumulated value of the output from Simple ISP. The camera's exposure corrects by the CPU. Figure 5.1, Figure 5.2, and Figure 5.3 are flowcharts of the camera control processing.

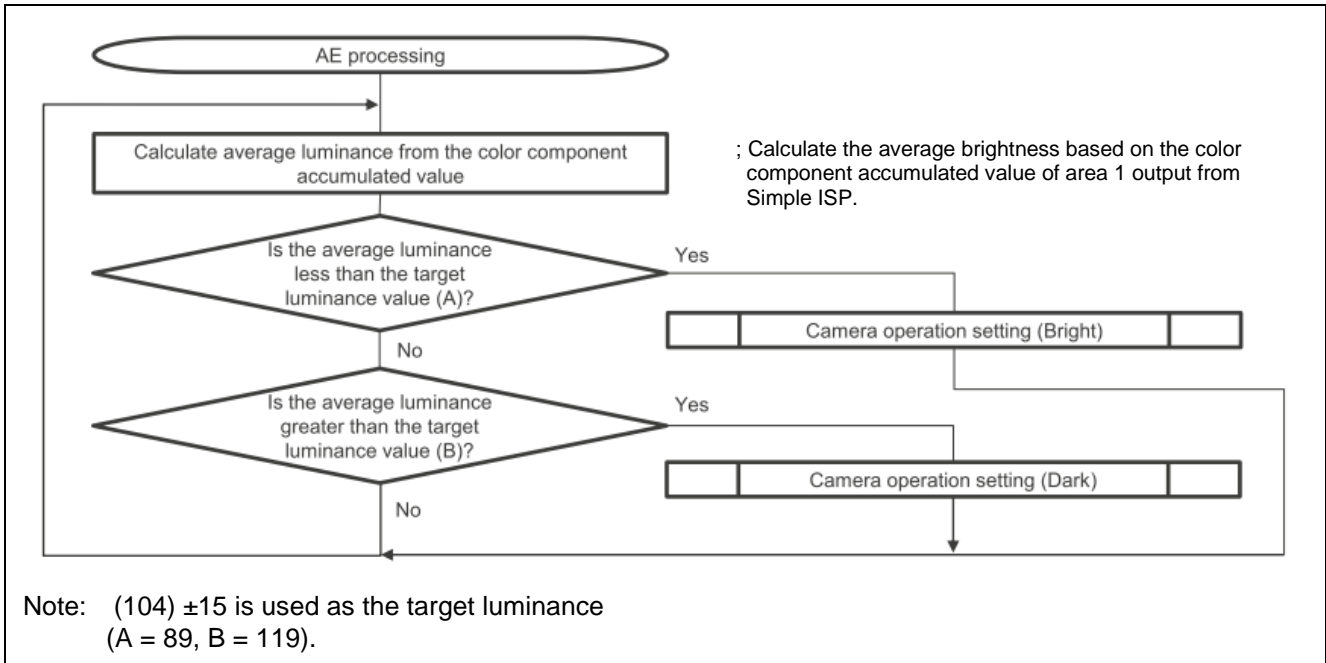

Figure 5.1 AE Processing Flowchart

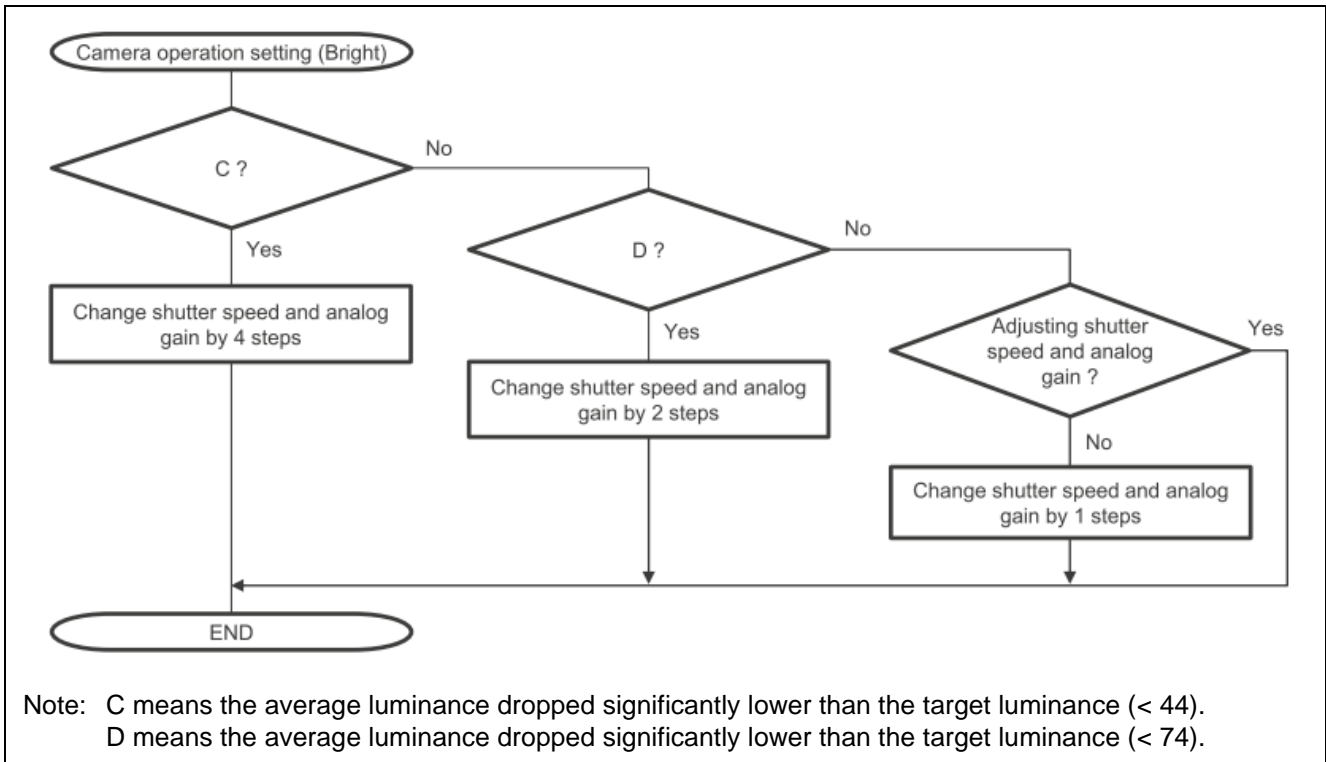

Figure 5.2 Camera Operation Setting (Bright) Flowchart

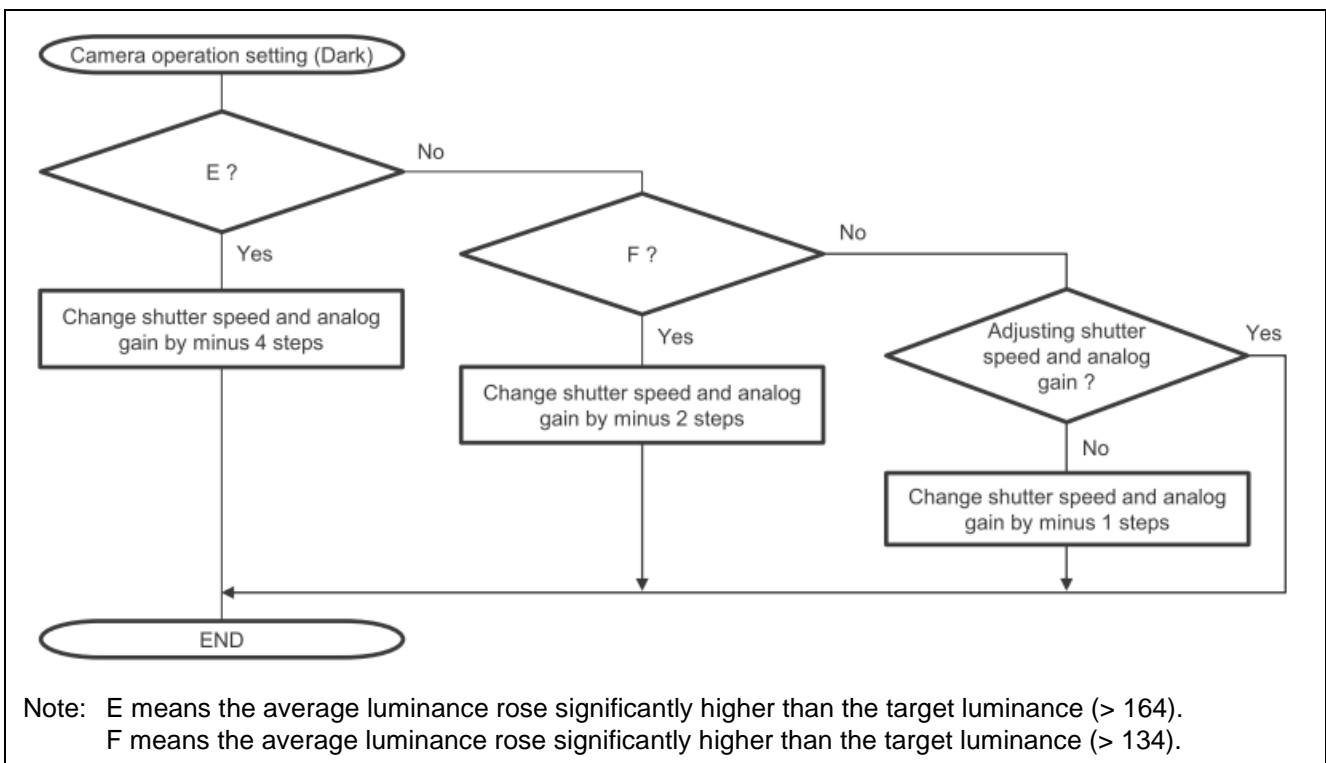

Figure 5.3 Camera Operation Setting (Dark) Flowchart

## 5.2 Demosaicing

Converts the input image from Bayer to RGB format using the Simple ISP.

## 5.3 Color Correction

Performs bias, gain correction, and color matrix correction by 3x3 matrix calculation on the RGB information that has been generated in 5.2, Demosaicing using the Simple ISP processing. Each time pressing the SW3 on the CPU board, the correcting color changes in the order of "OFF (default)", "Bias/Gain correction ON", "Color Matrix correction (Standard)", "Color Matrix correction (Sepia)". Press the SW3 again, 3D noise reduction will be off. The setting values for each bias, gain, and color matrix correction are as follows.

**Table 5.1 List of parameter setting value for Bias/Gain/Color matrix correction**

	Bias	Gain			Color matrix (matrix_cxx)		
	bias_r/ bias_g/ bias_b	gain_r	gain_g	gain_b	c11 c21 c31	c12 c22 c32	c13 c23 c33
OFF	0x00	0x1000	0x1000	0x1000	0x2000 0x0000 0x0000	0x0000 0x2000 0x0000	0x0000 0x0000 0x2000
Bias/Gain correction ON	0xF0	0x2480	0x1800	0x275B	0x2000 0x0000 0x0000	0x0000 0x2000 0x0000	0x0000 0x0000 0x2000
Color Matrix correction ON (Standard)	0xF0	0x2480	0x1800	0x275B	0x25DD 0xFD6A 0x029E	0xFEf0 0x1EF4 0xECF0	0xF79A 0xFD5 0x2C0D
Color Matrix correction ON(Sepia)	0xF0	0x255D	0x1800	0x27BC	0x0946 0x0512 0xFF7D	0x15A7 0x1AF2 0x1BFA	0x04CE 0xFF8F 0xFC78



## 5.4 Noise Reduction

Performs median filtering on the luminance Y converted from RGB format to YCbCr format on RGB information that has been corrected by 5.3 Color Correction.

## 5.5 Sharpening

Sharpening is performed using the unsharp masking algorithm on the luminance Y of the image that has been corrected by 5.4 Noise Reduction.

## 5.6 3D Noise Reduction

Performs 3D noise reduction on the luminance Y and color difference Cb / Cr of the image that has been corrected by 5.5 Sharpening. By pressing the SW4 on the CPU board, 3D noise reduction will be enabled. Press the SW4 again, 3D noise reduction will be disabled. When 3D noise reduction is enabled, the parameter is set to the recommended value.

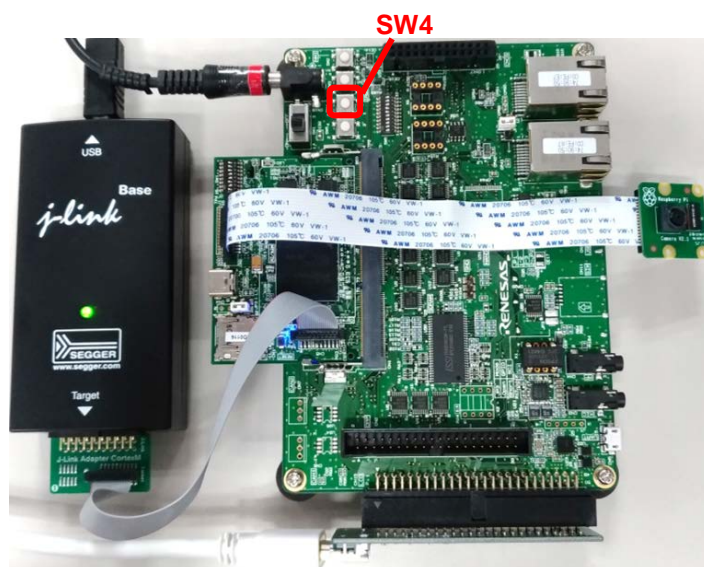

## 5.7 Memory footprint

This sample program uses about 2.8 Mbytes for On-chip RAM, and about 2 Mbyte for ROM. The main uses and rough size of each are shown below.

### 5.7.1 On-chip RAM usage

Use	Rough size (Mbyte)
Camera capture buffer	0.6
Display buffer	1.5
MMU Page Table	0.1
Stack area	0.04
Heap area	0.03
Heap area used by FreeRTOS	0.5

### 5.7.2 ROM usage

Use	Rough size (Mbyte)
Sample program	0.2
DRP configuration data	0.54

## 6. Reference Documents

### User's Manual: Hardware

RZ/A2M Group User's Manual: Hardware

(The latest version can be downloaded from the Renesas Electronics website.)

RTK7921053C00000BE (RZ/A2M CPU board) User's Manual

(The latest version can be downloaded from the Renesas Electronics website.)

RTK79210XXB00000BE (RZ/A2M SUB board) User's Manual

(The latest version can be downloaded from the Renesas Electronics website.)

Arm Architecture Reference Manual ARMv7-A and ARMv7-R edition Issue C

(The latest version can be downloaded from the Arm website.)

Arm Cortex™-A9 Technical Reference Manual Revision: r4p1

(The latest version can be downloaded from the Arm website.)

Arm Generic Interrupt Controller Architecture Specification - Architecture version2.0

(The latest version can be downloaded from the Arm website.)

Arm CoreLink™ Level 2 Cache Controller L2C-310 Technical Reference Manual Revision: r3p3

(The latest version can be downloaded from the Arm website.)

### Technical Update/Technical News

(The latest version can be downloaded from the Renesas Electronics website.)

### User's Manual: Integrated Development

The user's manual of the e2 studio integrated development environment is available for download on the Renesas Electronics website.

**Revision History**

Rev.	Date	Description	
		Page	Summary
1.00	Jun. 30, 2020	-	First edition issued
1.01	Sep. 30, 2020	7	4. File Structure, updated.
		9, 10	Figure 5.1, Figure 5.2, Figure 5.3, updated.

## General Precautions in the Handling of Microprocessing Unit and Microcontroller Unit Products

The following usage notes are applicable to all Microprocessing unit and Microcontroller unit products from Renesas. For detailed usage notes on the products covered by this document, refer to the relevant sections of the document as well as any technical updates that have been issued for the products.

### 1. Precaution against Electrostatic Discharge (ESD)

A strong electrical field, when exposed to a CMOS device, can cause destruction of the gate oxide and ultimately degrade the device operation. Steps must be taken to stop the generation of static electricity as much as possible, and quickly dissipate it when it occurs. Environmental control must be adequate. When it is dry, a humidifier should be used. This is recommended to avoid using insulators that can easily build up static electricity.

Semiconductor devices must be stored and transported in an anti-static container, static shielding bag or conductive material. All test and measurement tools including work benches and floors must be grounded. The operator must also be grounded using a wrist strap. Semiconductor devices must not be touched with bare hands. Similar precautions must be taken for printed circuit boards with mounted semiconductor devices.

### 2. Processing at power-on

The state of the product is undefined at the time when power is supplied. The states of internal circuits in the LSI are indeterminate and the states of register settings and pins are undefined at the time when power is supplied. In a finished product where the reset signal is applied to the external reset pin, the states of pins are not guaranteed from the time when power is supplied until the reset process is completed. In a similar way, the states of pins in a product that is reset by an on-chip power-on reset function are not guaranteed from the time when power is supplied until the power reaches the level at which resetting is specified.

### 3. Input of signal during power-off state

Do not input signals or an I/O pull-up power supply while the device is powered off. The current injection that results from input of such a signal or I/O pull-up power supply may cause malfunction and the abnormal current that passes in the device at this time may cause degradation of internal elements. Follow the guideline for input signal during power-off state as described in your product documentation.

### 4. Handling of unused pins

Handle unused pins in accordance with the directions given under handling of unused pins in the manual. The input pins of CMOS products are generally in the high-impedance state. In operation with an unused pin in the open-circuit state, extra electromagnetic noise is induced in the vicinity of the LSI, an associated shoot-through current flows internally, and malfunctions occur due to the false recognition of the pin state as an input signal become possible.

### 5. Clock signals

After applying a reset, only release the reset line after the operating clock signal becomes stable. When switching the clock signal during program execution, wait until the target clock signal is stabilized. When the clock signal is generated with an external resonator or from an external oscillator during a reset, ensure that the reset line is only released after full stabilization of the clock signal. Additionally, when switching to a clock signal produced with an external resonator or by an external oscillator while program execution is in progress, wait until the target clock signal is stable.

### 6. Voltage application waveform at input pin

Waveform distortion due to input noise or a reflected wave may cause malfunction. If the input of the CMOS device stays in the area between  $V_{IL}$  (Max.) and  $V_{IH}$  (Min.) due to noise, for example, the device may malfunction. Take care to prevent chattering noise from entering the device when the input level is fixed, and also in the transition period when the input level passes through the area between  $V_{IL}$  (Max.) and  $V_{IH}$  (Min.).

### 7. Prohibition of access to reserved addresses

Access to reserved addresses is prohibited. The reserved addresses are provided for possible future expansion of functions. Do not access these addresses as the correct operation of the LSI is not guaranteed.

### 8. Differences between products

Before changing from one product to another, for example to a product with a different part number, confirm that the change will not lead to problems. The characteristics of a microprocessing unit or microcontroller unit products in the same group but having a different part number might differ in terms of internal memory capacity, layout pattern, and other factors, which can affect the ranges of electrical characteristics, such as characteristic values, operating margins, immunity to noise, and amount of radiated noise. When changing to a product with a different part number, implement a system-evaluation test for the given product.



## Notice

1. Descriptions of circuits, software and other related information in this document are provided only to illustrate the operation of semiconductor products and application examples. You are fully responsible for the incorporation or any other use of the circuits, software, and information in the design of your product or system. Renesas Electronics disclaims any and all liability for any losses and damages incurred by you or third parties arising from the use of these circuits, software, or information.
  2. Renesas Electronics hereby expressly disclaims any warranties against and liability for infringement or any other claims involving patents, copyrights, or other intellectual property rights of third parties, by or arising from the use of Renesas Electronics products or technical information described in this document, including but not limited to, the product data, drawings, charts, programs, algorithms, and application examples.
  3. No license, express, implied or otherwise, is granted hereby under any patents, copyrights or other intellectual property rights of Renesas Electronics or others.
  4. You shall not alter, modify, copy, or reverse engineer any Renesas Electronics product, whether in whole or in part. Renesas Electronics disclaims any and all liability for any losses or damages incurred by you or third parties arising from such alteration, modification, copying or reverse engineering.
  5. Renesas Electronics products are classified according to the following two quality grades: "Standard" and "High Quality". The intended applications for each Renesas Electronics product depends on the product's quality grade, as indicated below.
    - "Standard": Computers; office equipment; communications equipment; test and measurement equipment; audio and visual equipment; home electronic appliances; machine tools; personal electronic equipment; industrial robots; etc.
    - "High Quality": Transportation equipment (automobiles, trains, ships, etc.); traffic control (traffic lights); large-scale communication equipment; key financial terminal systems; safety control equipment; etc.
- Unless expressly designated as a high reliability product or a product for harsh environments in a Renesas Electronics data sheet or other Renesas Electronics document, Renesas Electronics products are not intended or authorized for use in products or systems that may pose a direct threat to human life or bodily injury (artificial life support devices or systems; surgical implantations; etc.), or may cause serious property damage (space system; undersea repeaters; nuclear power control systems; aircraft control systems; key plant systems; military equipment; etc.). Renesas Electronics disclaims any and all liability for any damages or losses incurred by you or any third parties arising from the use of any Renesas Electronics product that is inconsistent with any Renesas Electronics data sheet, user's manual or other Renesas Electronics document.
6. When using Renesas Electronics products, refer to the latest product information (data sheets, user's manuals, application notes, "General Notes for Handling and Using Semiconductor Devices" in the reliability handbook, etc.), and ensure that usage conditions are within the ranges specified by Renesas Electronics with respect to maximum ratings, operating power supply voltage range, heat dissipation characteristics, installation, etc. Renesas Electronics disclaims any and all liability for any malfunctions, failure or accident arising out of the use of Renesas Electronics products outside of such specified ranges.
  7. Although Renesas Electronics endeavors to improve the quality and reliability of Renesas Electronics products, semiconductor products have specific characteristics, such as the occurrence of failure at a certain rate and malfunctions under certain use conditions. Unless designated as a high reliability product or a product for harsh environments in a Renesas Electronics data sheet or other Renesas Electronics document, Renesas Electronics products are not subject to radiation resistance design. You are responsible for implementing safety measures to guard against the possibility of bodily injury, injury or damage caused by fire, and/or danger to the public in the event of a failure or malfunction of Renesas Electronics products, such as safety design for hardware and software, including but not limited to redundancy, fire control and malfunction prevention, appropriate treatment for aging degradation or any other appropriate measures. Because the evaluation of microcomputer software alone is very difficult and impractical, you are responsible for evaluating the safety of the final products or systems manufactured by you.
  8. Please contact a Renesas Electronics sales office for details as to environmental matters such as the environmental compatibility of each Renesas Electronics product. You are responsible for carefully and sufficiently investigating applicable laws and regulations that regulate the inclusion or use of controlled substances, including without limitation, the EU RoHS Directive, and using Renesas Electronics products in compliance with all these applicable laws and regulations. Renesas Electronics disclaims any and all liability for damages or losses occurring as a result of your noncompliance with applicable laws and regulations.
  9. Renesas Electronics products and technologies shall not be used for or incorporated into any products or systems whose manufacture, use, or sale is prohibited under any applicable domestic or foreign laws or regulations. You shall comply with any applicable export control laws and regulations promulgated and administered by the governments of any countries asserting jurisdiction over the parties or transactions.
  10. It is the responsibility of the buyer or distributor of Renesas Electronics products, or any other party who distributes, disposes of, or otherwise sells or transfers the product to a third party, to notify such third party in advance of the contents and conditions set forth in this document.
  11. This document shall not be reprinted, reproduced or duplicated in any form, in whole or in part, without prior written consent of Renesas Electronics.
  12. Please contact a Renesas Electronics sales office if you have any questions regarding the information contained in this document or Renesas Electronics products.

(Note1) "Renesas Electronics" as used in this document means Renesas Electronics Corporation and also includes its directly or indirectly controlled subsidiaries.

(Note2) "Renesas Electronics product(s)" means any product developed or manufactured by or for Renesas Electronics.

(Rev.4.0-1 November 2017)

## Corporate Headquarters

TOYOSU FORESIA, 3-2-24 Toyosu,  
Koto-ku, Tokyo 135-0061, Japan  
[www.renesas.com](http://www.renesas.com)

## Trademarks

Renesas and the Renesas logo are trademarks of Renesas Electronics Corporation. All trademarks and registered trademarks are the property of their respective owners.

## Contact information

For further information on a product, technology, the most up-to-date version of a document, or your nearest sales office, please visit:  
[www.renesas.com/contact/](http://www.renesas.com/contact/).