

## RX Family

### I<sup>2</sup>C Bus Interface (RIIC) Module Using Firmware Integration Technology

---

#### Introduction

This application note describes the I<sup>2</sup>C bus interface (RIIC) module using firmware integration technology (FIT) for communications between devices using the I<sup>2</sup>C bus interface.

#### Target Device

- RX110, RX111, RX113 Groups
- RX130, RX13T Groups
- RX230, RX231, RX23E-A, RX23T, RX23W Groups
- RX24T, RX24U Groups
- RX64M Group
- RX65N, RX651 Groups
- RX66T Group
- RX66N Group
- RX671 Group
- RX71M Group
- RX72T Group
- RX72M Group
- RX72N Group

When using this application note with other Renesas MCUs, careful evaluation is recommended after making modifications to comply with the alternate MCU.

#### Target Compilers

- Renesas Electronics C/C++ Compiler Package for RX Family
- GCC for Renesas RX
- IAR C/C++ Compiler for Renesas RX

For details of the confirmed operation contents of each compiler, refer to "6.4 Operating Test Environment".

## Contents

1. Overview.....	4
1.1 RIIC FIT Module.....	4
1.2 Outline of the API.....	5
1.3 Overview of RIIC FIT Module.....	6
1.3.1 Specifications of RIIC FIT Module.....	6
1.3.2 Master Transmission.....	7
1.3.3 Master Reception.....	11
1.3.4 Slave Transmission and Reception.....	14
1.3.5 State Transition.....	18
1.3.6 Flags when Transitioning States.....	19
1.3.7 Arbitration-Lost Detection Function.....	20
1.3.8 Timeout Detection Function.....	20
2. API Information.....	21
2.1 Hardware Requirements.....	21
2.2 Software Requirements.....	21
2.3 Supported Toolchains.....	21
2.4 Usage of Interrupt Vector.....	22
2.5 Header Files.....	24
2.6 Integer Types.....	24
2.7 Configuration Overview.....	25
2.8 Code Size.....	30
2.9 Parameters.....	31
2.10 Return Values.....	31
2.11 Callback Functions.....	32
2.12 Adding the FIT Module to Your Project.....	32
2.13 “for”, “while” and “do while” statements.....	33
3. API Functions.....	34
3.1 R_RIIC_Open().....	34
3.2 R_RIIC_MasterSend().....	36
3.3 R_RIIC_MasterReceive().....	40
3.4 R_RIIC_SlaveTransfer().....	44
3.5 R_RIIC_GetStatus().....	48
3.6 R_RIIC_Control().....	50
3.7 R_RIIC_Close().....	52
3.8 R_RIIC_GetVersion().....	54
4. Pin Settings.....	55
5. Demo Projects.....	56
5.1 riic_mastersend_demo_rskrx64m.....	56
5.2 riic_masterreceive_demo_rskrx64m.....	56
5.3 riic_slavetransfer_demo_rskrx64m.....	56
5.4 riic_mastersend_demo_rskrx231.....	57
5.5 riic_masterreceive_demo_rskrx231.....	57
5.6 riic_slavetransfer_demo_rskrx231.....	57

## **RX Family I<sup>2</sup>C Bus Interface (RIIC) Module Using Firmware Integration Technology**

5.7	Adding a Demo to a Workspace .....	57
5.8	Downloading Demo Projects.....	57
6.	Appendices.....	58
6.1	Communication Method.....	58
6.1.1	States for API Operation.....	58
6.1.2	Events During API Operation .....	58
6.1.3	Protocol State Transitions.....	59
6.1.4	Protocol State Transition Table .....	63
6.1.5	Functions Used on Protocol State Transitions .....	64
6.1.6	Flag States on State Transitions .....	64
6.2	Interrupt Request Generation Timing .....	66
6.2.1	Master Transmission .....	66
6.2.2	Master Reception.....	67
6.2.3	Master Transmit/Receive.....	68
6.2.4	Slave Transmission .....	68
6.2.5	Slave Reception.....	69
6.2.6	Multi-Master Communication .....	69
6.3	Timeout Detection and Processing After the Detection.....	70
6.3.1	Detecting a Timeout with the Timeout Detection Function.....	70
6.3.2	Processing After a Timeout is Detected .....	70
6.4	Operating Test Environment.....	72
6.5	Troubleshooting .....	79
6.6	Sample Code .....	80
6.6.1	Example when Accessing One Slave Device Continuously with One Channel.....	80
7.	Reference Documents.....	85
	Related Technical Updates.....	86
	Revision History .....	87

## **1. Overview**

The I<sup>2</sup>C bus interface module using firmware integration technology (RIIC FIT module <sup>(1)</sup>) provides a method to transmit and receive data between the master and slave devices using the I<sup>2</sup>C bus interface (RIIC). The RIIC is in compliance with the NXP I<sup>2</sup>C-bus (Inter-IC-Bus) interface.

Note:

1. When the description says “module” in this document, it indicates the RIIC FIT module.

Features supported by this module are as follows:

- Master transmission, master reception, slave transmission, and slave reception
- Multi-master configuration that communicates between multiple masters and one slave.
- Communication mode can be standard or fast mode and the maximum communication rate is 400 kbps.  
However channel 0 of RX64M, RX71M, RX65N, RX66N, RX671, RX72M and RX72N supports fast mode plus and the maximum communication rate is 1 Mbps.

### **Limitations**

This module has the following limitations:

- (1) The module cannot be used with the DMAC and the DTC.
- (2) The NACK arbitration-lost detection function of the RIIC is not supported.
- (3) Transmission with 10-bit address is not supported.
- (4) Acceptance of the restart condition on slave device mode is not supported. Do not specify the address of a device in which this module is embedded as an address immediately following a restart condition.
- (5) The module does not support multiple interrupts.
- (6) API function calls except for the R\_RIIC\_GetStatus function is prohibited within a callback function.
- (7) Set the I flag to 1 to use interrupts.

### **1.1 RIIC FIT Module**

This module is implemented in a project and used as the API. Refer to 2.12 Adding the FIT Module to Your Project for details on implementing the module to the project.

## 1.2 Outline of the API

Table 1.1 lists the API Functions.

**Table 1.1 API Functions**

Item	Contents
R_RIIC_Open()	The function initializes the RIIC FIT module. This function must be called before calling any other API functions.
R_RIIC_MasterSend()	Starts master transmission. Changes the master transmit pattern according to the parameters. Operates batched processing until stop condition generation.
R_RIIC_MasterReceive()	Starts master reception. Changes the master receive pattern according to the parameters. Operates batched processing until stop condition generation.
R_RIIC_SlaveTransfer()	Performs slave transmission and reception. Changes the transmit and receive patterns according to the parameters.
R_RIIC_GetStatus()	Returns the state of this module.
R_RIIC_Control()	This function outputs conditions, Hi-Z from the SDA pin, and one-shot of the SCL clock. Also it resets the settings of this module. This function is mainly used when a communication error occurs.
R_RIIC_Close()	This function completes the RIIC communication and releases the RIIC used.
R_RIIC_GetVersion()	Returns the current version of this module.

**1.3 Overview of RIIC FIT Module**

**1.3.1 Specifications of RIIC FIT Module**

1. This module supports master transmission, master reception, slave transmission, and slave reception.
  - There are four transmit patterns that can be used for master transmission. Refer to 1.3.2 for details on master transmission.
  - Master reception and master transmit/receive can be selected for master reception. Refer to 1.3.3 for details on master reception.
  - Slave reception or slave transmission is performed according to the content of the data transmitted from the master. Refer to 1.3.4 for details on slave reception and slave transmission.
2. An interrupt occurs when any of the following operations completes: start condition generation, slave address transmission/reception, data transmission/reception, NACK detection, arbitration-lost detection, or stop condition generation. In the RIIC interrupt handling, the communication control function is called and the operation is continued.
3. When multiple RIIC channels are used, the module can control multiple channels. When the device used has multiple channels, simultaneous communication is available using multiple channels.
4. Multiple slave devices with different addresses on the same channel bus can be controlled. However, while communication is in progress (the period from start condition generation to stop condition generation), communication with other devices is not available. Figure 1.1 shows an Example of Controlling Multiple Slave Devices.

**When slave devices A and B are connected to channel 0.**

ST: Start condition, SP: Stop condition

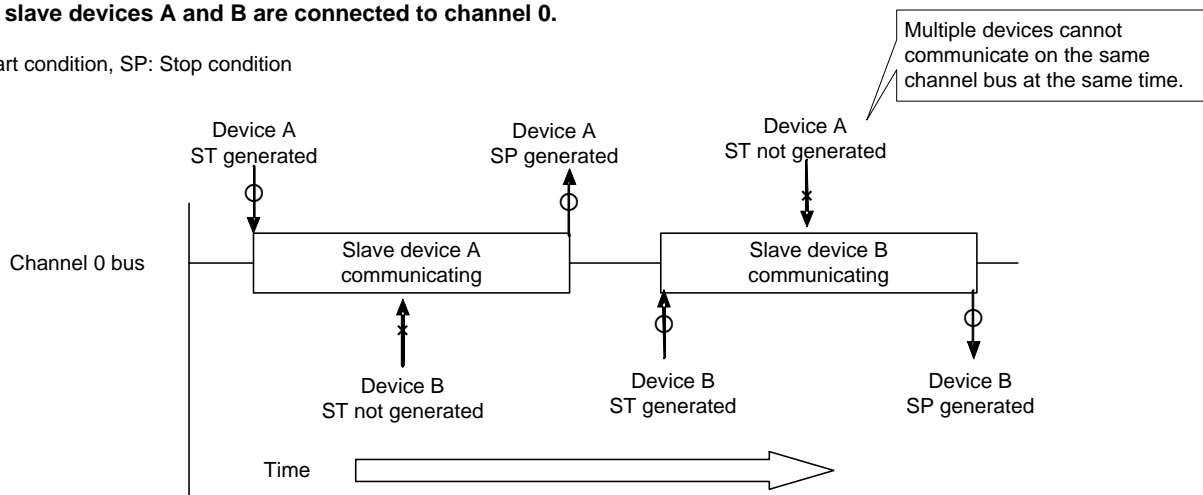

**Figure 1.1 Example of Controlling Multiple Slave Devices**

**1.3.2 Master Transmission**

The master device (master (RX MCU)) transmits data to the slave device (slave).

With this module, four patterns of waveforms can be generated for master transmission. A pattern is selected according to the arguments set in the parameters which are members of the I<sup>2</sup>C communication information structure. Figure 1.2 to Figure 1.5 show the transmit patterns. Refer to 2.9 Parameters for details on the I<sup>2</sup>C communication information structure.

(1) Pattern 1

The master (RX MCU) transmits data in two buffers for the first data and second data to the slave.

A start condition is generated and then the slave address is transmitted. The eighth bit specifies the transfer direction. This bit is set to 0 (write) when transmitting. Then the first data is transmitted. The first data is used when there is data to be transmitted in advance before performing the data transmission. For example, if the slave is an EEPROM, the EEPROM internal address can be transmitted. Next the second data is transmitted. The second data is the data to be written to the slave. When a data transmission has started and all data transmissions have completed, a stop condition is generated, and the bus is released.

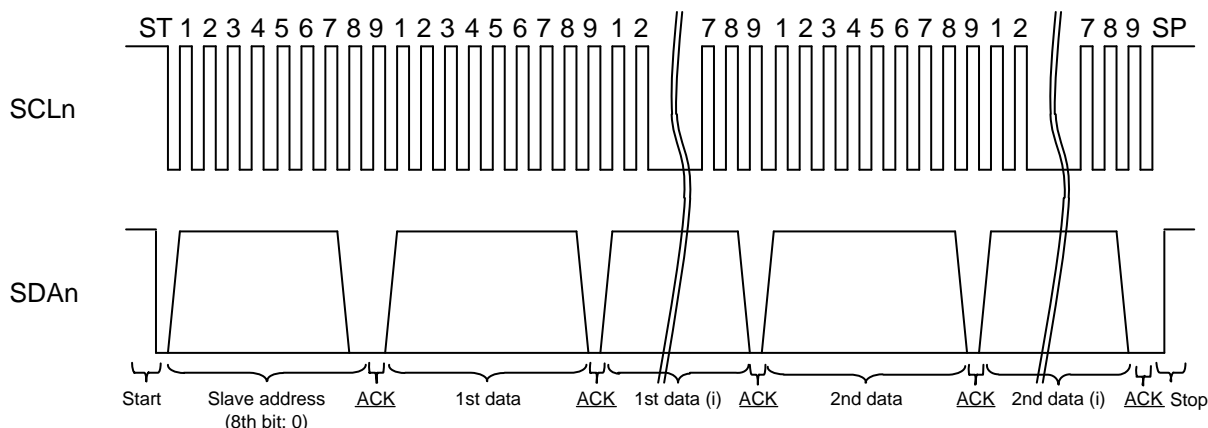

n: Channel number

ST: Start condition generation

SP: Stop condition generation

ACK: Acknowledge: 0

\* A signal with an underline indicates data transmission from the slave to the master.

**Figure 1.2 Signals for Pattern 1 of Master Transmission**

(2) Pattern 2

The master (RX MCU) transmits data in the buffer for the second data to the slave.

Operations from start condition generation through to slave address transmission are the same as the operations for pattern 1. Then the second data is transmitted without transmitting the first data. When all data transmissions have completed, a stop condition is generated and the bus is released.

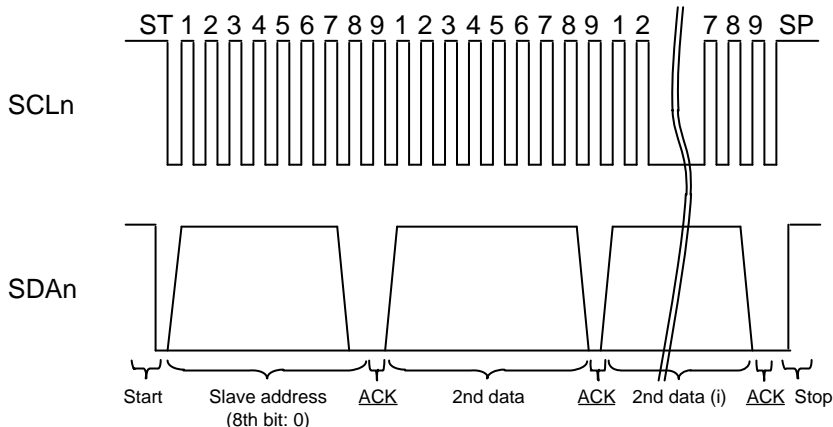

- n: Channel number
- ST: Start condition generation
- SP: Stop condition generation
- ACK: Acknowledge: 0
- \* A signal with an underline indicates data transmission from the slave to the master.

**Figure 1.3 Signals for Pattern 2 of Master Transmission**

(3) Pattern 3

The master (RX MCU) transmits only the slave address to the slave.

Operations from start condition generation through to slave address transmission are the same as the operations for pattern 1. After transmitting the slave address, if neither the first data nor the second data are set, data transmission is not performed, then a stop condition is generated, and the bus is released.

This pattern is useful for detecting connected devices or when performing acknowledge polling to verify the EEPROM rewriting state.

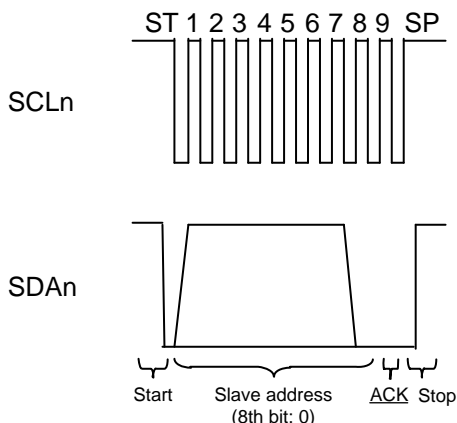

- n: Channel number
- ST: Start condition generation
- SP: Stop condition generation
- ACK: Acknowledge: 0
- \* A signal with an underline indicates data transmission from the slave to the master.

**Figure 1.4 Signals for Pattern 3 of Master Transmission**



## (4) Pattern 4

The master (RX MCU) transmits only a start condition and stop condition to the slave.

After a start condition is generated, if the slave address, first data, and second data are not set, slave address transmission and data transmission are not performed. Then a stop condition is generated and the bus is released.

This pattern is useful for just releasing the bus.

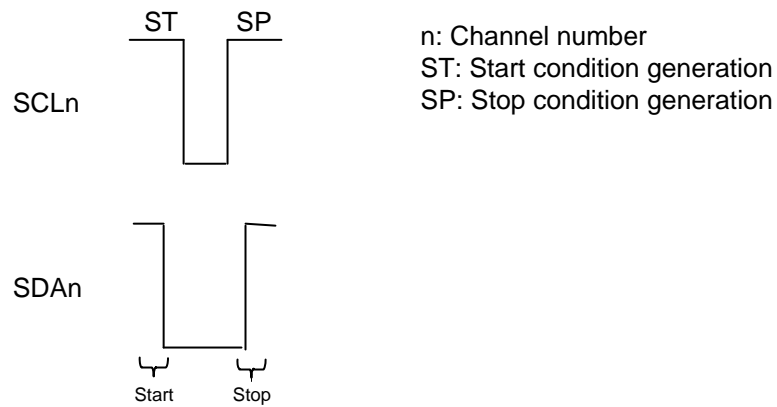

**Figure 1.5 Signals for Pattern 4 of Master Transmission**

Figure 1.6 shows the procedure of master transmission. The callback function is called after generating a stop condition. Specify the function name in the CallbackFunc of the I<sup>2</sup>C communication information structure member.

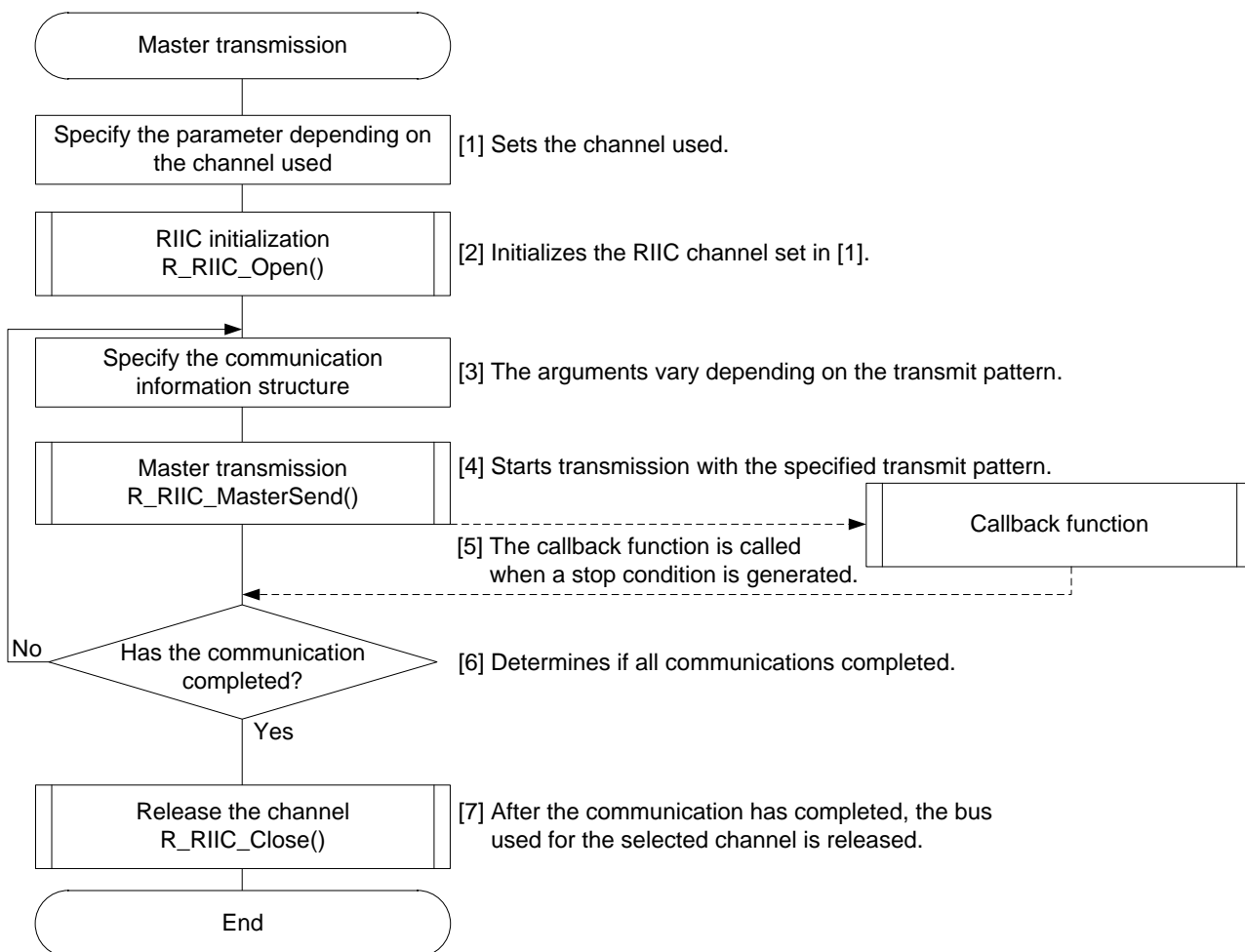

**Figure 1.6 Example of Master Transmission**

**1.3.3 Master Reception**

The master (RX MCU) receives data from the slave. This module supports master reception and master transmit/receive. The receive pattern is selected according to the arguments set in the parameters which are members of the I<sup>2</sup>C communication information structure. Figure 1.7 and Figure 1.8 show receive patterns. Refer to 2.9 Parameters for details on the I<sup>2</sup>C communication information structure.

(1) Master Reception

The master (RX MCU) receives data from the slave.

A start condition is generated and then the slave address is transmitted. The eighth bit specifies the transfer direction. This bit is set to 1 (read) when receiving. Then data reception starts. An ACK is transmitted each time 1-byte data is received except the last data. A NACK is transmitted when the last data is received to notify the slave that all data receptions have completed. Then a stop condition is generated and the bus is released.

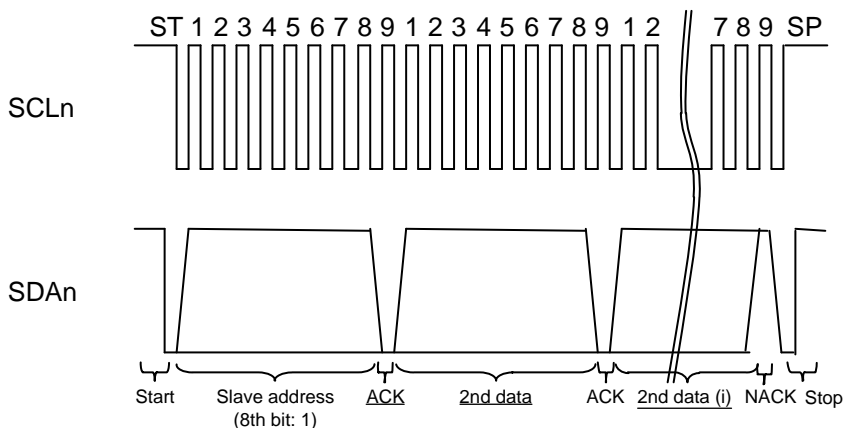

- n: Channel number
- ST: Start condition generation
- SP: Stop condition generation
- NACK: Acknowledge: 1
- ACK: Acknowledge: 0
- \* A signal with an underline indicates data transmission from the slave to the master.

**Figure 1.7 Signals for Master Reception**

(2) Master Transmit/Receive

The master (RX MCU) transmits data to the slave. After the transmission completes, a restart condition is generated, and the master receives data from the slave.

A start condition is generated and then the slave address is transmitted. The eighth bit specifies the transfer direction. This bit is set to 0 (write) when transmitting. Then the first data is transmitted. When the data transmission completes, a restart condition is generated and the slave address is transmitted. Then the eighth bit is set to 1 (read) and a data reception starts. An ACK is transmitted each time 1-byte data is received except the last data. A NACK is transmitted when the last data is received to notify the slave that all data receptions have completed. Then a stop condition is generated and the bus is released.

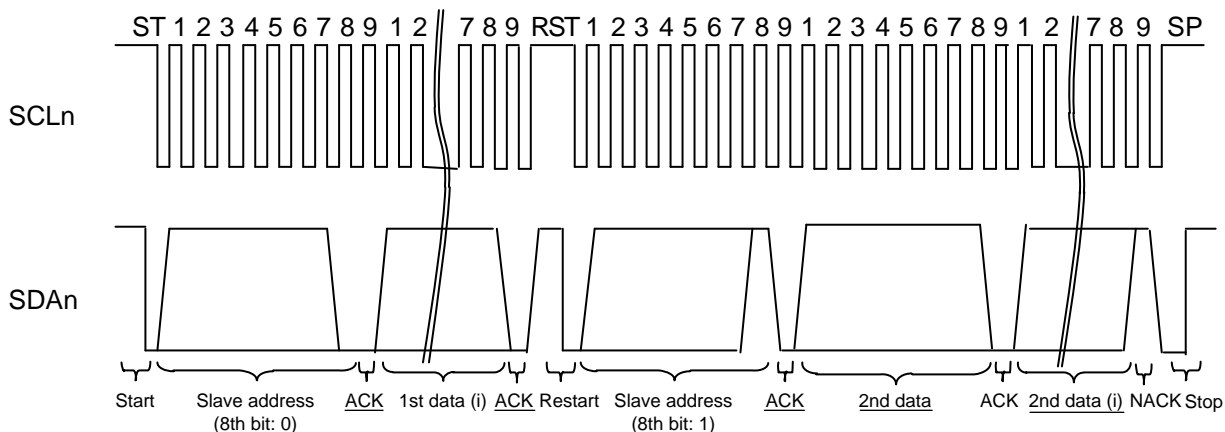

n: Channel number

ST: Start condition generation

SP: Stop condition generation

RST: Restart condition generation

NACK: Acknowledge: 1

ACK: Acknowledge: 0

\* A signal with an underline indicates data transmission from the slave to the master.

**Figure 1.8 Signals for Master Transmit/Receive**

Figure 1.9 shows the procedure of master reception. The callback function is called after generating a stop condition. Specify the function name in the CallBackFunc of the I<sup>2</sup>C communication information structure member.

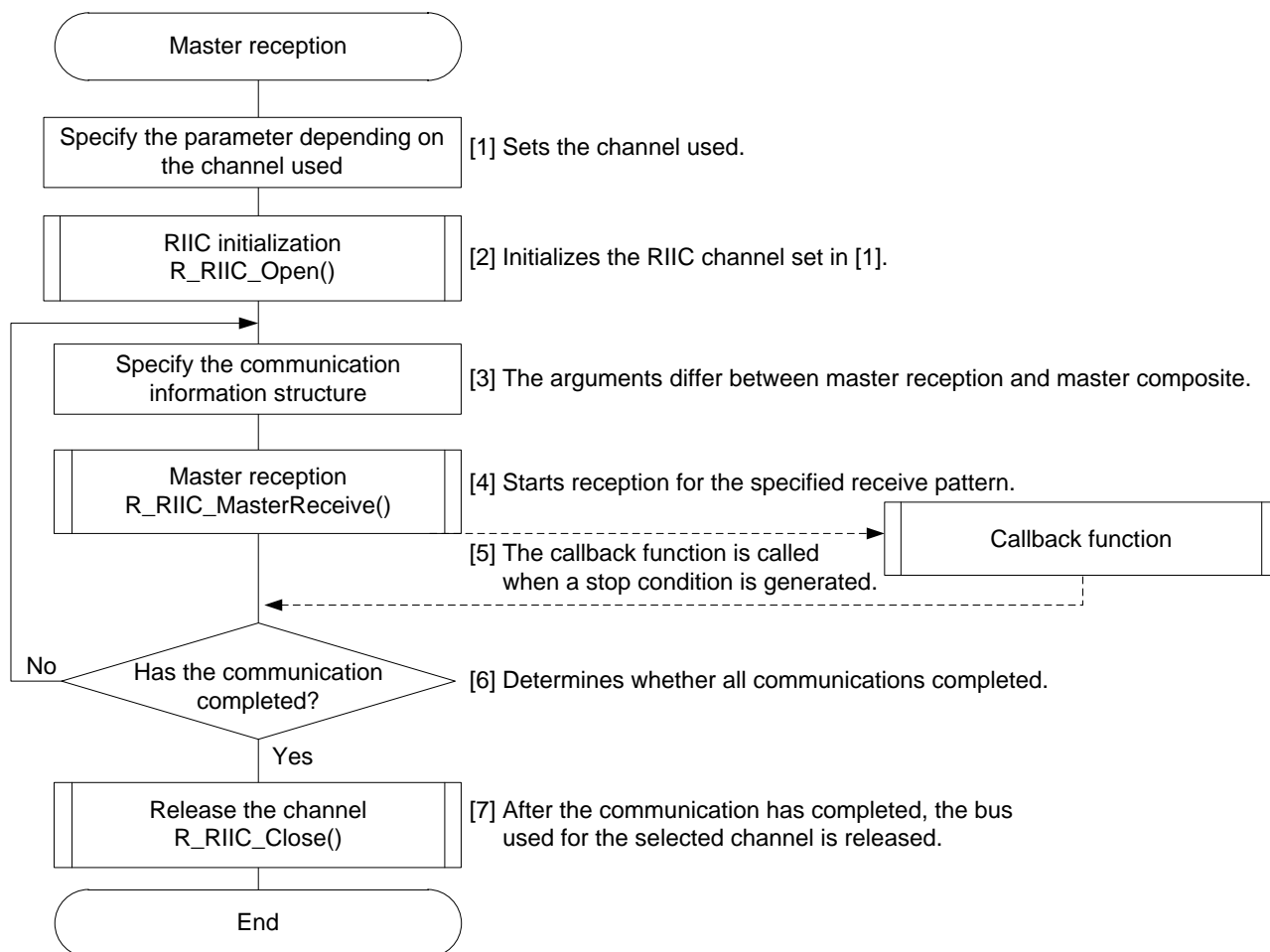

**Figure 1.9 Example of Master Reception**

**1.3.4 Slave Transmission and Reception**

The slave (RX MCU) receives data transmitted from the master. The slave transmits data by the transmit request from the master.

When the slave address specified by the master matches the slave address set in r\_riic\_config.h, slave transmission and reception starts. The module processes the operation automatically determining whether the operation is slave reception or slave transmission according to the eighth bit (transfer direction specify bit) of the slave address.

**(1) Slave Reception**

The slave (RX MCU) receives data from the master.

After a start condition generated by the master is detected, when the received slave address matches its own address and the eighth bit of the slave address is 0 (write), then the slave starts receive operation. When the last data (the number of data specified in the I<sup>2</sup>C communication information structure member) is received, a NACK is returned to the master to notify that all necessary data has been received. Figure 1.10 shows the Signals for Slave Reception.

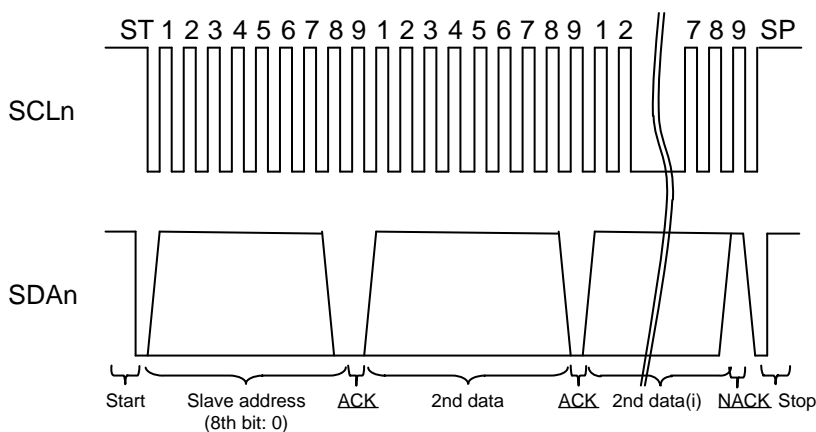

n: Channel number  
 ST: Start condition generation                      NACK: Acknowledge: 1  
 SP: Stop condition generation                      ACK: Acknowledge: 0  
 \* A signal with an underline indicates data transmission from the slave to the master.

**Figure 1.10 Signals for Slave Reception**

## RX Family I<sup>2</sup>C Bus Interface (RIIC) Module Using Firmware Integration Technology

Figure 1.11 shows the procedure of slave reception. The callback function is called after generating a stop condition. Specify the function name in the CallBackFunc of the I<sup>2</sup>C communication information structure member.

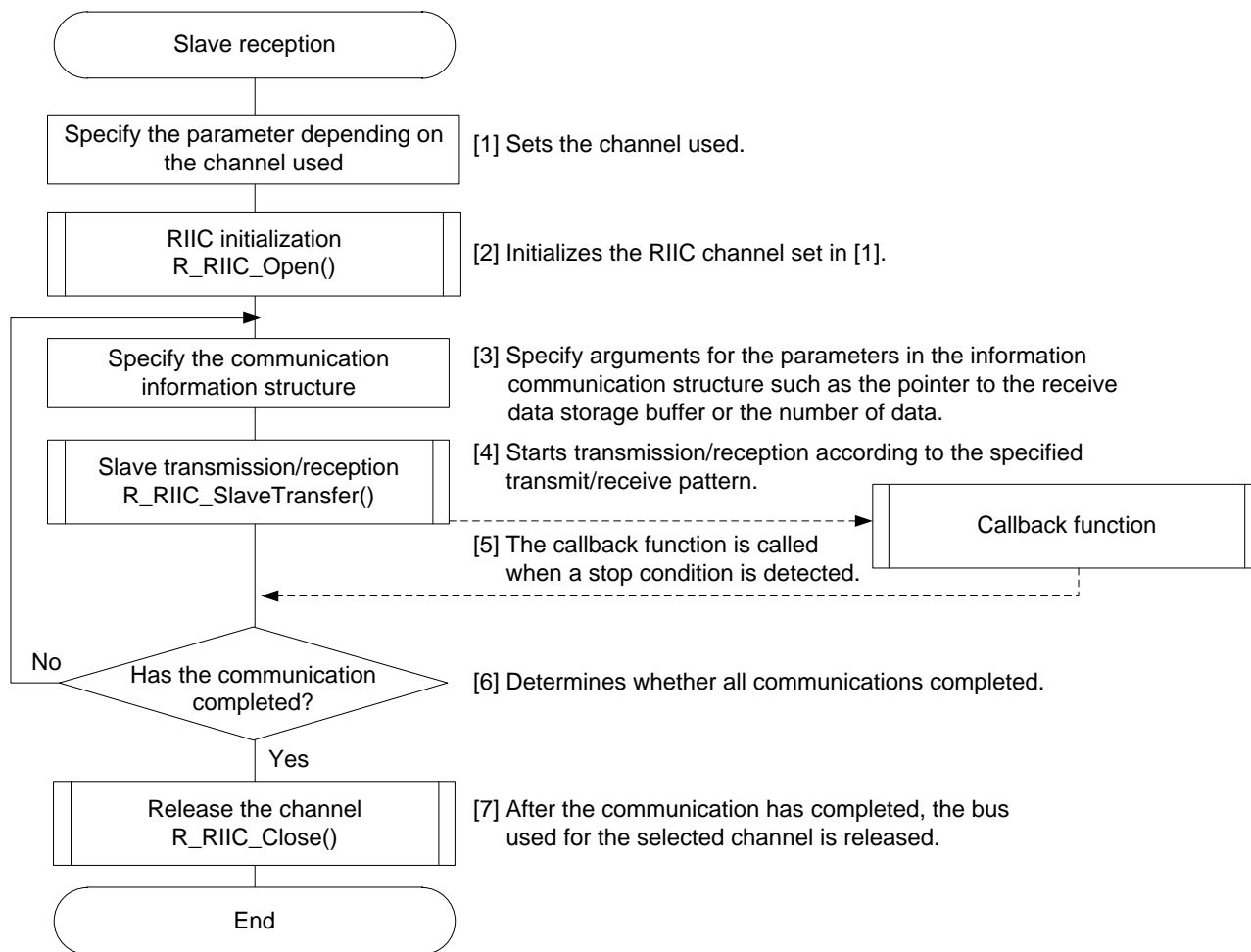
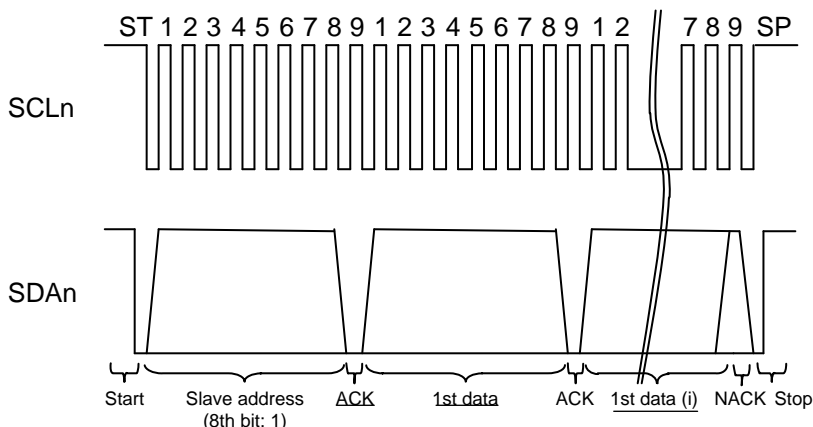

**Figure 1.11 Slave Reception**

(2) Slave Transmission

The slave (RX MCU) transmits data to the master.

After a start condition from the master is detected, when the slave address matches its own address and the eighth bit of the slave address is 1 (read), then the slave starts transmit operation. When the transmit request exceeds the number of data specified in the I<sup>2</sup>C communication information structure member, the slave transmits 0xFF as data. The slave continues transmit operation until a stop condition is detected. Figure 1.12 shows the Signals for Slave Transmission.



- n: Channel number
- ST: Start condition generation
- SP: Stop condition generation
- NACK: Acknowledge: 1
- ACK: Acknowledge: 0
- \* A signal with an underline indicates data transmission from the slave to the master.

**Figure 1.12 Signals for Slave Transmission**



Figure 1.13 shows the procedure of slave transmission. The callback function is called after generating a stop condition. Specify the function name in the CallBackFunc of the I<sup>2</sup>C communication information structure member.

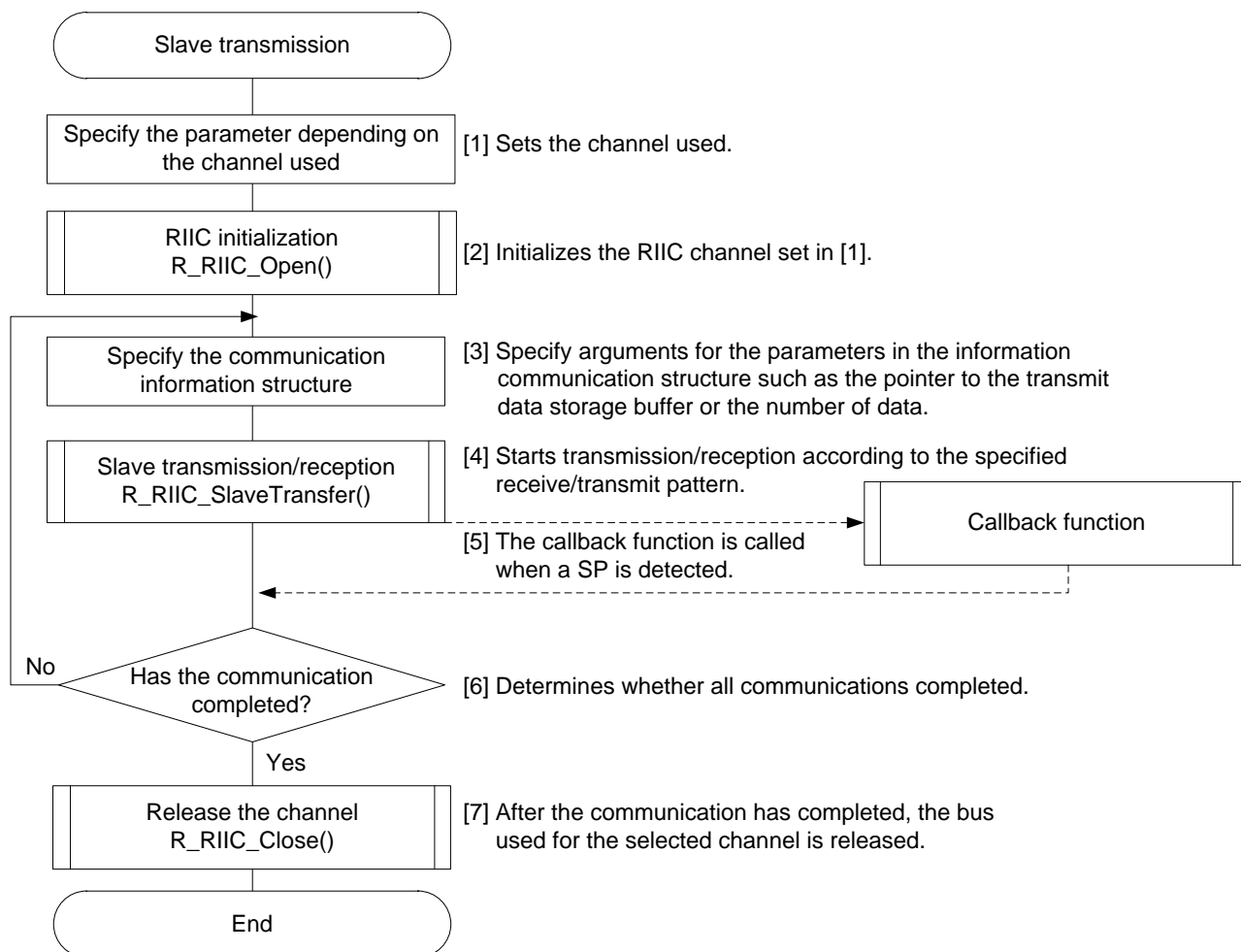

**Figure 1.13 Slave Transmission**

1.3.5 State Transition

Figure 1.14 shows the RIIC FIT Module State Transition Diagram.

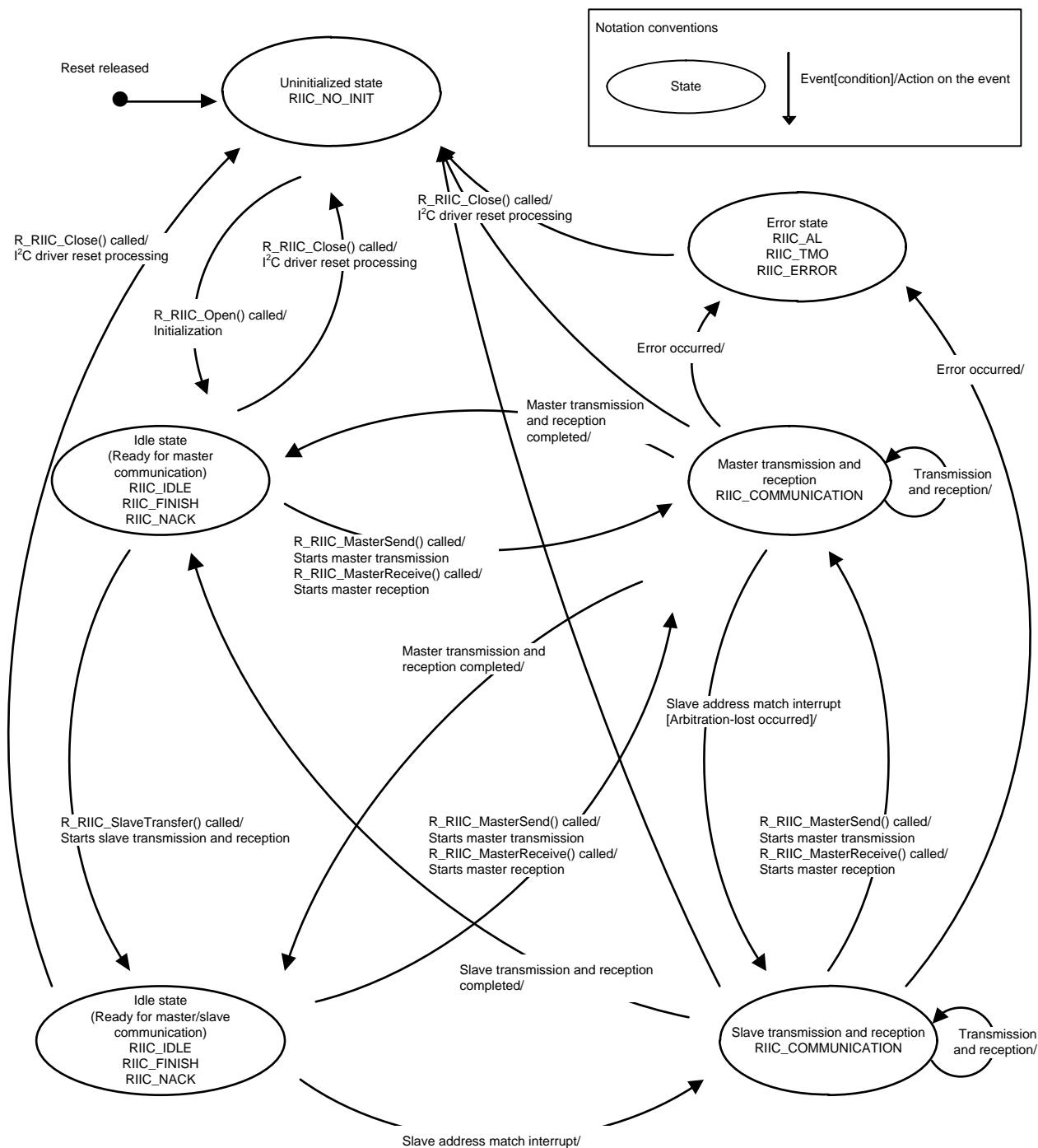

Figure 1.14 RIIC FIT Module State Transition Diagram

### 1.3.6 Flags when Transitioning States

dev\_sts is the device state flag and is one of the I<sup>2</sup>C communication information structure members. The flag stores the communication state of the device. Using this flag enables controlling multiple slaves on the same channel.

Table 1.2 lists the Device State Flags when Transitioning States.

**Table 1.2 Device State Flags when Transitioning States**

State	Device State Flag (dev_sts)
Uninitialized state	RIIC_NO_INIT
Idle states	RIIC_IDLE RIIC_FINISH RIIC_NACK
Communicating (master transmission, master reception, slave transmission, and slave reception)	RIIC_COMMUNICATION
Arbitration-lost detection state	RIIC_AL
Timeout detection state	RIIC_TMO
Error	RIIC_ERROR

### **1.3.7 Arbitration-Lost Detection Function**

This module detects arbitration-lost for the reasons below. The module does not support the arbitration-lost detection on slave transmission while the RIIC does.

(1) When a start condition is issued during the bus busy state:

If the module issues a start condition when the other master has already issued a start condition and occupied the bus (bus busy state), the module detects arbitration-lost.

(2) When the module issues a start condition after the other master issued a start condition though the bus is free:

When the module issues a start condition, it attempts to drive the SDA line low. However if the other master issued a start condition earlier, the signal level on the SDA line does not match the signal level output by the module. Then the module detects arbitration-lost.

(3) When multiple start conditions are issued at the same time:

If multiple masters issue start conditions at the same time, the module may determine that the start condition has been issued successfully on each device. Then each device starts communication. However, when any of the conditions described below occurs, the module detects arbitration-lost.

a. When data transmitted by masters are different:

The module compares the signal level on the SDA line with the signal level output by itself during communication. If these signals do not match while data is being transmitted including the slave address, the module detects arbitration-lost.

b. The numbers of data transmissions differ between masters while data sent by the masters are the same.

With the case other than the above a, i.e., the slave address and transmit data match, the module does not detect arbitration-lost. However if the number of data transmitted by masters differ, the module detects arbitration-lost.

### **1.3.8 Timeout Detection Function**

The timeout detection function can be enabled in this module (enabled as default). The RIIC can detect an abnormal bus state by monitoring that the SCL0 line is stuck low or high for a predetermined time.

The timeout detection function detects a bus hang up, i.e. the SCL line is held low or high, in the following period:

(1) The bus is busy in master mode.

(2) The RIIC's own slave address is detected and the bus is busy in slave mode.

(3) The bus is free while generation of a START condition is requested.

Refer to the following configuration options in "2.7 Configuration Overview" for details on enabling and disabling the timeout detection function.

- RIIC\_CFG\_CH0\_TMO\_ENABLE
- RIIC\_CFG\_CH2\_TMO\_ENABLE
- RIIC\_CFG\_CH0\_TMO\_DET\_TIME
- RIIC\_CFG\_CH2\_TMO\_DET\_TIME
- RIIC\_CFG\_CH0\_TMO\_LCNT
- RIIC\_CFG\_CH2\_TMO\_LCNT
- RIIC\_CFG\_CH0\_TMO\_HCNT
- RIIC\_CFG\_CH2\_TMO\_HCNT

Refer to 6.3 Timeout Detection and Processing After the Detection for detailed explanation when a timeout is detected.

### **2. API Information**

The FIT module provided with this application note has been confirmed to operate under the following conditions.

---

#### **2.1 Hardware Requirements**

---

This FIT module requires your MCU supports the following feature:

- RIIC

---

#### **2.2 Software Requirements**

---

This FIT module is dependent upon the following FIT modules:

- Board Support Package Module (r\_bsp) Rev.5.20 or higher

---

#### **2.3 Supported Toolchains**

---

This FIT module is tested and works with the following toolchain:

- Renesas RX Toolchain v.2.01.01
- Renesas RX Toolchain v.2.03.00
- Renesas RX Toolchain v.2.05.00
- Renesas RX Toolchain v.2.06.00
- Renesas RX Toolchain v.2.07.00
- Renesas RX Toolchain v.3.00.00
- Renesas RX Toolchain v.3.01.00
- Renesas RX Toolchain v.3.02.00
- Renesas RX Toolchain v.3.03.00

Refer to 6.4 Operating Test Environment for details.

---

### **2.4 Usage of Interrupt Vector**

---

The EEI interrupt, RXI interrupt, TXI interrupt, and TEI interrupt are enabled by execution of R\_RIIC\_MasterSend function, R\_RIIC\_MasterReceive function, or R\_RIIC\_SlaveTransfer function (with specified condition)(while the macro definition RIIC\_CFG\_CHi\_INCLUDE (i = 0 to 2) is 1).

Table 2.1 lists the interrupt vector used in the RIIC FIT Module.

**Table 2.1 Interrupt Vector used in the RIIC FIT Module**

Device	Contents
RX110 RX111 RX113 RX130 RX13T RX230 RX231 RX23E-A RX23T RX24T RX24U RX23W	EEI0 interrupt [channel 0] (vector no.: 246) RXI0 interrupt [channel 0] (vector no.: 247) TXI0 interrupt [channel 0] (vector no.: 248) TEI0 interrupt [channel 0] (vector no.: 249)
RX64M RX71M	RXI0 interrupt [channel 0] (vector no.: 52) TXI0 interrupt [channel 0] (vector no.: 53) RXI2 interrupt [channel 2] (vector no.: 54) TXI2 interrupt [channel 2] (vector no.: 55)  GROUPBL1 interrupt (vector no.: 111) <ul style="list-style-type: none"> <li>• TEI0 interrupt [channel 0] (group interrupt source no.: 13)</li> <li>• EEI0 interrupt [channel 0] (group interrupt source no.: 14)</li> <li>• TEI2 interrupt [channel 2] (group interrupt source no.: 15)</li> <li>• EEI2 interrupt [channel 2] (group interrupt source no.: 16)</li> </ul>
RX65N RX651 RX66N RX671 RX72M RX72N	RXI0 interrupt [channel 0] (vector no.: 52) TXI0 interrupt [channel 0] (vector no.: 53) RXI1 interrupt [channel 1] (vector no.: 50) TXI1 interrupt [channel 1] (vector no.: 51) RXI2 interrupt [channel 2] (vector no.: 54) TXI2 interrupt [channel 2] (vector no.: 55)  GROUPBL1 interrupt (vector no.: 111) <ul style="list-style-type: none"> <li>• TEI0 interrupt [channel 0] (group interrupt source no.: 13)</li> <li>• EEI0 interrupt [channel 0] (group interrupt source no.: 14)</li> <li>• TEI1 interrupt [channel 1] (group interrupt source no.: 28)</li> <li>• EEI1 interrupt [channel 1] (group interrupt source no.: 29)</li> <li>• TEI2 interrupt [channel 2] (group interrupt source no.: 15)</li> <li>• EEI2 interrupt [channel 2] (group interrupt source no.: 16)</li> </ul>
RX66T RX72T	RXI0 interrupt [channel 0] (vector no.: 52) TXI0 interrupt [channel 0] (vector no.: 53)  GROUPBL1 interrupt (vector no.: 111) <ul style="list-style-type: none"> <li>• TEI0 interrupt [channel 0] (group interrupt source no.: 13)</li> <li>• EEI0 interrupt [channel 0] (group interrupt source no.: 14)</li> </ul>

---

### **2.5 Header Files**

---

All API calls and their supporting interface definitions are located in `r_riic_rx_if.h`.

---

### **2.6 Integer Types**

---

This project uses ANSI C99. These types are defined in `stdint.h`.



**2.7 Configuration Overview**

The configuration options in this module are specified in `r_riic_rx_config.h` and `r_riic_rx_pin_config.h`. The option names and setting values are listed in the table below.

Configuration options in <code>r_riic_rx_config.h</code> (1/4)	
<b>RIIC_CFG_PARAM_CHECKING_ENABLE</b> - Default value = 1	Selects whether to include parameter checking in the code. - When this is set to 0, parameter checking is omitted. With this setting, the code size can be reduced. - When this is set to 1, parameter checking is included.
<b>RIIC_CFG_CHi_INCLUDED</b> <sup>(1)</sup> i = 0 to 2 - When i = 0, the default value = 1 - When i = 1 to 2, the default value = 0	Selects whether to use available channels. When not using the channel, set this to 0. - When this is set to 0, relevant processes for the channel are omitted from the code. - When this is set to 1, relevant processes for the channel are included in the code.
<b>RIIC_CFG_CH0_kBPS</b> - Default value = 400	Specifies the RIIC0 communication rate. Setting values for the bit rate register and internal reference clock selection bit are calculated using the setting values for <code>RIIC_CFG_CH0_kBPS</code> and the peripheral clock. - Target devices that do not support fast mode plus as the transfer speed. Specify a value less than or equal to 400. - For RX64M ,RX71M ,RX65N ,RX66N , RX671 ,RX72M and RX72N, specify a value less than or equal to 1000.
<b>RIIC_CFG_CH1_kBPS</b> <sup>(1)</sup> - Default value = 400	Specifies the RIIC1 communication rate. Setting values for the bit rate register and internal reference clock selection bit are calculated using the setting values for <code>RIIC_CFG_CH1_kBPS</code> and the peripheral clock. This should be set to 400 or less.
<b>RIIC_CFG_CH2_kBPS</b> <sup>(1)</sup> - Default value = 400	Specifies the RIIC2 communication rate. Setting values for the bit rate register and internal reference clock selection bit are calculated using the setting values for <code>RIIC_CFG_CH2_kBPS</code> and the peripheral clock. This should be set to 400 or less.
<b>RIIC_CFG_CHi_DIGITAL_FILTER</b> <sup>(1)</sup> i = 0 to 2 - When i = 0 to 2, the default value = 0	The number of noise filter stage of the specified RIIC channel can be selected. - When this is set to 0, the noise filter is disabled. - When this is set to a value from 1 to 4, values to enable the selected number of filters are selected for the noise filter stage selection bit and digital noise filter circuit enable bit.
<b>RIIC_CFG_PORT_SET_PROCESSING</b> - Default value = 1	Specifies whether to include processing for port setting <sup>(*)</sup> in the code.  * Processing for port setting is the setting to use ports selected by <code>R_RIIC_CFG_RIICi_SCLi_PORT</code> , <code>R_RIIC_CFG_RIICi_SCLi_BIT</code> , <code>R_RIIC_CFG_RIICi_SDAi_PORT</code> , and <code>R_RIIC_CFG_RIICi_SDAi_BIT</code> as pins SCL and SDA.  - When this is set to 0, processing for port setting is omitted from the code. - When this is set to 1, processing for port setting is included in the code.

Note:

1. This setting is invalid for target devices that do not support the corresponding channel.

Configuration options in <i>r_riic_config.h</i> (2/4)	
<p><b>RIIC_CFG_CHi_MASTER_MODE</b> <sup>(1)</sup>  <i>i</i> = 0 to 2                      - When <i>i</i> = 0 to 2, the default value = 0</p>	<p>The master arbitration lost detection function of the specified RIIC channel can be enable or disable.                      Set this to 1 (enabled) when using multi-master.                      - When this is set to 0, the master arbitration-lost detection is disabled.                      - When this is set to 1, the master arbitration-lost detection is enabled.</p>
<p><b>RIIC_CFG_CHi_SLV_ADDR0_FORMAT</b> *1 <sup>(1)</sup>  <b>RIIC_CFG_CHi_SLV_ADDR1_FORMAT</b> *2 <sup>(1)</sup>  <b>RIIC_CFG_CHi_SLV_ADDR2_FORMAT</b> *2 <sup>(1)</sup>  <i>i</i> = 0 to 2                      *1: When <i>i</i> = 0 to 2, the default value = 1                      *2: When <i>i</i> = 0 to 2, the default value = 0</p>	<p>The slave address format can be selected as 7 bits or 10 bits for the specified RIIC channel.                      - When this is set to 0, the slave address is not set.                      - When this is set to 1, the 7-bit slave address format is set.                      - When this is set to 2, the 10-bit slave address format is set.</p>
<p><b>RIIC_CFG_CHi_SLV_ADDR0</b> *1 <sup>(1)</sup>  <b>RIIC_CFG_CHi_SLV_ADDR1</b> *2 <sup>(1)</sup>  <b>RIIC_CFG_CHi_SLV_ADDR2</b> *2 <sup>(1)</sup>  <i>i</i> = 0 to 2                      *1: When <i>i</i> = 0 to 2, the default value = 0x0025                      *2: When <i>i</i> = 0 to 2, the default value = 0x0000</p>	<p>This set the slave address of the specified RIIC channel.                      Available bits of the setting value vary depending on the setting value of the RIIC_CFG_CHi_SLV_ADDRj_FORMAT. (<i>j</i> = 0 to 2)                      When RIIC_CFG_CHi_SLV_ADDRj_FORMAT is:                      0: The setting value is ignored.                      1: The lower 7 bits of the setting value are used.                      2: The lower 10 bits of the setting value are used.</p>
<p><b>RIIC_CFG_CHi_SLV_GCA_ENABLE</b> <sup>(1)</sup>  <i>i</i> = 0 to 2                      - When <i>i</i> = 0 to 2, the default value = 0</p>	<p>The general call address of the specified RIIC channel can be enable or disable.                      - When this is set to 0: General call address is disabled.                      - When this is set to 1: General call address is enabled.</p>
<p><b>RIIC_CFG_CHi_RXI_INT_PRIORITY</b> <sup>(1)</sup>  <i>i</i> = 0 to 2                      - When <i>i</i> = 0 to 2, the default value = 1</p>	<p>The priority level of the receive data full interrupt (RXIi) of the specified RIIC channel can be selected.                      Specify the level from 1 to 15.</p>
<p><b>RIIC_CFG_CHi_TXI_INT_PRIORITY</b> <sup>(1)</sup>  <i>i</i> = 0 to 2                      - When <i>i</i> = 0 to 2, the default value = 1</p>	<p>The priority level of the transmit data empty interrupt (TXIi) of the specified RIIC channel can be selected.                      Specify the level from 1 to 15.</p>

Note:

2. This setting is invalid for target devices that do not support the corresponding channel.

Configuration options in <i>r_riic_config.h</i> (3/4)	
<b>RIIC_CFG_CHi_EEI_INT_PRIORITY</b> <sup>(1)</sup> <sup>(2)</sup> <i>i = 0 to 2</i> - When <i>i = 0 to 2</i> , the default value = 1	The priority level of the communication error / event occurrence interrupt (EEI) of the specified RIIC channel can be selected. Specify the level from 1 to 15. Do not set this option to a value lower than the priority level specified with RIIC_CFG_CHi_RXI_INT_PRIORITY or RIIC_CFG_CHi_TXI_INT_PRIORITY.
<b>RIIC_CFG_CHi_TEI_INT_PRIORITY</b> <sup>(1)</sup> <sup>(2)</sup> <i>i = 0 to 2</i> - When <i>i = 0 to 2</i> , the default value = 1	The priority level of the transmission end interrupt (TEI) of the specified RIIC channel can be selected. Specify the level from 1 to 15. Do not set this option to a value lower than the priority level specified with RIIC_CFG_CHi_RXI_INT_PRIORITY or RIIC_CFG_CHi_TXI_INT_PRIORITY.
<b>RIIC_CFG_CHi_TMO_ENABLE</b> <sup>(2)</sup> <i>i = 0 to 2</i> - When <i>i = 0 to 2</i> , the default value = 1	The timeout detection function of the specified RIIC channel can be enabled. - When this is set to 0: RIICi timeout detection function is disabled. - When this is set to 1: RIICi timeout detection function is enabled.
<b>RIIC_CFG_CHi_TMO_DET_TIME</b> <sup>(2)</sup> <i>i = 0 to 2</i> - When <i>i = 0 to 2</i> , the default value = 0	You can select the timeout detection time of the specified RIIC channel.- When this is set to 0, long mode is selected. - When this is set to 1, short mode is selected.

**Note:**

1. The priority level cannot be set individually in devices that group EEI0, TEI0, EEI2, and TEI2 as the BL1 interrupt. In this case, the priority levels for EEI0, TEI0, EEI2, and TEI2 will be unified to all be the maximum value of the individual priority levels set in *r\_riic\_config.h*. However if the other module specifies a greater value than the value specified for the BL1 priority level in the RIIC, the greater value will be used.  
 For EEI0 and TEI0 interrupt priority levels, do not set values smaller than the priority levels for RXI0 and TXI0. Also, for EEI2 and TEI2 interrupt priority levels, do not set values smaller than the priority levels for RXI2 and TXI2.
2. This setting is invalid for target devices that do not support the corresponding channel.

Configuration options in <i>r_riic_config.h</i> (4/4)	
<p><b>RIIC_CFG_CHi_TMO_LCNT</b> <sup>(1)</sup>  <i>i = 0 to 2</i>                      - When <i>i = 0 to 2</i>, the default value = 1</p>	<p>After enabling the timeout detection function of specified RIIC channel, during the time SCLi line is low, count-up of the internal counter for the timeout detection function can be enabled.</p> <ul style="list-style-type: none"> <li>- When this is set to 0, counting up is disabled while the SCLi line is held low.</li> <li>- When this is set to 1, counting up is enabled while the SCLi line is held low.</li> </ul>
<p><b>RIIC_CFG_CHi_TMO_HCNT</b> <sup>(1)</sup>  <i>i = 0 to 2</i>                      - When <i>i = 0 to 2</i>, the default value = 1</p>	<p>After enabling the specified RIIC timeout detection function, during the time SCLi line is high, the count-up of the internal counter for the timeout detection function can be enabled.</p> <ul style="list-style-type: none"> <li>- When this is set to 0, counting up is disabled while the SCL0 line is held high.</li> <li>- When this is set to 1, counting up is enabled while the SCL0 line is held high.</li> </ul>
<p><b>RIIC_CFG_BUS_CHECK_COUNTER</b>                      - Default value = 1000</p>	<p>Specifies the timeout counter (number of times to perform bus checking) when the RIIC API function performs bus checking. Specify a value less than or equal to 0xFFFFFFFF. The bus checking is performed in the following timings:</p> <ul style="list-style-type: none"> <li>- Before generating a start condition</li> <li>- After detecting a stop condition</li> <li>- After generating each condition using the RIIC control function (R_RIIC_Control function)</li> <li>- After generating the SCL one-shot pulse using the RIIC control function (R_RIIC_Control function).</li> </ul> <p>With the bus checking, when the bus is busy, the timeout counter is decremented by the software until the bus becomes free. When the counter reaches 0, the API determines that a timeout has occurred and returns an error (Busy) as the return value.</p> <p>* The timeout counter is used for the bus not to be locked. Therefore specify the value greater than or equal to the time for that the other device holds the SCL pin low.</p> <p>Setting time for the timeout (ns) <math>\approx \left(\frac{1}{f_{CLK}} \text{ (Hz)}\right) \times \text{counter value} \times 10</math></p>

**Note:**

1. This setting is invalid for target devices that do not support the corresponding channel.

Configuration options in <i>r_riic_rx_config.h</i>	
<p><b>R_RIIC_CFG_RIICi_SCLi_PORT</b>  <i>i</i> = 0 to 2                      - When <i>i</i> = 0, the default value = '1'                      - When <i>i</i> = 1, the default value = '2'                      - When <i>i</i> = 2, the default value = '1'</p>	<p>Selects port groups used as the SCL pins.                      Specify the value as an ASCII code in the range '0' to 'J'.</p>
<p><b>R_RIIC_CFG_RIICi_SCLi_BIT</b>  <i>i</i> = 0 to 2                      - When <i>i</i> = 0, the default value = '2'                      - When <i>i</i> = 1, the default value = '1'                      - When <i>i</i> = 2, the default value = '6'</p>	<p>Selects pins used as the SCL pins.                      Specify the value as an ASCII code in the range '0' to '7'.</p>
<p><b>R_RIIC_CFG_RIICi_SDAi_PORT</b>  <i>i</i> = 0 to 2                      - When <i>i</i> = 0, the default value = '1'                      - When <i>i</i> = 1, the default value = '2'                      - When <i>i</i> = 2, the default value = '1'</p>	<p>Selects port groups used as the SDA pins.                      Specify the value as an ASCII code in the range '0' to 'J'.</p>
<p><b>R_RIIC_CFG_RIICi_SDAi_BIT</b>  <i>i</i> = 0 to 2                      - When <i>i</i> = 0, the default value = '3'                      - When <i>i</i> = 1, the default value = '0'                      - When <i>i</i> = 2, the default value = '7'</p>	<p>Selects pins used as the SDA pins.                      Specify the value as an ASCII code in the range '0' to '7'.</p>

## 2.8 Code Size

Typical code sizes associated with this module are listed below. Information is listed for a single representative device of the RX100 Series, RX200 Series, and RX600 Series, respectively.

The ROM (code and constants) and RAM (global data) sizes are determined by the build-time configuration options described in 2.7, Configuration Overview. The table lists reference values when the C compiler's compile options are set to their default values, as described in 2.3, Supported Toolchains. The compile option default values are optimization level: 2, optimization type: for size, and data endianness: little-endian. The code size varies depending on the C compiler version and compile options.

The values in the table below are confirmed under the following conditions.

Module Revision: r\_riic\_rx rev2.47

Compiler Version: Renesas Electronics C/C++ Compiler Package for RX Family V3.02.00

(The option of “-lang = c99” is added to the default settings of the integrated development environment.)

GCC for Renesas RX 8.03.00.202002

(The option of “-std=gnu99” is added to the default settings of the integrated development environment.)

IAR C/C++ Compiler for Renesas RX version 4.14.1

(The default settings of the integrated development environment.)

Configuration Options: Default settings

ROM, RAM and Stack Memory Usage								
Device	Category		Memory Used					
			Renesas Compiler		GCC		IAR Compiler	
			With Parameter Checking	Without Parameter Checking	With Parameter Checking	Without Parameter Checking	With Parameter Checking	Without Parameter Checking
RX130	ROM	1 channel used	10106 bytes	9826 bytes	18496 bytes	18088 bytes	13203 bytes	12875 bytes
	RAM	1 channel used	37 bytes		40 bytes		26 bytes	
	STACK *1		348 bytes		-		356 bytes	
RX231	ROM	1 channel used	8961 bytes	8681 bytes	16504 bytes	16072 bytes	11921 bytes	11595 bytes
	RAM	1 channel used	37 bytes		40 bytes		26 bytes	
	STACK *1		324 bytes		-		352 bytes	
RX64M	ROM	1 channel used	9156 bytes	8876 bytes	16704 bytes	16272 bytes	12090 bytes	11760 bytes
		2 channels used	10129 bytes	9942 bytes	19088 bytes	18656 bytes	13745 bytes	13401 bytes
	RAM	1 channel used	111 bytes		112 bytes		70 bytes	
		2 channels used	111 bytes		112 bytes		70 bytes	
	STACK *1		324 bytes		-		356 bytes	

Note 1. The sizes of maximum usage stack of Interrupts functions is included.

### 2.9 Parameters

---

This section describes the structure whose members are API parameters. This structure is located in `r_riic_rx_if.h` as are the prototype declarations of API functions.

The contents of the structure are referred and updated during communication. Do not rewrite the structure during communication (RIIC\_COMMUNICATION).

```
typedef volatile struct
{
    uint8_t rsv2; /* Reserved area */
    uint8_t rsv1; /* Reserved area */
    riic_ch_dev_status_t dev_sts; /* Device state flag */
    uint8_t ch_no; /* Channel number of the used device */
    riic_callback callbackfunc; /* Callback function */
    uint32_t cnt2nd; /* Second data counter (number of bytes) */
    uint32_t cnt1st; /* First data counter (number of bytes) */
    uint8_t *p_data2nd; /* Pointer to the second data storage buffer */
    uint8_t *p_data1st; /* Pointer to the first data storage buffer */
    uint8_t *p_slv_adr; /* Pointer to the slave address storage buffer */
} riic_info_t;
```

### 2.10 Return Values

---

This section describes return values of API functions. This enumeration is located in `r_riic_rx_if.h` as are the prototype declarations of API functions.

```
typedef enum
{
    RIIC_SUCCESS = 0U, /* Function processing completed successfully */
    RIIC_ERR_LOCK_FUNC, /* The RIIC is used by another module */
    RIIC_ERR_INVALID_CHAN, /* Nonexistent channel is specified */
    RIIC_ERR_INVALID_ARG, /* Invalid parameter is specified */
    RIIC_ERR_NO_INIT, /* Uninitialized state */
    RIIC_ERR_BUS_BUSY, /* Bus is busy */
    RIIC_ERR_AL, /* The function was called while an arbitration-lost has been detected */
    RIIC_ERR_TMO, /* Timeout is detected */
    RIIC_ERR_OTHER, /* Other error */
} riic_return_t;
```

### 2.11 Callback Functions

---

In this module, a callback function set up by the user is called when either of the following conditions is met and an EEI interrupt request occurs.

- (1) The communication operation (Master Transmission, Master Reception, Master Transmit/Receive, Slave Transmission, Slave Reception) is completed and stop condition is issued.
- (2) A timeout was detected during communication operation (Master Transmission, Master Reception, Master Transmit/Receive, Slave Transmission, Slave Reception). <sup>(1)</sup>

Note:

1. When the timeout detection function is enabled in RIIC\_CFG\_CHi\_TMO\_ENABLE (i = 0 to 2) in section 2.7, Configuration Overview.

The callback function is set up by storing the address of the callback function in the callbackfunc structure member described in section 2.9, Parameters and then calling function R\_RIIC\_MasterSend(), R\_RIIC\_MasterReceive(), R\_RIIC\_SlaveTransfer().

API function calls except for the R\_RIIC\_GetStatus function is prohibited within a callback function.

### 2.12 Adding the FIT Module to Your Project

---

This module must be added to each project in which it is used. Renesas recommends the method using the Smart Configurator described in (1) or (3) or (5) below. However, the Smart Configurator only supports some RX devices. Please use the methods of (2) or (4) for RX devices that are not supported by the Smart Configurator.

- (1) Adding the FIT module to your project using the Smart Configurator in e<sup>2</sup> studio  
By using the Smart Configurator in e<sup>2</sup> studio, the FIT module is automatically added to your project. Refer to “RX Smart Configurator User’s Guide: e<sup>2</sup> studio (R20AN0451)” for details.
- (2) Adding the FIT module to your project using the FIT Configurator in e<sup>2</sup> studio  
By using the FIT Configurator in e<sup>2</sup> studio, the FIT module is automatically added to your project. Refer to “RX Family Adding Firmware Integration Technology Modules to Projects (R01AN1723)” for details.
- (3) Adding the FIT module to your project using the Smart Configurator in CS+  
By using the Smart Configurator Standalone version in CS+, the FIT module is automatically added to your project. Refer to “RX Smart Configurator User’s Guide: CS+ (R20AN0470)” for details.
- (4) Adding the FIT module to your project in CS+  
In CS+, please manually add the FIT module to your project. Refer to “RX Family Adding Firmware Integration Technology Modules to CS+ Projects (R01AN1826)” for details.
- (5) Adding the FIT module to your project using the Smart Configurator in IAREW  
By using the Smart Configurator Standalone version, the FIT module is automatically added to your project. Refer to “RX Smart Configurator User’s Guide: IAREW (R20AN0535)” for details.



### 2.13 “for”, “while” and “do while” statements

In this module, “for”, “while” and “do while” statements (loop processing) are used in processing to wait for register to be reflected and so on. For these loop processing, comments with “WAIT\_LOOP” as a keyword are described. Therefore, if user incorporates fail-safe processing into loop processing, user can search the corresponding processing with “WAIT\_LOOP”.

The following shows example of description.

while statement example :

```
/* WAIT_LOOP */
while(0 == SYSTEM.OSCOVFSR.BIT.PLOVF)
{
    /* The delay period needed is to make sure that the PLL has stabilized. */
}
```

for statement example :

```
/* Initialize reference counters to 0. */
/* WAIT_LOOP */
for (i = 0; i < BSP_REG_PROTECT_TOTAL_ITEMS; i++)
{
    g_protect_counters[i] = 0;
}
```

do while statement example :

```
/* Reset completion waiting */
do
{
    reg = phy_read(ether_channel, PHY_REG_CONTROL);
    count++;
} while ((reg & PHY_CONTROL_RESET) && (count < ETHER_CFG_PHY_DELAY_RESET)); /* WAIT_LOOP */
```

## 3. API Functions

### 3.1 R\_RIIC\_Open()

This function initializes the RIIC FIT module. This function must be called before calling any other API functions.

#### Format

```
riic_return_t R_RIIC_Open(  
    riic_info_t* p_riic_info    /* Structure data */  
)
```

#### Parameters

*\*p\_riic\_info*

This is the pointer to the I<sup>2</sup>C communication information structure.

Only the member of the structure used in this function is described here. Refer to 2.9 Parameters for details on the structure.

The contents of the structure are referred and updated during communication. Do not rewrite the structure during communication (RIIC\_COMMUNICATION) and when an error has occurred (RIIC\_TMO and RIIC\_ERROR).

For the parameter which has '(to be updated)' in the comment below, the argument for the parameter will be updated during the API execution.

```
riic_ch_dev_status_t dev_sts; /* Device state flag (to be updated) */  
uint8_t ch_no; /* Channel number */
```

#### Return Values

```
RIIC_SUCCESS, /* Processing completed successfully */  
RIIC_ERR_LOCK_FUNC, /* The API is locked by the other task. */  
RIIC_ERR_INVALID_CHAN, /* Nonexistent channel */  
RIIC_ERR_INVALID_ARG, /* Invalid parameter */  
RIIC_ERR_OTHER, /* The event occurred is invalid in the current state. */
```

#### Properties

Prototyped in r\_riic\_rx\_if.h.

#### Description

Performs the initialization to start the RIIC communication. Sets the RIIC channel specified by the parameter. If the state of the channel is 'uninitialized (RIIC\_NO\_INIT)', the following processes are performed.

- Setting the state flag
- Setting I/O ports
- Allocating I<sup>2</sup>C output ports
- Cancelling RIIC module-stop state
- Initializing variables used by the API
- Initializing the RIIC registers used for the RIIC communication
- Disabling the RIIC interrupts

### **Example**

```
volatile riic_return_t  ret;  
riic_info_t            iic_info_m;  
  
iic_info_m.dev_sts = RIIC_NO_INIT;  
iic_info_m.ch_no   = 0;  
  
ret = R_RIIC_Open(&iic_info_m);
```

### **Special Notes**

None

### 3.2 R\_RIIC\_MasterSend()

Starts master transmission. Changes the transmit pattern according to the parameters. Operates batched processing until stop condition generation.

#### Format

```
riic_return_t R_RIIC_MasterSend(  
    riic_info_t * p_riic_info    /* Structure data */  
)
```

#### Parameters

*\*p\_riic\_info*

This is the pointer to the I<sup>2</sup>C communication information structure. The transmit patterns can be selected from four patterns by the parameter setting. Refer to Special Notes in this section for available settings and the setting values for each transmit pattern. Also refer to 1.3.2 Master Transmission for details of each pattern.

Only members of the structure used in this function are described here. Refer to 2.9 Parameters for details on the structure.

The contents of the structure are referred and updated during communication. Do not rewrite the structure during communication (RIIC\_COMMUNICATION) and when an error has occurred (RIIC\_TMO and RIIC\_ERROR).

When setting the slave address, store it without shifting 1 bit to left.

For the parameter which has '(to be updated)' in the comment below, the argument for the parameter will be updated during the API execution.

```
riic_ch_dev_status_t dev_sts; /* Device state flag (to be updated)*/  
uint8_t ch_no; /* Channel number */  
riic_callback callbackfunc; /* Callback function */  
uint32_t cnt2nd; /* Second data counter (number of bytes)  
                (to be updated for only pattern 1 and 2) */  
uint32_t cnt1st; /* First data counter (number of bytes)  
                (to be updated for only pattern 1) */  
uint8_t * p_data2nd; /* Pointer to the second data storage buffer */  
uint8_t * p_data1st; /* Pointer to the first data storage buffer */  
uint8_t * p_slv_adr; /* Pointer to the slave address storage buffer */
```

#### Return Values

```
RIIC_SUCCESS /* Processing completed successfully */  
RIIC_ERR_INVALID_CHAN /* The channel is nonexistent. */  
RIIC_ERR_INVALID_ARG /* The parameter is invalid. */  
RIIC_ERR_NO_INIT /* Uninitialized state */  
RIIC_ERR_BUS_BUSY /* The bus state is busy. */  
RIIC_ERR_AL /* Arbitration-lost error occurred */  
RIIC_ERR_TMO /* Timeout is detected */  
RIIC_ERR_OTHER /* The event occurred is invalid in the current state. */
```

#### Properties

Prototyped in r\_riic\_rx\_if.h.

#### Description

Starts the RIIC master transmission. The transmission is performed with the RIIC channel and transmit pattern specified by parameters. If the state of the channel is 'idle (RIIC\_IDLE, RIIC\_FINISH, or RIIC\_NACK)', the following processes are performed.

## RX Family I<sup>2</sup>C Bus Interface (RIIC) Module Using Firmware Integration Technology

- Setting the state flag
- Initializing variables used by the API
- Enabling the RIIC interrupts
- Generating a start condition

This function returns RIIC\_SUCCESS as a return value when the processing up to the start condition generation ends normally. This function returns RIIC\_ERR\_BUS\_BUSY as a return value when the following conditions are met to the start condition generation ends normally. <sup>(1)</sup>

- The internal status bit is in busy state.
- Either SCL or SDA line is in low state.

The transmission processing is performed sequentially in subsequent interrupt processing after this function return RIIC\_SUCCESS. Section "2.4 Usage of Interrupt Vector" should be referred for the interrupt to be used. For master transmission, the interrupt generation timing should be referred from "6.2.1 Master transmission".

After issuing a stop condition at the end of transmission, the callback function specified by the argument is called.

The transmission completion is performed normally or not, can be confirmed by checking the device status flag specified by the argument or the channel status flag g\_riic\_ChStatus [], that is to be "RIIC\_FINISH" for normal completion.

### Notes:

1. When SCL and SDA pin is not external pull-up, this function may return RIIC\_ERR\_BUS\_BUSY by detecting either SCL or SDA line is as in low state.

### Example

```
/* for MasterSend(Pattern 1) */
#include <stddef.h>
#include "platform.h"
#include "r_riic_rx_if.h"

riic_info_t iic_info_m;

void CallbackMaster(void);
void main(void);

void main(void)
{
    volatile riic_return_t ret;

    uint8_t addr_eeprom[1] = {0x50};
    uint8_t access_addr1[1] = {0x00};
    uint8_t mst_send_data[5] = {0x81,0x82,0x83,0x84,0x85};

    /* Sets IIC Information for sending pattern 1. */
    iic_info_m.dev_sts = RIIC_NO_INIT;
    iic_info_m.ch_no = 0;
    iic_info_m.callbackfunc = &CallbackMaster;
    iic_info_m.cnt2nd = 3;
    iic_info_m.cnt1st = 1;
    iic_info_m.p_data2nd = mst_send_data;
    iic_info_m.p_data1st = access_addr1;
    iic_info_m.p_slv_adr = addr_eeprom;
```

```
/* RIIC open */
ret = R_RIIC_Open(&iic_info_m);

/* RIIC send start */
ret = R_RIIC_MasterSend(&iic_info_m);

if (RIIC_SUCCESS == ret)
{
    while(RIIC_FINISH != iic_info_m.dev_sts);
}
else
{
    /* error */
}

/* RIIC send complete */
while(1);
}

void CallbackMaster(void)
{
    volatile riic_return_t ret;
    riic_mcu_status_t      iic_status;

    ret = R_RIIC_GetStatus(&iic_info_m, &iic_status);
    if(RIIC_SUCCESS != ret)
    {
        /* Call error processing for the R_RIIC_GetStatus() function */
    }
    else
    {
        /* Processing when a timeout, arbitration-lost, NACK,
        or others is detected by verifying the iic_status flag. */
    }
}
}
```

## RX Family I<sup>2</sup>C Bus Interface (RIIC) Module Using Firmware Integration Technology

### Special Notes

The table below lists available settings for each pattern.

Structure Member	Available Settings for Each Pattern of the Master Transmission			
	Pattern 1	Pattern 2	Pattern 3	Pattern 4
*p_slv_adr	Pointer to the slave address storage buffer			FIT_NO_PTR <sup>(1)</sup>
*p_data1st	Pointer to the first data storage buffer for transmitting	FIT_NO_PTR <sup>(1)</sup>	FIT_NO_PTR <sup>(1)</sup>	FIT_NO_PTR <sup>(1)</sup>
*p_data2nd	Pointer to the second data storage buffer for transmitting		FIT_NO_PTR <sup>(1)</sup>	FIT_NO_PTR <sup>(1)</sup>
cnt1st	0000 0001h to FFFF FFFFh <sup>(2)</sup>	0	0	0
cnt2nd	0000 0001h to FFFF FFFFh <sup>(2)</sup>		0	0
callbackfunc	Specify the function name used			
ch_no	00h to FFh			
dev_sts	Device state flag			
rsv1, rsv2	Reserved (value set here has no effect )			

Notes:

1. When using pattern 2, 3, or 4, set 'FIT\_NO\_PTR' as the argument of the parameter.
2. 0 cannot be set.

## 3.3 R\_RIIC\_MasterReceive()

Starts master reception. Changes the receive pattern according to the parameters. Operates batched processing until stop condition generation.

### Format

```
riic_return_t R_RIIC_MasterReceive(  
    riic_info_t * p_riic_info /* Structure data */  
)
```

### Parameters

*\*p\_riic\_info*

This is the pointer to the I<sup>2</sup>C communication information structure. The receive pattern can be selected from master reception and master transmit/receive by the parameter setting. Refer to the Special Notes in this section for available settings and the setting values for each receive pattern. Also refer to 1.3.3 Master Reception for details of each receive pattern.

Only members of the structure used in this function are described here. Refer to 2.9 Parameters for details on the structure.

The contents of the structure are referred and updated during communication. Do not rewrite the structure during communication (RIIC\_COMMUNICATION) and when an error has occurred (RIIC\_TMO and RIIC\_ERROR).

When setting the slave address, store it without shifting 1 bit to left.

For the parameter which has '(to be updated)' in the comment below, the argument for the parameter will be updated during the API execution.

```
riic_ch_dev_status_t dev_sts; /* Device state flag (to be updated) */  
uint8_t ch_no; /* Channel number */  
riic_callback callbackfunc; /* Callback function */  
uint32_t cnt2nd; /* Second data counter (number of bytes) (to be updated) */  
uint32_t cnt1st; /* First data counter (number of bytes)  
                (to be updated only for master transmit/receive) */  
uint8_t * p_data2nd; /* Pointer to the second data storage buffer */  
uint8_t * p_data1st; /* Pointer to the first data storage buffer */  
uint8_t * p_slv_adr; /* Pointer to the slave address storage buffer */
```

### Return Values

```
RIIC_SUCCESS /* Processing completed successfully */  
RIIC_ERR_INVALID_CHAN /* The channel is nonexistent. */  
RIIC_ERR_INVALID_ARG /* The parameter is invalid. */  
RIIC_ERR_NO_INIT /* Uninitialized state */  
RIIC_ERR_BUS_BUSY /* The bus state is busy. */  
RIIC_ERR_AL /* Arbitration-lost error occurred */  
RIIC_ERR_TMO /* Timeout is detected */  
RIIC_ERR_OTHER /* The event occurred is invalid in the current state. */
```

### Properties

Prototyped in r\_riic\_rx\_if.h.



### Description

Starts the RIIC master reception. The reception is performed with the RIIC channel and receive pattern specified by parameters. If the state of the channel is 'idle (RIIC\_IDLE, RIIC\_FINISH, or RIIC\_NACK)', the following processes are performed.

- Setting the state flag
- Initializing variables used by the API
- Enabling the RIIC interrupts
- Generating a start condition

This function returns RIIC\_SUCCESS as a return value when the processing up to the start condition generation ends normally. This function returns RIIC\_ERR\_BUS\_BUSY as a return value when the following conditions are met to the start condition generation ends normally. <sup>(1)</sup>

- The internal status bit is in busy state.
- Either SCL or SDA line is in low state.

The reception processing is performed sequentially in subsequent interrupt processing after this function return RIIC\_SUCCESS. Section "2.4 Usage of Interrupt Vector" should be referred for the interrupt to be used. For master transmission, the interrupt generation timing should be referred from "6.2.2 Master Reception".

After issuing a stop condition at the end of reception, the callback function specified by the argument is called.

The reception completion is performed normally or not, can be confirmed by checking the device status flag specified by the argument or the channel status flag g\_riic\_ChStatus [], that is to be "RIIC\_FINISH" for normal completion.

### Notes:

1. When SCL and SDA pin is not external pull-up, this function may return RIIC\_ERR\_BUS\_BUSY by detecting either SCL or SDA line is as in low state.

### Example

```
#include <stddef.h>
#include "platform.h"
#include "r_riic_rx_if.h"

riic_info_t    iic_info_m;

void CallbackMaster(void);
void main(void);

void main(void)
{
    volatile riic_return_t ret;

    uint8_t addr_eeprom[1]    = {0x50};
    uint8_t access_addr1[1]   = {0x00};
    uint8_t mst_store_area[5] = {0xFF, 0xFF, 0xFF, 0xFF, 0xFF};

    /* Sets IIC Information. */
    iic_info_m.dev_sts = RIIC_NO_INIT;
    iic_info_m.ch_no = 0;
    iic_info_m.callbackfunc = &CallbackMaster;
    iic_info_m.cnt2nd = 3;
```

## **RX Family I<sup>2</sup>C Bus Interface (RIIC) Module Using Firmware Integration Technology**

```
iic_info_m.cnt1st = 1;
iic_info_m.p_data2nd = mst_store_area;
iic_info_m.p_data1st = access_addr1;
iic_info_m.p_slv_adr = addr_eeeprom;

/* RIIC open */
ret = R_RIIC_Open(&iic_info_m);

/* RIIC receive start */
ret = R_RIIC_MasterReceive(&iic_info_m);

if (RIIC_SUCCESS == ret)
{
    while(RIIC_FINISH != iic_info_m.dev_sts);
}
else
{
    /* error */
}

/* RIIC receive complete */
while(1);
}

void CallbackMaster(void)
{
    volatile riic_return_t ret;
    riic_mcu_status_t      iic_status;

    ret = R_RIIC_GetStatus(&iic_info_m, &iic_status);
    if(RIIC_SUCCESS != ret)
    {
        /* Call error processing for the R_RIIC_GetStatus() function */
    }
    else
    {
        /* Processing when a timeout, arbitration-lost, NACK,
        or others is detected by verifying the iic_status flag.*/
    }
}
}
```

## RX Family I<sup>2</sup>C Bus Interface (RIIC) Module Using Firmware Integration Technology

### Special Notes

The table below lists available settings for each receive pattern.

Structure Member	Available Settings for Each Pattern of the Master Reception	
	Master Reception	Master transmit/receive
*p_slv_adr	Pointer to the slave address storage buffer	
*p_data1st	Not used (value set here has no effect)	Pointer to the first data storage buffer for transmitting
*p_data2nd	Pointer to the second data storage buffer for receiving	
dev_sts	Device state flag	
cnt1st <sup>(1)</sup>	0	0000 0001h to FFFF FFFFh
cnt2nd	0000 0001h to FFFF FFFFh <sup>(2)</sup>	
callbackfunc	Specify the function name used	
ch_no	00h to FFh	
rsv1, rsv2	Reserved (value set here has no effect)	

Notes:

1. The receive pattern is determined by whether cnt1st is 0 or not.
2. 0 cannot be set.

## 3.4 R\_RIIC\_SlaveTransfer()

This function performs slave transmission and reception. Changes the transmit and receive pattern according to the parameters.

### Format

```
riic_return_t R_RIIC_SlaveTransfer(
    riic_info_t * p_riic_info    /* Structure data */
)
```

### Parameters

*\*p\_riic\_info*

This is the pointer to the I<sup>2</sup>C communication information structure. The operation can be selected from preparation for slave reception, slave transmission, or both of them by the parameter setting. Refer to the Special Notes in this section for available parameter settings. Also refer to 1.3.4 Slave Transmission and Reception for details of slave operations.

Only members of the structure used in this function are described here. Refer to 2.9 Parameters for details on the structure.

The contents of the structure are referred and updated during communication. Do not rewrite the structure during communication (RIIC\_COMMUNICATION) and when an error has occurred (RIIC\_TMO and RIIC\_ERROR).

For the parameter which has '(to be updated)' in the comment below, the argument for the parameter will be updated during the API execution.

```
riic_ch_dev_status_t dev_sts; /* Device state flag (to be updated)*/
uint8_t ch_no; /* Channel number */
riic_callback callbackfunc; /* Callback function */
uint32_t cnt2nd; /* Second data counter (number of bytes)
                 (to be updated for only slave reception) */
uint32_t cnt1st; /* First data counter (number of bytes)
                 (to be updated for only slave transmission) */
uint8_t * p_data2nd; /* Pointer to the second data storage buffer */
uint8_t * p_data1st; /* Pointer to the first data storage buffer */
```

### Return Values

```
RIIC_SUCCESS /* Processing completed successfully */
RIIC_ERR_INVALID_CHAN /* The channel is nonexistent. */
RIIC_ERR_INVALID_ARG /* The parameter is invalid. */
RIIC_ERR_NO_INIT /* Uninitialized state */
RIIC_ERR_BUS_BUSY /* The bus state is busy. */
RIIC_ERR_AL /* Arbitration-lost error occurred */
RIIC_ERR_TMO /* Timeout is detected */
RIIC_ERR_OTHER /* The event occurred is invalid in the current state. */
```

### Properties

Prototyped in r\_riic\_rx\_if.h.

### Description

Prepares for the RIIC slave transmission or slave reception. If this function is called while the master is communicating, an error occurs. Sets the RIIC channel specified by the parameter. If the state of the channel is 'idle (RIIC\_IDLE, RIIC\_FINISH, or RIIC\_NACK)', the following processes are performed.

- Setting the state flag
- Initializing variables used by the API
- Initializing the RIIC registers used for the RIIC communication
- Enabling the RIIC interrupts
- Setting the slave address and enabling the slave address match interrupt

This function returns RIIC\_SUCCESS as a return value when the setting of slave address and permission of slave address match interrupt are completed normally.

The processing of slave transmission or slave reception is performed sequentially in the subsequent interrupt processing.

Section "2.4 Usage of Interrupt Vector" should be referred for the interrupt to be used.

The interrupt generation timing of slave transmission should be referred from "6.2.4 Slave Transmission". The interrupt generation timing for slave reception should be referred from "6.2.5 Slave reception".

After detecting the stop condition of slave transmission or slave reception termination, the callback function specified by the argument is called.

The successful completion of slave reception can be checked by confirming the device status flag or channel status flag specified in the argument g\_riic\_ChStatus [], that is to be "RIIC\_FINISH". The successful completion of slave transmission can be checked by confirming the device status flag or channel status flag specified in the argument g\_riic\_ChStatus [], that is to be "RIIC\_FINISH" or "RIIC\_NACK". "RIIC\_NACK" is set when master device transmitted NACK for notify to the slave that last data receive completed.

### Example

```
#include <stddef.h>
#include "platform.h"
#include "r_riic_rx_if.h"

riic_info_t    iic_info_m;

void CallbackMaster(void);
void CallbackSlave(void);
void main(void);

void main(void)
{
    volatile    riic_return_t ret;
    riic_info_t iic_info_s;

    uint8_t addr_eeeprom[1]    = {0x50};
    uint8_t access_addr1[1]    = {0x00};
    uint8_t mst_send_data[5]    = {0x81,0x82,0x83,0x84,0x85};
    uint8_t slv_send_data[5]    = {0x71,0x72,0x73,0x74,0x75};
    uint8_t mst_store_area[5]   = {0xFF,0xFF,0xFF,0xFF,0xFF};
    uint8_t slv_store_area[5]   = {0xFF,0xFF,0xFF,0xFF,0xFF};

    /* Sets IIC Information for Master Send. */
    iic_info_m.dev_sts = RIIC_NO_INIT;
```

## **RX Family I<sup>2</sup>C Bus Interface (RIIC) Module Using Firmware Integration Technology**

```
iic_info_m.ch_no = 0;
iic_info_m.callbackfunc = &CallbackMaster;
iic_info_m.cnt2nd = 3;
iic_info_m.cnt1st = 1;
iic_info_m.p_data2nd = mst_store_area;
iic_info_m.p_data1st = access_addr1;
iic_info_m.p_slv_adr = addr_eeeprom;

/* Sets IIC Information for Slave Transfer. */
iic_info_s.dev_sts = RIIC_NO_INIT;
iic_info_s.ch_no = 0;
iic_info_s.callbackfunc = &CallbackSlave;
iic_info_s.cnt2nd = 3;
iic_info_s.cnt1st = 3;
iic_info_s.p_data2nd = slv_store_area;
iic_info_s.p_data1st = slv_send_data;
iic_info_s.p_slv_adr = (uint8_t*)FIT_NO_PTR;

/* RIIC open */
ret = R_RIIC_Open(&iic_info_m);

/* RIIC slave transfer enable */
ret = R_RIIC_SlaveTransfer(&iic_info_s);

/* RIIC master send start */
ret = R_RIIC_MasterSend(&iic_info_m);

while(1);
}

void CallbackMaster(void)
{
    volatile riic_return_t ret;
    riic_mcu_status_t      iic_status;

    ret = R_RIIC_GetStatus(&iic_info_m, &iic_status);
    if(RIIC_SUCCESS != ret)
    {
        /* Call error processing for the R_RIIC_GetStatus() function */
    }
    else
    {
        /* Processing when a timeout, arbitration-lost, NACK,
        or others is detected by verifying the iic_status flag.*/
    }
}

void CallbackSlave(void)
{
    /* Processing when an event occurs in slave mode as required. */
}
```

## RX Family I<sup>2</sup>C Bus Interface (RIIC) Module Using Firmware Integration Technology

### Special Notes

The table below lists available settings for each receive pattern.

Structure Member	Available Parameter Settings	
	Slave Reception	Slave Transmission
*p_slv_adr	Not used (value set here has no effect)	
*p_data1st	(For slave transmission)	Pointer to the first data storage buffer for transmitting <sup>(1)</sup>
*p_data2nd	Pointer to the second data storage buffer for receiving <sup>(2)</sup>	(For slave reception)
dev_sts	Device state flag	
cnt1st	(For slave transmission)	0000 0001h to FFFF FFFFh
cnt2nd	0000 0001h to FFFF FFFFh	(For slave reception)
callbackfunc	Specify the function name used	
ch_no	00h to FFh	
rsv1, rsv2	Reserved (value set here has no effect)	

Notes:

1. Set this when performing slave transmission.  
When slave transmission is not used in the user system, set FIT\_NO\_PTR.
2. Set this when performing slave reception.  
When slave reception is not used in the user system, set FIT\_NO\_PTR.

## 3.5 R\_RIIC\_GetStatus()

Returns the state of this module.

### Format

```
riic_sts_flg_t R_RIIC_GetStatus(
    riic_info_t* p_riic_info /* Structure data */
    riic_mcu_status_t* p_riic_status /* RIIC state */
)
```

### Parameters

*\*p\_riic\_info*

This is the pointer to the I<sup>2</sup>C communication information structure.

Only the member of the structure used in this function is described here. Refer to 2.9 Parameters for details on the structure.

For the parameter which has '(to be updated)' in the comment below, the argument for the parameter will be updated during the API execution.

```
riic_ch_dev_status_t dev_sts; /* Device state flag
                               (to be updated when the state is "RIIC_AL")*/
uint8_t ch_no; /* Channel number */
```

*\*p\_riic\_status*

This contains the variable to store the RIIC state. Use the structure members listed below to specify parameters.

```
typedef union
{
    uint32_t LONG;
    struct
    {
        uint32_t rsv:19; /* reserve */
        uint32_t TMO:1; /* Timeout flag */
        uint32_t AL:1; /* Arbitration lost detection flag */
        uint32_t rsv:4; /* reserve */
        uint32_t SCLO:1; /* SCL pin output control status */
        uint32_t SDAO:1; /* SDA pin output control status */
        uint32_t SCLI:1; /* SCL pin level */
        uint32_t SDAI:1; /* SDA pin level */
        uint32_t NACK:1; /* NACK detection flag */
        uint32_t rsv:1; /* reserve */
        uint32_t BSY:1; /* Bus status flag */
    }BIT;
} riic_mcu_status_t;
```

### Return Values

*RIIC\_SUCCESS* /\* Processing completed successfully \*/

*RIIC\_ERR\_INVALID\_CHAN* /\* The channel is nonexistent. \*/

*RIIC\_ERR\_INVALID\_ARG* /\* The parameter is invalid. \*/



**Properties**

Prototyped in r\_riic\_rx\_if.h.

**Description**

Returns the state of this module.

By reading the register, pin level, variable, or others, obtains the state of the RIIC channel which specified by the parameter, and returns the obtained state as 32-bit structure.

When this function is called, the RIIC arbitration-lost flag and NACK flag are cleared to 0. If the device state is "RIIC\_AL", the value is updated to "RIIC\_FINISH".

**Example**

```
volatile riic_return_t ret;
riic_info_t iic_info_m;
riic_mcu_status_t riic_status;

iic_info_m.ch_no = 0;

ret = R_RIIC_GetStatus(&iic_info_m, &riic_status);
```

**Special Notes**

The following shows the state flag allocation.

b31 to b16
Reserved
Reserved
Rsv
Undefined

b15 to b13	b12	b11	b10 to b8
Reserved	Event detection		Reserved
Reserved	Timeout detection	Arbitration lost detection	Reserved
Rsv	TMO	AL	Rsv
Undefined	0: Not detected 1: Detected		Undefined

b7	b6	b5	b4	b3	b2	b1	b0
Reserved	Pin status		Pin level		Event detection	Reserved	Bus state
Reserved	SCL pin control	SDA pin control	SCL pin level	SDA pin level	NACK detection	Reserved	Bus busy/ready
rsv	SCLO	SDAO	SCLI	SDAI	NACK	rsv	BSY
Undefined	0: Output low level 1: Output Hi-Z		0: Low level 1: High level		0: Not detected 1: Detected	Undefined	0: Idle 1: Busy

## 3.6 R\_RIIC\_Control()

This function outputs conditions, Hi-Z from the SDA, and one-shot of the SCL clock. Also it resets the settings of this module. This function is mainly used when a communication error occurs.

### Format

```
riic_return_t R_RIIC_Control(  
    r_riic_info_t * p_riic_info    /* Structure data */  
    uint8_t ctrl_ptn              /* Output pattern */  
);
```

### Parameters

#### *\*p\_riic\_info*

This is the pointer to the I<sup>2</sup>C communication information structure.

Only the member of the structure used in this function is described here. Refer to 2.9 Parameters for details on the structure.

The contents of the structure are referred and updated during communication. Do not rewrite the structure during communication (RIIC\_COMMUNICATION) and when an error has occurred (RIIC\_TMO and RIIC\_ERROR).

For the parameter which has '(to be updated)' in the comment below, the argument for the parameter will be updated during the API execution.

```
riic_ch_dev_status_t dev_sts; /* Device state flag  
                               (to be updated when "RIIC_GEN_RESET" is  
                               specified as the output pattern) */  
uint8_t ch_no; /* Channel number */
```

#### *ctrl\_ptn*

Specifies the output pattern.

The output pattern listed below can be specified simultaneously. When specifying multiple patterns simultaneously, specify them with '|'(OR).

The following output patterns can be specified simultaneously with a combination of two or three of them.

- RIIC\_GEN\_START\_CON
- RIIC\_GEN\_RESTART\_CON
- RIIC\_GEN\_STOP\_CON

The following two can be specified simultaneously.

- RIIC\_GEN\_SDA\_HI\_Z
- RIIC\_GEN\_SCL\_ONESHOT

```
#define RIIC_GEN_START_CON (uint8_t)(0x01) /* Start condition generation */  
#define RIIC_GEN_STOP_CON (uint8_t)(0x02) /* Stop condition generation */  
#define RIIC_GEN_RESTART_CON (uint8_t)(0x04) /* Restart condition generation */  
#define RIIC_GEN_SDA_HI_Z (uint8_t)(0x08) /* Hi-Z output from the SDA pin */  
#define RIIC_GEN_SCL_ONESHOT (uint8_t)(0x10) /* SCL clock one-shot output */  
#define RIIC_GEN_RESET (uint8_t)(0x20) /* RIIC module reset */
```

### **Return Values**

*RIIC\_SUCCESS* /\* Processing completed successfully \*/  
*RIIC\_ERR\_INVALID\_CHAN* /\* Nonexistent channel \*/  
*RIIC\_ERR\_INVALID\_ARG* /\* Invalid parameter \*/  
*RIIC\_ERR\_BUS\_BUSY* /\* Bus is busy \*/  
*RIIC\_ERR\_AL* /\* Arbitration-lost error occurred \*/  
*RIIC\_ERR\_OTHER* /\* The event occurred is invalid in the current state. \*/

### **Properties**

Prototyped in `r_riic_rx_if.h`.

### **Description**

Outputs control signals of the RIIC. Outputs conditions specified by the argument, Hi-Z from the SDA pin, and one-shot of the SCL clock. Also resets the RIIC module settings.

### **Example**

```
/* Outputs an extra SCL clock cycle after the SDA pin state is changed to a high-impedance state. */  
volatile riic_return_t ret;  
riic_info_t iic_info_m;  
  
iic_info_m.ch_no = 0;  
  
ret = R_RIIC_Control(&iic_info_m, RIIC_GEN_SDA_HI_Z | RIIC_GEN_SCL_ONESHOT);
```

### **Special Notes**

#### One-shot output of the SCL clock

In master mode, if the clock signals from the master and slave devices go out of synchronization due to noise or other factors, the slave device may hold the SDA line low (bus hang up). Then the SDA line can be released from being held low by outputting one clock of the SCL at a time.

In this module, one clock of the SCL can be output by setting the output pattern "RIIC\_GEN\_SCL\_ONESHOT" (one-shot output of the SCL clock) and calling `R_RIIC_Control()`.

## 3.7 R\_RIIC\_Close()

This function completes the RIIC communication and releases the RIIC used.

### Format

```
riic_return_t R_RIIC_Close(  
    riic_info_t* p_riic_info /* Structure data */  
)
```

### Parameters

*\*p\_riic\_info*

This is the pointer to the I<sup>2</sup>C communication information structure.

Only the member of the structure used in this function is described here. Refer to 2.9 Parameters for details on the structure.

The contents of the structure are referred and updated during communication. Do not rewrite the structure during communication (RIIC\_COMMUNICATION) and when an error has occurred (RIIC\_TMO and RIIC\_ERROR).

For the parameter which has '(to be updated)' in the comment below, the argument for the parameter will be updated during the API execution.

```
riic_ch_dev_status_t dev_sts; /* Device state flag (to be updated) */  
uint8_t ch_no; /* Channel number */
```

### Return Values

```
RIIC_SUCCESS /* Processing completed successfully */  
RIIC_ERR_INVALID_CHAN /* The channel is nonexistent. */  
RIIC_ERR_INVALID_ARG /* Invalid parameter */
```

### Properties

Prototyped in r\_riic\_rx\_if.h.

### Description

Configures the settings to complete the RIIC communication. Disables the RIIC channel specified by the parameter. The following processes are performed in this function.

- Entering the RIIC module-stop state
- Releasing I<sup>2</sup>C output ports
- Disabling the RIIC interrupt

To restart the communication, call the R\_RIIC\_Open() function (initialization function). If the communication is forcibly terminated, that communication is not guaranteed.

### Example

```
volatile riic_return_t ret;  
riic_info_t iic_info_m;  
  
iic_info_m.ch_no = 0;  
  
ret = R_RIIC_Close(&iic_info_m);
```

**Special Notes**

None

---

### **3.8 R\_RIIC\_GetVersion()**

---

Returns the current version of this module.

#### **Format**

uint32\_t R\_RIIC\_GetVersion(void)

#### **Parameters**

*None*

#### **Return Values**

*Version number*

#### **Properties**

Prototyped in r\_riic\_rx\_if.h.

#### **Description**

This function will return the version of the currently installed RIIC FIT module. The version number is encoded where the top 2 bytes are the major version number and the bottom 2 bytes are the minor version number. For example, Version 4.25 would be returned as 0x00040019.

#### **Example**

```
uint32_t    version;  
  
version = R_RIIC_GetVersion();
```

#### **Special Notes**

None.

## 4. Pin Settings

To use the RIIC FIT module, assign input/output signals of the peripheral function to pins with the multi-function pin controller (MPC). The pin assignment is referred to as the “Pin Setting” in this document.

The RIIC FIT module can choose whether or not to perform the pin setting in the R\_RIIC\_Open function depending on the setting of the configuration option RIIC\_CFG\_PORT\_SET\_PROCESSING.

For details of the configuration options, refer to "2.7 Configuration Overview".

When performing the Pin Setting in the e<sup>2</sup> studio, the Pin Setting feature of the FIT Configurator or the Smart Configurator can be used. When using the pin setting feature, pins selected in the Pin Setting pane can be used in the FIT Configurator or Smart Configurator. The information of selected pins is reflected in the r\_riic\_pin\_config.h file. Values of the macro definitions listed in Table 4.1 are overwritten with values corresponding to the pins selected. When using the pin setting feature of the FIT Configurator, the source file which has the function to enable the pin setting feature (and the "r\_pincfg" folder) is not generated in the RIIC FIT module.

**Table 4.1 Macro Definitions for the Pin Setting Feature**

Channel Selected	Pin Selected	Macro Definition
Channel 0	SCL0 Pin	R_RIIC_CFG_RIIC0_SCL0_PORT R_RIIC_CFG_RIIC0_SCL0_BIT
	SDA0 Pin	R_RIIC_CFG_RIIC0_SDA0_PORT R_RIIC_CFG_RIIC0_SDA0_BIT
Channel 1	SCL1 Pin	R_RIIC_CFG_RIIC1_SCL1_PORT R_RIIC_CFG_RIIC1_SCL1_BIT
	SDA1 Pin	R_RIIC_CFG_RIIC1_SDA1_PORT R_RIIC_CFG_RIIC1_SDA1_BIT
Channel 2	SCL2 Pin	R_RIIC_CFG_RIIC2_SCL2_PORT R_RIIC_CFG_RIIC2_SCL2_BIT
	SDA2 Pin	R_RIIC_CFG_RIIC2_SDA2_PORT R_RIIC_CFG_RIIC2_SDA2_BIT

Pins selected in the r\_riic\_pin\_config.h file are configured as peripheral function pins SCL and SDA after calling the R\_RIIC\_Open function.

The pins assigned to the peripheral function are released upon calling the R\_RIIC\_Close function and then become general I/O pins (as input pins).

Pins SCL and SDA must be pulled up with an external resistor.

When the pin setting feature in this FIT module is not used according to the RIIC\_CFG\_PORT\_SET\_PROCESSING setting, pins used in user processing must be configured after calling the R\_RIIC\_Open function before calling the other APIs.

### **5. Demo Projects**

Demo projects are complete stand-alone programs. They include function main() that utilizes the module and its dependent modules (e.g.. r\_bsp).

In this section, it explains about GUI operation when you use e<sup>2</sup> studio.

---

#### **5.1 riic\_mastersend\_demo\_rskrx64m**

---

##### **Description**

A simple demo of the RX64M RIIC Master Transmission for the RSKRX64M starter kit (FIT module "r\_riic\_rx"). The demo uses the RIIC API from r\_riic\_rx\_if.h to start master transmission. The master device (RX MCU) transmits data to the slave device. When the master transmission is finished, print the finished message to the debug console by main().

##### **Setup and Execution**

1. Compile and download the sample code.
2. Click 'Reset Go' to start the software. If PC stops at Main, press F8 to resume.
3. Set breakpoints and watch global variables

##### **Boards Supported**

RSKRX64M

---

#### **5.2 riic\_masterreceive\_demo\_rskrx64m**

---

##### **Description**

A simple demo of the RX64M RIIC Master Reception for the RSKRX64M starter kit (FIT module "r\_riic\_rx"). The demo uses the RIIC API from r\_riic\_rx\_if.h to start master reception. The master (RX MCU) receives data from the slave device .When the master reception is finished, print the received data to the debug console by main().

##### **Boards Supported**

RSKRX64M

---

#### **5.3 riic\_slavetransfer\_demo\_rskrx64m**

---

##### **Description**

A simple demo of the RX64M RIIC Slave Transmission and Reception for the RSKRX64M starter kit (FIT module "r\_riic\_rx"). The demo uses the RIIC API from r\_riic\_rx\_if.h to start slave transmission and reception. The slave (RX MCU) receives data transmitted from the master, or transmits data by the transmit request from the master. When the slave transmission and reception is finished, print the finished message to the debug console by main().

##### **Boards Supported**

RSKRX64M



### **5.4 riic\_mastersend\_demo\_rskrx231**

---

#### **Description**

A simple demo of the RX231 RIIC Master Transmission for the RSKRX231 starter kit (FIT module "r\_riic\_rx"). This demo is identical to the RX64M for demo above.

#### **Boards Supported**

RSKRX231

---

### **5.5 riic\_masterreceive\_demo\_rskrx231**

---

#### **Description**

A simple demo of the RX231 RIIC Master Reception for the RSKRX231 starter kit (FIT module "r\_riic\_rx"). This demo is identical to the RX64M for demo above.

#### **Boards Supported**

RSKRX231

---

### **5.6 riic\_slavetransfer\_demo\_rskrx231**

---

#### **Description**

A simple demo of the RX231 RIIC Slave Transmission and Reception for the RSKRX231 starter kit (FIT module "r\_riic\_rx"). This demo is identical to the RX64M for demo above.

#### **Boards Supported**

RSKRX231

---

### **5.7 Adding a Demo to a Workspace**

---

Demo projects are found in the FITDemos subdirectory of the distribution file for this application note. To add a demo project to a workspace, select File>Import>General>Existing Projects into Workspace, then click "Next". From the Import Projects dialog, choose the "Select archive file" radio button. "Browse" to the FITDemos subdirectory, select the desired demo zip file, then click "Finish".

---

### **5.8 Downloading Demo Projects**

---

Demo projects are not included in the RX Driver Package. When using the demo project, the FIT module needs to be downloaded. To download the FIT module, right click on the required application note and select "Sample Code (download)" from the context menu in the Smart Brower >> Application Notes tab.

## 6. Appendices

### 6.1 Communication Method

This module controls each processing such as start condition generation, slave address transmission, and others as a single protocol, and performs communication by combining these protocols.

#### 6.1.1 States for API Operation

Table 6.1 lists the States Used for Protocol Control.

**Table 6.1 States Used for Protocol Control (enum r\_riic\_api\_status\_t)**

No.	Constant Name	Description
STS0	RIIC_STS_NO_INIT	Uninitialized state
STS1	RIIC_STS_IDLE	Idle state (ready for master communication)
STS2	RIIC_STS_IDLE_EN_SLV	Idle state (ready for master/slave communication)
STS3	RIIC_STS_ST_COND_WAIT	Wait state for a start condition to be detected
STS4	RIIC_STS_SEND_SLVADR_W_WAIT	Wait state for the slave address [write] transmission to complete
STS5	RIIC_STS_SEND_SLVADR_R_WAIT	Wait state for the slave address [read] transmission to complete
STS6	RIIC_STS_SEND_DATA_WAIT	Wait state for the data transmission to complete
STS7	RIIC_STS_RECEIVE_DATA_WAIT	Wait state for the data reception to complete
STS8	RIIC_STS_SP_COND_WAIT	Wait state for a stop condition to be detected
STS9	RIIC_STS_AL	Arbitration-lost state
STS10	RIIC_STS_TMO	Timeout detection state

#### 6.1.2 Events During API Operation

Table 6.2 lists the Events Used for Protocol Control. In this module, not only interrupt but also the module function call is defined as event.

**Table 6.2 Events Used for Protocol Control (enum r\_riic\_api\_event\_t)**

No.	Event	Event Definition
EV0	RIIC_EV_INIT	R_RIIC_Open() called
EV1	RIIC_EV_EN_SLV_TRANSFER	R_RIIC_SlaveTransfer() called
EV2	RIIC_EV_GEN_START_COND	R_RIIC_MasterSend() or R_RIIC_MasterReceive() called
EV3	RIIC_EV_INT_START	EI interrupt occurred (interrupt flag: START)
EV4	RIIC_EV_INT_ADD	TEI interrupt occurred, TXI interrupt occurred <sup>(1)</sup>
EV5	RIIC_EV_INT_SEND	TEI interrupt occurred, TXI interrupt occurred <sup>(1)</sup>
EV6	RIIC_EV_INT_RECEIVE	RXI interrupt occurred
EV7	RIIC_EV_INT_STOP	EI interrupt occurred (interrupt flag: STOP)
EV8	RIIC_EV_INT_AL	EI interrupt occurred (interrupt flag: AL)
EV9	RIIC_EV_INT_NACK	EI interrupt occurred (interrupt flag: NACK)
EV10	RIIC_EV_INT_TMO	EI interrupt occurred (interrupt flag: TMO)

Note:

- The definition of EV4 and EV5 differs depending on the communication operation and the states of "6.1.1 States for API Operation". For details, refer to "6.1.3 Protocol State Transitions".

**6.1.3 Protocol State Transitions**

In this module, a state transition occurs when an interface function provided is called or when an I<sup>2</sup>C interrupt request is generated. Figure 6.1 to Figure 6.4 show protocol state transitions.

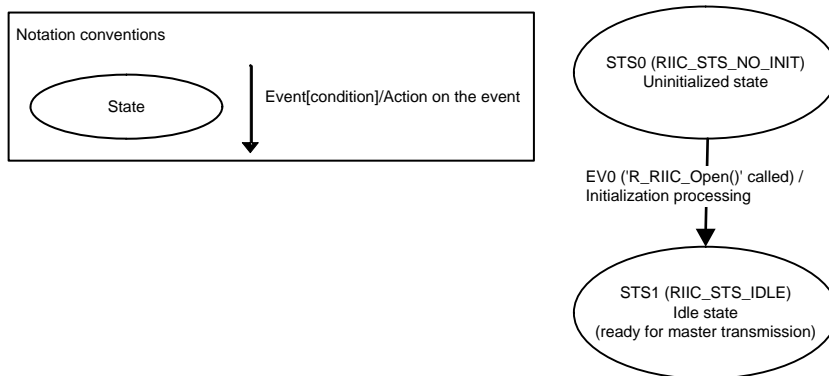

**Figure 6.1 State Transition on Initialization ('R\_RIIC\_Open()') Called**

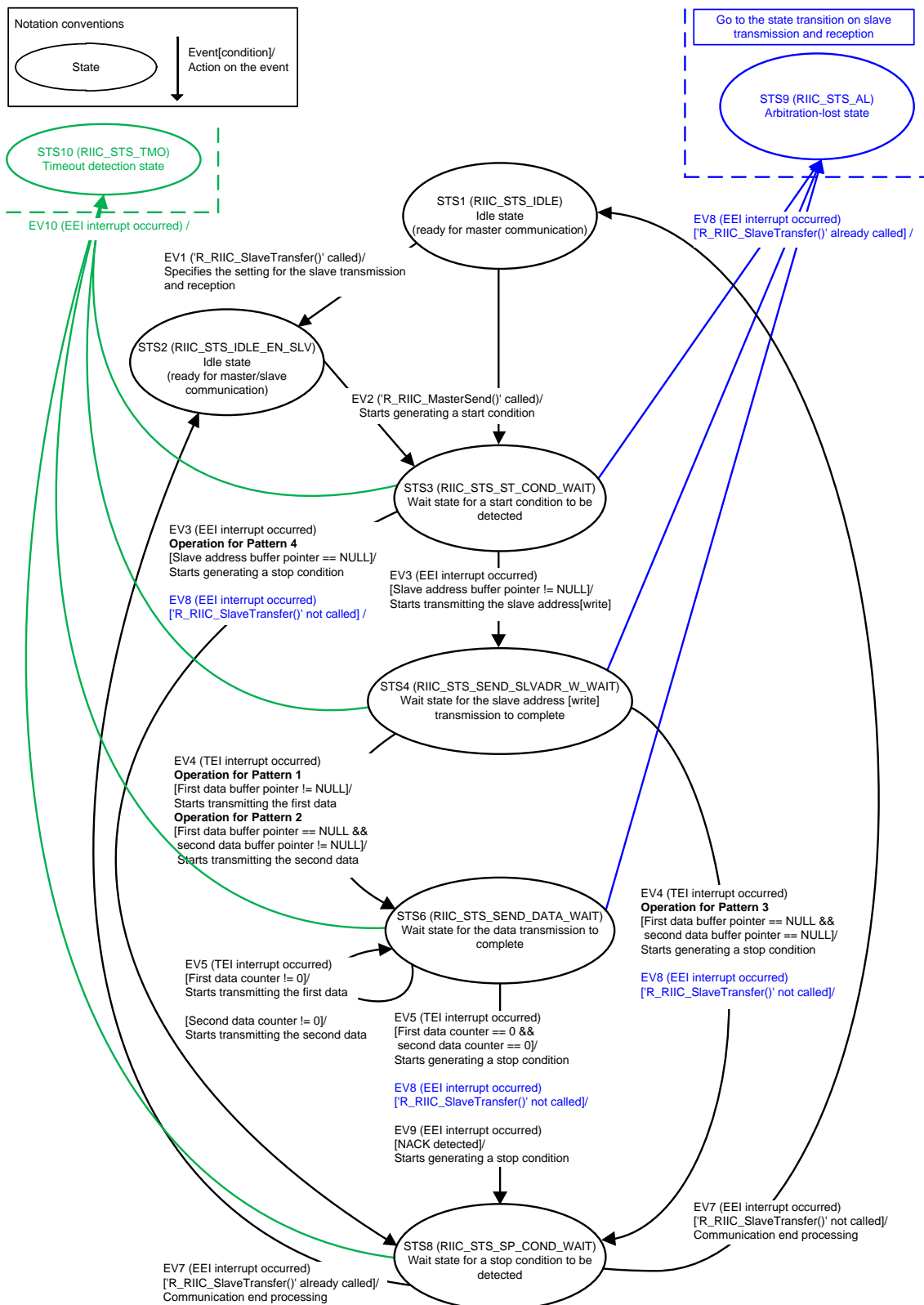

Figure 6.2 State Transition on Master Transmission (R\_RIIC\_MasterSend() Called)

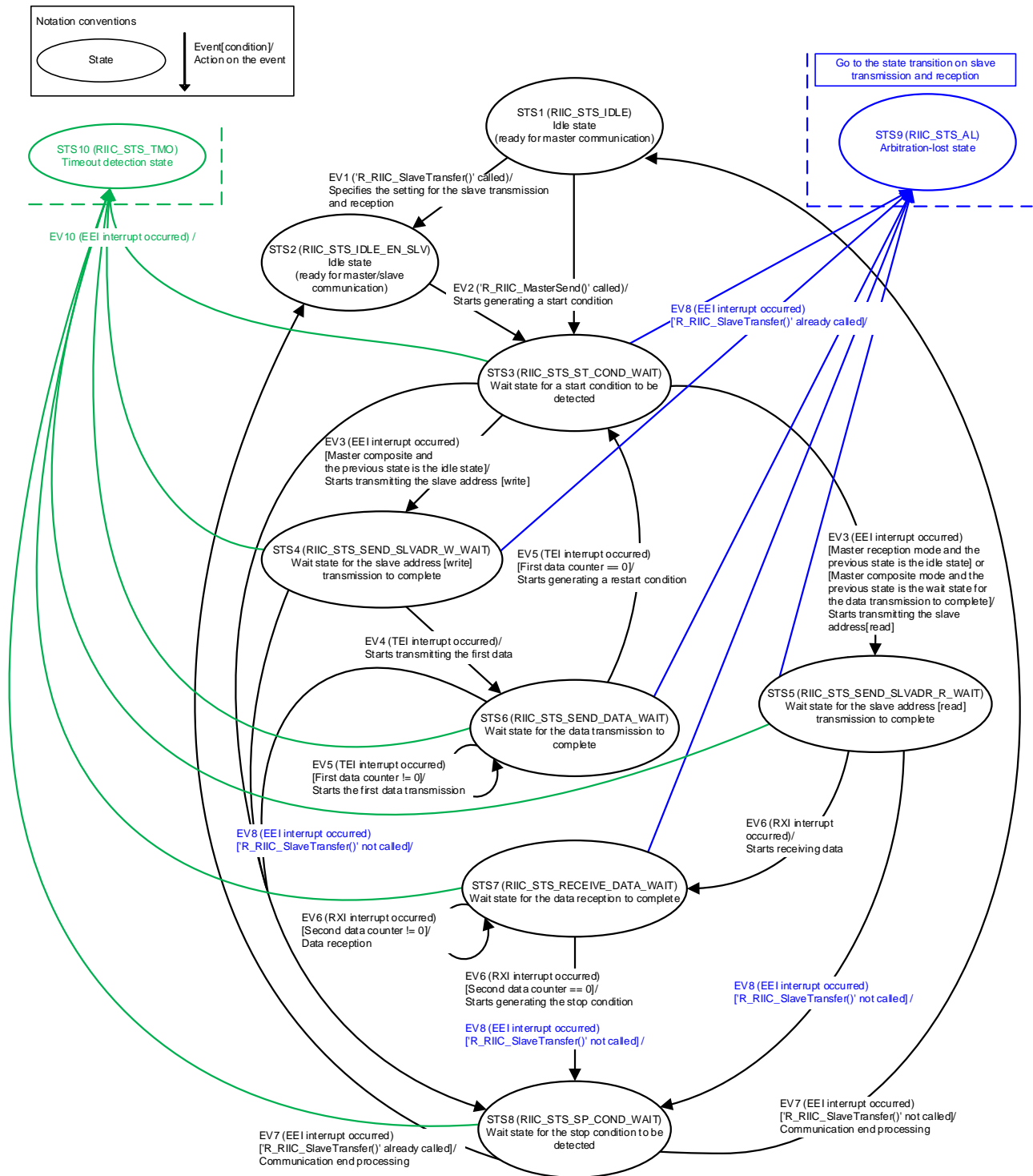

Figure 6.3 State Transition on Master Reception (R\_RIIC\_MasterReceive() Called)

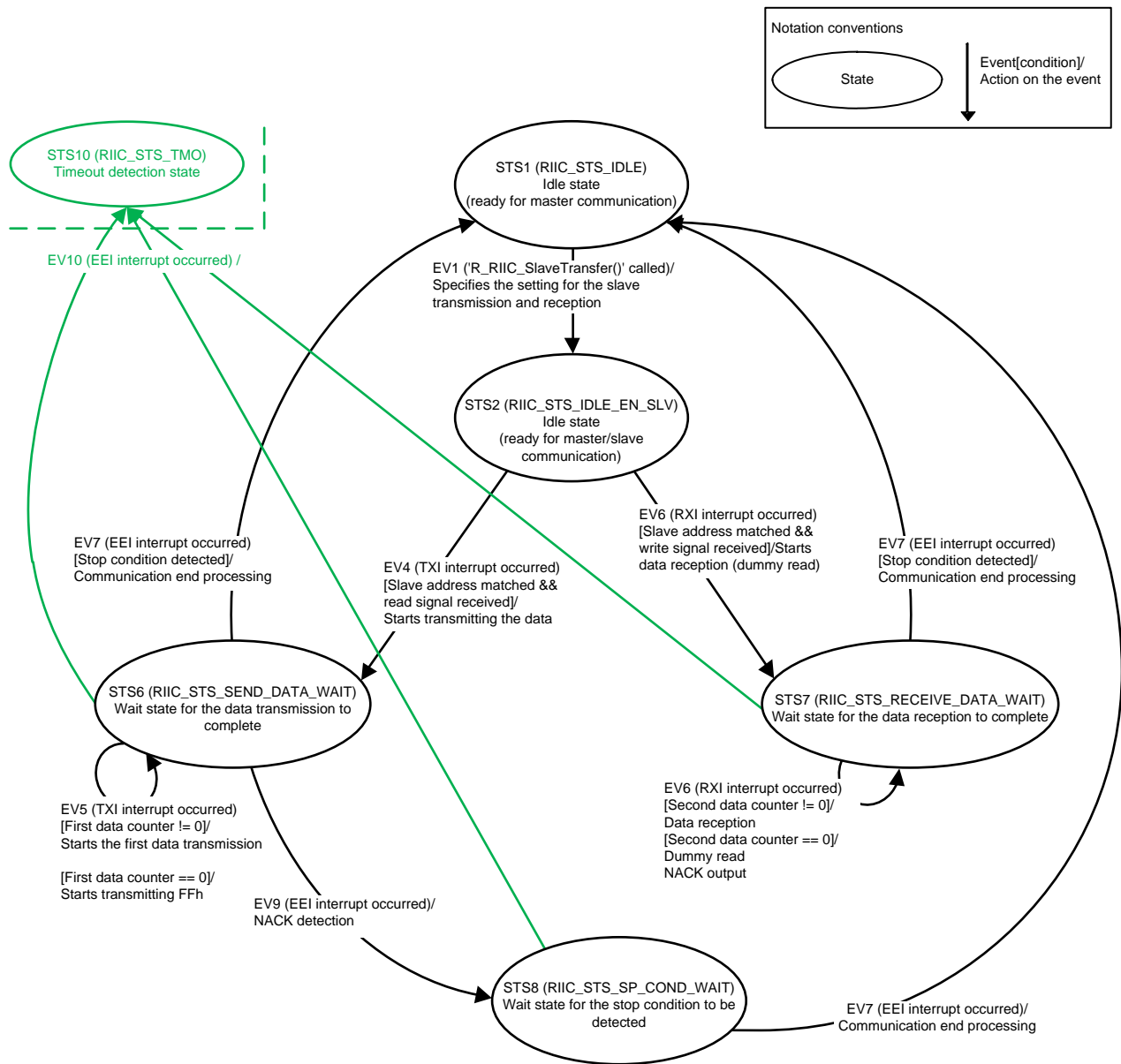

Figure 6.4 State Transition on Slave Transmission and Reception (R\_RIIC\_SlaveTransfer() Called)

**6.1.4 Protocol State Transition Table**

The processing when the events in Table 6.2 occur in the states in Table 6.1 is shown in the Table 6.3 Protocol State Transition. Refer to Table 6.4 for details of each function.

**Table 6.3 Protocol State Transition Table (gc\_riic\_mtx\_tbi[[]]) <sup>(1)</sup>**

State		Event										
		EV0	EV1	EV2	EV3	EV4	EV5	EV6	EV7	EV8	EV9	EV10
STS0	Uninitialized state [RIIC_STS_NO_INIT]	Func0	ERR	ERR	ERR	ERR	ERR	ERR	ERR	ERR	ERR	ERR
STS1	Idle state (ready for master communication) [RIIC_STS_IDLE]	ERR	Func10	Func1	ERR	ERR	ERR	ERR	ERR	ERR	ERR	ERR
STS2	Idle state (ready for master/slave communication) [RIIC_STS_IDLE_EN_SLV]	ERR	ERR	Func1	ERR	Func4	ERR	Func4	ERR	ERR	ERR	ERR
STS3	Wait state for the start condition to be generated [RIIC_STS_ST_COND_WAIT]	ERR	ERR	ERR	Func2	ERR	ERR	ERR	ERR	Func8	Func9	Func11
STS4	Wait state for the slave address [write] to complete [RIIC_STS_SEND_SLVADR_W_WAIT]	ERR	ERR	ERR	ERR	Func3	ERR	ERR	ERR	Func8	Func9	Func11
STS5	Wait state for the slave address [read] to complete [RIIC_STS_SEND_SLVADR_R_WAIT]	ERR	ERR	ERR	ERR	ERR	ERR	Func3	ERR	Func8	Func9	Func11
STS6	Wait state for the data transmission to complete [RIIC_STS_SEND_DATA_WAIT]	ERR	ERR	ERR	ERR	ERR	Func5	ERR	ERR	Func8	Func9	Func11
STS7	Wait state for the data reception to complete [RIIC_STS_RECEIVE_DATA_WAIT]	ERR	ERR	ERR	ERR	ERR	ERR	Func6	ERR	Func8	Func9	Func11
STS8	Wait state for the stop condition to be generated [RIIC_STS_SP_COND_WAIT]	ERR	ERR	ERR	ERR	ERR	ERR	ERR	Func7	ERR	Func9	Func11
STS9	Arbitration-lost state [RIIC_STS_AL]	ERR	ERR	ERR	ERR	ERR	Func5	Func6	Func7	ERR	ERR	ERR
STS10	Timeout detection state [RIIC_STS_TMO]	ERR	ERR	ERR	ERR	ERR	ERR	ERR	ERR	ERR	ERR	ERR

Note:

- ERR indicates RIIC\_ERR\_OTHER. When an unexpected event is notified in a state, error processing will be performed.

## 6.1.5 Functions Used on Protocol State Transitions

Table 6.4 lists the Functions Used on Protocol State Transition.

**Table 6.4 Functions Used on Protocol State Transition**

Processing	Function	Overview
Func0	riic_init_driver()	Initialization
Func1	riic_generate_start_cond()	Start condition generation (for master transmission)
Func2	riic_after_gen_start_cond()	Processing after generating a start condition
Func3	riic_after_send_slvadr()	Processing after completing the slave address transmission
Func4	riic_after_receive_slvadr()	Processing after matching the received slave address
Func5	riic_write_data_sending()	Data transmission
Func6	riic_read_data_receiving()	Data reception
Func7	riic_after_dtct_stop_cond ()	Communication end processing
Func8	riic_arbitration_lost()	Processing when detecting an arbitration-lost
Func9	riic_nack()	Processing when detecting a NACK
Func10	riic_enable_slave_transfer()	Enabling slave transmission/reception
Func11	riic_time_out()	Processing when detecting a timeout

## 6.1.6 Flag States on State Transitions

### 1. Controlling states of channels

Multiple slaves on the same bus can be exclusively controlled using the channel state flag 'g\_riic\_ChStatus[]'. Each channel has the channel state flag and the flag is controlled by the global variable. When the initialization for this module has completed and the target bus is not being used for a communication, the flag becomes 'RIIC\_IDLE/RIIC\_FINISH/RIIC\_NACK' (idle state (ready for communication)) and communication is available. When the bus is being used for communication, the flag becomes 'RIIC\_COMMUNICATION' (communicating). When communication is started, the flag is always verified. Thus, if a device is communicating on a bus, then no other device can start communicating on the same bus. Simultaneous communication can be achieved by controlling the channel state flag for each channel.

### 2. Controlling states of devices

Multiple slaves on the same channel can be controlled using the device state flag 'dev\_sts' in the I<sup>2</sup>C communication information structure. The device state flag stores the state of communication for the device.

Table 6.5 lists States of Flags on State Transitions.



**Table 6.5 States of Flags on State Transitions**

State	Channel State Flag	Device State Flag (Communication Device)	I <sup>2</sup> C Protocol Operating Mode	Current State of the Protocol Control
	g_riic_ChStatus[]	I <sup>2</sup> C Communication Information Structure dev_sts	Internal Communication Information Structure N_Mode	Internal Communication Information Structure N_status
Uninitialized state	RIIC_NO_INIT	RIIC_NO_INIT	RIIC_MODE_NONE	RIIC_STS_NO_INIT
Idle state (ready for master communication)	RIIC_IDLE	RIIC_IDLE	RIIC_MODE_NONE	RIIC_STS_IDLE
	RIIC_FINISH	RIIC_FINISH		
	RIIC_NACK	RIIC_NACK		
Idle state (ready for master/slave communication)	RIIC_IDLE	RIIC_IDLE	RIIC_MODE_S_READY	RIIC_STS_IDLE_EN_SLV
Communicating (master transmission)	RIIC_COMMUNICATION	RIIC_COMMUNICATION	RIIC_MODE_M_SEND	RIIC_STS_ST_COND_WAIT
				RIIC_STS_SEND_SLVADR_W_WAIT
				RIIC_STS_SEND_DATA_WAIT
				RIIC_STS_SP_COND_WAIT
				RIIC_STS_AL
Communicating (master reception)	RIIC_COMMUNICATION	RIIC_COMMUNICATION	RIIC_MODE_M_RECEIVE	RIIC_STS_ST_COND_WAIT
				RIIC_STS_SEND_SLVADR_R_WAIT
				RIIC_STS_RECEIVE_DATA_WAIT
				RIIC_STS_SP_COND_WAIT
				RIIC_STS_AL
Communicating (master transmit/receive)	RIIC_COMMUNICATION	RIIC_COMMUNICATION	RIIC_MODE_M_SEND_RECEIVE	RIIC_STS_ST_COND_WAIT
				RIIC_STS_SEND_SLVADR_W_WAIT
				RIIC_STS_SEND_SLVADR_R_WAIT
				RIIC_STS_SEND_DATA_WAIT
				RIIC_STS_RECEIVE_DATA_WAIT
				RIIC_STS_SP_COND_WAIT
				RIIC_STS_AL
Communicating (slave transmission)	RIIC_COMMUNICATION	RIIC_COMMUNICATION	RIIC_MODE_S_SEND	RIIC_STS_SEND_DATA_WAIT
				RIIC_STS_SP_COND_WAIT
				RIIC_STS_TMO
Communicating (slave reception)	RIIC_COMMUNICATION	RIIC_COMMUNICATION	RIIC_MODE_S_RECEIVE	RIIC_STS_RECEIVE_DATA_WAIT
				RIIC_STS_SP_COND_WAIT
				RIIC_STS_TMO
Arbitration-lost detection state	RIIC_AL	RIIC_AL	—	—
Timeout detection state	RIIC_TMO	RIIC_TMO	—	—
Error state	RIIC_ERROR	RIIC_ERROR	—	—

## 6.2 Interrupt Request Generation Timing

This section describes the interrupt request generation timings in this module.

Legend:

ST: Start condition

AD6 to AD0: Slave address

/W: Transfer direction bit: 0 (Write)

R: Transfer direction bit: 1 (Read)

/ACK: Acknowledge: 0

NACK: Acknowledge: 1

D7 to D0: Data

RST: Restart condition

SP: Stop condition

### 6.2.1 Master Transmission

(1) Pattern 1

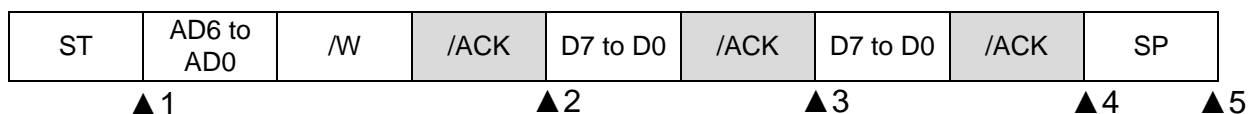

▲ 1: EEI (START) interrupt: Start condition detected

▲ 2: TEI interrupt: Address transmission completed (transfer direction bit: write)

▲ 3: TEI interrupt: Data transmission completed (first data)

▲ 4: TEI interrupt: Data transmission completed (second data)

▲ 5: EEI (STOP) interrupt: Stop condition detected

(2) Pattern 2

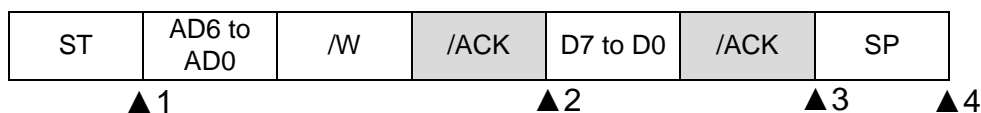

▲ 1: EEI (START) interrupt: Start condition detected

▲ 2: TEI interrupt: Address transmission completed (transfer direction bit: write)

▲ 3: TEI interrupt: Data transmission completed (second data)

▲ 4: EEI (STOP) interrupt: Stop condition detected

(3) Pattern 3

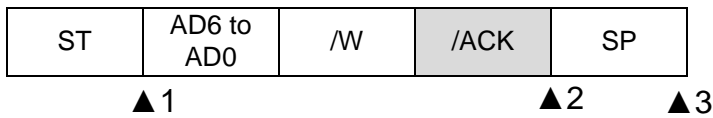

- ▲ 1: EEI (START) interrupt: Start condition detected
- ▲ 2: TEI interrupt: Address transmission completed (transfer direction bit: write)
- ▲ 3: EEI (STOP) interrupt: Stop condition detected

(4) Pattern 4

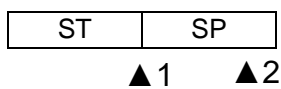

- ▲ 1: EEI (START) interrupt: Start condition detected
- ▲ 2: EEI (STOP) interrupt: Stop condition detected

Note:

1. An interrupt request is generated on the rising edge of the ninth clock.

### 6.2.2 Master Reception

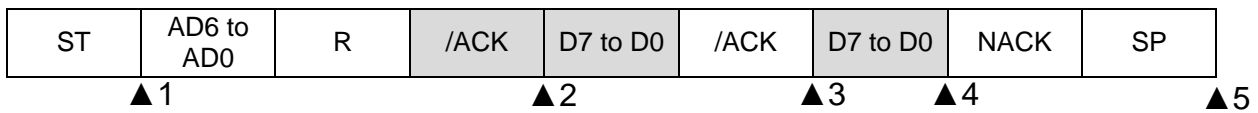

- ▲ 1: EEI (START) interrupt: Start condition detected
- ▲ 2: RXI interrupt: Address transmission completed (transfer direction bit: read)
- ▲ 3: RXI interrupt: Reception for the last data - 1 completed (second data)
- ▲ 4: RXI interrupt: Reception for the last data completed (second data)
- ▲ 5: EEI (STOP) interrupt: Stop condition detected

**6.2.3 Master Transmit/Receive**

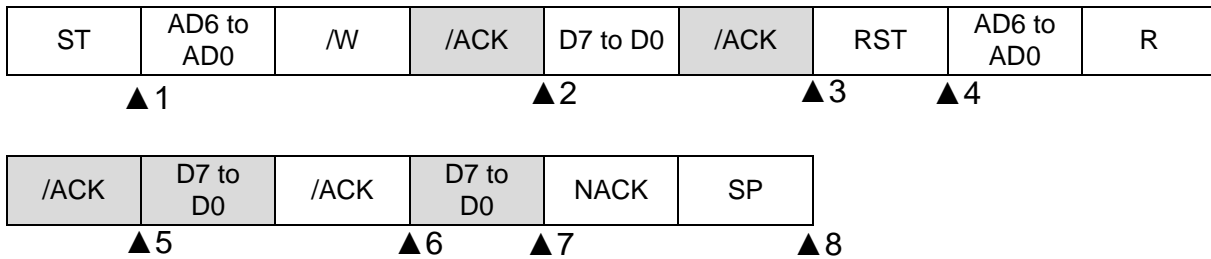

- ▲ 1: EEI (START) interrupt: Start condition detected
- ▲ 2: TEI interrupt: Address transmission completed (transfer direction bit: write)
- ▲ 3: TEI interrupt: Data transmission completed (first data)
- ▲ 4: EEI (START) interrupt: Restart condition detected
- ▲ 5: RXI interrupt: Address transmission completed (transfer direction bit: read)
- ▲ 6: RXI interrupt: Reception for the last data - 1 completed (second data)
- ▲ 7: RXI interrupt: Reception for the last data completed (second data)
- ▲ 8: EEI (STOP) interrupt: Stop condition detected

**6.2.4 Slave Transmission**

When transmitting 2-byte data:

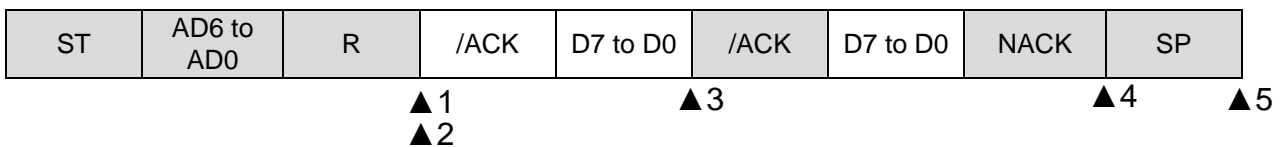

- ▲ 1: TXI interrupt: Received address matched (transfer direction bit: read)
- ▲ 2: TXI interrupt: Transmit buffer is empty
- ▲ 3: TXI interrupt: Transmit buffer is empty
- ▲ 4: EEI (NACK) interrupt: NACK detected
- ▲ 5: EEI (STOP) interrupt: Stop condition detected

## RX Family I<sup>2</sup>C Bus Interface (RIIC) Module Using Firmware Integration Technology

When transmitting 3-byte data:

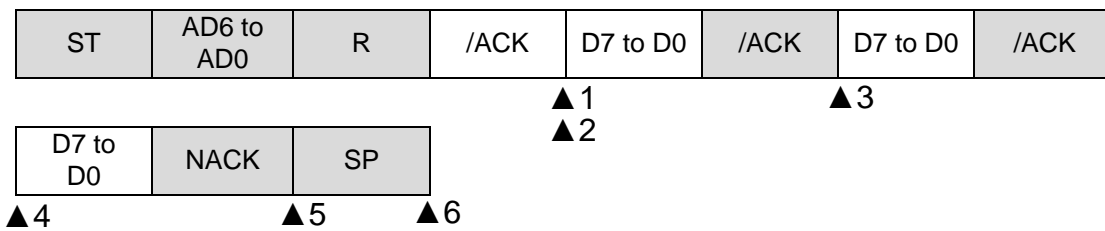

- ▲ 1: TXI interrupt: Received address matched (transfer direction bit: read)
- ▲ 2: TXI interrupt: Transmit buffer is empty
- ▲ 3: TXI interrupt: Transmit buffer is empty
- ▲ 4: TXI interrupt: Transmit buffer is empty
- ▲ 5: EEI (NACK) interrupt: NACK detected
- ▲ 6: EEI (STOP) interrupt: Stop condition detected

### 6.2.5 Slave Reception

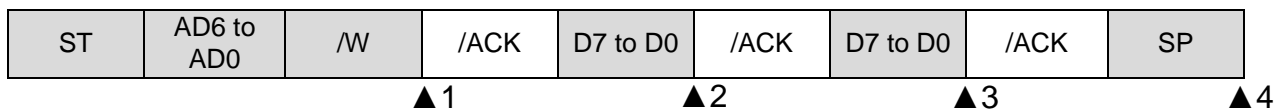

- ▲ 1: RXI interrupt: Received address matched (transfer direction bit: write)
- ▲ 2: RXI interrupt: Reception for the last data - 1 completed (second data)
- ▲ 3: RXI interrupt: Reception for the last data completed (second data)
- ▲ 4: EEI (STOP) interrupt: Stop condition detected

### 6.2.6 Multi-Master Communication

(Slave transmission after detecting AL during master transmission)

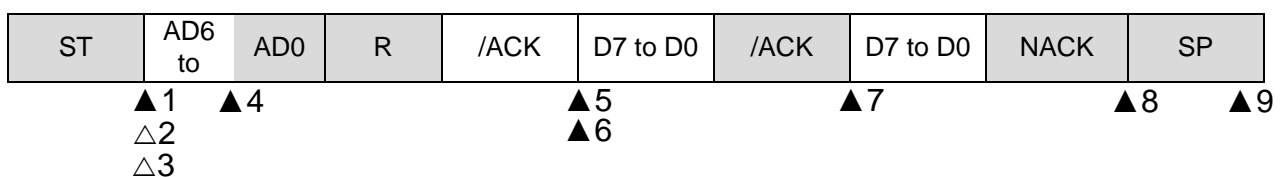

- ▲ 1: EEI (START) interrupt: Start condition detected
- △ 2: TXI interrupt: Start condition detected (no processing performed)
- △ 3: TXI interrupt: Transmit buffer is empty (no processing performed)
- ▲ 4: EEI (AL) interrupt: Arbitration-lost detected
- ▲ 5: TXI interrupt: Address reception matched (transfer direction bit: Read)
- ▲ 6: TXI interrupt: Transmit buffer is empty
- ▲ 7: TXI interrupt: Transmit buffer is empty
- ▲ 8: EEI (NACK) interrupt: NACK detected
- ▲ 9: EEI (STOP) interrupt: Stop condition detected

### **6.3 Timeout Detection and Processing After the Detection**

#### **6.3.1 Detecting a Timeout with the Timeout Detection Function**

When the timeout detection function is enabled by the setting in `r_riic_config.h`, call the `R_RIIC_GetStatus()` function in the callback function.

The information of timeout detection can be verified with the TMO bit in the `riic_mcu_status_t` structure specified as the second parameter in the `R_RIIC_GetStatus()` function.

- When the TMO bit is 1: Timeout detected
- When the TMO bit is 0: Timeout not detected

#### **6.3.2 Processing After a Timeout is Detected**

When a timeout is detected, the `R_RIIC_Close()` function needs to be called once to restart communication calling the `R_RIIC_Open()` function in the initialization.

A timeout may be detected due to a bus hang up. In master mode, if the clock signals from the master and slave devices go out of synchronization due to noise or other factors, the slave device may hold the SDA line low (bus hang up). Then the stop condition cannot be issued and a timeout will be detected.

To recover from bus hang up state, the extra SCL clock cycle output function is used. Outputting one clock of the extra SCL at a time can release the SDA line from being held low and the bus is recovered from hang up state.

To output one clock of the extra SCL clock, set "RIIC\_GEN\_SCL\_ONESHOT" (one-shot output of the SCL clock) to the second parameter of the `R_RIIC_Control()` function and call the `R_RIIC_Control()` function.

The state of the SCL pin can be verified using the `R_RIIC_GetStatus()` function.

Repeat one-shot output of the SCL clock until the SCL clock becomes high.

Figure 6.5 shows the Timeout Detection and Processing After the Detection.

For details on the extra SCL clock cycle output function, refer to the Extra SCL Clock Cycle Output Function section of the I<sup>2</sup>C Bus Interface (RIIC) chapter in the User's Manual: Hardware for the product used.

If the RX111 Group is used, refer to "27.11.2 Extra SCL Clock Cycle Output Function" in the RX111 Group User's Manual: Hardware.

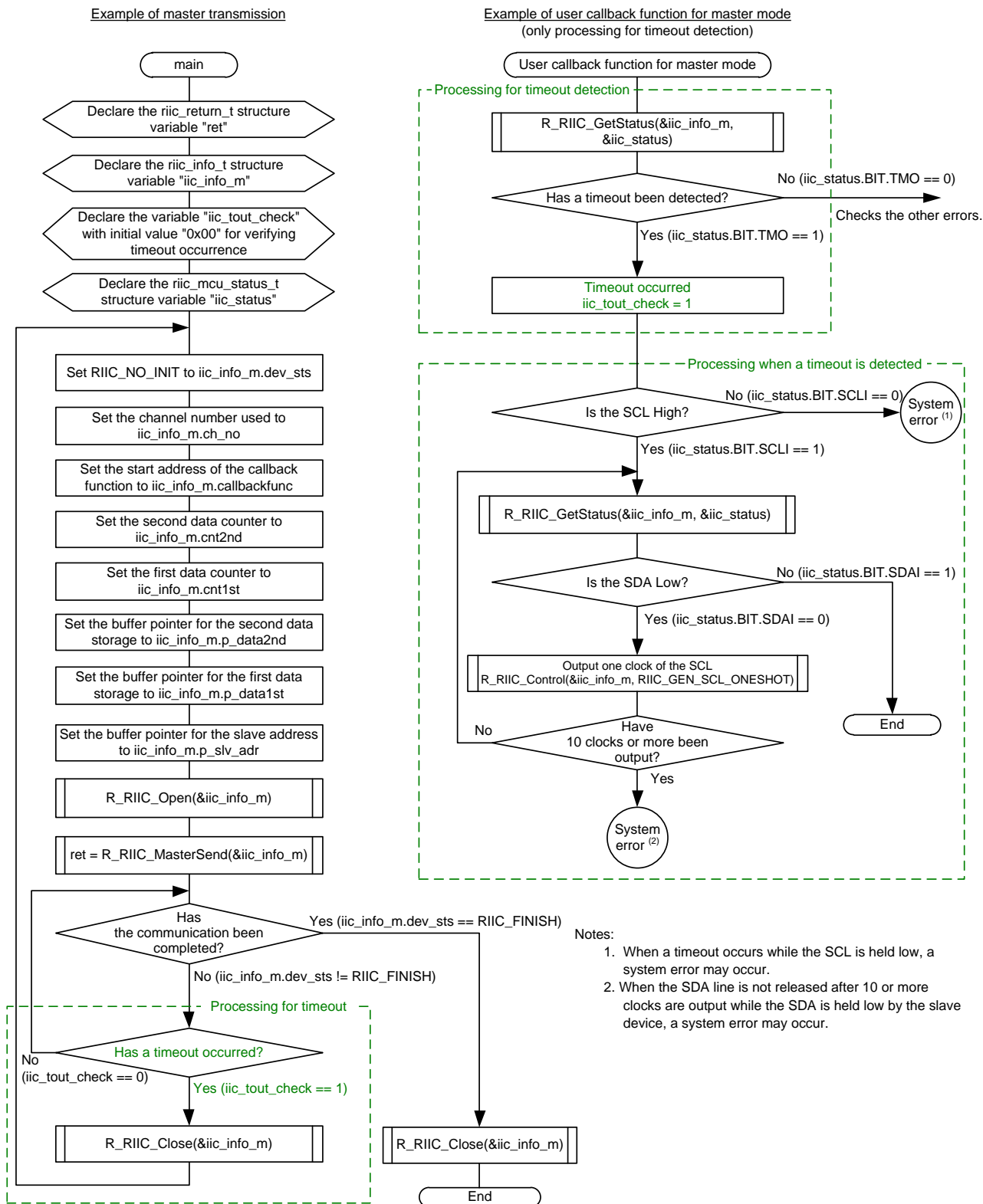

Figure 6.5 Timeout Detection and Processing After the Detection

## 6.4 Operating Test Environment

This section describes for detailed the operating test environments of this module.

**Table 6-6 Operation Test Environment for Rev.1.60 and Rev.1.70.**

Item	Contents
Integrated development environment	Renesas Electronics e <sup>2</sup> studio V3.1.0.024
C compiler	Renesas Electronics C/C++ compiler for RX Family V.2.01.01 Compiler options: The integrated development environment default settings are used, with the following option added. -lang = c99
Endian order	Big-endian/Little-endian
Module version	Rev.1.60 and Rev.1.70
Board used	Renesas Starter Kit for RX111 (product number. R0K505111SxxxBE) Renesas Starter Kit for RX231 (product number. R0K505231SxxxBE) Renesas Starter Kit+ for RX64M (product number. R0K50564MSxxxBE) Renesas Starter Kit+ for RX71M (product number. R0K50571MSxxxBE)

**Table 6-7 Operation Test Environment for Rev.1.80.**

Item	Contents
Integrated development environment	Renesas Electronics e <sup>2</sup> studio V4.0.2.008
C compiler	Renesas Electronics C/C++ compiler for RX Family V.2.03.00 Compiler options: The integrated development environment default settings are used, with the following option added. -lang = c99
Endian order	Big-endian/Little-endian
Module version	Rev.1.80
Board used	Renesas Starter Kit for RX130 (product number. RTK5005130SxxxxxBE) Renesas Starter Kit for RX23T (product number. RTK500523TSxxxxxBE)



## RX Family I<sup>2</sup>C Bus Interface (RIIC) Module Using Firmware Integration Technology

**Table 6-8 Operation Confirmation Environment for Rev.1.90.**

Item	Contents
Integrated development environment	Renesas Electronics e <sup>2</sup> studio V4.1.0.018
C compiler	Renesas Electronics C/C++ compiler for RX Family V.2.03.00 Compiler options: The integrated development environment default settings are used, with the following option added. -lang = c99
Endian order	Big-endian/Little-endian
Module version	Rev.1.90
Board used	Renesas Starter Kit for RX111 (product number. R0K505111SxxxBE) Renesas Starter Kit for RX113 (product number. R0K505113SxxxBE) Renesas Starter Kit for RX130 (product number. RTK5005130SxxxxxBE) Renesas Starter Kit for RX231 (product number. R0K505231SxxxBE) Renesas Starter Kit for RX23T (product number. RTK500523TSxxxxxBE) Renesas Starter Kit for RX24T (product number. RTK500524TSxxxxxBE) Renesas Starter Kit+ for RX64M (product number. R0K50564MSxxxBE) Renesas Starter Kit+ for RX71M (product number. R0K50571MSxxxBE)

**Table 6-9 Operation Confirmation Environment for Rev.2.00.**

Item	Contents
Integrated development environment	Renesas Electronics e <sup>2</sup> studio V5.0.1.005
C compiler	Renesas Electronics C/C++ compiler for RX Family V.2.05.00 Compiler options: The integrated development environment default settings are used, with the following option added. -lang = c99
Endian order	Big-endian/Little-endian
Module version	Rev.2.00
Board used	Renesas Starter Kit for RX231 (product number. R0K505231SxxxBE) Renesas Starter Kit+ for RX65N (product number. RTK500565NSxxxxxBE)

**Table 6-10 Operation Confirmation Environment for Rev.2.10.**

Item	Contents
Integrated development environment	Renesas Electronics e <sup>2</sup> studio V5.3.0.023
C compiler	Renesas Electronics C/C++ compiler for RX Family V.2.06.00 Compiler options: The integrated development environment default settings are used, with the following option added. -lang = c99
Endian order	Big-endian/Little-endian
Module version	Rev.2.10
Board used	Renesas Starter Kit for RX24T (product number. RTK500524TSxxxxxBE) Renesas Starter Kit for RX24U (product number. RTK500524USxxxxxBE)

## **RX Family I<sup>2</sup>C Bus Interface (RIIC) Module Using Firmware Integration Technology**

**Table 6-11 Operation Confirmation Environment for Rev.2.20.**

<b>Item</b>	<b>Contents</b>
Integrated development environment	Renesas Electronics e <sup>2</sup> studio V6.0.0.001
C compiler	Renesas Electronics C/C++ compiler for RX Family V.2.06.00 C/C++ compiler for RX Family V.2.07.00 Compiler options: The integrated development environment default settings are used, with the following option added. -lang = c99
Endian order	Big-endian/Little-endian
Module version	Rev.2.20
Board used	Renesas Starter Kit for RX130-512KB (product number. RTK5051308SxxxxxBE) Renesas Starter Kit+ for RX65N-2MB (product number. RTK50565N2SxxxxxBE)

**Table 6-12 Operation Confirmation Environment for Rev.2.30.**

<b>Item</b>	<b>Contents</b>
Integrated development environment	Renesas Electronics e <sup>2</sup> studio V7.0.0
C compiler	Renesas Electronics C/C++ compiler for RX Family V.3.00.00 Compiler options: The integrated development environment default settings are used, with the following option added. -lang = c99
Endian order	Big-endian/Little-endian
Module version	Rev.2.30
Board used	Renesas Starter Kit for RX66T (product number. RTK50566T0SxxxxxBE)

**Table 6-13 Operation Confirmation Environment for Rev.2.31.**

<b>Item</b>	<b>Contents</b>
Integrated development environment	Renesas Electronics e <sup>2</sup> studio V7.1.0
C compiler	Renesas Electronics C/C++ compiler for RX Family V.3.00.00 Compiler options: The integrated development environment default settings are used, with the following option added. -lang = c99
Endian order	Big-endian/Little-endian
Module version	Rev.2.31

## RX Family I<sup>2</sup>C Bus Interface (RIIC) Module Using Firmware Integration Technology

**Table 6-14 Operation Confirmation Environment for Rev.2.40.**

Item	Contents
Integrated development environment	Renesas Electronics e <sup>2</sup> studio V7.3.0
C compiler	Renesas Electronics C/C++ compiler for RX Family V.3.01.00 Compiler options: The integrated development environment default settings are used, with the following option added. -lang = c99
Endian order	Big-endian/Little-endian
Module version	Rev.2.40
Board used	Renesas Starter Kit for RX72T (product number. RTK5572Txxxxxxxxxx)

**Table 6-15 Operation Confirmation Environment for Rev.2.41.**

Item	Contents
Integrated development environment	Renesas Electronics e <sup>2</sup> studio V7.3.0 IAR Embedded Workbench for Renesas RX 4.10.01
C compiler	Renesas Electronics C/C++ Compiler Package for RX Family V.3.01.00 Compiler option: The following option is added to the default settings of the integrated development environment. -lang = c99 GCC for Renesas RX 4.08.04.201803 Compiler option: The following option is added to the default settings of the integrated development environment. -std=gnu99 IAR C/C++ Compiler for Renesas RX version 4.10.01 Compiler option: The default settings of the integrated development environment.
Endian order	Big-endian/Little-endian
Module version	Rev.2.41
Board used	Renesas Starter Kit+ for RX65N (product number. RTK500565Nxxxxxx)

**Table 6-16 Operation Confirmation Environment for Rev.2.42.**

Item	Contents
Integrated development environment	Renesas Electronics e <sup>2</sup> studio V7.2.0
C compiler	Renesas Electronics C/C++ compiler for RX Family V.3.01.00 Compiler options: The integrated development environment default settings are used, with the following option added. -lang = c99
Endian order	Big-endian/Little-endian
Module version	Rev.2.42
Board used	Renesas Solution Starter Kit for RX23W (product No.: RTK5523Wxxxxxxxxxx)

**Table 6-17 Operation Confirmation Environment for Rev.2.43.**

Item	Contents
Integrated development environment	Renesas Electronics e <sup>2</sup> studio V7.4.0 IAR Embedded Workbench for Renesas 4.12.01
C compiler	Renesas Electronics C/C++ Compiler Package for RX Family V.3.01.00 Compiler option: The following option is added to the default settings of the integrated development environment. -lang = c99
	GCC for Renesas RX 4.08.04.201902 Compiler option: The following option is added to the default settings of the integrated development environment. -std=gnu99
	IAR C/C++ Compiler for Renesas RX version 4.12.01 Compiler option: The default settings of the integrated development environment.
Endian order	Big-endian/Little-endian
Module version	Rev.2.43
Board used	Renesas Starter Kit+ for RX72M (product No.: RTK5572Mxxxxxxxxxx)

**Table 6-18 Operation Confirmation Environment for Rev.2.44.**

Item	Contents
Integrated development environment	Renesas Electronics e <sup>2</sup> studio V7.3.0 IAR Embedded Workbench for Renesas 4.12.01
C compiler	Renesas Electronics C/C++ Compiler Package for RX Family V.3.01.00 Compiler option: The following option is added to the default settings of the integrated development environment. -lang = c99
	GCC for Renesas RX 4.08.04.201902 Compiler option: The following option is added to the default settings of the integrated development environment. -std=gnu99
	IAR C/C++ Compiler for Renesas RX version 4.12.01 Compiler option: The default settings of the integrated development environment.
Endian order	Big-endian/Little-endian
Module version	Rev.2.44
Board used	RX13T CPU Card (product No.: RTK0EMXA10C00000BJ)

**Table 6-19 Operation Confirmation Environment for Rev.2.45.**

Item	Contents
Integrated development environment	Renesas Electronics e <sup>2</sup> studio 7.4.0 IAR Embedded Workbench for Renesas 4.12.01
C compiler	Renesas Electronics C/C++ Compiler Package for RX Family V.3.01.00 Compiler option: The following option is added to the default settings of the integrated development environment. -lang = c99
	GCC for Renesas RX 4.08.04.201902 Compiler option: The following option is added to the default settings of the integrated development environment. -std=gnu99
	IAR C/C++ Compiler for Renesas RX version 4.12.01 Compiler option: The default settings of the integrated development environment.
Endian order	Big-endian/Little-endian
Module version	Rev.2.45
Board used	Renesas Starter Kit+ for RX72N (product No.: RTK5572Nxxxxxxxxxx)

**Table 6-20 Operation Confirmation Environment for Rev.2.46.**

Item	Contents
Integrated development environment	Renesas Electronics e <sup>2</sup> studio 7.7.0 IAR Embedded Workbench for Renesas 4.13.01
C compiler	Renesas Electronics C/C++ Compiler Package for RX Family V.3.02.00 Compiler option: The following option is added to the default settings of the integrated development environment. -lang = c99
	GCC for Renesas RX 8.03.00.201904 Compiler option: The following option is added to the default settings of the integrated development environment. -std=gnu99
	IAR C/C++ Compiler for Renesas RX version 4.13.01 Compiler option: The default settings of the integrated development environment.
Endian order	Big-endian/Little-endian
Module version	Rev.2.46
Board used	Renesas Solution Starter Kit for RX23E-A (product No.: RTK0ESXB10C00001BJ)

**Table 6-21 Operation Confirmation Environment for Rev.2.47.**

Item	Contents
Integrated development environment	Renesas Electronics e <sup>2</sup> studio 2020-10 (20.10.0)
C compiler	Renesas Electronics C/C++ Compiler Package for RX Family V.3.02.00 Compiler option: The following option is added to the default settings of the integrated development environment. -lang = c99
Endian order	Big-endian/Little-endian
Module version	Rev.2.47
Board used	Renesas Starter Kit for RX231 (product number.: R0K505231SxxxBE) Renesas Starter Kit+ for RX64M (product number. R0K50564MSxxxBE)

**Table 6-22 Operation Confirmation Environment for Rev.2.48.**

Item	Contents
Integrated development environment	Renesas Electronics e <sup>2</sup> studio 2020-10 (20.10.0) IAR Embedded Workbench for Renesas 4.14.01
C compiler	Renesas Electronics C/C++ Compiler Package for RX Family V.3.03.00 Compiler option: The following option is added to the default settings of the integrated development environment. -lang = c99
	GCC for Renesas RX 8.03.00.202002 Compiler option: The following option is added to the default settings of the integrated development environment. -std=gnu99
	IAR C/C++ Compiler for Renesas RX version 4.14.01 Compiler option: The default settings of the integrated development environment.
Endian order	Big-endian/Little-endian
Module version	Rev.2.48
Board used	Renesas Starter Kit+ for RX671 (product number. RTK55671xxxxxxxxx)

### **6.5 Troubleshooting**

(1) Q: I have added the FIT module to the project and built it. Then I got the error: Could not open source file "platform.h".

A: The FIT module may not be added to the project properly. Check if the method for adding FIT modules is correct with the following documents:

- When using CS+:  
Application note "Adding Firmware Integration Technology Modules to CS+ Projects (R01AN1826)"
- When using e<sup>2</sup> studio:  
Application note "Adding Firmware Integration Technology Modules to Projects (R01AN1723)"

When using a FIT module, the board support package FIT module (BSP module) must also be added to the project. For this, refer to the application note "Board Support Package Module Using Firmware Integration Technology (R01AN1685)".

(2) Q: I have added the FIT module to the project and built it. Then I got the error: This MCU is not supported by the current r\_riic\_rx module.

A: The FIT module you added may not support the target device chosen in the user project. Check if the FIT module supports the target device for the project used.

(3) Q: I have added the FIT module to the project and built it. Then I got an error for when the configuration setting is wrong.

A: The setting in the file "r\_riic\_rx\_config.h" may be wrong. Check the file "r\_riic\_rx\_config.h". If there is a wrong setting, set the correct value for that. Refer to 2.7 Configuration Overview for details.

## 6.6 Sample Code

### 6.6.1 Example when Accessing One Slave Device Continuously with One Channel

This section describes an example of using one RIIC channel to continuously access to one slave device.

The procedure is as follows:

1. Execute the R\_RIIC\_Open function to use RIIC channel 0 in the RIIC FIT module.
2. Execute the R\_RIIC\_MasterSend function to write 16-byte data to EEPROM.
3. Performs Acknowledge Polling to wait for EEPROM write completion.
4. Execute the R\_RIIC\_MasterReceive function to write 16-byte data from EEPROM.
5. Compare write data with read data.
6. Execute the R\_RIIC\_Close function to release RIIC channel 0 from the RIIC FIT module.

This sample code is checked to operate with Renesas starter kit of target device. Please note that the address of the slave device depends on the EEPROM used.

```
#include <stddef.h>
#include "platform.h"
#include "r_riic_rx_if.h"

/* EEPROM device code (fixed) */
#define EEPROM_DEVICE_CODE (0xA0)

/* Device address code(under 4 bit is A2(Vss=0), A1(Vcc=1), A0(Vcc=1), and RW code)
for hardware connection with EEPROM on RSK of the supported target device.
Please change the following settings as necessary. */
#define EEPROM_DEVICE_ADDRESS_CODE (0x06)

/* EEPROM device address */
#define EEPROM_DEVICE_ADDRESS ((EEPROM_DEVICE_CODE | EEPROM_DEVICE_ADDRESS_CODE) >> 1)

/* variables */
static volatile riic_return_t ret; /* Return value */
static riic_info_t iic_info_m; /* Structure data */

static uint8_t addr_eeprom[1] = { EEPROM_DEVICE_ADDRESS };
static uint8_t access_addr1[1] = { 0x00 };

/* This data is sent to the EEPROM when target device is the master device. */
static uint8_t master_send_data[16] =
{ 0x80, 0x81, 0x82, 0x83, 0x84, 0x85, 0x86, 0x87, 0x88, 0x89, 0x8a, 0x8b, 0x8c, 0x8d, 0x8e,
0x8f };

/* This buffer stores data received from the slave device. */
static uint8_t master_store_area[16] =
{ 0xFF, 0xFF, 0xFF, 0xFF, 0xFF, 0xFF, 0xFF, 0xFF, 0xFF, 0xFF, 0xFF, 0xFF, 0xFF, 0xFF, 0xFF,
0xFF };

/* private functions */
static void callback_master (void);
static void eeprom_write (void);
static void acknowledge_polling (void);
static void eeprom_read (void);
```

**Figure 6.6 Example when Accessing One Slave Device Continuously with One Channel (1/5)**



```

/*****
 * Function Name: main
 * Description  : The main loop
 * Arguments   : none
 * Return Value: none
 *****/
void main (void)
{
    uint8_t i = 0;

    /* Initialize */
    for (i = 0; i < 16; i++)
    {
        master_store_area[i] = 0xFF;
    }

    /* Set arguments for R_RIIC_Open. */
    iic_info_m.ch_no = 0;          /* Channel number */
    iic_info_m.dev_sts = RIIC_NO_INIT; /* Device state flag (to be updated) */

    ret = R_RIIC_Open(&iic_info_m);
    if (RIIC_SUCCESS != ret)
    {
        /* This software is for single master.
           Therefore, return value should be always 'RIIC_SUCCESS'. */
        while (1)
        {
            R_BSP_NOP(); /* error */
        }
    }

    /* EEPROM Write (Master transfer) */
    eeprom_write();

    /* Acknowledge polling (Master transfer) */
    acknowledge_polling();

    /* EEPROM Read (Master transfer and Master receive) */
    eeprom_read();

    /* Compare */
    for (i = 0; i < 16; i++)
    {
        if (master_store_area[i] != master_send_data[i])
        {
            /* Detected mismatch. */
            LED3 = LED_ON;
        }
        else
        {
            LED0 = LED_ON;
        }
    }

    ret = R_RIIC_Close(&iic_info_m);
    if (RIIC_SUCCESS != ret)
    {
        /* This software is for single master.
           Therefore, return value should be always 'RIIC_SUCCESS'. */
        while (1)
        {
            R_BSP_NOP(); /* error */
        }
    }

    while (1)
    {
        /* do nothing */
    }
} /* End of function main() */

```

**Figure 6.7 Example when Accessing One Slave Device Continuously with One Channel (2/5)**

```

/*****
 * Function Name: callback_master
 * Description : This function is sample of Master Mode callback function.
 * Arguments : none
 * Return Value : none
 *****/
static void callback_master (void)
{
    riic_mcu_status_t iic_status;

    ret = R_RIIC_GetStatus(&iic_info_m, &iic_status);
    if (RIIC_SUCCESS != ret)
    {
        /* This software is for single master.
           Therefore, return value should be always 'RIIC_SUCCESS'. */
        while (1)
        {
            R_BSP_NOP(); /* error */
        }
    }
    else
    {
        /* Processing when a timeout, arbitration-lost, NACK,
           or others is detected by verifying the iic_status flag. */
    }
} /* End of function callback_master() */

/*****
 * Function Name: eeprom_write
 * Description : This function is sample of EEPROM write function using R_RIIC_MasterSend.
 * Arguments : none
 * Return Value : none
 *****/
static void eeprom_write (void)
{
    /* Set arguments for R_RIIC_MasterSend. */
    iic_info_m.p_slv_adr = addr_eeprom; /* Pointer to the slave address storage buffer */
    iic_info_m.p_data1st = access_addr1; /* Pointer to the first data storage buffer */
    iic_info_m.cnt1st = 1; /* First data counter (number of bytes)(to be updated) */
    iic_info_m.p_data2nd = master_send_data; /* Pointer to the second data storage buffer */
    iic_info_m.cnt2nd = 16; /* Second data counter (number of bytes)(to be updated) */
    iic_info_m.callbackfunc = &callback_master; /* Callback function */

    /* Master send start */
    ret = R_RIIC_MasterSend(&iic_info_m);
    if (RIIC_SUCCESS == ret)
    {
        /* Waitting for R_RIIC_MasterSend completed. */
        while (RIIC_COMMUNICATION == iic_info_m.dev_sts)
        {
            /* do nothing */
        }

        if (RIIC_NACK == iic_info_m.dev_sts)
        {
            /* Slave returns NACK. The slave address may not correct.
               Please check the macro definition value or hardware connection etc. */
            while (1)
            {
                R_BSP_NOP(); /* error */
            }
        }
    }
    else
    {
        /* This software is for single master.
           Therefore, return value should be always 'RIIC_SUCCESS'. */
        while (1)
        {
            R_BSP_NOP(); /* error */
        }
    }
}

```

**Figure 6.8 Example when Accessing One Slave Device Continuously with One Channel (3/5)**

```

    }
}

} /* End of function eeprom_write() */

/*****
 * Function Name: acknowledge_polling
 * Description  : This function is sample of Acknowledge Polling using R_RIIC_MasterSend with
 *               master send pattern 3.
 * Arguments    : none
 * Return Value : none
 *****/
static void acknowledge_polling (void)
{
    do
    {
        /* Set arguments for R_RIIC_MasterSend. */
        iic_info_m.p_slv_adr = addr_eeprom; /* Pointer to the slave address storage buffer */
        iic_info_m.p_data1st = (uint8_t*) FIT_NO_PTR; /* Pointer to the first data storage buffer
*/
        iic_info_m.cnt1st = 0; /* First data counter (number of bytes) */
        iic_info_m.p_data2nd = (uint8_t*) FIT_NO_PTR; /* Pointer to the second data storage buffer
*/
        iic_info_m.cnt2nd = 0; /* Second data counter (number of bytes) */
        iic_info_m.callbackfunc = &callback_master; /* Callback function */

        /* Master send start. */
        ret = R_RIIC_MasterSend(&iic_info_m);
        if (RIIC_SUCCESS == ret)
        {
            /* Waitting for R_RIIC_MasterSend completed. */
            while (RIIC_COMMUNICATION == iic_info_m.dev_sts)
            {
                /* do nothing */
            }

            /* Slave returns NACK. Set retry interval. */
            if (RIIC_NACK == iic_info_m.dev_sts)
            {
                /* Waitting for retry interval 100us. */
                R_BSP_SoftwareDelay(100, BSP_DELAY_MICROSECS);
            }
        }
        else
        {
            /* This software is for single master.
            Therefore, return value should be always 'RIIC_SUCCESS'. */
            while (1)
            {
                R_BSP_NOP(); /* error */
            }
        }
    } while (RIIC_FINISH != iic_info_m.dev_sts);
} /* End of function acknowledge_polling() */

```

**Figure 6.9 Example when Accessing One Slave Device Continuously with One Channel (4/5)**

```

/*****
* Function Name: eeprom_read
* Description : This function is sample of EEPROM read function using R_RIIC_MasterReceive.
* Arguments   : none
* Return Value : none
*****/
static void eeprom_read (void)
{
    /* Set arguments for R_RIIC_MasterReceive. */
    iic_info_m.p_slv_addr = addr_eeprom;          /* Pointer to the slave address storage buffer */
    iic_info_m.p_data1st = access_addr1;        /* Pointer to the first data storage buffer */
    iic_info_m.cnt1st = 1;                      /* First data counter (number of bytes)(to be updated) */
    iic_info_m.p_data2nd = master_store_area;   /* Pointer to the second data storage buffer */
    iic_info_m.cnt2nd = 16;                    /* Second data counter (number of bytes)(to be updated) */
    iic_info_m.callbackfunc = &callback_master; /* Callback function */

    /* Master send receive start. */
    ret = R_RIIC_MasterReceive(&iic_info_m);
    if (RIIC_SUCCESS == ret)
    {
        /* Waiting for R_RIIC_MasterSend completed. */
        while (RIIC_COMMUNICATION == iic_info_m.dev_sts)
        {
            /* do nothing */
        }

        if (RIIC_NACK == iic_info_m.dev_sts)
        {
            /* Slave returns NACK. The slave address may not correct.
             Please check the macro definition value or hardware connection etc. */
            while (1)
            {
                R_BSP_NOP(); /* error */
            }
        }
    }
    else
    {
        /* This software is for single master.
         Therefore, return value should be always 'RIIC_SUCCESS'. */
        while (1)
        {
            R_BSP_NOP(); /* error */
        }
    }
} /* End of function eeprom_read() */

```

**Figure 6.10 Example when Accessing One Slave Device Continuously with One Channel (5/5)**

### **7. Reference Documents**

#### User's Manual: Hardware

The latest version can be downloaded from the Renesas Electronics website.

#### Technical Update/Technical News

The latest information can be downloaded from the Renesas Electronics website.

#### User's Manual: Development Tools

RX Family Compiler CC-RX User's Manual (R20UT3248)

The latest versions can be downloaded from the Renesas Electronics website.

### **Related Technical Updates**

This module reflects the content of the following technical updates.

- TN-RX\*-A012A/E

## Revision History

Rev.	Date	Description	
		Page	Summary
1.00	Aug. 1, 2013	-	First edition issued
1.10	Sep. 30, 2013	-	Modified return values.
1.20	Nov. 15, 2013	4	Limitations: Changed the interrupt size to 120 bytes in (6).
		5	Table 1.2 Required Memory Size: - Changed the Size for the ROM to 7340 bytes. - Changed the Size for the Maximum interrupt stack usage to 120 bytes.
		47	Figure 4.2 State Transition on Master Transmission (R_RIIC_MasterSend() Called): - Added an arrow to indicate EV7 from STS8 to STS2. - Modified the comment on the arrow from STS8 to STS1.
		48	Figure 4.3 State Transition on Master Reception (R_RIIC_MasterReceive() Called): - Added an arrow to indicate EV7 from STS8 to STS2. - Modified the comment on the arrow from STS8 to STS1.
1.30	Apr. 1, 2014	-	Added support for the RX100 Series.
1.40	Oct. 1, 2014	1	Target Device: Changed from the RX100 Series to the RX111, RX110 and RX64M Groups. Related Documents: Added.
		4	1. Overview: - Features supported by this module: Added the description regarding channel 0 of RX64M in the third item. - Limitations: - Added the DMAC to (1) as the module not supported with this module. - Deleted (2), (5) and (6) in rev.1.30. - Added (5) to (7).
		5	Table 1.2 Required Memory Size: Changed the memory sizes.
		18	Figure 1.14 RIIC FIT Module State Transition Diagram: Added "RIIC_TMO" in the Error state.
		19	Table 1.2 Device State Flags when Transitioning States: Added "Timeout detection state".
		20	1.3.8 Timeout Detection Function: Added.
		21	2.2 Software Requirements: Deleted "r_cgc_rx".
		22 to 26	2.6 Configuration Overview: - Added parameters for CH2. - Changed the explanation of the following parameters: RIIC_CFG_CH0_KBPS, RIIC_CFG_CH0_SCL0, RIIC_CFG_CH0_SDA0 - Deleted the parameter "RIIC_CFG_PCLK_Hz". - Deleted the parameter "RIIC_CFG_CH0_INT_PRIORITY" and added separated parameters for RXI, TXI, EEI, and TEI (e.g. RIIC_CFG_CH0_RXI_INT_PRIORITY). - Added parameters regarding timeout detection. - Added note 1.
		27	2.7 Parameters: Added the description regarding the limitation of rewriting the structure. 2.8 Return Values: Added "RIIC_ERR_TMO".
		29	3.1 R_RIIC_Open(): Added the limitation of rewriting the structure to the explanation in the Parameters.

## RX Family I<sup>2</sup>C Bus Interface (RIIC) Module Using Firmware Integration Technology

Rev.	Date	Description	
		Page	Summary
1.40	Oct. 1, 2014	31 to 39	3.2 R_RIIC_MasterSend(), 3.3 R_RIIC_MasterReceive(), and 3.4 R_RIIC_SlaveTransfer(): - Parameters: Added the limitation of rewriting the structure to the explanation. - Return Values: Added "RIIC_ERR_TMO". - Example: Changed the code in the CallbackMaster function. - Special Notes (3.4 only): Changed description in the Notes.
		40, 41	3.5 R_RIIC_GetStatus(): - Changed the structure members of "riic_mcu_status_t". - Changed the flag allocation table in the Special Notes.
		42	3.6 R_RIIC_Control(): - Parameters: Added the limitation of rewriting the structure to the explanation. - Special Notes: Added "One-shot output of the SCL clock".
		44	3.7 R_RIIC_Close(): Added the limitation of rewriting the structure to the explanation in the Parameters.
		47 to 60	4. Appendices: Changed symbols for interrupt names "ICEEI", "ICTEI", "ICRXI" and "ICTXI" to "EEI", "TEI", "RXI" and "TXI", respectively.
		47	Table 4.1 States Used for Protocol Control: Added state STS10 "RIIC_STS_TMO".
			Table 4.2 Events Used for Protocol Control: - Added EV10 "RIIC_EV_INT_TMO".
		49, 50	Figure 4.2 State Transition on Master Transmission and Figure 4.3 State Transition on Master Reception: - Added descriptions regarding state STS10 (RIIC_STS_TMO). - Deleted the arrow from STS8 to STS9.
		51	Figure 4.4 State Transition on Slave Transmission and Reception: Deleted descriptions regarding STS9 (RIIC_STS_AL).
		52	Table 4.3 Protocol State Transition Table: - Added the column for EV10 and the row for STS10. - Changed "FuncA" to "Func10".
		53	Table 4.4 Functions Used on Protocol State Transition: - Changed "FuncA" to "Func10". - Added the row for Func11 "riic_time_out()".
		54	Table 4.5 States of Flags on State Transitions: - Added "RIIC_STS_TMO" for all the "Communicating" states. - Deleted "RIIC_STS_AL" from the "Communicating (slave transmission/reception)" states. - Added the row for "Timeout detection state".
		55 to 58	4.2 Interrupt Request Generation Timing: - Deleted notes 1 and 2.
		57	4.2.4 Slave Transmission: - When transmitting 2-byte data: Added "5: EEI (STOP) interrupt". - When transmitting 3-byte data: Added "4: TXI interrupt".
		58	4.2.6 Multi-Master Communication: Added.
		59, 60	4.3 Timeout Detection and Processing After the Detection: Added including Figure 4.5. .
61	6. Reference Documents: Changed reference documents in the		



## RX Family I<sup>2</sup>C Bus Interface (RIIC) Module Using Firmware Integration Technology

			User's Manual: Development Tools.
Rev.	Date	Description	
		Page	Summary
1.40	Oct. 1, 2014	Program	<p>The module is updated to fix the software issue.</p> <p><u>Description:</u> Slave communication is not available after an arbitration-lost occurs, and then the bus is locked.</p> <p><u>Conditions:</u> The issue occurs when the following four conditions are all met.</p> <ul style="list-style-type: none"> <li>- RIIC FIT module rev. 1.30 or earlier is used.</li> <li>- RX device operates as both the master and the slave in multi-master communication.</li> <li>- An arbitration-lost is detected when communicating as the master.</li> <li>- Communication other than master reception or slave reception is performed.</li> </ul> <p><u>Measure:</u> Please use the RIIC FIT module Rev. 1.40.</p>
1.50	Dec. 1, 2014	-	Added support for the RX113 Group.
1.60	Dec. 15, 2014	-	Added support for the RX71M Group.
1.70	Dec. 15, 2014	-	Added support for the RX231 Group.
1.80	Oct. 31, 2015	-	Added support for the RX130 Group, RX230 Group, RX23T Group.
		34	Example of 3.2, R_RIIC_MasterSend(), modified
		37, 38	Example of 3.3, R_RIIC_MasterReceive(), modified
		40, 41	Example of 3.4, R_RIIC_SlaveTransfer(), modified
1.90	Mar. 4, 2016	-	Added support for the RX24T Group.
		5	Table 1.2 Required Memory Size, changed.
		22, 28	Added description of r_riic_rx_pin_config.h to section 2.6, Configuration Overview.
		-	Changed "master composite" to "master transmit/receive".
2.00	Oct 1, 2016	-	Added support for the RX65N Group.
		29	Changed code size description from "Table 1.2 Required Memory Size" to "2.7 Code Size."
		Program	<p>Corrected an error of the definitions "RIIC_IR_RXI2" and "RIIC_IR_TXI2" to refer the RXI, and TXI Interrupt Status Flag of channel 2.</p> <p>The module is updated to fix the software issue.</p> <p><u>Description:</u> Since there is an error in the handling of pin function settings of RX110 in Rev.1.90, build error occurs if use RX110.</p> <p><u>Conditions:</u> When you build the project, after create a new project with selected "RX110" series device as MCU, and added RIIC FIT module Rev.1.90 in reference to "2.10 Adding the FIT Module to Your Project".</p> <p><u>Corrective action:</u> Corrected the handling pin function settings by function riic_mcu_mpc_enable() and riic_mcu_mpc_disable(). Please use the RIIC FIT module Rev.2.00.</p>

## RX Family I<sup>2</sup>C Bus Interface (RIIC) Module Using Firmware Integration Technology

Rev.	Date	Description	
		Page	Summary
2.10	Jun 2, 2017	-	Added RX24U Group in the Target Device.
		-	Added support for the RX24T-512KB version.
		22	2.4. Usage of Interrupt Vector: Added.
		32	2.11. Callback Functions: Added.
			2.12. Adding the FIT Module to Your Project: Changed.
		52	4. Pin Settings: Added.
		69 to 70	5.4. Operating Test Environment: Added.
72	5.5. Troubleshooting: Added.		
2.20	Aug. 31, 2017	-	Added support for the RX65N-2MB version.
		-	Added support for the RX130-512KB version.
		1	Related Documents: Added the following document: "Renesas e <sup>2</sup> studio Smart Configurator User Guide (R20AN0451)"
		22	2.4. Usage of Interrupt Vector: Revised. Interrupt vector used in RX65N-2MB added to the Table 2.1. Interrupt Vector used in the RIIC FIT Module.
		24	2.7. Configuration Overview: Changed the description for RIIC_CFG_PORT_SET_PROCESSING.
		24 to 27	2.7. Configuration Overview: Added definitions for Channel 1.
		32	2.12. Adding the FIT Module to Your Project: Revised.
		52	4. Pin Settings: Revised.
		70	Table 5.11. Operation Test Environment for Rev.2.20, added.
		72 to 76	5.6. Sample Code: Added.
		77	6. Provided Modules: Deleted.
Program	Added definitions for Channel 1.		
2.30	Sep. 20, 2018	-	Added support for the RX66T Group.
		21	2.3. Supported Toolchains Added for Toolchain v.3.00.00
		22	2.4. Usage of Interrupt Vector: Revised. Interrupt vector used in RX66T added to the Table 2.1. Interrupt Vector used in the RIIC FIT Module.
		29	2.8. Code Size: Changed code size for Rev2.30
		32	2.13 "for", "while" and "do while" statements: added
		55 to 56	5.Demo Projects: Added
		-	Change 5.Appendices to 6.Appendices All file: Chapter 5 related number is changed to 6
		73	Table 6-12. Operation Test Environment for Rev.2.30, added.
2.31	Dec. 03, 2018	73	6.4 Operation Confirmation Environment: Corrected board used in Table 6.12 Confirmed Operation Environment (Rev. 2.30). Added Table 6.13 Confirmed Operation Environment (Rev. 2.31).
		Program	Added document number of the application note accompanying the sample program of the FIT module to xml file.

## RX Family I<sup>2</sup>C Bus Interface (RIIC) Module Using Firmware Integration Technology

Rev.	Date	Description	
		Page	Summary
2.40	Feb. 20, 2019	-	Added support for the RX72T Group.
		1	Related Documents: Changed the following documents' names RX Family Board Support Package Module Using Firmware Integration Technology (R01AN1685) RX Family Adding Firmware Integration Technology Modules to Projects (R01AN1723) RX Family Adding Firmware Integration Technology Modules to CS+ Projects (R01AN1826)
		21	2.3. Supported Toolchains Added for Toolchain v.3.01.00
		22	2.4. Usage of Interrupt Vector: Revised. Interrupt vector used in RX72T added to the Table 2.1. Interrupt Vector used in the RIIC FIT Module.
		74	Table 6-14. Operation Test Environment for Rev.2.40, added.
2.41	May. 20, 2019	-	Update the following compilers GCC for Renesas RX IAR C/C++ Compiler for Renesas RX
		1	Deleted Related Documents. Added Target Compilers.
		21	Added revision of dependent r_bsp module in 2.2 Software Requirements.
		29	2.8 Code Size, amended
		53	3.8 R_RIIC_GetVersion function, deleted special notes.
		74	Table 6-15. Operation Test Environment for Rev.2.41, added.
		77	Changed nop to BSP's built in function.
2.42	Jun. 20, 2019	-	Added support for the RX23W Group.
		22	Table 2.1 Interrupt Vector used in the RIIC FIT Module, added RX23W.
		29	2.8 Code Size, amended.
		74	Table 6-16. Operation Confirmation Environment for Rev.2.42, added.
2.43	Jul. 30, 2019	-	Added support for the RX72M Group.
		22	2.4. Usage of Interrupt Vector: Revised. Interrupt vector used in RX72M added to the Table 2.1. Interrupt Vector used in the RIIC FIT Module.
		24	2.7. Configuration Overview Changed.
		29	Changed Section 2.8 Code Size.
		34 to 53	Delete "Reentrant" item on the API description page.
		75	Table 6-17. Operation Test Environment for Rev.2.43, added.
2.44	Oct. 10, 2019	-	Added support for the RX13T Group.
		22	2.4. Usage of Interrupt Vector: Revised. Interrupt vector used in RX13T added to the Table 2.1. Interrupt Vector used in the RIIC FIT Module.
		29	Changed Section 2.8 Code Size.
		75	Table 6-18. Operation Test Environment for Rev.2.44, added.

## RX Family I<sup>2</sup>C Bus Interface (RIIC) Module Using Firmware Integration Technology

Rev.	Date	Description	
		Page	Summary
2.45	Nov. 22. 2019	-	Added support for the RX72N and RX66N Group.
		4	1.Overview Changed
		22	2.4. Usage of Interrupt Vector: Revised. Interrupt vector used in RX72N and RX66N added to the Table 2.1. Interrupt Vector used in the RIIC FIT Module.
		24	2.7. Configuration Overview Changed.
		29	Changed Section 2.8 Code Size.
		57	6.1.2 Events During API Operation: Added notes to EV4 and EV5 in Table 6.2 Events Used for Protocol Control (enum r_riic_api_event_t).
		60	6.1.3 Protocol State Transitions: Corrected Figure 6.3 State Transition on Master Reception (R_RIIC_MasterReceive() Called).
		62	6.1.4 Protocol State Transitions: Corrected Table 6.3 State Transition Table (gc_riic_mtx_tbl[[]]).
76	Table 6-19. Operation Test Environment for Rev.2.45, added.		
2.46	Mar. 10. 2020	-	Added support for the RX23E-A Group.
		21	2.3 Supported Toolchains Added for Toolchain v.3.02.00
		23	2.4. Usage of Interrupt Vector: Revised. Interrupt vector used in RX23E-A added to the Table 2.1. Interrupt Vector used in the RIIC FIT Module.
		30	Changed Section 2.8 Code Size.
		32	Changed Section 2.12 Adding the FIT Module to Your Project.
		77	Table 6-20. Operation Test Environment for Rev.2.46, added.
2.47	Oct. 30. 2020	-	Updated the sample code project due to the upgrade of the development environment.
2.48	Jun. 30. 2021	-	Added support for the RX671 Group.
		4	1.Overview Changed
		21	2.3 Supported Toolchains Added for Toolchain v.3.03.00
		23	2.4. Usage of Interrupt Vector: Revised. Interrupt vector used in RX671 added to the Table 2.1. Interrupt Vector used in the RIIC FIT Module.
		30	Changed Section 2.8 Code Size.
		78	Table 6-22. Operation Test Environment for Rev.2.48, added.

## General Precautions in the Handling of Microprocessing Unit and Microcontroller Unit Products

The following usage notes are applicable to all Microprocessing unit and Microcontroller unit products from Renesas. For detailed usage notes on the products covered by this document, refer to the relevant sections of the document as well as any technical updates that have been issued for the products.

### 1. Precaution against Electrostatic Discharge (ESD)

A strong electrical field, when exposed to a CMOS device, can cause destruction of the gate oxide and ultimately degrade the device operation. Steps must be taken to stop the generation of static electricity as much as possible, and quickly dissipate it when it occurs. Environmental control must be adequate. When it is dry, a humidifier should be used. This is recommended to avoid using insulators that can easily build up static electricity.

Semiconductor devices must be stored and transported in an anti-static container, static shielding bag or conductive material. All test and measurement tools including work benches and floors must be grounded. The operator must also be grounded using a wrist strap. Semiconductor devices must not be touched with bare hands. Similar precautions must be taken for printed circuit boards with mounted semiconductor devices.

### 2. Processing at power-on

The state of the product is undefined at the time when power is supplied. The states of internal circuits in the LSI are indeterminate and the states of register settings and pins are undefined at the time when power is supplied. In a finished product where the reset signal is applied to the external reset pin, the states of pins are not guaranteed from the time when power is supplied until the reset process is completed. In a similar way, the states of pins in a product that is reset by an on-chip power-on reset function are not guaranteed from the time when power is supplied until the power reaches the level at which resetting is specified.

### 3. Input of signal during power-off state

Do not input signals or an I/O pull-up power supply while the device is powered off. The current injection that results from input of such a signal or I/O pull-up power supply may cause malfunction and the abnormal current that passes in the device at this time may cause degradation of internal elements. Follow the guideline for input signal during power-off state as described in your product documentation.

### 4. Handling of unused pins

Handle unused pins in accordance with the directions given under handling of unused pins in the manual. The input pins of CMOS products are generally in the high-impedance state. In operation with an unused pin in the open-circuit state, extra electromagnetic noise is induced in the vicinity of the LSI, an associated shoot-through current flows internally, and malfunctions occur due to the false recognition of the pin state as an input signal become possible.

### 5. Clock signals

After applying a reset, only release the reset line after the operating clock signal becomes stable. When switching the clock signal during program execution, wait until the target clock signal is stabilized. When the clock signal is generated with an external resonator or from an external oscillator during a reset, ensure that the reset line is only released after full stabilization of the clock signal. Additionally, when switching to a clock signal produced with an external resonator or by an external oscillator while program execution is in progress, wait until the target clock signal is stable.

### 6. Voltage application waveform at input pin

Waveform distortion due to input noise or a reflected wave may cause malfunction. If the input of the CMOS device stays in the area between  $V_{IL}$  (Max.) and  $V_{IH}$  (Min.) due to noise, for example, the device may malfunction. Take care to prevent chattering noise from entering the device when the input level is fixed, and also in the transition period when the input level passes through the area between  $V_{IL}$  (Max.) and  $V_{IH}$  (Min.).

### 7. Prohibition of access to reserved addresses

Access to reserved addresses is prohibited. The reserved addresses are provided for possible future expansion of functions. Do not access these addresses as the correct operation of the LSI is not guaranteed.

### 8. Differences between products

Before changing from one product to another, for example to a product with a different part number, confirm that the change will not lead to problems. The characteristics of a microprocessing unit or microcontroller unit products in the same group but having a different part number might differ in terms of internal memory capacity, layout pattern, and other factors, which can affect the ranges of electrical characteristics, such as characteristic values, operating margins, immunity to noise, and amount of radiated noise. When changing to a product with a different part number, implement a system-evaluation test for the given product.

## Notice

1. Descriptions of circuits, software and other related information in this document are provided only to illustrate the operation of semiconductor products and application examples. You are fully responsible for the incorporation or any other use of the circuits, software, and information in the design of your product or system. Renesas Electronics disclaims any and all liability for any losses and damages incurred by you or third parties arising from the use of these circuits, software, or information.
2. Renesas Electronics hereby expressly disclaims any warranties against and liability for infringement or any other claims involving patents, copyrights, or other intellectual property rights of third parties, by or arising from the use of Renesas Electronics products or technical information described in this document, including but not limited to, the product data, drawings, charts, programs, algorithms, and application examples.
3. No license, express, implied or otherwise, is granted hereby under any patents, copyrights or other intellectual property rights of Renesas Electronics or others.
4. You shall be responsible for determining what licenses are required from any third parties, and obtaining such licenses for the lawful import, export, manufacture, sales, utilization, distribution or other disposal of any products incorporating Renesas Electronics products, if required.
5. You shall not alter, modify, copy, or reverse engineer any Renesas Electronics product, whether in whole or in part. Renesas Electronics disclaims any and all liability for any losses or damages incurred by you or third parties arising from such alteration, modification, copying or reverse engineering.
6. Renesas Electronics products are classified according to the following two quality grades: "Standard" and "High Quality". The intended applications for each Renesas Electronics product depends on the product's quality grade, as indicated below.

"Standard": Computers; office equipment; communications equipment; test and measurement equipment; audio and visual equipment; home electronic appliances; machine tools; personal electronic equipment; industrial robots; etc.

"High Quality": Transportation equipment (automobiles, trains, ships, etc.); traffic control (traffic lights); large-scale communication equipment; key financial terminal systems; safety control equipment; etc.

Unless expressly designated as a high reliability product or a product for harsh environments in a Renesas Electronics data sheet or other Renesas Electronics document, Renesas Electronics products are not intended or authorized for use in products or systems that may pose a direct threat to human life or bodily injury (artificial life support devices or systems; surgical implantations; etc.), or may cause serious property damage (space system; undersea repeaters; nuclear power control systems; aircraft control systems; key plant systems; military equipment; etc.). Renesas Electronics disclaims any and all liability for any damages or losses incurred by you or any third parties arising from the use of any Renesas Electronics product that is inconsistent with any Renesas Electronics data sheet, user's manual or other Renesas Electronics document.
7. No semiconductor product is absolutely secure. Notwithstanding any security measures or features that may be implemented in Renesas Electronics hardware or software products, Renesas Electronics shall have absolutely no liability arising out of any vulnerability or security breach, including but not limited to any unauthorized access to or use of a Renesas Electronics product or a system that uses a Renesas Electronics product. RENESAS ELECTRONICS DOES NOT WARRANT OR GUARANTEE THAT RENESAS ELECTRONICS PRODUCTS, OR ANY SYSTEMS CREATED USING RENESAS ELECTRONICS PRODUCTS WILL BE INVULNERABLE OR FREE FROM CORRUPTION, ATTACK, VIRUSES, INTERFERENCE, HACKING, DATA LOSS OR THEFT, OR OTHER SECURITY INTRUSION ("Vulnerability Issues"). RENESAS ELECTRONICS DISCLAIMS ANY AND ALL RESPONSIBILITY OR LIABILITY ARISING FROM OR RELATED TO ANY VULNERABILITY ISSUES. FURTHERMORE, TO THE EXTENT PERMITTED BY APPLICABLE LAW, RENESAS ELECTRONICS DISCLAIMS ANY AND ALL WARRANTIES, EXPRESS OR IMPLIED, WITH RESPECT TO THIS DOCUMENT AND ANY RELATED OR ACCOMPANYING SOFTWARE OR HARDWARE, INCLUDING BUT NOT LIMITED TO THE IMPLIED WARRANTIES OF MERCHANTABILITY, OR FITNESS FOR A PARTICULAR PURPOSE.
8. When using Renesas Electronics products, refer to the latest product information (data sheets, user's manuals, application notes, "General Notes for Handling and Using Semiconductor Devices" in the reliability handbook, etc.), and ensure that usage conditions are within the ranges specified by Renesas Electronics with respect to maximum ratings, operating power supply voltage range, heat dissipation characteristics, installation, etc. Renesas Electronics disclaims any and all liability for any malfunctions, failure or accident arising out of the use of Renesas Electronics products outside of such specified ranges.
9. Although Renesas Electronics endeavors to improve the quality and reliability of Renesas Electronics products, semiconductor products have specific characteristics, such as the occurrence of failure at a certain rate and malfunctions under certain use conditions. Unless designated as a high reliability product or a product for harsh environments in a Renesas Electronics data sheet or other Renesas Electronics document, Renesas Electronics products are not subject to radiation resistance design. You are responsible for implementing safety measures to guard against the possibility of bodily injury, injury or damage caused by fire, and/or danger to the public in the event of a failure or malfunction of Renesas Electronics products, such as safety design for hardware and software, including but not limited to redundancy, fire control and malfunction prevention, appropriate treatment for aging degradation or any other appropriate measures. Because the evaluation of microcomputer software alone is very difficult and impractical, you are responsible for evaluating the safety of the final products or systems manufactured by you.
10. Please contact a Renesas Electronics sales office for details as to environmental matters such as the environmental compatibility of each Renesas Electronics product. You are responsible for carefully and sufficiently investigating applicable laws and regulations that regulate the inclusion or use of controlled substances, including without limitation, the EU RoHS Directive, and using Renesas Electronics products in compliance with all these applicable laws and regulations. Renesas Electronics disclaims any and all liability for damages or losses occurring as a result of your noncompliance with applicable laws and regulations.
11. Renesas Electronics products and technologies shall not be used for or incorporated into any products or systems whose manufacture, use, or sale is prohibited under any applicable domestic or foreign laws or regulations. You shall comply with any applicable export control laws and regulations promulgated and administered by the governments of any countries asserting jurisdiction over the parties or transactions.
12. It is the responsibility of the buyer or distributor of Renesas Electronics products, or any other party who distributes, disposes of, or otherwise sells or transfers the product to a third party, to notify such third party in advance of the contents and conditions set forth in this document.
13. This document shall not be reprinted, reproduced or duplicated in any form, in whole or in part, without prior written consent of Renesas Electronics.
14. Please contact a Renesas Electronics sales office if you have any questions regarding the information contained in this document or Renesas Electronics products.

(Note1) "Renesas Electronics" as used in this document means Renesas Electronics Corporation and also includes its directly or indirectly controlled subsidiaries.

(Note2) "Renesas Electronics product(s)" means any product developed or manufactured by or for Renesas Electronics.

(Rev.5.0-1 October 2020)

## Corporate Headquarters

TOYOSU FORESIA, 3-2-24 Toyosu,  
Koto-ku, Tokyo 135-0061, Japan  
[www.renesas.com](http://www.renesas.com)

## Trademarks

Renesas and the Renesas logo are trademarks of Renesas Electronics Corporation. All trademarks and registered trademarks are the property of their respective owners.

## Contact information

For further information on a product, technology, the most up-to-date version of a document, or your nearest sales office, please visit:  
[www.renesas.com/contact/](http://www.renesas.com/contact/).